



**Wichtig:**  
Vor Gebrauch sorgfältig durchlesen/  
Montageanleitung für  
späteres Nachlesen  
aufbewahren

**Important:**  
Lisez attentivement/  
conserver les instructions  
d'installation  
pour référence future  
avant utilisation

**Importante:**  
lettura/conservare  
Istruzioni per l'installa-  
zione per riferimento  
futuro accuratamente  
prima dell'uso

**Important:**  
Read carefully before  
assembling/keep and  
store Instruction for  
reference

# ELLIS

Art.4074.269.000.00

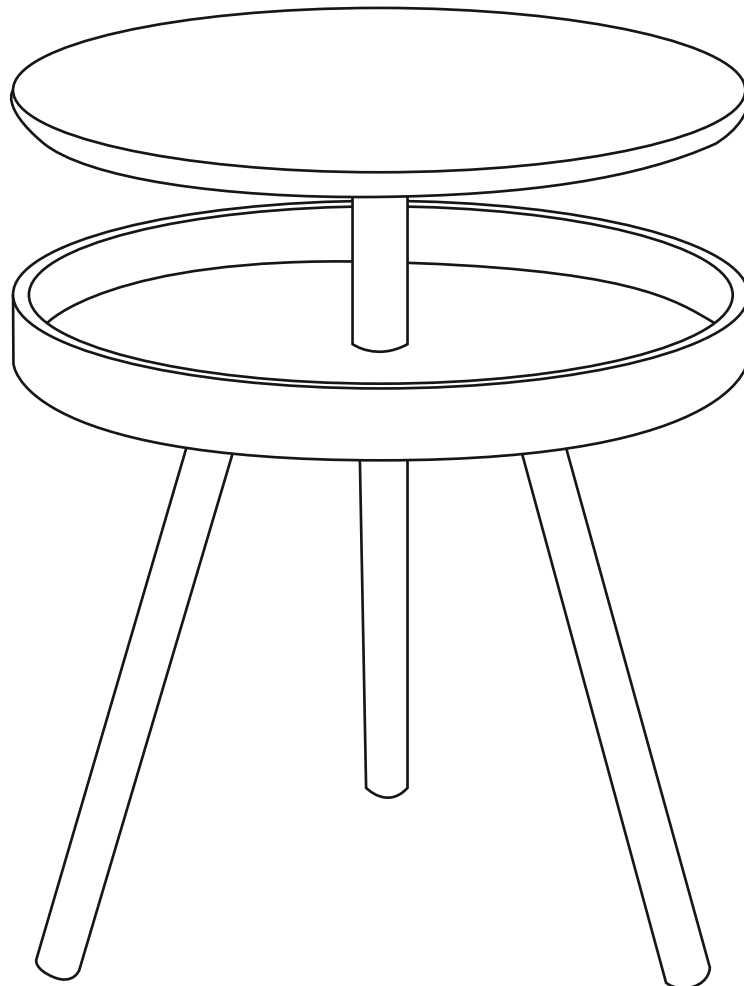



## Warnhinweise

### Bestimmungsgemässer Gebrauch:

Bitte achten Sie darauf, dass Ihre Möbel nur Ihrem Zweck gemäss verwendet werden. Für eine dauerhafte Funktionsfähigkeit, ist eine sachgerechte Nutzung und regelmässige Unterhaltspflege sehr wichtig.

## Mises en garde

### Utilisation conforme:

Veillez vous assurer que vos meubles sont utilisés uniquement pour leur usage prévu. Un entretien régulier et une utilisation conforme sont essentiels pour assurer un fonctionnement durable.

## Avvertenze

### Utilizzo per lo scopo previsto:

assicuratevi che i vostri mobili siano utilizzati solo per lo scopo per cui sono stati realizzati. Per garantire il loro funzionamento nel tempo è importante utilizzarli correttamente e sottoporli regolarmente a cure manutentive.

## Warning notice

### Intended use:

Please make sure that you only use your furniture for the purpose it was designed for. Correct use and regular maintenance are essential for ensuring your furniture remains in working order for the long-term.

	<p><b>Anwendung:</b></p> <p>Das von Ihnen erworbene Behältnismöbel eignet sich für den allgemeinen, privaten Wohnbereich. Es ist nicht für den Nass-, Aussen- oder gewerblichen Bereich geeignet.</p>	<p><b>Usage:</b></p> <p>Le meuble de rangement que vous avez acheté convient pour l'habitat privé en général. Il ne convient pas pour l'extérieur, les milieux humides ou le domaine commercial.</p>	<p><b>Impiego:</b></p> <p>il mobile contenitore acquistato è adatto per un utilizzo in generale, in ambiente domestico. Non è adatto per gli esterni, per l'esposizione alla pioggia o per ambienti commerciali.</p>	<p><b>Area of use:</b></p> <p>The storage furniture you have purchased is suitable for use in general private living quarters. It is not suitable for areas that are wet, outside or used for commercial purposes.</p>
--	---	--	--	--

	<p><b>Max. Belastung:</b></p>	<p><b>Charge max.:</b></p>	<p><b>Carico max.:</b></p>	<p><b>Max. load:</b></p>
--	-------------------------------	----------------------------	----------------------------	--------------------------

	<p><b>ACHTUNG Verschluck- und Erstickungsgefahr:</b> Kleinteile und Verpackungsmaterial können verschluckt werden.</p> <p>Tüten und Folien sind kein Spielzeug! Bitte von Babys und Kleinkindern fernhalten! Nicht über den Kopf ziehen, Erstickungsgefahr!</p>	<p><b>ATTENTION Risque d'ingestion et d'étouffement:</b> Les petites pièces et le matériel d'emballage peuvent être avalés.</p> <p>Les sacs et films ne sont pas des jouets! Veuillez les tenir hors de portée des bébés et jeunes enfants! Ne pas mettre sur la tête, risque d'étouffement!</p>	<p><b>ATTENZIONE Pericolo di ingestione e soffocamento:</b> piccole parti e materiale di imballaggio possono essere ingerite.</p> <p>Sacchetti e pellicole non sono un giocattolo! Tenere lontano dalla portata dei neonati e dei bambini piccoli! Non metterli in testa, pericolo di soffocamento!</p>	<p><b>CAUTION Risk of swallowing and choking:</b> Small parts and packaging material may be swallowed.</p> <p>Bags and film coverings are not toys! Please keep away from babies and small children! Do not put them over your head, risk of suffocation!</p>
--	---	--	---	---



**Warnhinweise**

**Mises en garde**

**Avvertenze**

**Warning notice**



**ACHTUNG,  
Verletzungsgefahr:**  
Kleinkinder dürfen sich nicht im Montage-Bereich aufhalten und an Möbeln hochziehen oder hinaufklettern.

**ATTENTION,  
risque de blessures:**  
Les jeunes enfants ne peuvent pas se tenir dans la zone de montage ni tirer ou grimper sur des meubles.

**ATTENZIONE,  
pericolo di lesioni:**  
tenere i bambini lontano dal luogo di montaggio e evitare che si appendano o arrampichino sul mobile.

**CAUTION,  
risk of injury:**  
Small children must keep away from the assembly area. They must refrain from climbing up on the furniture.













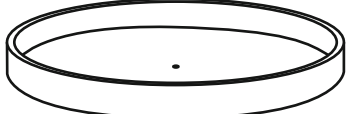

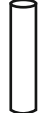
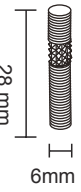
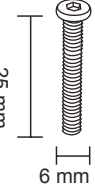

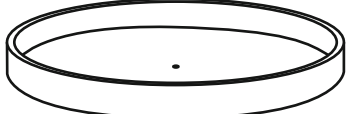
**Altersfreigabe:**  
Nicht für Kinder unter drei Jahren geeignet.

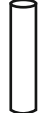
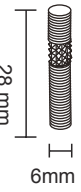
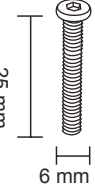
**Age minimum:**  
Ne convient pour les enfants de moins de trois ans.

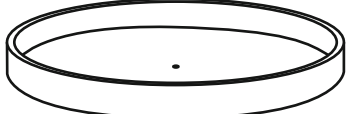
**Limite di età:**  
non adatto per bambini sotto i tre anni.

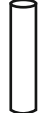
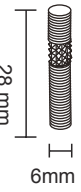
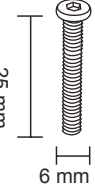
**Age restriction:**  
Not suitable for children under three.

1.	Montagehinweise	Instructions de montage	Istruzioni di montaggio	Assembly information								
	<b>Personen:</b> Für die Montage erforderliche Anzahl Personen.	<b>Personnes:</b> Nombre de personnes nécessaires au montage.	<b>Persone:</b> numero di persone necessarie per il montaggio.	<b>People:</b> Number of people required for the assembly.								
	<b>Montagerichtzeit:</b> Ungefähre Zeit in Stunden.	<b>Durée indicative du montage:</b> Durée approximative en heures.	<b>Tempo di montaggio:</b> tempo in ore approssimativo.	<b>Assembly time:</b> Approximate time in hours.								
<p style="text-align: center;"><b>Benötigtes Werkzeug: Outils nécessaires: Attrezzi necessari: Tools required:</b></p> 												
<table border="0" style="width: 100%; text-align: center;"> <thead> <tr> <th data-bbox="438 925 606 952">Bau-/Kleinteile:</th> <th data-bbox="702 925 885 952">Éléments/pièces:</th> <th data-bbox="965 925 1109 981">Componenti/ piccoli pezzi:</th> <th data-bbox="1236 925 1380 981">Components/ small parts:</th> </tr> </thead> <tbody> <tr> <td data-bbox="215 996 566 1489">   <b>1</b> x1     <b>2</b> x1           </td> <td data-bbox="646 1019 869 1489">   <b>3</b> x3     <b>4</b> x1           </td> <td data-bbox="965 1075 1380 1332">   <b>A</b> x1     <b>B</b> x1     <b>C</b> x1           </td> <td></td> </tr> </tbody> </table>					Bau-/Kleinteile:	Éléments/pièces:	Componenti/ piccoli pezzi:	Components/ small parts:	 <b>1</b> x1   <b>2</b> x1	 <b>3</b> x3   <b>4</b> x1	 <b>A</b> x1   <b>B</b> x1   <b>C</b> x1	
Bau-/Kleinteile:	Éléments/pièces:	Componenti/ piccoli pezzi:	Components/ small parts:									
 <b>1</b> x1   <b>2</b> x1	 <b>3</b> x3   <b>4</b> x1	 <b>A</b> x1   <b>B</b> x1   <b>C</b> x1										

3.

Montage-  
anleitung

Instructions de  
montage

Istruzioni per  
il montaggio

Assembling  
instruction

1

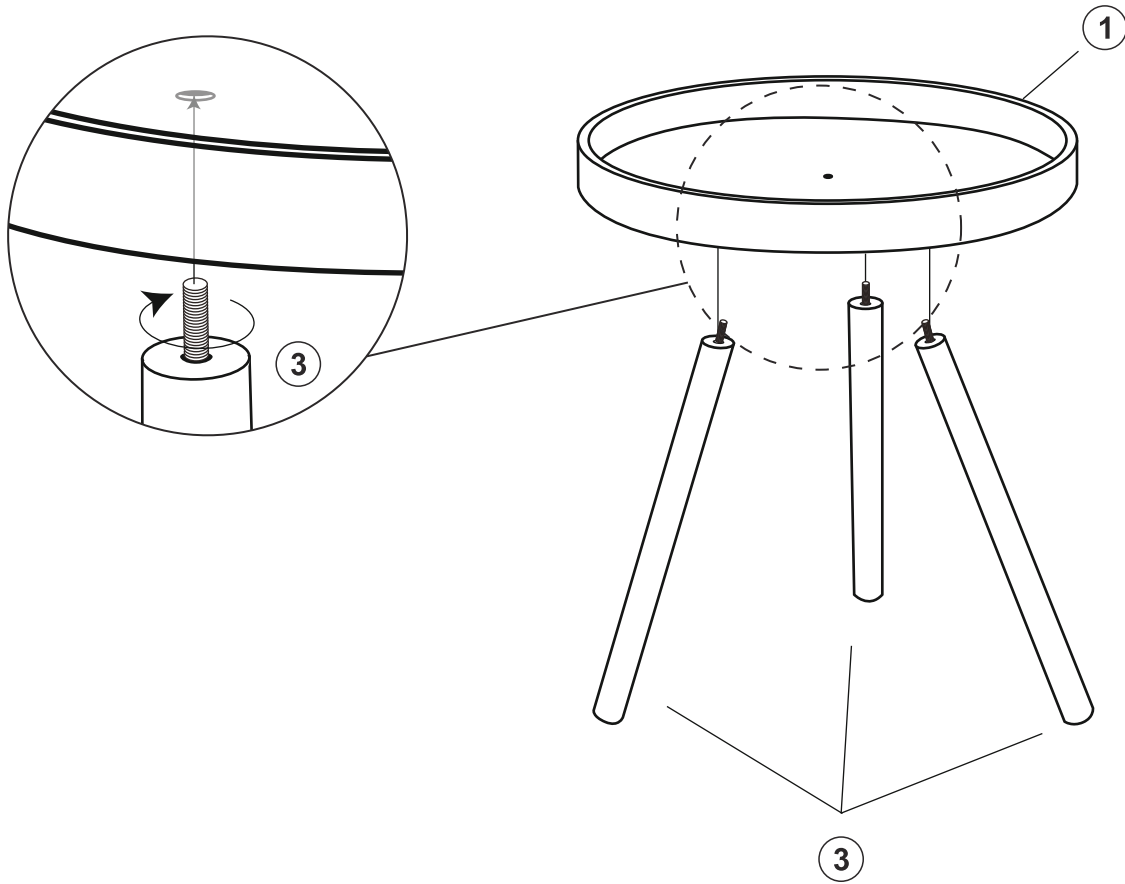

2 2x

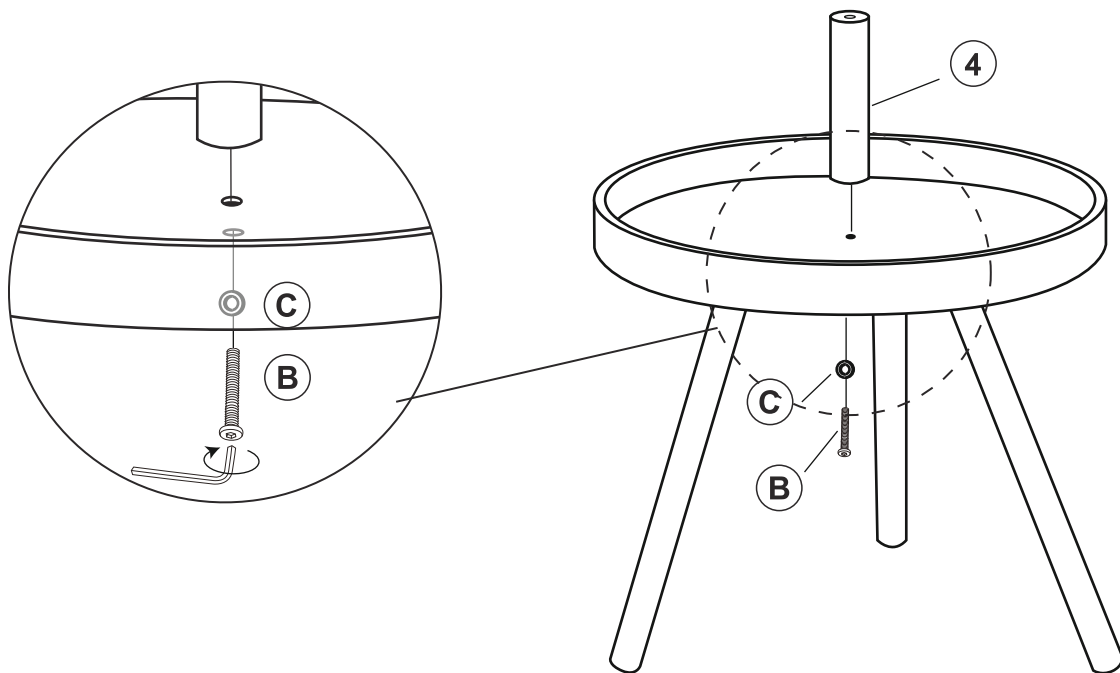

**3** 1x

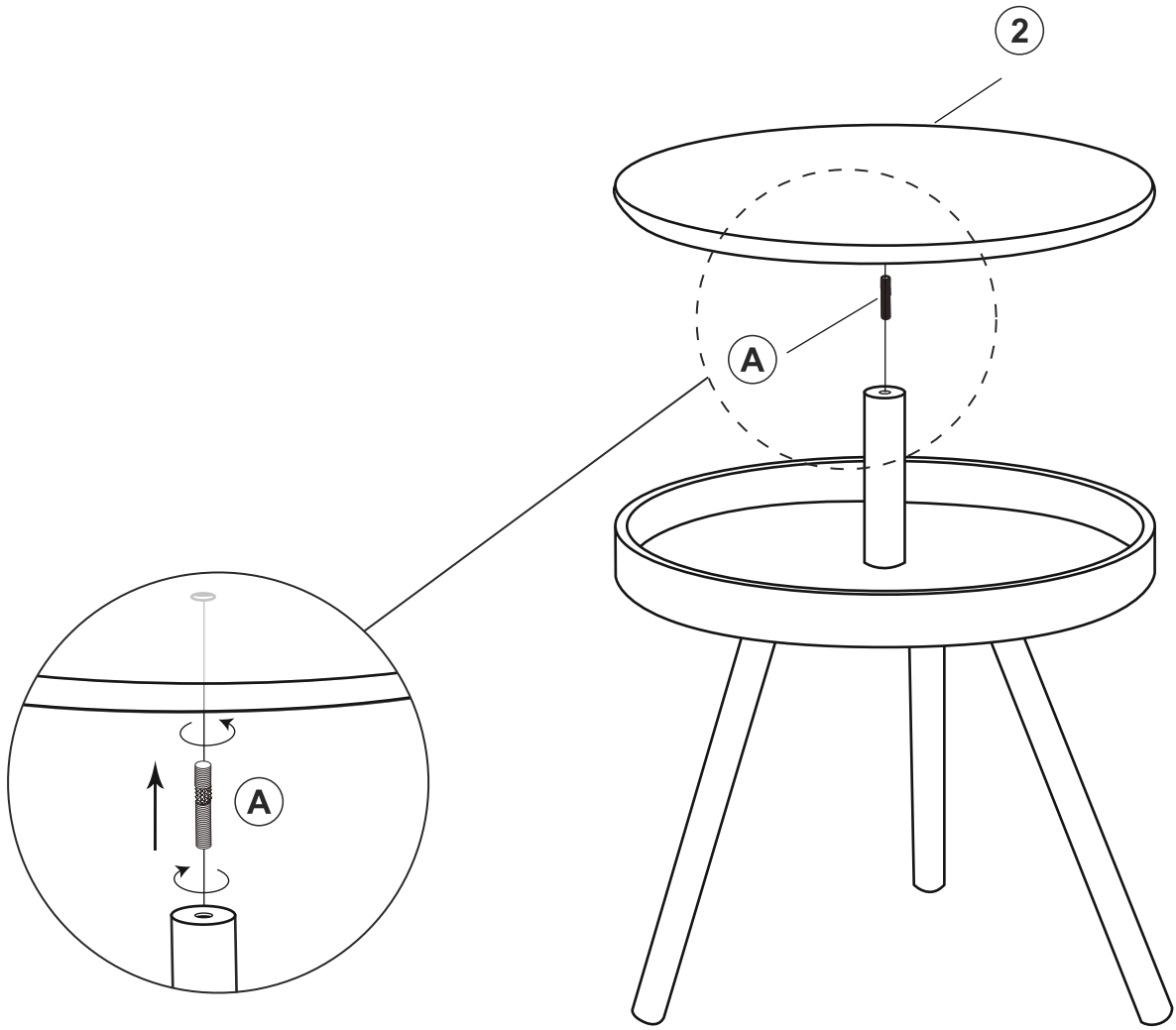

**Reinigung allgemein:**

Flecken immer sofort entfernen. Ein sauberes, weisses Tuch verwenden.



Sauberes Wasser verwenden. Lässt sich der Fleck so nicht entfernen, seifenhaltiges Wasser verwenden. Werden Reinigungsmittel verwendet, diese immer zuerst an einer nicht sichtbaren Stelle testen.



Keine chemischen, scheuernden oder kratzenden Reinigungs-/Hilfsmittel verwenden.

**Nettoyage en général:**

Toujours éliminer immédiatement les taches. Utiliser un chiffon blanc, propre.

Utiliser une eau propre. Si la tache ne s'enlève pas, utiliser une eau savonneuse. Si un produit de nettoyage est utilisé, toujours l'essayer préalablement dans un endroit invisible.

Ne pas utiliser de produits ou moyens chimiques, agressifs ou abrasifs.

**Pulizia generale:**

rimuovere sempre subito le macchie. Utilizzare un panno bianco, pulito.

Utilizzare acqua pulita. Se la macchia non viene via, utilizzare dell'acqua con sapone. Se si utilizzano dei detergenti, provarli sempre prima in un punto non visibile.

Non utilizzare detergenti chimici o prodotti/materiali abrasivi.

**General cleaning instructions:**

Always remove stains immediately. Use a clean, white cloth.

Use clean water. If the stain does not come out, use soapy water. If you use cleaning detergents, always test them first in a concealed spot.

Do not use any chemical or abrasive cleaning detergents or cloths/tools.

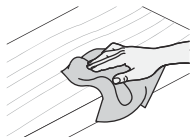
**Möbelpflege:**

Lackiertes Holz nur mit einem leicht feuchten Tuch abwischen.



Geölte Holzoberflächen je nach Gebrauch, von Zeit zu Zeit (z.B. halbjährlich) erneut ölen.



Keine chemischen, scheuernden oder kratzenden Reinigungs-/Hilfsmittel verwenden.

**Entretien des meubles:**

Essuyer le bois vernis uniquement avec un chiffon légèrement humide.

Pour les surfaces en bois huilé, appliquer de temps à autre (p.ex. tous les 6 mois) et en fonction de l'utilisation une huile pour bois.

Ne pas utiliser de produits ou moyens chimiques, agressifs ou abrasifs.

**Cura dei mobili:**

pulire il legno laccato utilizzando soltanto un panno leggermente umido.

Le superfici di legno oliate di tanto in tanto, a seconda del loro utilizzo (ad es. ogni sei mesi), devono essere nuovamente trattate con olio.

Non utilizzare detergenti chimici o prodotti/materiali abrasivi.

**Furniture care:**

Only wipe varnished wood with a slightly damp cloth.

Re-oil oiled wooden surfaces from time to time (e.g. every half a year) depending on use.

Do not use any chemical or abrasive cleaning detergents or cloths/tools.

4.	Wartung	Entretien	Manutenzione	Maintenance
	<b>Schrauben:</b> Für einwandfreie, zuverlässige Funktion, Schrauben regelmäßig nachziehen (z.B. halbjährlich).	<b>Vis:</b> Resserrer régulièrement les vis (p.ex. tous les 6 mois) pour assurer un fonctionnement sûr et correct.	<b>Viti:</b> per garantire un funzionamento corretto e sicuro tirare regolarmente le viti (ad es. ogni sei mesi).	<b>Screws:</b> To keep your furniture in good working order, tighten the screws regularly (e.g. every six months).

5.	Entsorgung	Élimination	Smaltimento	Disposal
	<b>Entsorgungsservice:</b> Micasa bietet Ihnen einen Entsorgungsservice an. Weitere Informationen erhalten Sie unter <a href="http://www.micasa.ch">www.micasa.ch</a>	<b>Service d'élimination:</b> Micasa vous propose un service d'élimination. Vous trouverez des informations supplémentaires sur <a href="http://www.micasa.ch">www.micasa.ch</a>	<b>Servizio di smaltimento:</b> Micasa vi offre un servizio di smaltimento. Ulteriori informazioni sono disponibili su <a href="http://www.micasa.ch">www.micasa.ch</a>	<b>Disposal service:</b> Micasa offers a disposal service. For more information visit <a href="http://www.micasa.ch">www.micasa.ch</a>
	<b>Entsorgung:</b> Nicht mehr verwendete Möbel der fachgerechten Entsorgung übergeben. Wenden Sie sich an Ihre lokale Entsorgungsstelle.	<b>Élimination:</b> Veuillez remettre les meubles qui ne sont plus utilisés à une entreprise d'élimination. Adressez-vous à votre centre de collecte local.	<b>Smaltimento:</b> i mobili dismessi devono essere conferiti presso i centri di raccolta rifiuti per il loro corretto smaltimento. Rivolgersi presso il centro di raccolta locale.	<b>Disposal:</b> To correctly dispose of furniture that is no longer used, contact your local recycling centre.

6.	Kontakt / Service	Contact / service	Contatto / servizio	Contact / service
	<b>Fragen / Anregungen:</b> Wir sind gerne für Sie erreichbar: Montag bis Freitag 08.00 bis 18.00 Uhr Samstag 08.30 bis 16.30 Uhr Tel. 0800 840 848	<b>Questions / suggestions:</b> Nous sommes à votre disposition: Lundi - vendredi 08h00 à 18h00 Samedi 08h30 à 16h30 Tél. 0800 840 848	<b>Domande / suggerimenti:</b> siamo a vostra disposizione: lunedì - venerdì dalle 08.00 alle 18.00 sabato dalle 08.30 alle 16.30 Tel. 0800 840 848	<b>Questions / Suggestions</b> Please contact us. Our opening times are: Monday - Friday 8.00 to 18.00 Saturday 8.30 to 16.30 Phone 0800 840 848

	<b>Ersatzteile:</b> Erhalten Sie direkt im Online-Shop von Migros-Service: <a href="http://www.migros-service.ch">www.migros-service.ch</a>	<b>Pièces de rechange:</b> Vous les obtenez directement dans le magasin en ligne de Migros-Service: <a href="http://www.migros-service.ch">www.migros-service.ch</a>	<b>Pezzi di ricambio:</b> sono disponibili direttamente sull'online-shop di Migros-Service: <a href="http://www.migros-service.ch">www.migros-service.ch</a>	<b>Spare parts:</b> Available directly from the Migros-Service online shop: <a href="http://www.migros-service.ch">www.migros-service.ch</a>
---	---	--	--	--