

Getting started with  
Logitech®  
Rechargeable Speaker S715i

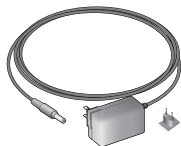

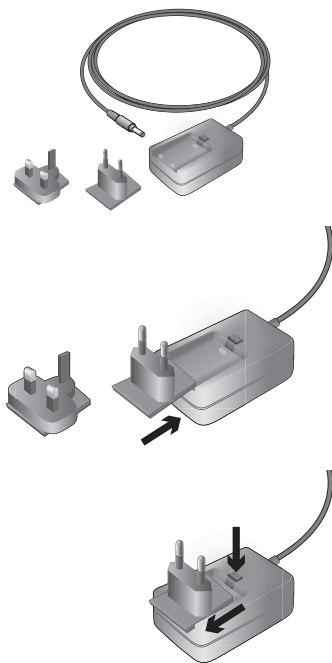

**1**

## Contents

<b>English</b>	5	<b>Suomi</b>	75	<b>Srpski</b>	145
<b>Deutsch</b>	12	<b>Ελληνικά</b>	82	<b>Slovenščina</b>	152
<b>Français</b>	19	<b>По-русски</b>	89	<b>Slovenčina</b>	159
<b>Italiano</b>	26	<b>Magyar</b>	96	<b>Română</b>	166
<b>Español</b>	33	<b>Česká verze</b>	103	<b>Български</b>	173
<b>Português</b>	40	<b>Po polsku</b>	110	<b>Українська</b>	180
<b>Nederlands</b>	47	<b>Eesti</b>	117	<b>Türkçe</b>	187
<b>Svenska</b>	54	<b>Latviski</b>	124	200	<b>العربية</b>
<b>Dansk</b>	61	<b>Lietuvių</b>	131		
<b>Norsk</b>	68	<b>Hrvatski</b>	138		

2

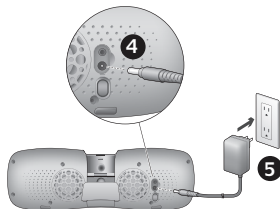
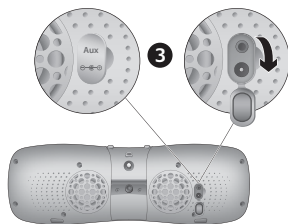
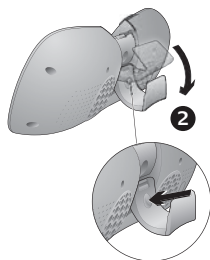
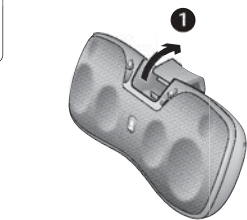

1. Open the dock cover/speaker stand.
2. Push to lock the dock cover/speaker stand into place and put the speaker on a stable surface.
3. Open the cover to the power and auxiliary jacks by pulling down the rubber cover.
4. Insert the power supply cable into the power jack.
5. Plug the power supply into an AC outlet.
6. Pull the battery tab to activate the remote.
7. Charge the speaker. Charging time ranges between 4 to 10 hours depending upon initial battery charge.

3

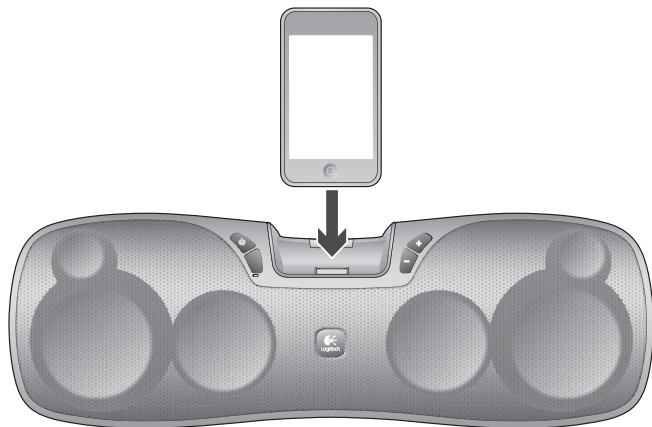

**To listen to music:**

1. Press the Power button  to turn on your S715i speaker.
2. Dock your iPod or iPhone, lean backward for full support.
3. Use the menu of your iPod or iPhone to select a song and press play.
4. Adjust the volume using the **+** **-** buttons located on the speaker.

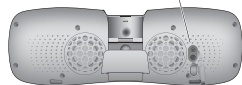
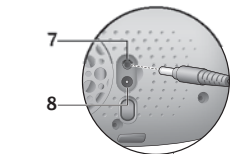
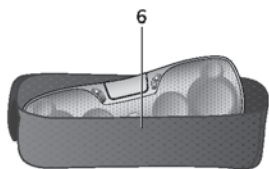
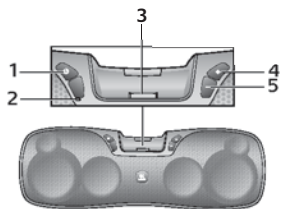

**To use the remote:**

1. Press the Power button  on the remote to turn on/off the speaker.
2. Adjust the volume using the **+** **-** buttons on the remote.
3. Skip forward/backward to the next song (press once) or fast forward/rewind (press and hold)







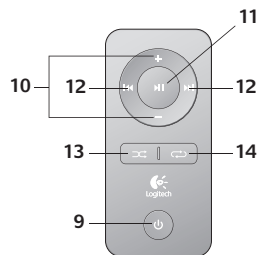

Device and cable not included

### Speaker

1. Powers on/off the S715i 
2. Power LED
3. Universal dock for your Apple device (iPod or iPhone)
4. Increases volume 
5. Decreases volume 
6. S715i carrying case
7. Auxiliary input for other digital music devices with a 3.5mm headphone jack.
8. AC power input jack



### Remote Control

9. Powers on/off the S715i 
10. Increases volume up/ decrease volume 
11. Plays/pauses song 
12. Skips forward/backward through songs, fast forwards/rewinds 
13. Shuffles song/playlist 
14. Repeats song/playlist 

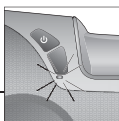

### S715i power LED matrix

Power source	Power LED	Description
AC outlet	No light	S715i is in Standby or Off mode*
	Green, 50% brightness and slow pulsing	S715i is in Standby but still charging
	Green	S715i is powered On, and battery is fully charged
	Green (slow pulsing)	S715i is powered On, and battery is charging
	Green, flashes three times	S715i is entering Off mode or user has put the S715i into Off mode*
Battery	No light	S715i is in Standby or Off mode*
	Green	S715i is On and battery life is greater than 40%
	Orange	S715i is On and battery life is between 5% and 40%
	Red	S715i is On and battery life is less than 5%
	Green, flashes three times	S715i is entering Off mode or user has put the S715i into Off mode*

\*S715i speaker system has two convenient energy saving modes. 1. Standby mode is designed to extend battery life, during normal day to day usage. 2. Off mode is designed for extended periods of non-usage, on AC or battery power.



## Help with Setup

### **My iPod is in the Dock and playing, but I can't hear any music.**

- Make sure the S715i is on. (Power LED should be green.) To turn on the S715i, press the Power button on the remote or the Power button located on the front of the S715i .
- Battery power may be low. Plug in the AC power supply to listen to music while you charge the batteries.
- Try adjusting the volume level using the volume buttons on the remote or those on the speaker.
- Try adjusting the volume level on your iPod or iPhone.
- Try turning off the Sound Check feature on your iPod.
- Download the latest version of iTunes (available at [apple.com](http://apple.com)) and upgrade your iPod to the latest iPod firmware.

### **There isn't a Universal Dock adapter for my iPod.**

- Your S715i speaker does not need any Universal Dock adapters. Its unique design allows full support for your iPod without having to swap out adapters for different iPods.

- If you have a first, second, or third generation iPod, you need to use the Auxiliary input on the back of the S715i. To do so, you will need to purchase a separate cable to connect your iPod to the Auxiliary input. (First and second generation iPod models do not have a dock connector. Third generation iPod models are not supported by the S715i's Universal Dock).

### **The remote isn't working.**

- Point the remote directly at the S715i .
- You need to be within 30 feet of the S715i .
- Make sure the remote sensor isn't being blocked. (It is located above the power LED.)
- The S715i may be in Standby or Sleep Mode. Press the Power button on the remote or the Power button on the front of the S715i to wake up the speaker.
- Try using a fresh battery in the remote.

### **My iPod screen says “OK to disconnect” or “Accessory attached.”**

Depending on your iPod model, these messages will appear when playing iPod playlist presets. Once the music has started playing, the iPod screen will return to normal.

### **For the most up-to-date troubleshooting information, visit:[www.logitech.com](http://www.logitech.com)**

## FAQs

**Q:** How long does it take to recharge the battery of the S715i?

**A:** Anywhere from 4 hours to 10 hours (depending on how far the battery has discharged).  
See the Power LED matrix to determine the current charge of your battery.

**Q:** What is the battery life of the S715i?

**A:** 8 hours of normal operation.\*

**Q:** How can I tell what the battery charge level is on my S715i?

**A:** The multi-color LED on the front of the S715i indicates the battery charge status.  
Refer to the Power LED matrix.

**Q:** Is there a difference in audio quality when the S715i is battery powered?

**A:** Yes. Audio quality (mostly Bass and Loudness) is slightly reduced in order to maximize play time of the S715i.

**Q:** Will the S715i charge my iPod or iPhone?

**A:** Yes, if the S715i is plugged into an AC power outlet. The S715i will not charge the iPod or iPhone if it is running on battery power only.

\* Depending on the volume setting of the S715i

Note: Actual battery life will vary with use, settings, and environmental conditions. Rechargeable batteries have a limited number of charge cycles.

# What do you think?

Please take a minute to tell us.  
Thank you for purchasing our product.\*

The screenshot shows a web-based customer survey form for Logitech. At the top left is the Logitech logo. The title is "Customer Survey". Below the title is the heading "Tell us what you think." followed by the instruction: "Here's your chance. Tell us what you like and what we can improve. Be honest. What you think is directly linked to what we do." The form contains several sections:
 

- "\* Location" with a dropdown menu labeled "Click to Select".
- "\* Product category" with a dropdown menu labeled "Click to Select".
- "\* Product" with a dropdown menu labeled "Select a product family above before proceed".
- "You've owned your product for" with a dropdown menu labeled "Click to Select".
- "\* How likely are you to recommend this product to your friends, colleagues or family?" with a Likert scale from 0 (Not at all likely) to 10 (Extremely likely). The scale uses circular icons with numbers inside. A "Next" button is positioned to the right of the scale.
- "\* Indicates required information" with a red asterisk.

 At the bottom of the form, there are links for "Terms of Use", "Privacy + Security", and "Subscribe", along with the copyright notice "Copyright © 2009 Logitech. All rights reserved." and a page indicator "1 of 2".

[www.logitech.com/jithink](http://www.logitech.com/jithink)

\* The sample *Customer Survey* shown here is in English. Logitech supports many languages on its website.

2

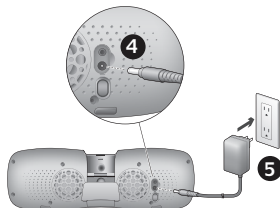
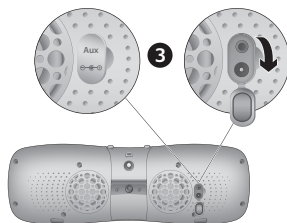
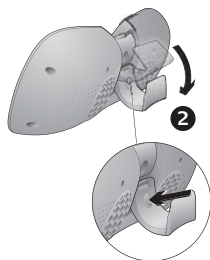



1. Klappen Sie die Dock-Abdeckung/  
den Lautsprecherständer nach unten.
2. Drücken Sie die Dock-Abdeckung/den  
Lautsprecherständer so lange nach unten,  
bis sie/er einrastet, und stellen Sie den  
Lautsprecher auf eine stabile Unterlage.
3. Öffnen Sie die Gummi-Abdeckung für  
die Netzteilbuchse und den AUX-Eingang,  
indem Sie sie nach unten ziehen.
4. Stecken Sie das Stromkabel in die  
Netzteilbuchse.
5. Schließen Sie das Stromkabel an  
eine Steckdose an.
6. Ziehen Sie den Batterie-Schutzstreifen  
heraus, um die Fernbedienung  
zu aktivieren.
7. Laden Sie den Lautsprecher auf.  
Das Aufladen kann zwischen 4 und  
10 Stunden dauern, je nach Ladezustand  
des Akkus.

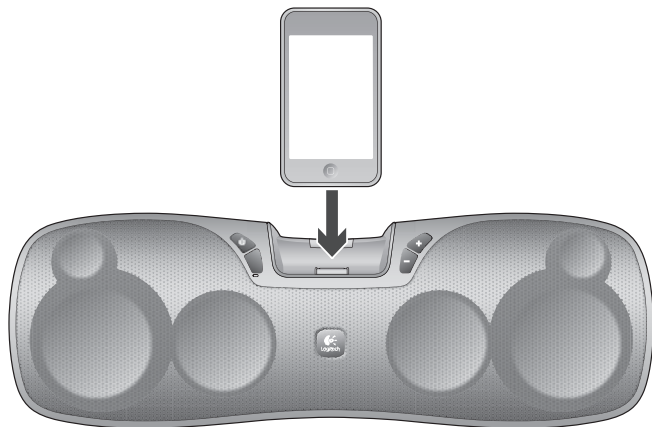

3



#### So spielen Sie Musik ab:

1. Drücken Sie die Ein-/Aus-Taste , um Ihren S715i-Lautsprecher einzuschalten.
2. Schließen Sie Ihren iPod bzw. Ihr iPhone an und lehnen Sie das Gerät für einen optimalen Betrieb schräg nach hinten.
3. Wählen Sie über das Menü Ihres iPod/iPhone einen Titel und drücken Sie die Wiedergabetaste.
4. Regeln Sie die Lautstärke über die Tasten  auf dem Lautsprecher.

#### So verwenden Sie die Fernbedienung:

1. Drücken Sie die Ein-/Aus-Taste  auf der Fernbedienung, um den Lautsprecher ein- bzw. auszuschalten.
2. Regeln Sie die Lautstärke über die Tasten  auf der Fernbedienung.
3. Springen Sie zum nächsten/vorherigen Titel (kurz drücken) oder spulen Sie vor/zurück (gedrückt halten).

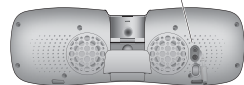
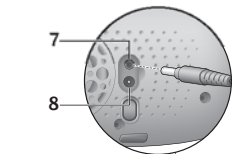
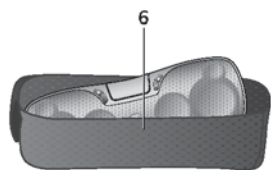
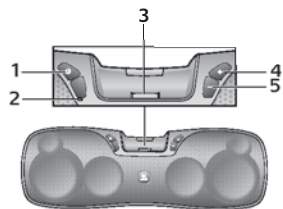





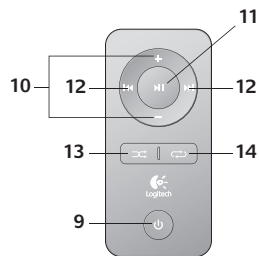

Gerät und Kabel nicht im Lieferumfang enthalten

### Lautsprecher

1. Schaltet den S715i ein bzw. aus 
2. Betriebs-LED
3. Universal Dock für Apple-Geräte (iPod oder iPhone)
4. Erhöht die Lautstärke 
5. Verringert die Lautstärke 
6. Reise-Etui für den S715i
7. AUX-Eingang für andere digitale Audiogeräte mit 3,5-mm-Kopfhörerbuchse
8. Netzteilbuchse



### Fernbedienung

9. Schaltet den S715i ein bzw. aus 
10. Erhöht/verringert die Lautstärke 
11. Wiedergabe/Pause 
12. Springt zum nächsten/ vorherigen Titel, spult vor/ zurück 
13. Spielt Titel/Wiedergabeliste in zufälliger Reihenfolge 
14. Wiederholt Titel/ Wiedergabeliste 

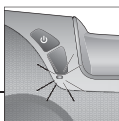

### Betriebs-LED-Matrix des S715i

<b>Stromquelle</b>	<b>Betriebs-LED</b>	<b>Beschreibung</b>
Steckdose	LED leuchtet nicht	S715i befindet sich im Standby- oder Aus-Modus*
	Grün, 50% Helligkeit und langsames Blinken	S715i ist im Standby-Modus, Akku wird aber trotzdem geladen
	Grün	S715i ist eingeschaltet, Akku ist vollständig aufgeladen
	Grün (langsames Blinken)	S715i ist eingeschaltet, Akku wird gerade geladen
	Grün, dreimaliges Blinken	S715i schaltet gerade in den Aus-Modus oder der Benutzer hat den Aus-Modus aktiviert*
Akku	LED leuchtet nicht	S715i befindet sich im Standby- oder Aus-Modus*
	Grün	S715i ist eingeschaltet, Ladezustand des Akkus beträgt mehr als 40%
	Orange	S715i ist eingeschaltet, Ladezustand des Akkus liegt zwischen 5 und 40%
	Rot	S715i ist eingeschaltet, Ladezustand des Akkus beträgt weniger als 5%
	Grün, dreimaliges Blinken	S715i schaltet gerade in den Aus-Modus oder der Benutzer hat den Aus-Modus aktiviert*

\* Das Lautsprechersystem S715i verfügt über zwei Energiesparmodi. 1. Der Standby-Modus ist dafür gedacht, die Akkulaufzeit im täglichen Gebrauch zu verlängern. 2. Der Aus-Modus ist empfehlenswert, wenn das Gerät über einen längeren Zeitraum nicht verwendet wird und über Netz- oder Akkubetrieb läuft.

## Probleme bei der Einrichtung?

### Mein iPod ist im Dock und die Wiedergabe läuft, aber ich höre keine Musik.

- Vergewissern Sie sich, dass der S715i eingeschaltet ist. (Die Betriebs-LED sollte grün leuchten.) Um den S715i einzuschalten, drücken Sie die Ein-/Aus-Taste auf der Fernbedienung oder auf der Vorderseite des Lautsprechers.
- Möglicherweise ist der Akkustand niedrig. Schließen Sie das Netzteil an die Stromversorgung an, um während des Aufladens der Akkus Musik hören zu können.
- Regeln Sie die Lautstärke mit den entsprechenden Tasten auf der Fernbedienung oder dem Lautsprecher.
- Regeln Sie die Lautstärke auf Ihrem iPod bzw. iPhone.
- Deaktivieren Sie die Funktion „Lautstärke anpassen“ auf dem iPod.
- Laden Sie die aktuelle Version von iTunes herunter (erhältlich auf [apple.com](http://apple.com)) und aktualisieren Sie Ihren iPod mit der neuesten iPod-Firmware.

### Für meinen iPod gibt es keinen Universal Dock-Adapter.

- Ihr S715i-Lautsprecher benötigt keinen Universal Dock-Adapter. Der Lautsprecher ist so konstruiert, dass Sie verschiedene iPod-Modelle verwenden können, ohne dafür Adapter austauschen zu müssen.

- Wenn Sie einen iPod der 1., 2. oder 3. Generation haben, schließen Sie ihn über den AUX-Eingang auf der Rückseite des S715i an. Hierfür benötigen Sie ein zusätzliches Kabel (nicht im Lieferumfang enthalten). (iPod-Modelle der 1. und 2. Generation verfügen über keinen Dockanschluss. iPods der 3. Generation werden nicht vom Universal Dock des S715i unterstützt.)

### Die Fernbedienung funktioniert nicht.

- Zeigen Sie mit der Fernbedienung direkt auf den Lautsprecher.
- Die Fernbedienung des S715i funktioniert innerhalb einer Reichweite von 9 Metern.
- Vergewissern Sie sich, dass der Fernbedienungssensor nicht blockiert ist. (Er ist über der Betriebs-LED angebracht.)
- Möglicherweise ist der S715i im Standby- oder Energiesparmodus. Drücken Sie die Ein-/Aus-Taste auf der Fernbedienung oder auf der Vorderseite des Lautsprechers, um den S715i wieder zu aktivieren.
- Legen Sie neue Batterien in die Fernbedienung ein.

### Mein iPod zeigt an, dass ein Gerät angeschlossen ist oder die Verbindung getrennt werden kann.

Abhängig vom iPod-Modell werden diese Meldungen beim Abspielen von voreingestellten iPod-Wiedergabelisten angezeigt. Sobald die Wiedergabe begonnen hat, wird die Meldung ausgeblendet.

**Die aktuellsten Informationen zur Fehlerbehebung finden Sie auf [www.logitech.com](http://www.logitech.com).**



## Häufig gestellte Fragen

- F:** Wie lange dauert es, den Akku des S715i aufzuladen?
- A:** Zwischen 4 und 10 Stunden (je nach Ladezustand der Akkus). Die Betriebs-LED-Matrix hilft Ihnen dabei, den Ladezustand des Akkus zu bestimmen.
- F:** Wie lange hält der Akku des S715i?
- A:** 8 Stunden im normalen Betrieb.\*
- F:** Wie kann ich den Ladezustand des S715i-Akkus bestimmen?
- A:** Die mehrfarbige LED auf der Vorderseite des S715i zeigt den Ladezustand des Akkus an. Weitere Informationen finden Sie in der Betriebs-LED-Matrix.
- F:** Unterscheidet sich beim S715i die Audioqualität im Akkubetrieb von der im Netzbetrieb?
- A:** Ja. Die Audioqualität (vor allem Bass und Lautstärke) ist im Akkubetrieb leicht reduziert, um eine möglichst lange Spielzeit zu garantieren.
- F:** Wird mein iPod bzw. iPhone über den S715i aufgeladen?
- A:** Ja, wenn der Lautsprecher an eine Steckdose angeschlossen ist. Läuft der S715i im Akkubetrieb, wird Ihr iPod bzw. iPhone nicht aufgeladen.

\* Abhängig von der Lautstärkeeinstellung des S715i

Hinweis: Die tatsächliche Akkulebensdauer variiert je nach Nutzung des Geräts, Einstellungen und Umgebungsbedingungen. Akkus haben eine begrenzte Lebensdauer.

## Ihre Meinung ist gefragt.

Bitte nehmen Sie sich etwas Zeit, um ein paar Fragen zu beantworten.  
Vielen Dank, dass Sie sich für unser Produkt entschieden haben.\*

The image shows a screenshot of a web-based customer survey form for Logitech. The form is titled "Customer Survey" and includes the Logitech logo. The main heading is "Tell us what you think." Below this, there is a short introductory paragraph. The form contains several sections: "Location" with a dropdown menu, "Product category" with a dropdown menu, "Product" with a dropdown menu, and "You've owned your product for" with a dropdown menu. A question asks "How likely are you to recommend this product to your friends, colleagues or family?" with a scale from 0 (Not at all likely) to 10 (Extremely likely). There is a "Next" button at the end of the scale. At the bottom, there are links for "Terms of Use", "Privacy", "Security", and "Subscribe", along with a copyright notice for 2009 Logitech.

Logitech

### Customer Survey

**Tell us what you think.**

Here's your chance. Tell us what you like and what we can improve. Be honest. What you think is directly linked to what we do.

\* Location  
[Click to Select]

\* Product category  
[Click to Select]

\* Product  
[Select a product family above before proceed]

You've owned your product for  
[Click to Select]

\* How likely are you to recommend this product to your friends, colleagues or family?

Not at all likely   0   1   2   3   4   5   6   7   8   9   10   Extremely likely

\* Indicates required information   [Next]

1 of 2

Terms of Use   Privacy   Security   Subscribe   Copyright © 2009 Logitech. All rights reserved.

[www.logitech.com/ithink](http://www.logitech.com/ithink)

\* Das hier abgebildete Muster der Kundenumfrage ist auf Englisch. Auf der Website von Logitech finden Sie zahlreiche weitere Sprachversionen.

2

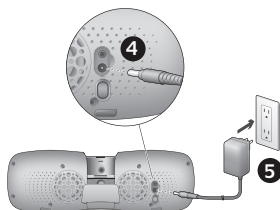
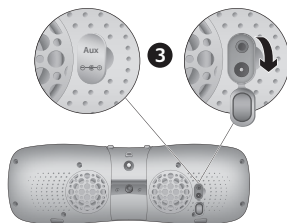
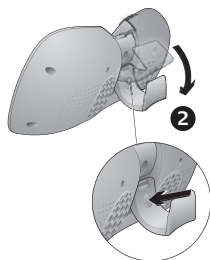

1. Ouvrez le couvercle du dock/support du système.
2. Effectuez une pression pour verrouiller le couvercle du dock/support du système et placez les haut-parleurs sur une surface stable.
3. Accédez aux prises auxiliaire et d'alimentation en soulevant l'opercule en caoutchouc.
4. Insérez le câble du boîtier d'alimentation dans la prise d'alimentation.
5. Branchez le boîtier d'alimentation dans une prise électrique.
6. Retirez la languette de protection des piles pour activer la télécommande.
7. Chargez le système de haut-parleurs. Le temps de charge peut varier de 4 à 10 heures selon le niveau de charge initial de la batterie.

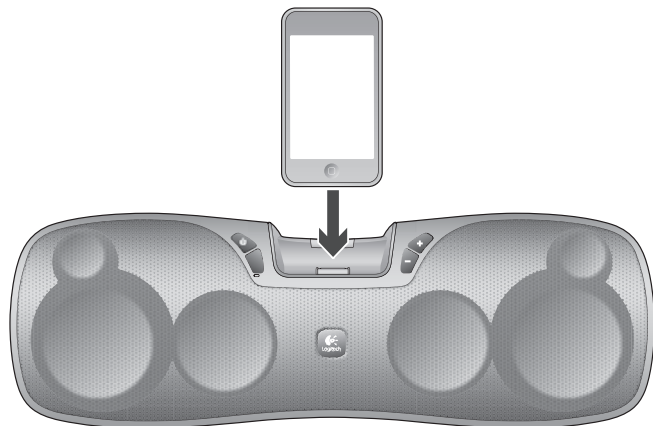

3



#### Pour écouter de la musique:

1. Appuyez sur le bouton de marche/arrêt  pour mettre le système de haut-parleurs S715i sous tension.
2. Placez votre iPod ou votre iPhone dans le dock et inclinez le système vers l'arrière pour qu'il repose sur son support.
3. Utilisez le menu de l'iPod ou de l'iPhone pour sélectionner une chanson et appuyez sur le bouton de lecture.
4. Réglez le volume à l'aide des boutons  situés sur le système de haut-parleurs.

#### Pour utiliser la télécommande :

1. Appuyez sur le bouton de marche/arrêt  de la télécommande pour mettre le système sous ou hors tension.
2. Réglez le volume à l'aide des boutons  situés sur la télécommande.
3. Passez à la chanson précédente/suivante en appuyant une seule fois ou lancez l'avance rapide/le retour rapide en maintenant le bouton enfoncé.

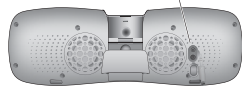
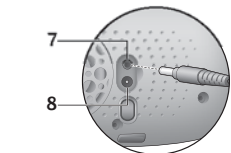
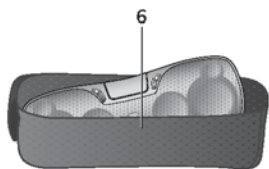
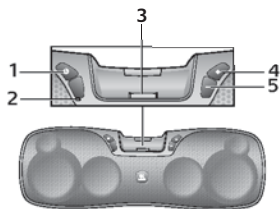

Dispositif et câble non inclus

### Haut-parleurs

1. Mise sous tension/hors tension du système S715i
2. Témoin d'alimentation
3. Dock universel pour votre dispositif Apple (iPod ou iPhone)
4. Augmentation du volume **+**
5. Réduction du volume **-**
6. Etui de transport du système S715i
7. Entrée auxiliaire pour dispositifs de musique numériques dotés d'une prise casque de 3,5 mm.
8. Prise d'entrée pour adaptateur secteur

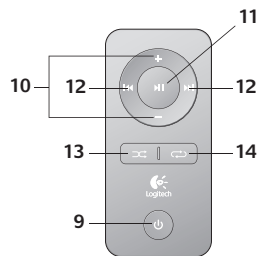

### Télécommande

9. Mise sous tension/hors tension du système S715i
10. Augmentation/réduction du volume **+** **-**
11. Lecture/pause des chansons
12. Passage à la chanson précédente/suivante, avance/retour rapide
13. Activation de la lecture aléatoire (chanson/liste de lecture)
14. Activation de la répétition (chanson/liste de lecture)

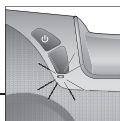
**Tableau descriptif de l'état du témoin d'alimentation S715i**

Source d'alimentation	Témoin d'alimentation	Description
Prise secteur	Témoin éteint	Système S715i en mode de veille ou désactivé*
	Vert, luminosité à 50% et clignotement lent	Système S715i en mode de veille mais en cours de charge
	Vert	Système S715i sous tension et batterie chargée au maximum
	Vert (clignotement lent)	Système S715i sous tension et batterie en cours de charge
	Vert, clignote trois fois	Système S715i passe en mode désactivé ou l'utilisateur l'a mis hors tension*
Batterie	Témoin éteint	Système S715i en mode de veille ou désactivé*
	Vert	Système S715i sous tension avec niveau de charge supérieur à 40%
	Orange	Système S715i sous tension avec niveau de charge de 5 à 40%
	Rouge	Système S715i sous tension avec niveau de charge inférieur à 5%
	Vert, clignote trois fois	Système S715i passe en mode désactivé ou l'utilisateur l'a mis hors tension*

\*Le système de haut-parleurs S715i possède deux modes d'économie d'énergie pratiques. 1. Le mode de veille est conçu pour optimiser la durée de vie de la batterie pour une utilisation quotidienne normale. 2. Le mode désactivé est conçu pour les périodes de non-utilisation prolongées sur le secteur ou la batterie.

## Aide à la configuration

### Mon iPod est sur le dock en mode de lecture mais il n'émet aucun son.

- Assurez-vous que le système S715i est sous tension. Le témoin d'alimentation doit être allumé en vert. Pour mettre le système S715i sous tension, appuyez sur le bouton de marche/arrêt de la télécommande ou sur celui du système S715i (panneau avant).
- Il est possible que le niveau de charge de la batterie soit faible. Branchez le boîtier d'alimentation pour écouter de la musique pendant que vous chargez la batterie.
- Essayez d'ajuster le niveau du volume en utilisant les boutons de volume de la télécommande ou du système de haut-parleurs.
- Essayez de régler le volume sur votre iPod ou votre iPhone.
- Essayez de désactiver la fonction Essai sonore sur votre iPod.
- Téléchargez la dernière version d'iTunes (disponible à l'adresse [apple.com](http://apple.com)) et mettez votre iPod à niveau à l'aide du dernier micrologiciel iPod.

### Il n'existe aucun adaptateur de dock universel pour mon lecteur iPod.

- Votre système S715i ne nécessite pas d'adaptateur de dock universel. Sa conception unique permet une prise en charge intégrale de votre iPod sans changement d'adaptateur pour les différents modèles d'iPod.

- Si vous possédez un iPod de première, deuxième ou troisième génération, vous devez utiliser l'entrée auxiliaire au dos du système S715i. Le câble de connexion de l'iPod à l'entrée auxiliaire est vendu séparément. Les lecteurs iPod de première et de deuxième générations ne disposent pas de connecteur dock. Les lecteurs iPod de troisième génération ne sont pas pris en charge par le dock universel du système S715i.

### La télécommande ne fonctionne pas.

- Pointez la télécommande directement vers le système S715i.
- Vous devez vous trouver à moins d'un mètre du système.
- Assurez-vous que le capteur est bien dégagé (il est situé au-dessus du témoin d'alimentation).
- Le système S715i peut être en mode de veille. Appuyez sur le bouton de marche/arrêt de la télécommande ou du système S715i (panneau avant) pour réactiver les haut-parleurs.
- Utilisez des piles neuves avec la télécommande.

### L'écran de mon iPod affiche le message "OK pour la déconnexion" ou "Accessoire connecté".

Selon le modèle de votre iPod, ces messages s'affichent lorsque vous écoutez des préréglages musicaux de l'iPod. Une fois que la musique a démarré, l'écran de l'iPod redevient normal.

**Pour obtenir des informations à jour relatives au dépannage, visitez le site Web Logitech à l'adresse [www.logitech.com](http://www.logitech.com).**

## Questions fréquentes

**Q:** Combien de temps faut-il pour recharger la batterie du système S715i?

**R:** Le temps de charge varie de 4 à 10 heures selon le niveau de la batterie. Reportez-vous au tableau indicateur de l'état du témoin d'alimentation pour déterminer le niveau de charge actuel de la batterie.

**Q:** Quelle est la longévité de la batterie du système S715i?

**R:** 8 heures d'utilisation normale.\*

**Q:** Comment connaître le niveau de charge du système S715i?

**R:** Le témoin multicolore situé sur le devant du système indique le niveau de charge de la batterie. Reportez-vous à au tableau descriptif de l'état du témoin d'alimentation.

**Q:** La qualité audio diffère-t-elle selon que le système fonctionne sur la batterie ou sur secteur?

**R:** Oui. La qualité audio (volume et graves en particulier) est légèrement affectée lorsque le système fonctionne sur la batterie afin d'optimiser le temps de charge du système S715i.

**R:** Le système S715i permet-il de charger mon iPod ou mon iPhone?

**R:** Oui, si les haut-parleurs sont branchés sur le secteur. Il ne permet pas de recharger votre iPod ou iPhone s'il fonctionne sur la batterie uniquement.

\*Varie selon le réglage du volume de l'ensemble S715i.

Remarque: la durée de vie de la batterie est susceptible de varier en fonction de l'environnement, des paramètres et du mode d'utilisation. Les batteries rechargeables ne peuvent être rechargées qu'un nombre limité de fois.



## Qu'en pensez-vous?

Prenez quelques minutes pour nous faire part de vos commentaires.  
Vous venez d'acheter ce produit et nous vous en félicitons.\*

**Logitech** Customer Survey

**Tell us what you think.**

Here's your chance. Tell us what you like and what we can improve. Be honest. What you think is directly linked to what we do.

\* Location

\* Product category

\* Product

You've owned your product for

\* How likely are you to recommend this product to your friends, colleagues or family?

Not at all likely  0  1  2  3  4  5  6  7  8  9  10 Extremly likely

\* Indicates required information

1 of 2

[Terms of Use](#) [Privacy + Security](#) [Subscribe](#) Copyright © 2009 Logitech. All rights reserved.

[www.logitech.com/ithink](http://www.logitech.com/ithink)

\* L'exemple d'enquête clientèle présenté ici est en anglais. Logitech dispose d'un site Web en plusieurs langues.

2

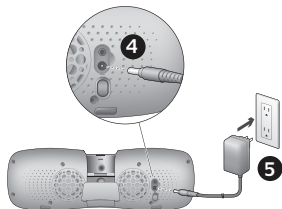
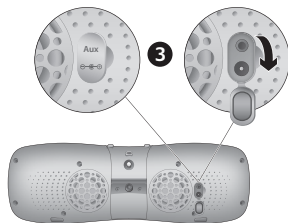
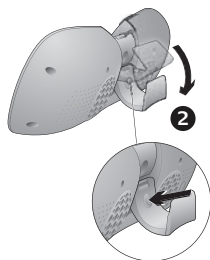



1. Aprire il coperchio del dock/supporto dell'altoparlante.
2. Premere per bloccare in posizione il coperchio del dock/supporto dell'altoparlante e posizionare l'altoparlante su una superficie stabile.
3. Aprire il coperchio del vano contenente le spine di alimentazione e ausiliaria tirando verso il basso la parte in gomma.
4. Inserire il cavo dell'alimentatore nella presa di alimentazione.
5. Collegare l'alimentatore a una presa di corrente.
6. Tirare la linguetta della batteria per attivare il telecomando.
7. Caricare l'altoparlante. Il tempo di caricamento è compreso tra le 4 e le 10 ore a seconda della carica iniziale della batteria.

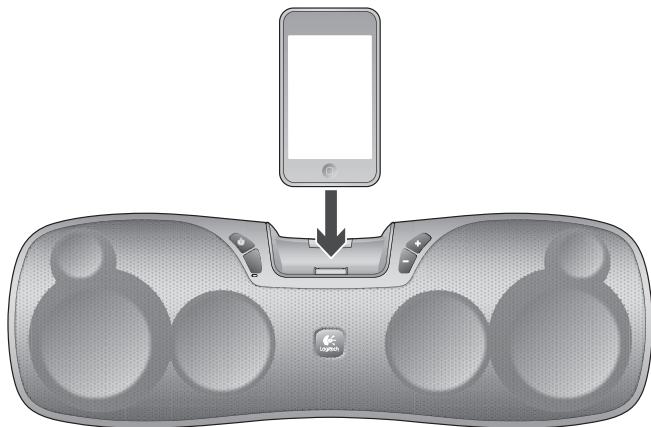

3



#### Per ascoltare la musica:

1. Premere il pulsante di alimentazione  per accendere l'altoparlante S715i.
2. Appoggiare l'iPod o l'iPhone adagiandolo all'indietro per maggiore stabilità.
3. Utilizzare il menu dell'iPod o dell'iPhone per selezionare un brano e premere il pulsante di riproduzione.
4. Regolare il volume utilizzando i pulsanti  dell'altoparlante.

#### Per utilizzare il telecomando:

1. Premere il pulsante di accensione  sul telecomando per accendere/spegnere l'altoparlante.
2. Regolare il volume utilizzando i pulsanti  del telecomando.
3. Passare al brano successivo o al precedente (premere una volta) o avanzare/riavvolgere rapidamente il brano (tenere premuto)

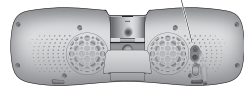
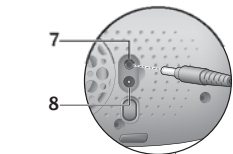
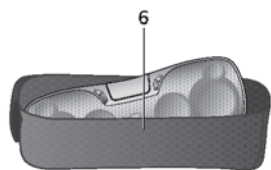
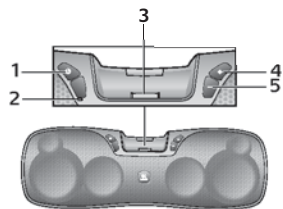



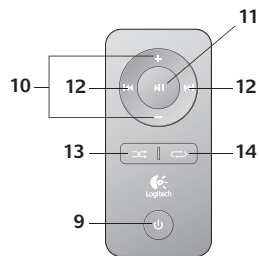



Dispositivo e cavo non inclusi



### Altoparlante

1. Accende o spegne il S715i 
2. LED alimentazione
3. Dock universale per il dispositivo Apple (iPod o iPhone)
4. Aumenta il volume 
5. Diminuisce il volume 
6. Custodia da viaggio dispositivo S715i
7. Ingresso ausiliario per altri dispositivi per musica digitali con connettore per cuffie da 3,5 mm.
8. Connettore ingresso alimentazione CA

### Telecomando

9. Accende o spegne l'altoparlante S715i 
10. Aumenta/diminuisce il volume 
11. Riproduce/mette in pausa il brano 
12. Passa al brano successivo o precedente, avanza o riavvolge rapidamente il brano 
13. Esegue la riproduzione casuale di brani / elenchi di riproduzione 
14. Ripete brani / elenchi di riproduzione 

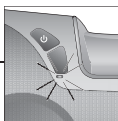

### Tabella dello stato del LED di alimentazione dell'altoparlante S715i

Alimentazione	LED alimentazione	Descrizione
Presenza CA	Spento	L'altoparlante S715i è in modalità Standby o Disattivata*
	Verde, luminosità 50%, lampeggiamento lento	L'altoparlante S715i è in Standby, ma è ancora in carica
	Verde	L'altoparlante S715i è alimentato e la batteria è completamente carica
	Verde (lampeggiante)	L'altoparlante S715i è alimentato e la batteria è in carica
	Verde, lampeggia tre volte	S715i sta attivando la modalità Off o l'utente ha attivato la modalità Off.*
Batteria	Spento	L'altoparlante S715i è in modalità Standby o Disattivata*
	Verde	L'altoparlante S715i è acceso e il livello di carica della batteria è superiore al 40%
	Arancione	L'altoparlante S715i è acceso e il livello di carica della batteria è compreso tra il 5% e il 40%
	Rosso	L'altoparlante S715i è acceso e il livello di carica della batteria è inferiore al 5%
	Verde, lampeggia tre volte	S715i sta attivando la modalità Off o l'utente ha attivato la modalità Off.*

\*Il sistema di altoparlanti S715i è dotato di due pratiche modalità di risparmio energetico. 1. La modalità di Standby è progettata per prolungare la durata della batteria nel normale utilizzo quotidiano. 2. La modalità Disattivata è progettata per periodi prolungati di inutilizzo con alimentazione CA o di batteria.

## Problemi di installazione

### **L'iPod è inserito nel dock ed è in corso la riproduzione, ma non si sente alcun suono.**

- Accertarsi che l'altoparlante S715i sia acceso. (Il LED di alimentazione dovrebbe essere di colore verde). Per accendere l'altoparlante S715i, premere il pulsante di alimentazione del telecomando o il pulsante di alimentazione posto sulla parte anteriore dell'altoparlante S715i.
- La carica della batteria potrebbe essere insufficiente. Collegare l'alimentatore C.A. per ascoltare musica durante la ricarica delle batterie.
- Provare a regolare il volume utilizzando i pulsanti del telecomando o quelli dell'altoparlante.
- Provare a regolare il volume dell'iPod o dell'iPhone.
- Provare a disattivare la funzione di verifica del suono dell'iPod.
- Scaricare la versione più recente di iTunes (disponibile all'indirizzo [www.apple.com](http://www.apple.com)) e aggiornare il firmware dell'iPod alla versione più recente.

### **Non è incluso un adattatore universale per dock per il mio iPod.**

- Se si ha un iPod di prima, seconda o terza generazione, è necessario utilizzare l'ingresso ausiliario sul retro dell'S715i. Per farlo, è necessario acquistare un cavo separato che consenta la connessione dell'iPod all'ingresso ausiliario. Gli iPod di prima e di seconda generazione non sono dotati di connettore per dock, mentre gli iPod di terza generazione non sono supportati dal dock universale dell'S715i.

- L'altoparlante S715i non necessita di adattatori universali per dock. Il design esclusivo consente il controllo totale dell'iPod senza dover scambiare gli adattatori per i diversi iPod.

### **Il telecomando non funziona.**

- Puntare il telecomando direttamente verso l'altoparlante S715i.
- È necessario trovarsi entro una distanza di circa 9 metri dall'altoparlante S715i.
- Assicurarsi che il sensore del telecomando non incontri ostacoli. Il sensore si trova sopra il LED di alimentazione.
- L'altoparlante S715i potrebbe essere impostato in modalità Standby. Per riattivare l'altoparlante, premere il pulsante di alimentazione del telecomando o il pulsante di alimentazione posto sulla parte anteriore dell'altoparlante S715i.
- Provare a sostituire le batterie del telecomando.

### **Sullo schermo dell'iPod viene visualizzato un messaggio in cui si informa che è consentito disconnettersi o che è collegato un accessorio.**

A seconda del modello di iPod utilizzato, questi messaggi vengono visualizzati quando si riproducono le preimpostazioni dell'iPod. Quando inizia la riproduzione della musica, lo schermo dell'iPod ritorna allo stato normale.

### **Per informazioni più aggiornate sulla risoluzione dei problemi, visitare il sito Web [www.logitech.com](http://www.logitech.com).**

## Domande frequenti

- D:** Quanto tempo è necessario per ricaricare la batteria dell'altoparlante S715i?
- R:** Un tempo compreso tra 4 e 10 ore, a seconda del livello iniziale di carica della batteria. Vedere la tabella degli stati del LED di alimentazione per stabilire il livello iniziale di carica della batteria.
- D:** Qual è la durata delle batterie dell'altoparlante S715i?
- A:** 8 ore in condizioni di funzionamento normale\*.
- D:** Come faccio a stabilire il livello di carica delle batterie dell'altoparlante S715i?
- R:** Il LED multicolore situato sulla parte anteriore dell'altoparlante S715i indica lo stato di carica della batteria. Vedere la Tabella dello stato del LED di alimentazione.
- D:** L'alimentazione a batterie dell'altoparlante S715i corrisponde a una differenza di qualità dell'audio?
- R:** Sì, la qualità dell'audio (soprattutto bassi e intensità del suono) è leggermente ridotta per ottenere il massimo tempo di riproduzione dell'altoparlante S715i.
- D:** Un iPod o un iPhone si ricarica quando viene collegato all'altoparlante S715i?
- R:** Sì, se l'altoparlante S715i è collegato a una presa di alimentazione CA. L'altoparlante S715i non ricarica l'iPod o l'iPhone se è alimentato a batteria.

\* Durata variabile a seconda del livello del volume di S715i

Nota: la durata della batteria varia a seconda dell'uso, delle impostazioni e delle condizioni ambientali. Le batterie ricaricabili possono essere sottoposte a un numero limitato di cicli di ricarica.

## Che cosa ne pensi?

Inviaci i tuoi commenti.  
Grazie per avere acquistato questo prodotto\*.

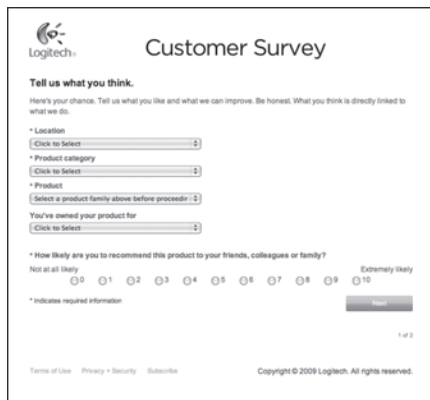

The image shows a screenshot of a web-based customer survey form for Logitech. The form is titled "Customer Survey" and includes the Logitech logo. The main heading is "Tell us what you think." Below this, there is a short instruction: "Here's your chance. Tell us what you like and what we can improve. Be honest. What you think is directly linked to what we do." The form contains several sections with dropdown menus: "Location", "Product category", "Product", and "You've owned your product for". The "Product" section has a sub-instruction: "Select a product family above before proceed". The next question is "How likely are you to recommend this product to your friends, colleagues or family?" with a Likert scale from 0 to 10, where 0 is "Not at all likely" and 10 is "Extremely likely". A "Next" button is located to the right of the scale. At the bottom of the form, there is a "Terms of Use" link, a "Privacy + Security" link, a "Subscribe" link, and a copyright notice: "Copyright © 2009 Logitech. All rights reserved." The page number "1 of 2" is also visible.

[www.logitech.com/ithink](http://www.logitech.com/ithink)

\* Il sondaggio sulla soddisfazione dei clienti di esempio sopra riportato è in inglese. Per la disponibilità in altre lingue, visitare il sito Web Logitech.