

FR Guide de l'utilisateur
EN User's guide
DE Bedienungsanleitung
NL Gebruiksaanwijzing
ES Guía del usuario
PT Guia de utilização
IT Manuale d'uso
TR Kullanım kılavuzu
CS Návod k použití
SK Používateľská príručka
HU Használati útmutató
PL Instrukcja obsługi
ET Kasutusjuhend
LT Naudotojo vadovas
LV Lietošanas pamācība

BG Ръководство на потребителя
RO Ghidul utilizatorului
SL Navodila za uporabnika
HR Upute za uporabu
BS Upute za upotrebu
SR Uputstvo za upotrebu
RU Руководство пользователя
UK Посібник користувача
CN 用户指南
HK 用戶指南
KO 사용자 가이드
AR دليل الإستعمال
FA راهنمای کاربر

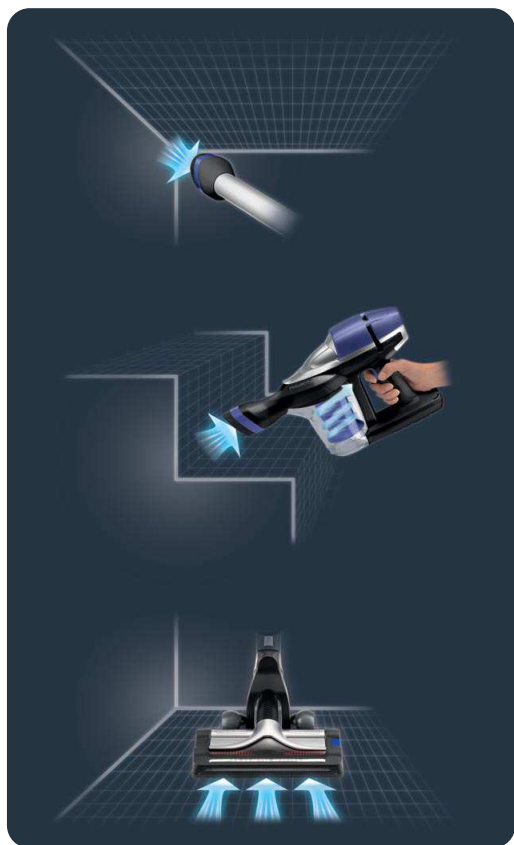

1.  
2. 
3.   
4. 
5. 
6. 
7. 

AIR FORCE™ 360

FR Veuillez lire attentivement le livret "Consignes de sécurité et d'utilisation" avant la première utilisation / **EN** Please read carefully the "Safety and use instructions" booklet before first use / **DE** Lesen Sie vor dem erstmaligen Gebrauch aufmerksam die Broschüre „Sicherheits- und Bedienungshinweise“ durch. / **NL** Gelieve vóór het eerste gebruik aandachtig het boekje met de veiligheids- en gebruiksvorschriften door te nemen / **ES** Lea detenidamente el libro «Instrucciones de seguridad y de uso» antes de utilizar el aparato por primera vez / **PT** Leia atentamente o manual «Instruções de segurança e utilização» antes da primeira utilização / **IT** Leggere con attenzione il libretto "Norme di sicurezza e d'uso" al primo utilizzo / **TR** İlk kullanımdan önce "Güvenlik ve kullanım talimatları" kitapçığını dikkatlice okuyun / **CS** Před prvním použitím si, prosím, pečlivě prostudujte „Bezpečnostní pokyny pro použití“ / **SK** Pred prvým použitím si pozorne prečítajte „Bezpečnostné odporúčania a použitie“. / **HU** Az első használat előtt figyelmesen olvassa el a „Biztonsági előírások és használati útmutató” című fejezetet / **PL** Przed pierwszym użyciem proszę uważnie przeczytać broszurę „Zalecenia dotyczące bezpieczeństwa i użytkowania” / **ET** Palun lugege enne esimest korda kasutamist hoolikalt ohutus- ja kasutusjuhendit / **LT** Atidžiai perskaitykite knygelę „Saugos ir naudojimo reikalavimai“ prieš naudodami įrenginį pirmą kartą / **LV** Pirms izmantojat ierīci pirmoreiz, lūdzu rūpīgi izlasiet brošūru "Norādījumi par drošību un lietošanu" / **BG** Моля, прочетете внимателно книжката "Препоръки за безопасност и употреба" преди първоначална употреба / **RO** Înainte de prima utilizare, citiți cu atenție manualul „Instrucțiuni de siguranță și de utilizare” / **SL** Pred prvo uporabo natančno preberite »Navodila za varno uporabo« / **HR** Molimo da prije prve uporabe pažljivo pročitate priručnik „Sigurnosne upute” / **BS** Prije prve upotrebe pažljivo pročitate knjžicu "Sigurnosne upute" / **SR** Pre prve upotrebe, pažljivo pročitate "Bezbednosno i uputstvo za upotrebu" / **RU** Перед первым использованием внимательно прочитайте инструкцию «Меры безопасности и правила использования». / **UK** Перед першим використанням уважно прочитайте посібник «Правила техніки безпеки та рекомендації щодо використання» / **CN** 请在初次使用本产品前仔细阅读“安全及使用说明” / **HK** 第一次使用前，請仔細閱讀“安全使用說明”小冊子 / **KO** 제품을 처음 사용하기 전에 “안전 주의사항과 사용 방법”에 대한 안내 책자를 주의 깊게 읽으시기 바랍니다 / **AR** يُرجى قراءة كُتَيْبِ السلامة وإرشادات الإستعمال بعناية قبل الإستعمال للمرة الأولى / **FA** قبل از اولین استفاده، لطفاً جزوه "ایمنی و دستورالعمل استفاده" را با دقت بخوانید

FR Pour plus d'informations / **EN** For more information / **DE** Weitere Informationen / **NL** Voor meer informatie / **ES** Para más información / **PT** Para mais informações / **IT** Per ulteriori informazioni / **TR** Daha fazla bilgi için / **CS** Více informací naleznete zde / **SK** Pre viac informácií / **HU** További információk / **PL** Więcej informacji można znaleźć / **ET** Lisateave / **LT** Norėdami daugiau informacijos / **LV** Vairāk informācijas / **BG** За повече информация / **RO** Pentru informații suplimentare / **SL** Več informacij / **HR** Za više informacija / **BS** Za više informacija / **SR** Za više informacija / **RU** Для получения дополнительной информации / **UK** Для отримання докладніших відомостей / **CN** 获取更多信息 / **HK** 更多信息 / **KO** 더 자세한 정보는 아래 웹사이트에서 확인하실 수 있습니다 / **AR** للمزيد من المعلومات / **FA** برای کسب اطلاعات بیشتر

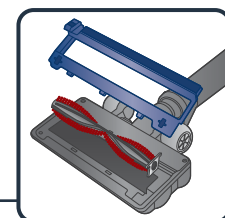
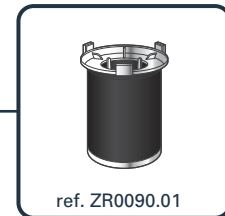
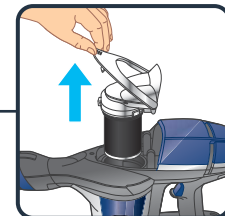
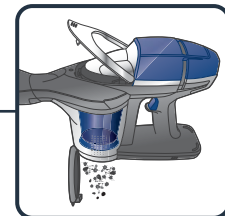
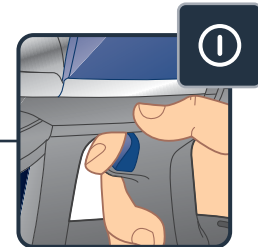
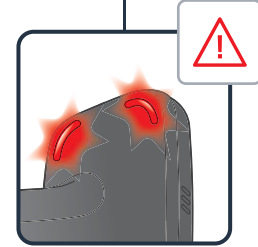
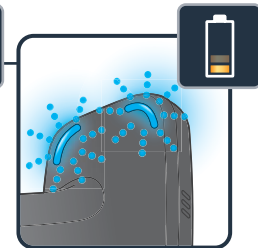
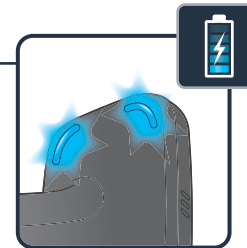
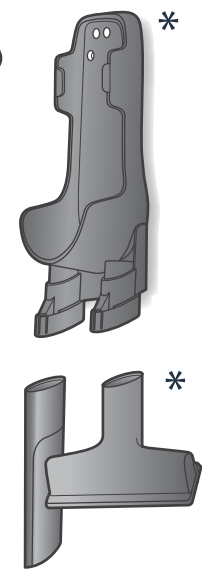
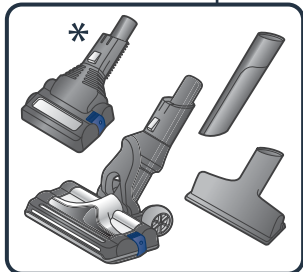
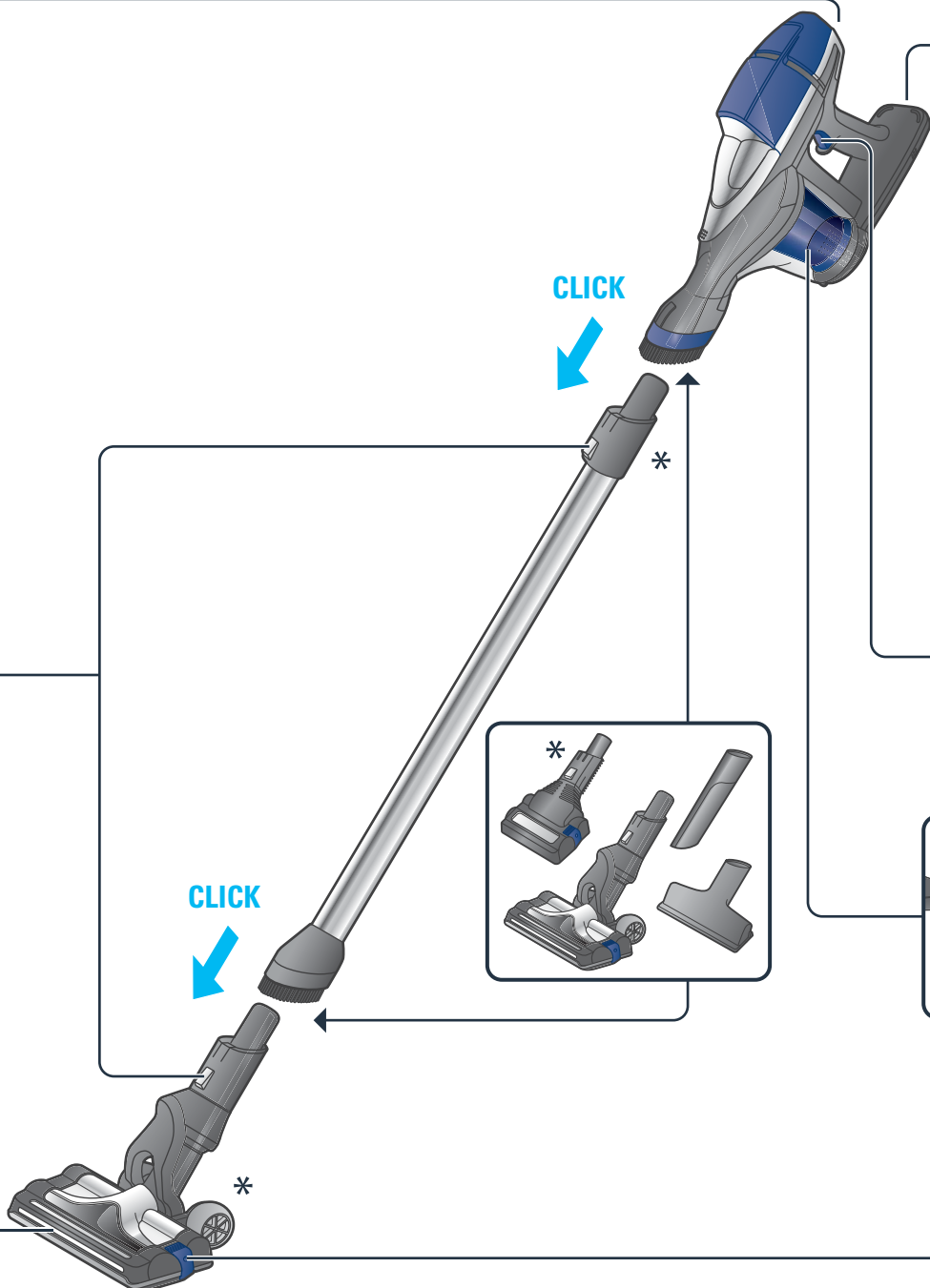
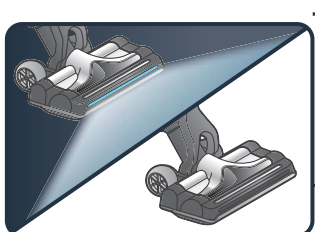
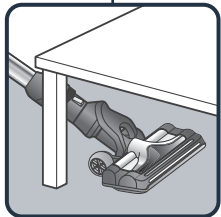
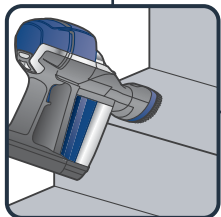
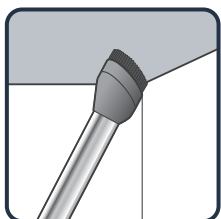
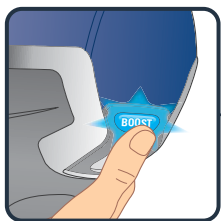

* FR Selon modèle / EN Depending on model / DE Je nach Modell / NL Afhankelijk van het model / ES Según modelo / PT Consoante o modelo / IT Secondo i modelli / TR Modele göre / CS Podle modelu / SK V závislosti od modelu / HU Modelltől függően / PL W zależności od typu / ET Sõltuvalt mudelist / LT Pagal modelį / LV Atbilstoši modelim / BG В зависимост от модела / RO Ovisno o modelu / SL Odvisno od modela / HR Ovisno o modelu / BS Ovisno o modelu / SR U zavisnosti od modela / RU В зависимости от модели / UK Залежно від моделі / CN 根据不同型号 / HK 根據型號 / KO 모델에 따라 다름 / AR حسب الموديل / FA بسته به مدل



1a.

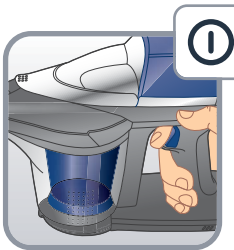
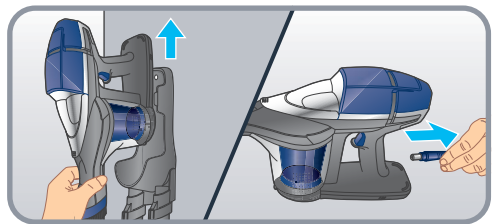
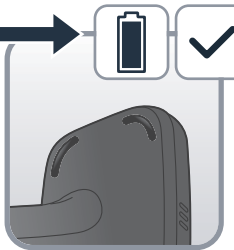
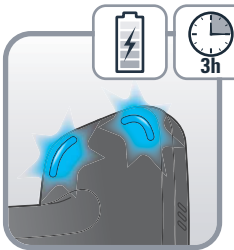
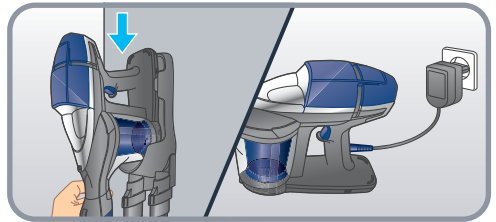
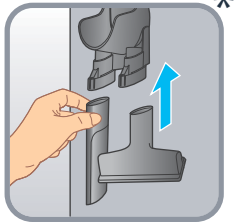
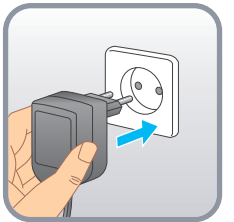
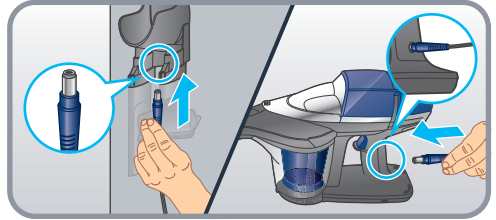
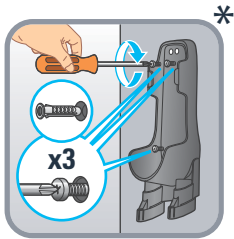
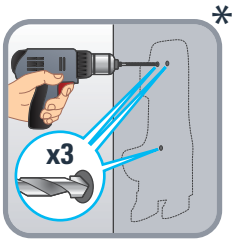
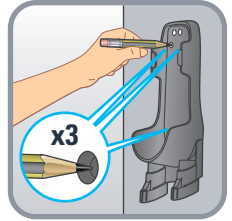

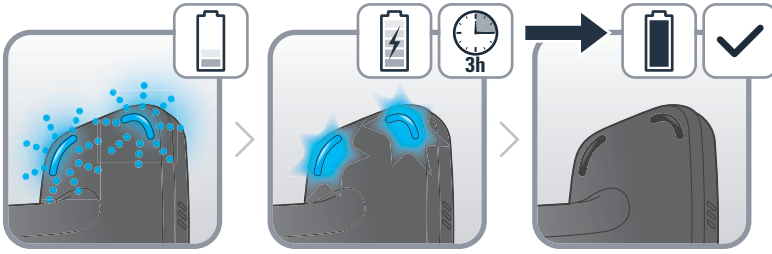

1b.

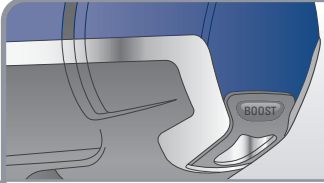
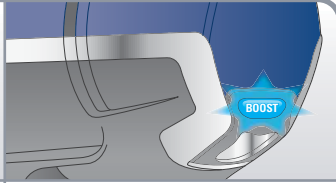
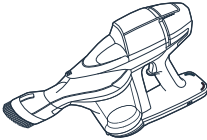
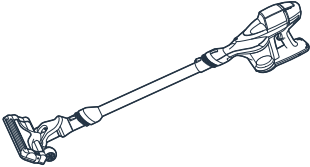

| | | |
|---|---|--|
| |  |  |
|  | 30 min. Max | 14 min. Max |
|  | 20 min. Max | 12 min. Max |

* **FR** Selon modèle / **EN** Depending on model / **DE** Je nach Modell / **NL** Afhankelijk van het model / **ES** Según modelo / **PT** Consoante o modelo / **IT** Secondo i modelli / **TR** Modele göre / **CS** Podle modelu / **SK** V závislosti od modelu / **HU** Modelltől függően / **PL** W zależności od typu / **ET** Sõltuvalt mudelist / **LT** Pagal modelį / **LV** Atbilstoši modelim / **BG** в зависимост от модела / **RO** Ovisno o modelu / **SL** Odvisno od modela / **HR** Ovisno o modelu / **BS** Ovisno o modelu / **SR** U zavisnosti od modela / **RU** В зависимости от модели / **UK** Залежно від моделі / **CN** 根据不同型号 / **HK** 根據型號 / **KO** 모델에 따라 다름 / **AR** حسب الموديل / **FA** بسته به مدل

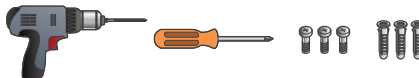

* * **FR** Non inclus / **EN** Not included / **DE** Nicht im Lieferumfang enthalten / **NL** Niet inbegrepen / **ES** No incluidos / **PT** Não incluídos / **IT** Non incluso / **TR** Dahil değil / **CS** Není součástí balení / **SK** Nezahnuté / **HU** Nem tartozék / **PL** Nie zawiera / **ET** Välja arvatud / **LT** Nėra įtraukta / **LV** Nav ietverts / **BG** Не са включени / **RO** Neinclus / **SL** Ni vključeno / **HR** Nisu uključeni / **BS** Nije uključeno / **SR** Nije uključeno / **RU** Не включено / **UK** Не включено / **CN** 不包括 / **HK** 不包含 / **KO** 포함되지 않음 / **AR** غير مرفقة / **FA** شامل نمی شود

2.

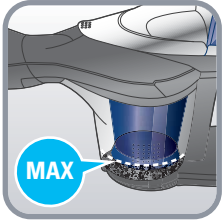
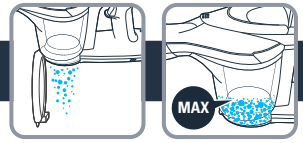

3a.

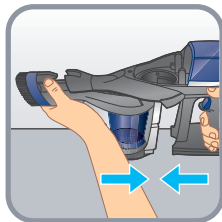
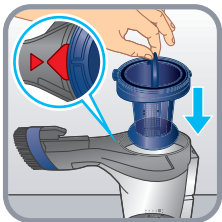
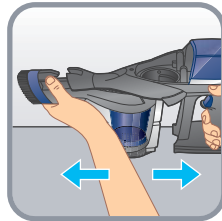
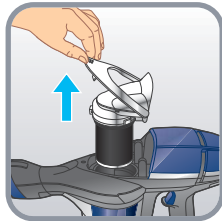
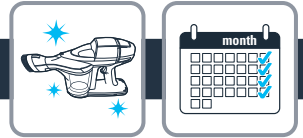

3b.

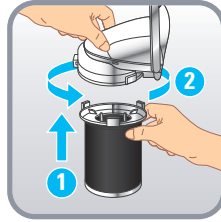
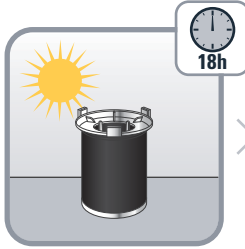
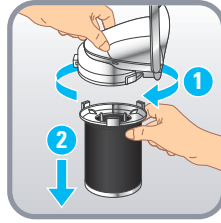
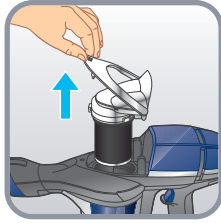

3c.

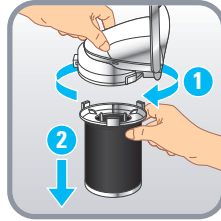

4.

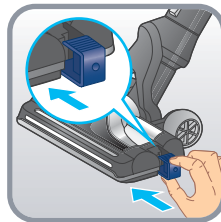
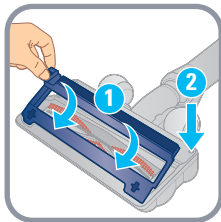
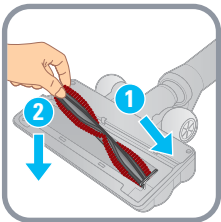
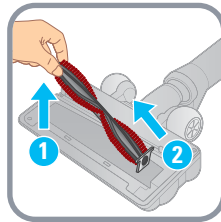
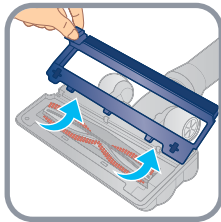
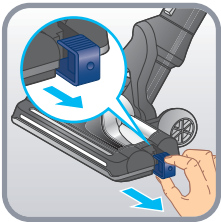

5.

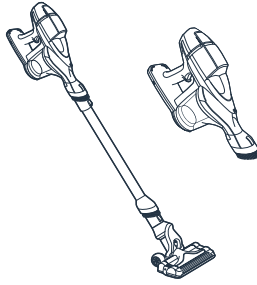

✓ >



✗ >

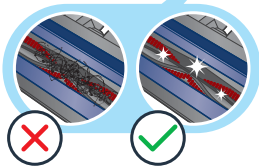
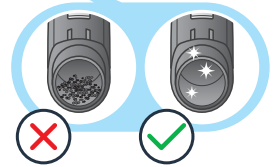
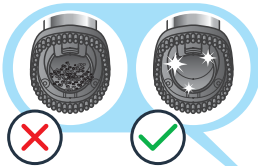
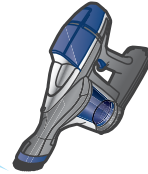
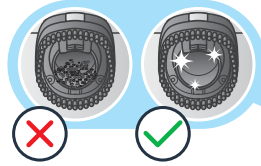



7.

