



MONTAGEANLEITUNG

Wir bitten Sie, UNBEDINGT die Reihenfolge zu beachten!

ASSEMBLY INSTRUCTIONS

It is IMPORTANT that you follow phase by phase all instructions!

Ident.-Nr
1500320

040302-0

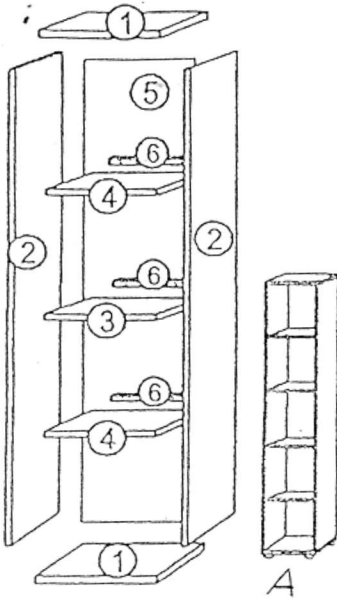
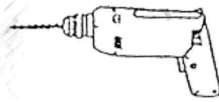
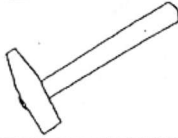

	A	B	C	D	E	F	G	H	I	J	K
Art.:	16 mm 	12,5 mm 									
D		8x	6x	8x	4x	4x	2x			1x	2x
C		8x	8x	12x	5x	5x	2x			1x	2x
B	4x	8x	12x	20x	5x	5x	2x	8x	16x	1x	2x
A	8x	8x	16x	24x	6x	6x	2x	8x	16x	1x	2x

Artikelnr.

4067.277
4067.089
4067.090

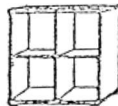

B

C

D

Sehr geehrter Kunde, sollte ein Teil fehlen oder beschädigt sein, kreuzen Sie bitte dieses deutlich auf der Montageanleitung an und schicken die Montageanleitung mit ein. Bitte geben Sie bei Reklamationen die QS-Kontrollnummer an. Diese finden Sie auf dem Verpackungsaufkleber!

Dear customer, should there be any piece missing or damaged, kindly mark this piece clearly on the attached assembly instructions and return it to us. In case of any claims, please indicate the QS-number (quality control number). You can find the number on the package label!

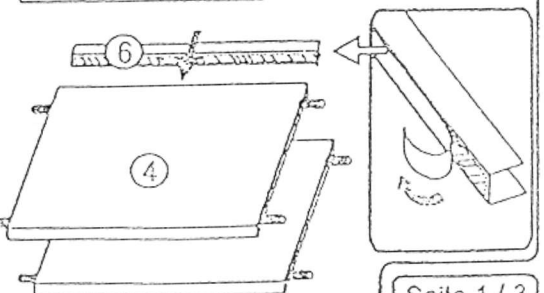
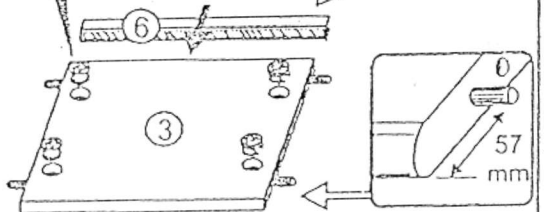
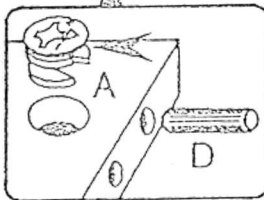
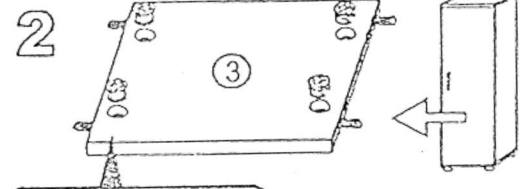
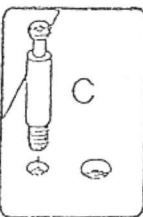
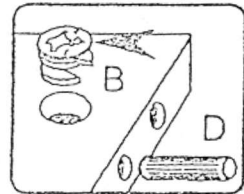
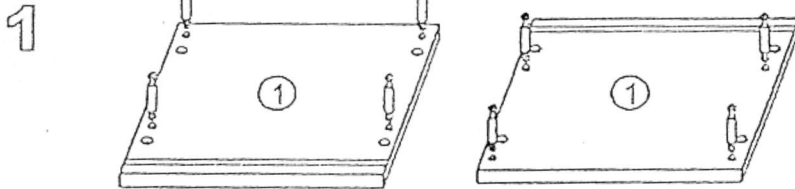

Seite 1 / 3

6889733

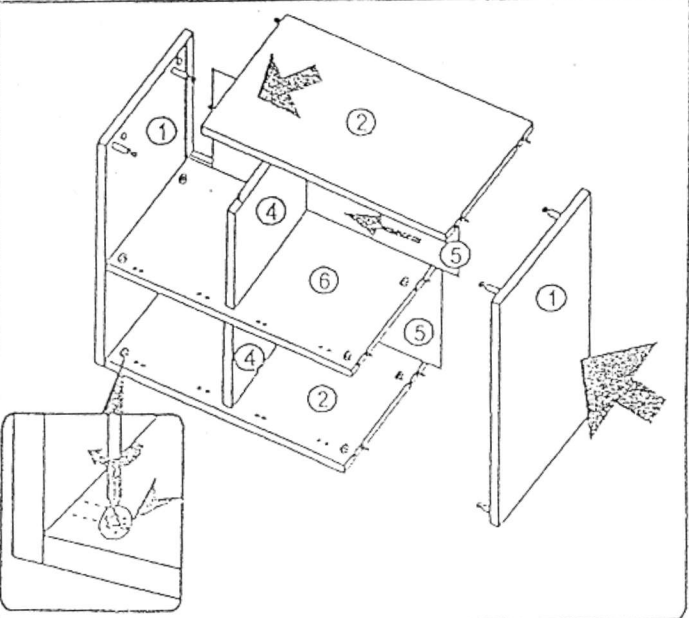
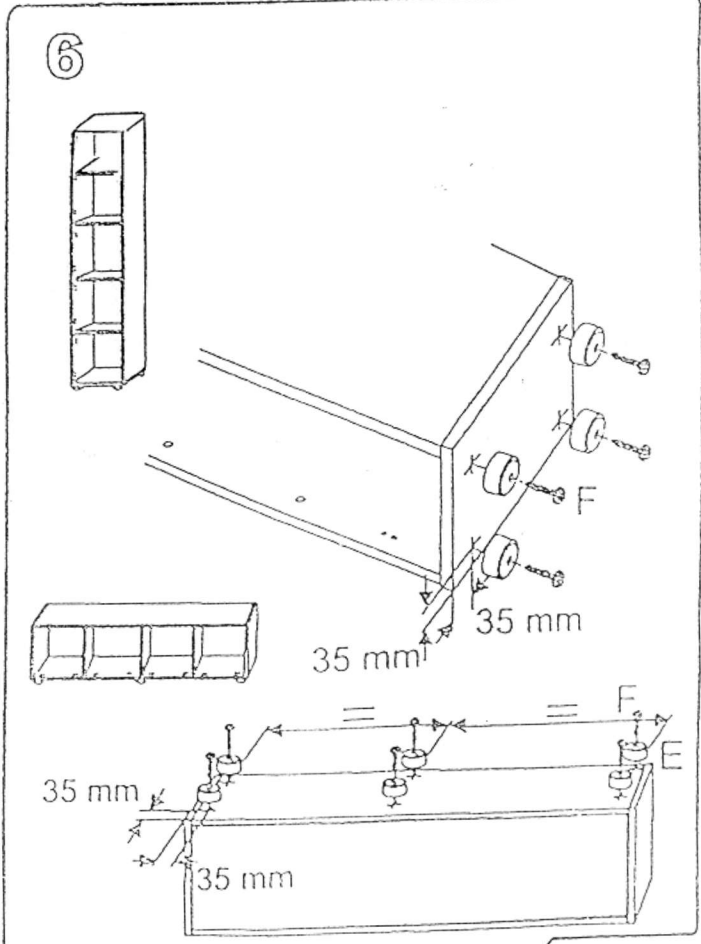
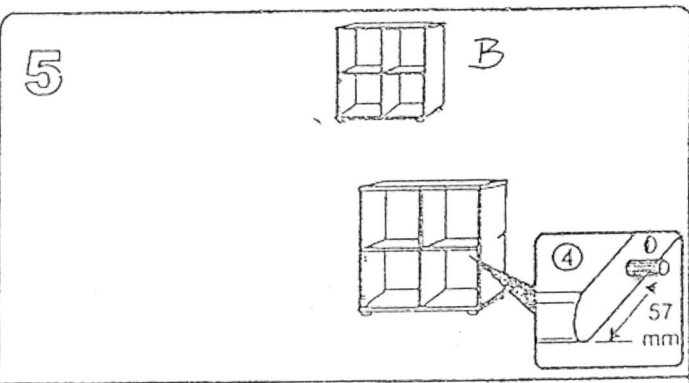
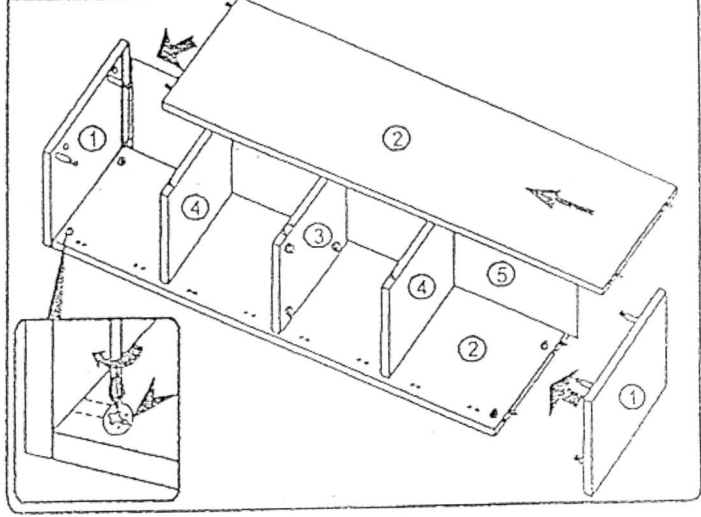
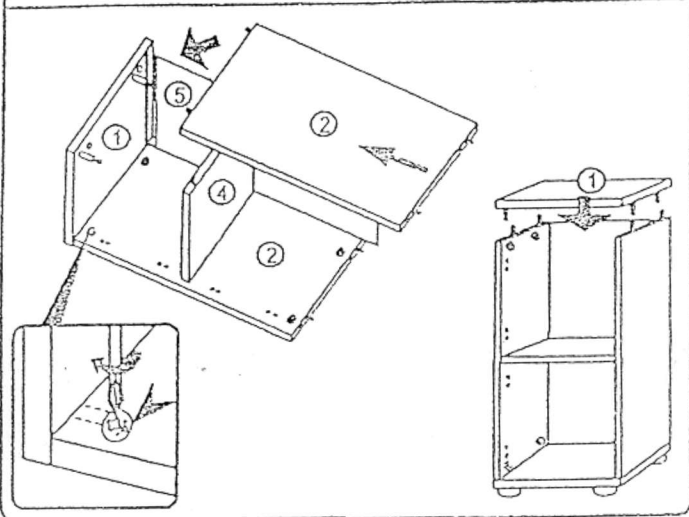
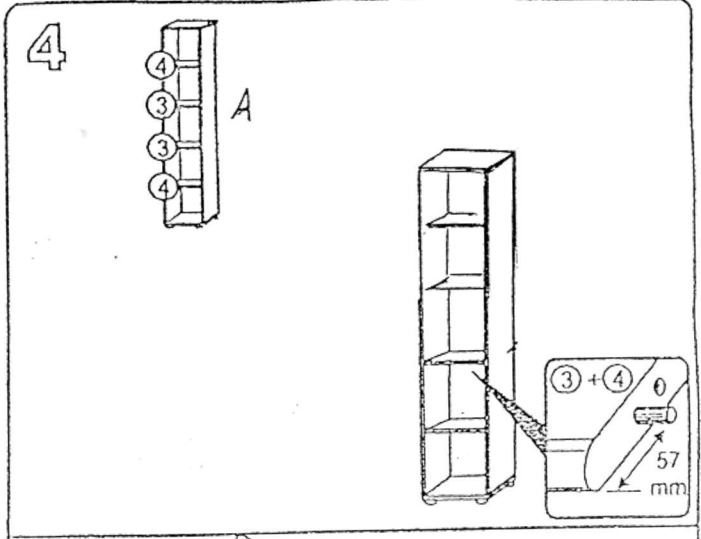
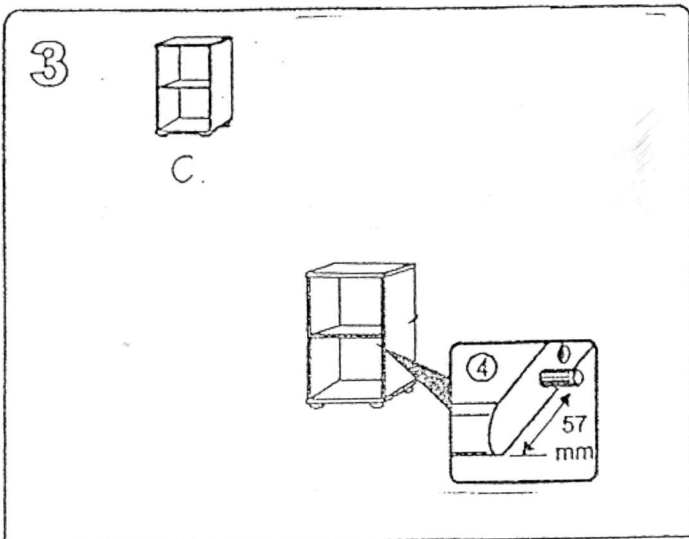

7

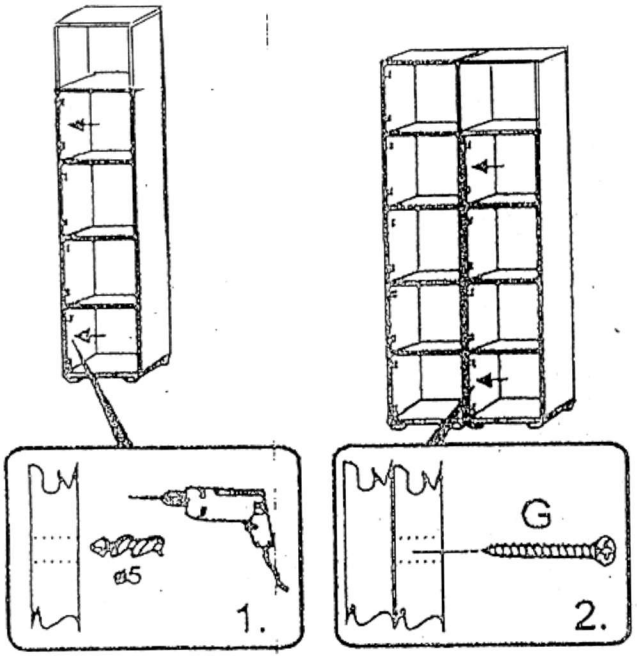

8

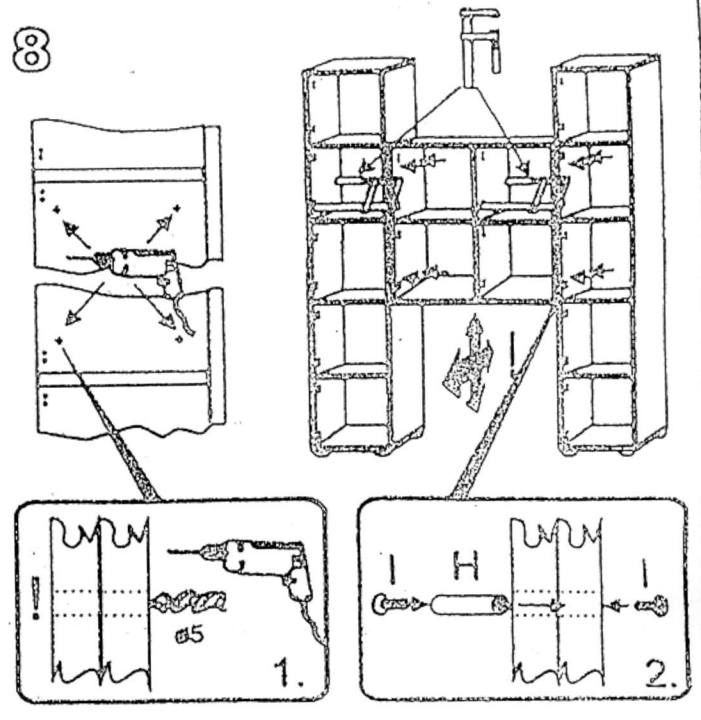

Achtung!
 Um ein Ausreißen beim Durchbohren zu vermeiden, sollte auf der Gegenseite ein Klotz vorgehalten werden!
Warning!
 Be careful not to tear surface when drilling. Use wooden block as a precaution on other side!
Important!
 Pour empêcher le bois d'éclater le bois lors du perçage traversant, maintenez une cale contre le côté opposé!

9

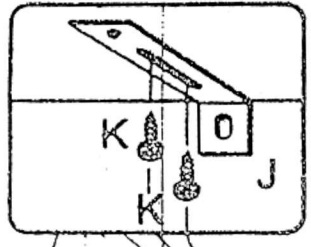

ACHTUNG! Wandbefestigung aus Sicherheitsgründen unbedingt einbauen!
 Beigefügtes Wandbefestigungsmaterial ist nur für Massivwände geeignet. Zur Befestigung an anderen Wänden müssen Spezialdübel verwendet werden.

WARNING! For reasons of safety always use wall bracket!
 The supplied wall bracket and fastening material is only suited for solid walls. Use specialised wall plugs for other wall materials.

IMPORTANT! Par raison de sécurité, il est indispensable de fixer le meuble à la paroi!
 Les chevilles conviennent seulement pour des murs en dur. Pour d'autres types de parois, il faut utiliser des chevilles spéciales.

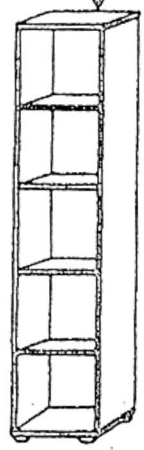

A.

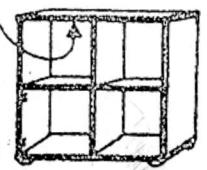

B.

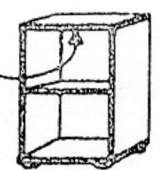

C.

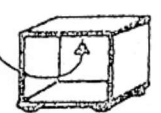

D.