

RAMSES'S Pyramid



3843





1

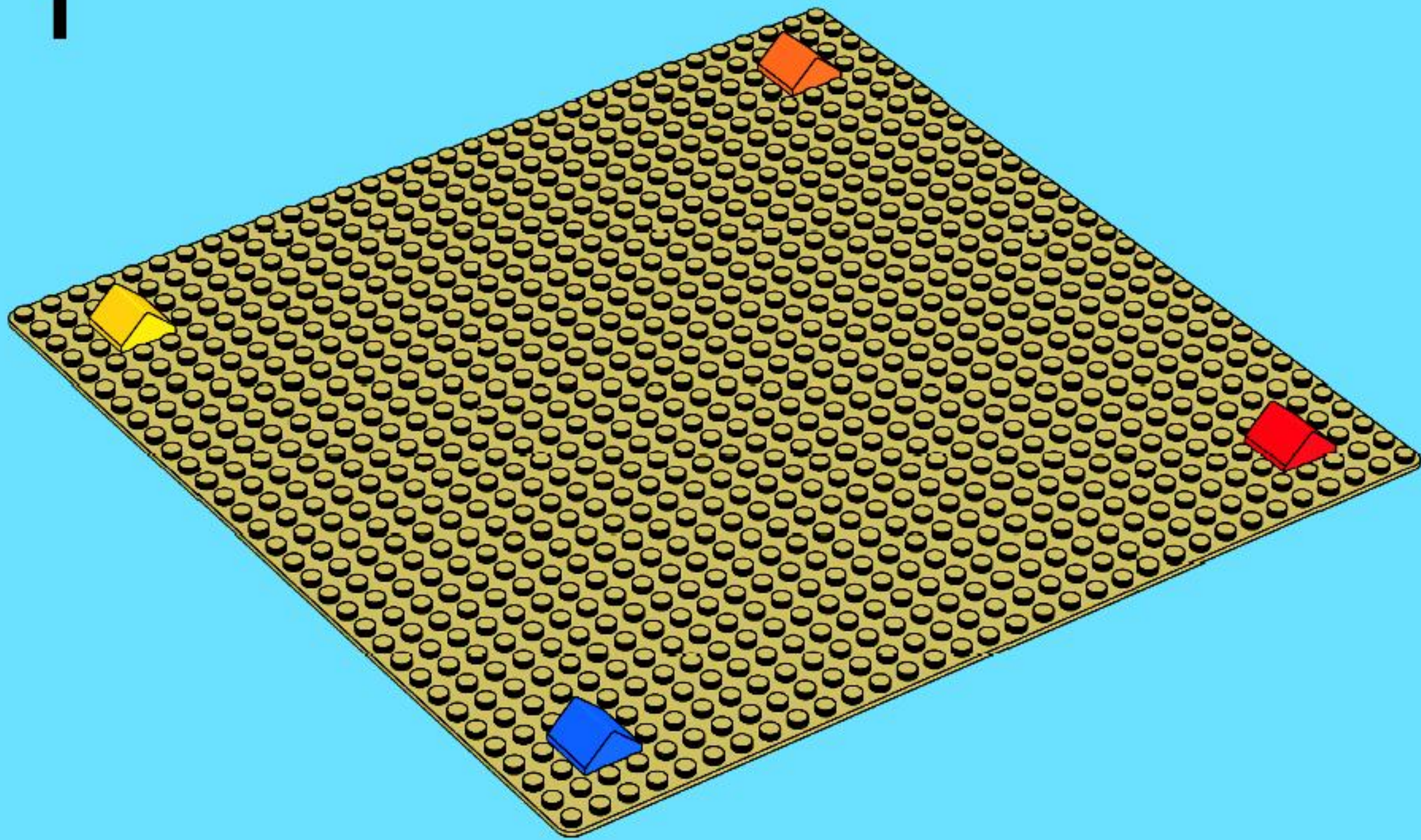

2

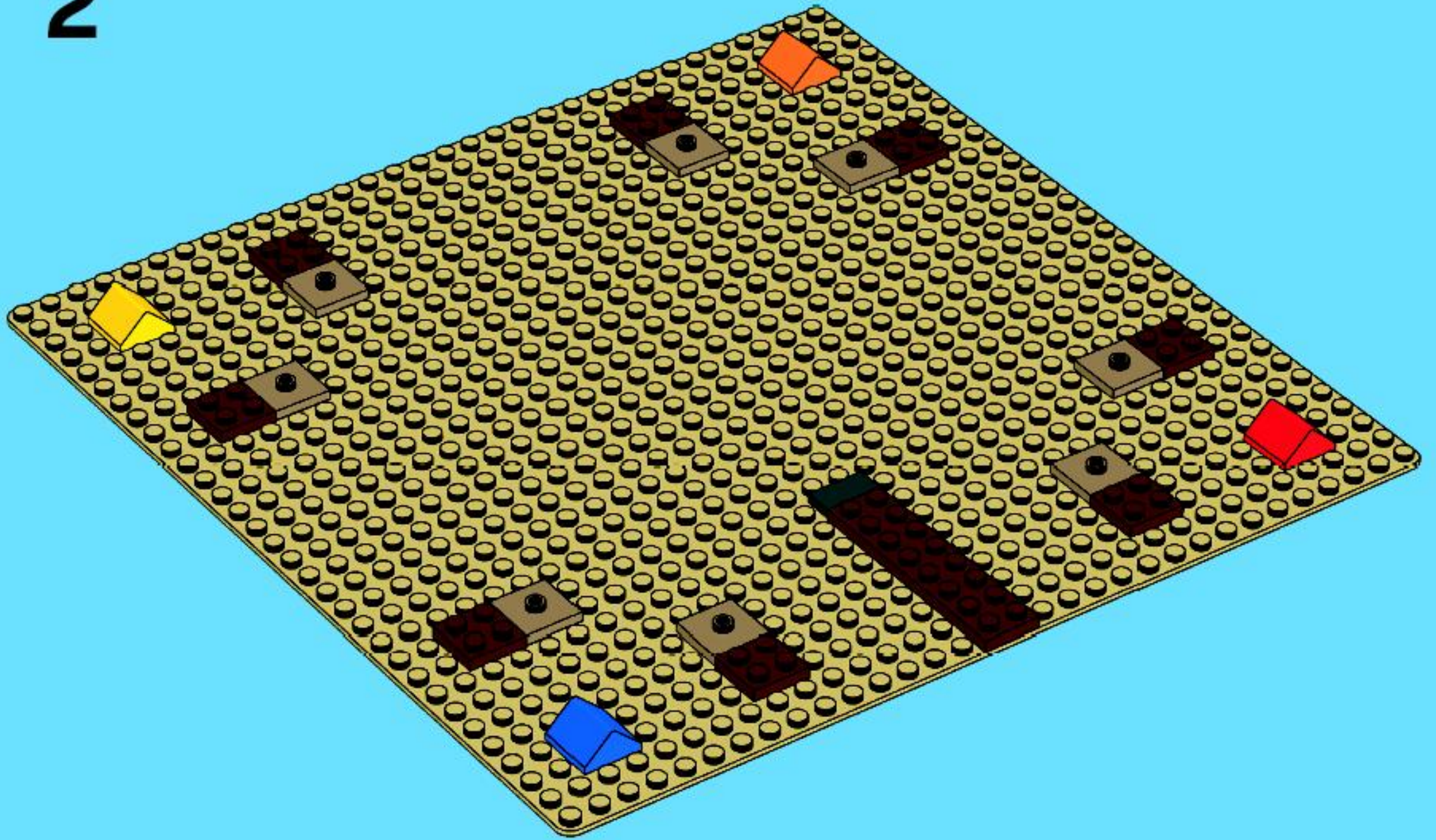

3

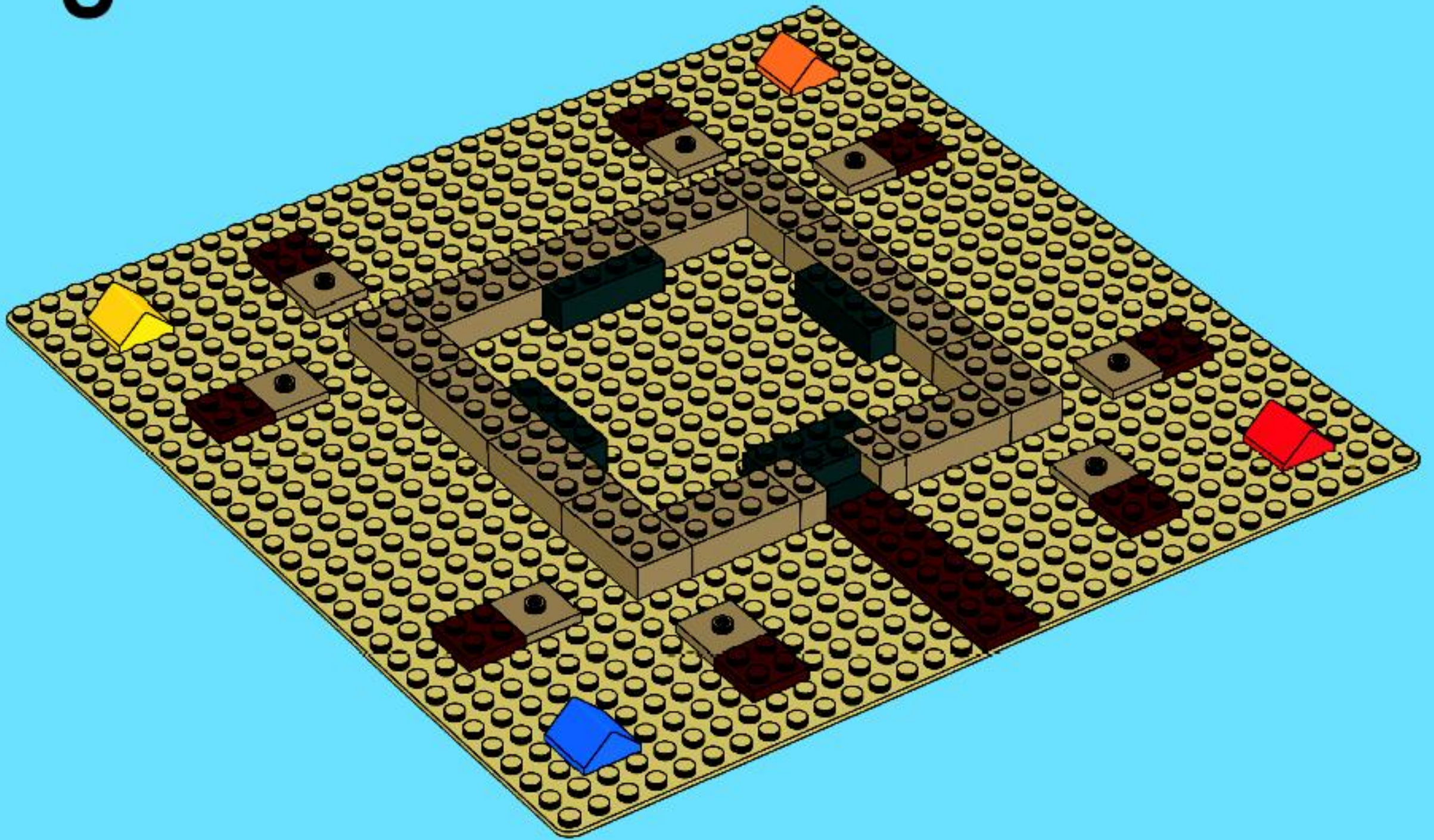

4

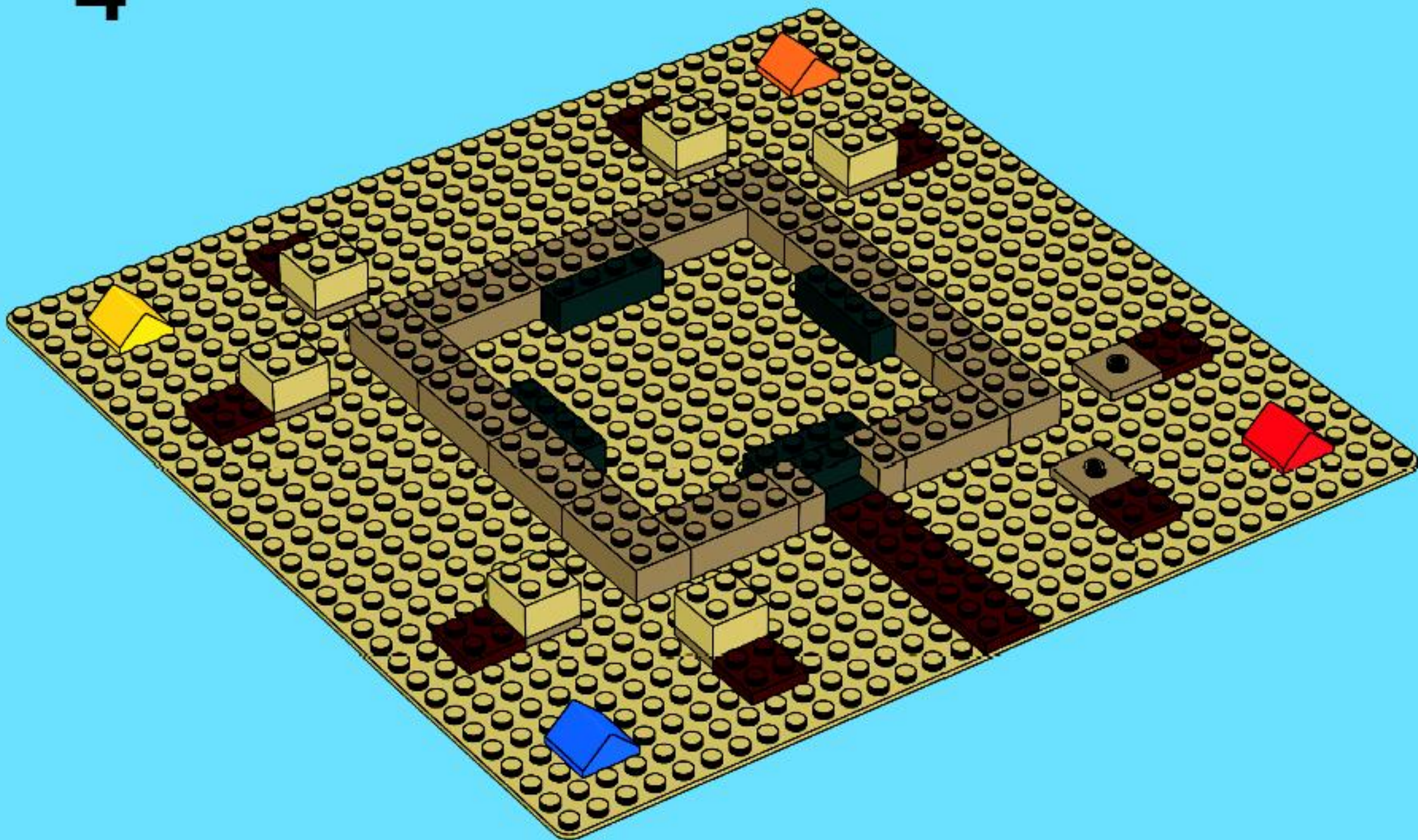

5



6



7



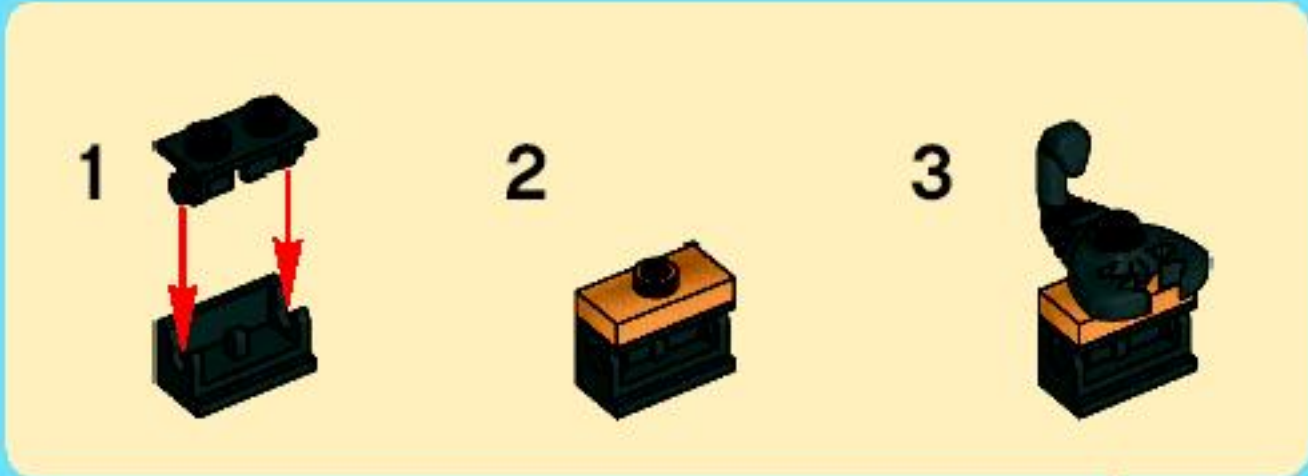

8



1

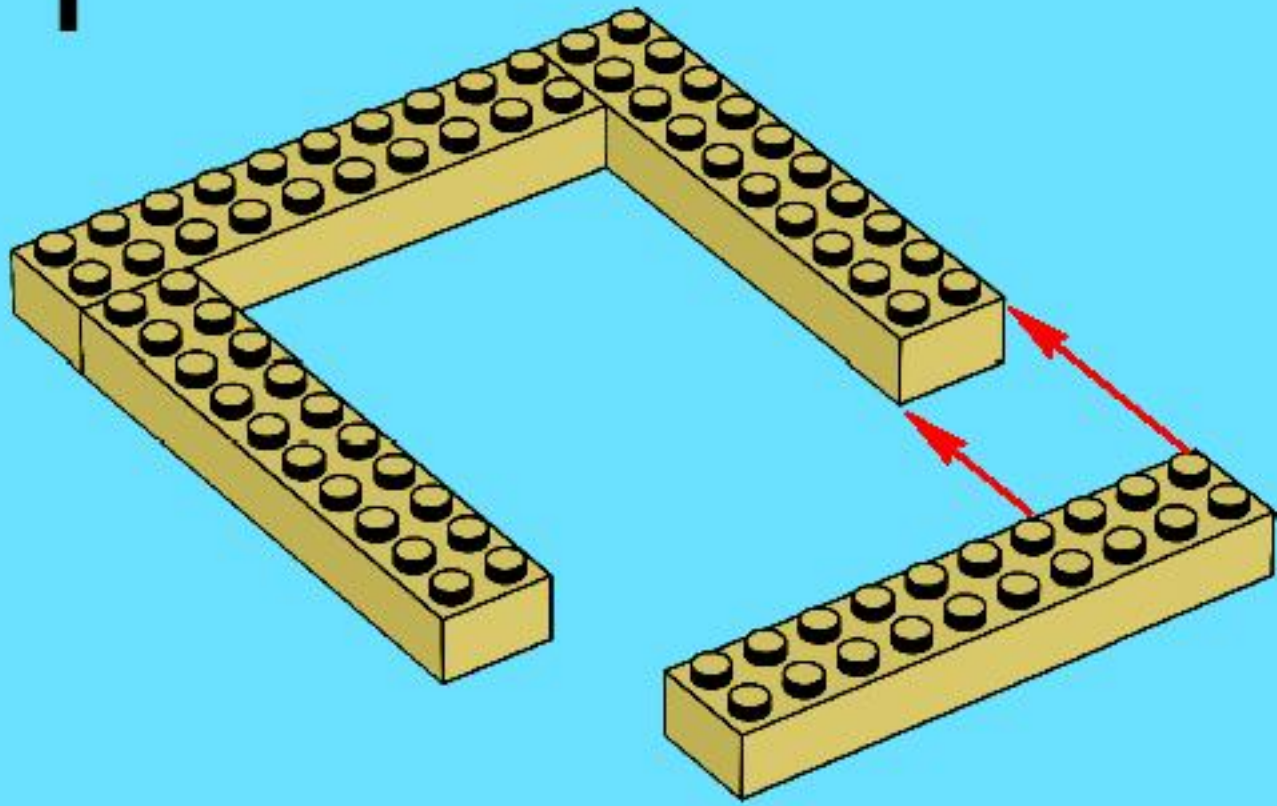

2

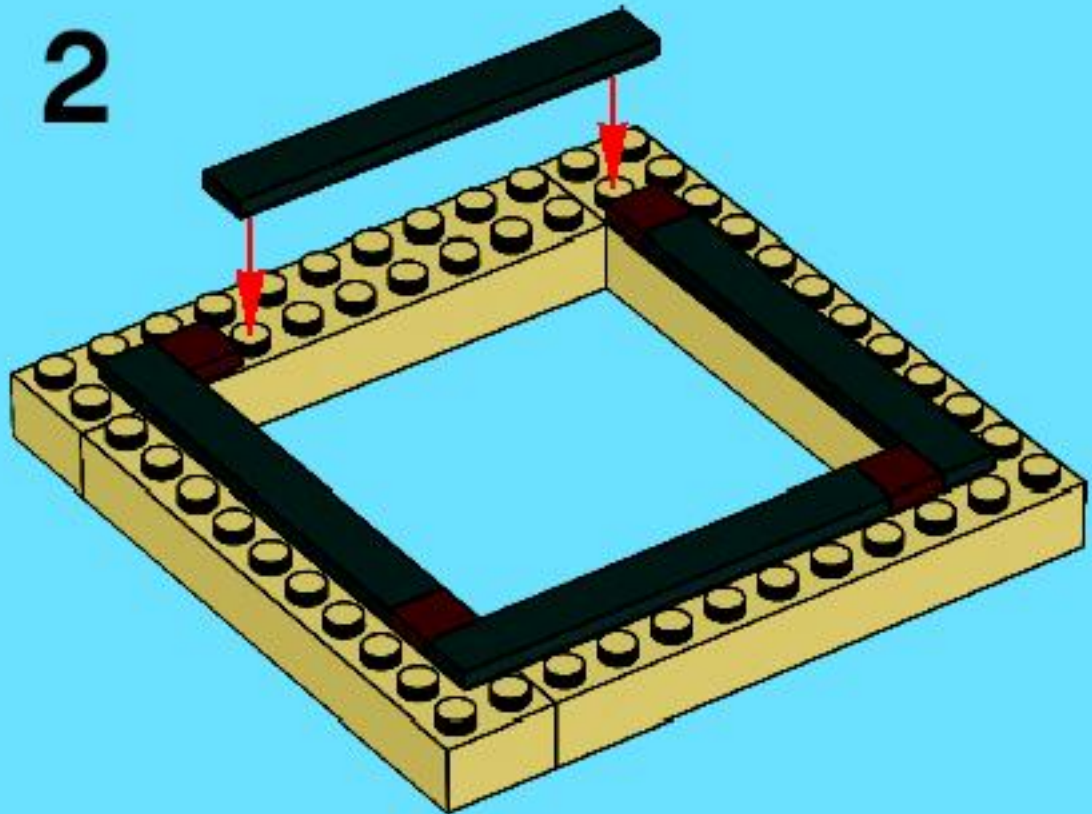

3

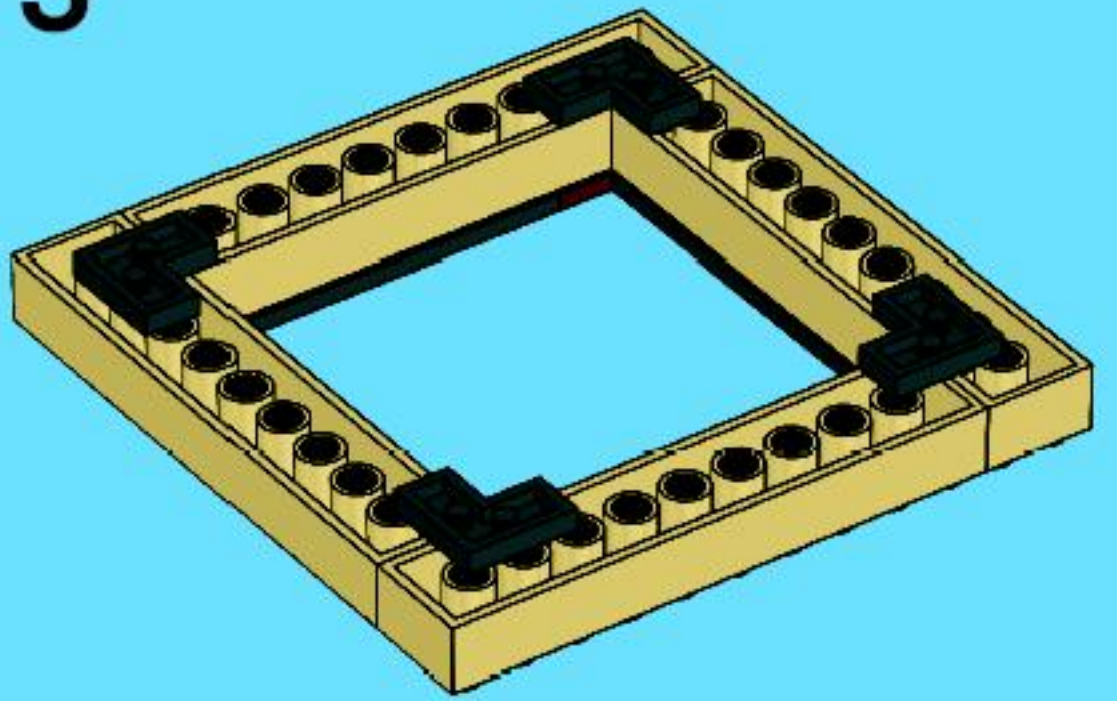

4

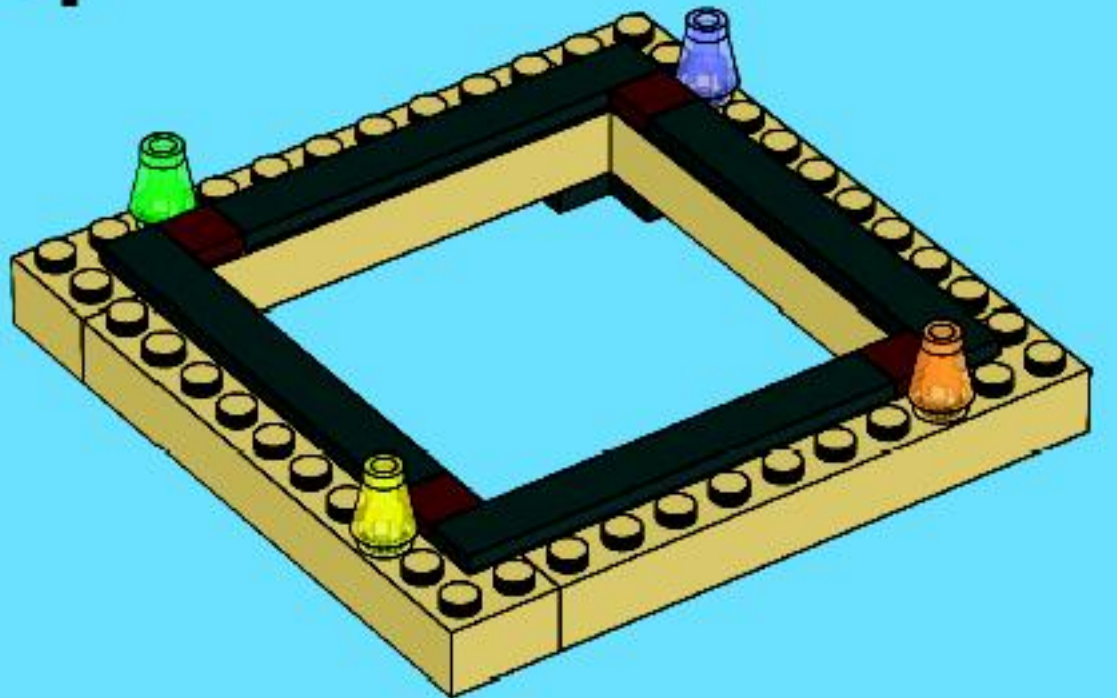

9



1

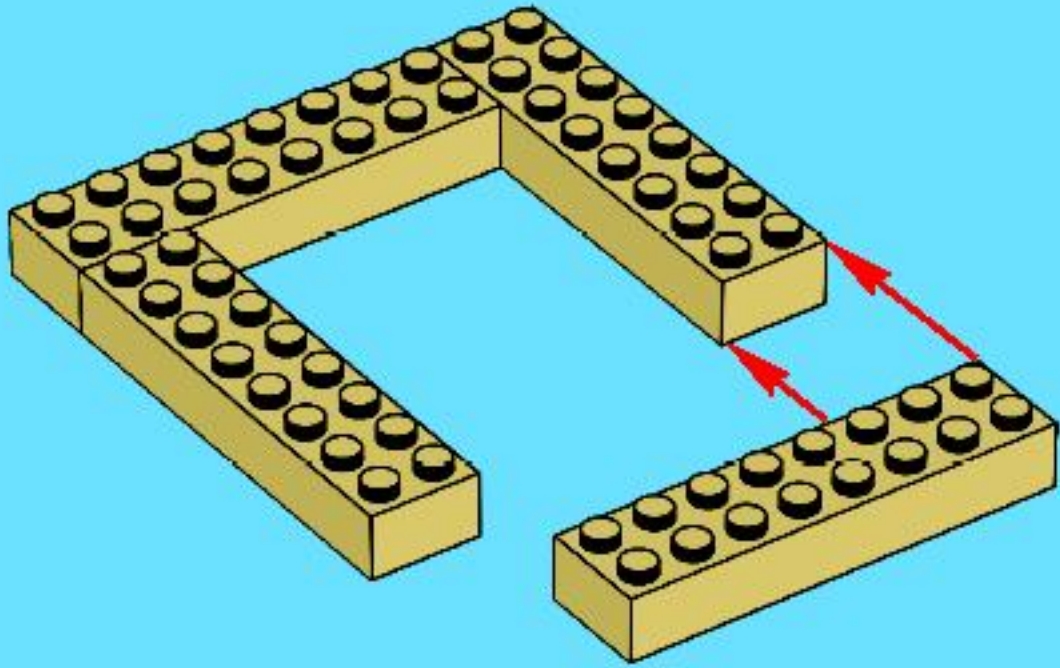

2

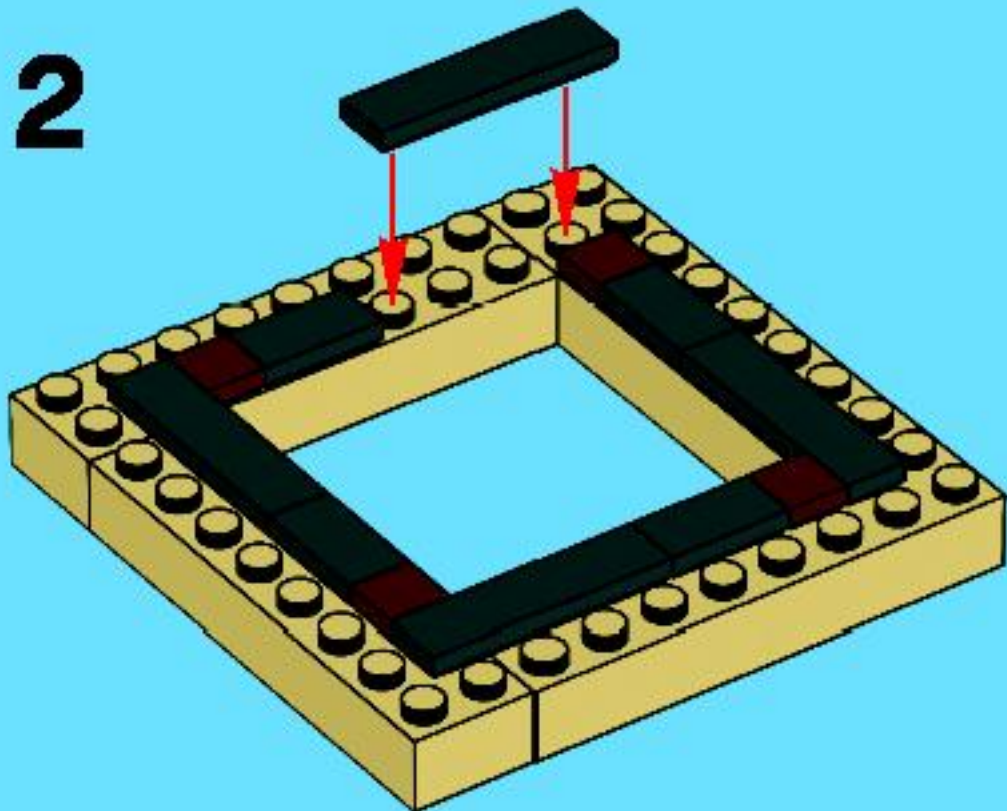

3

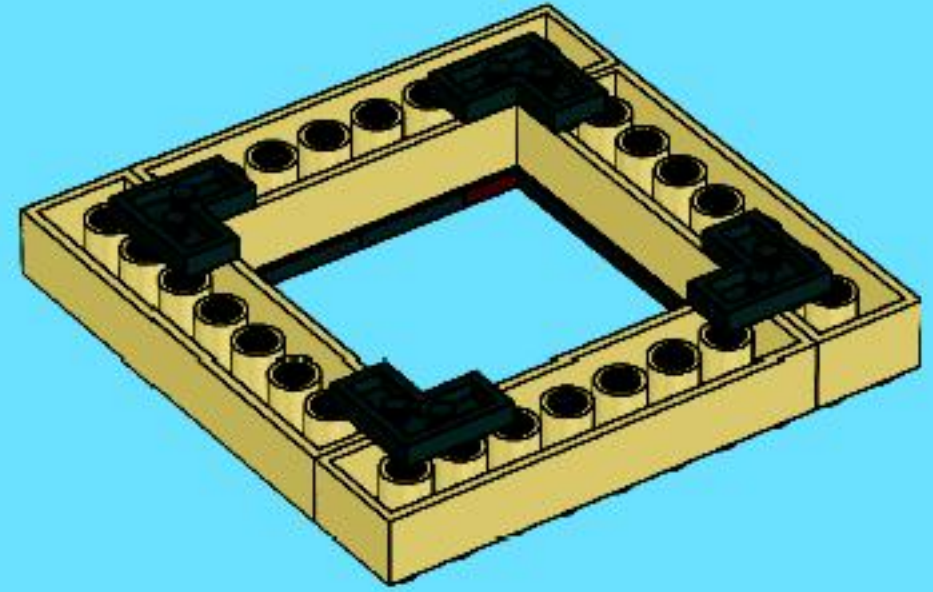

4

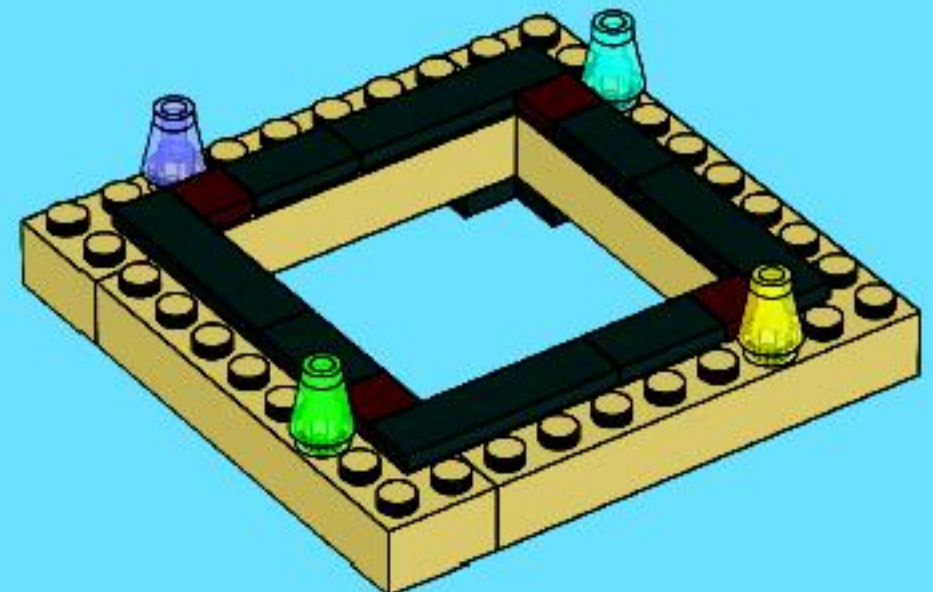

10



1

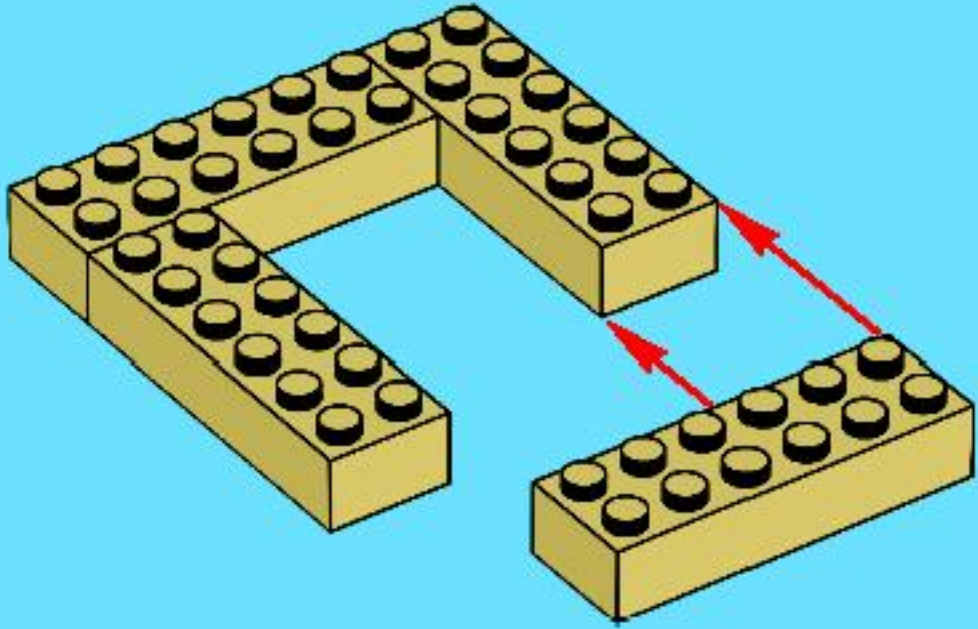

2

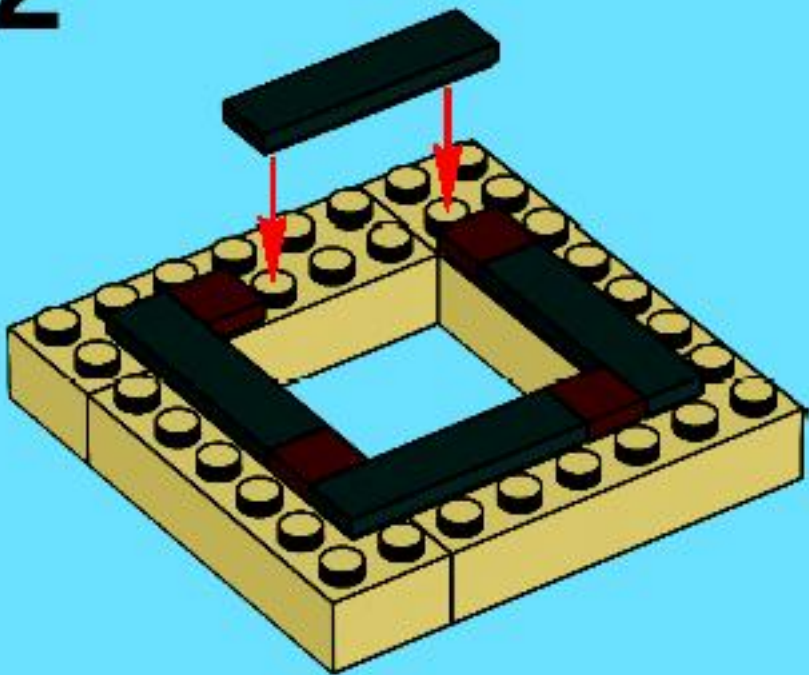

3

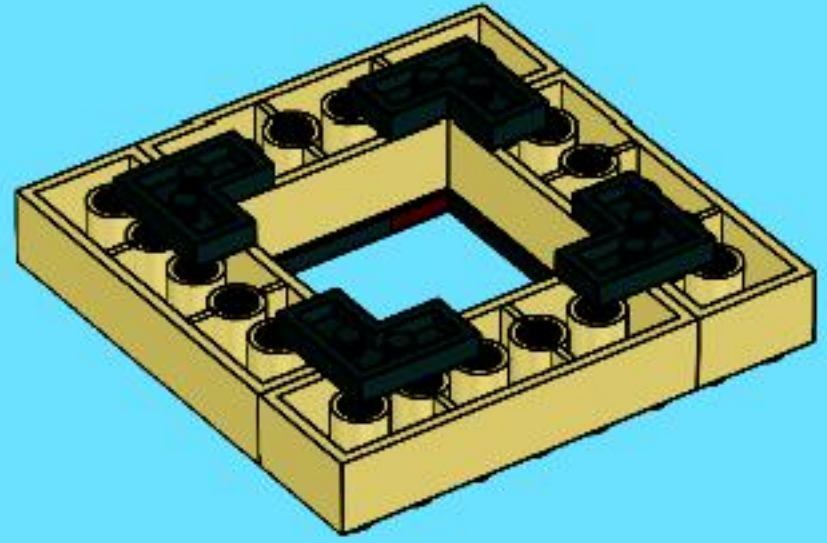

4

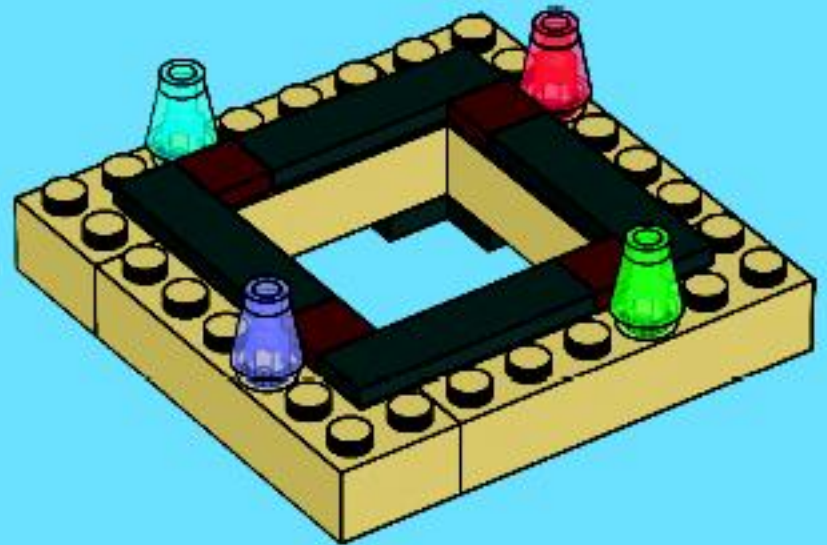

11

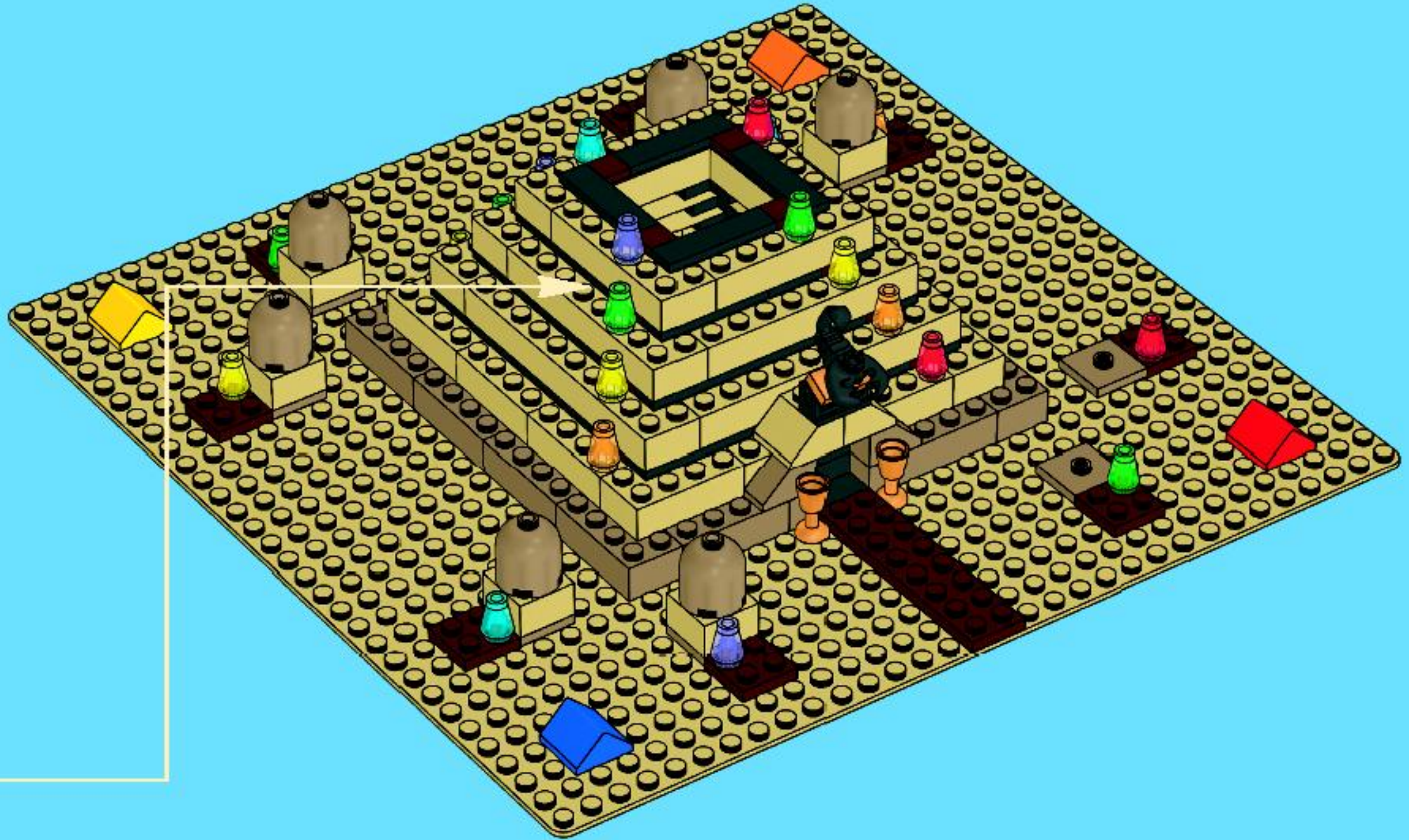

1

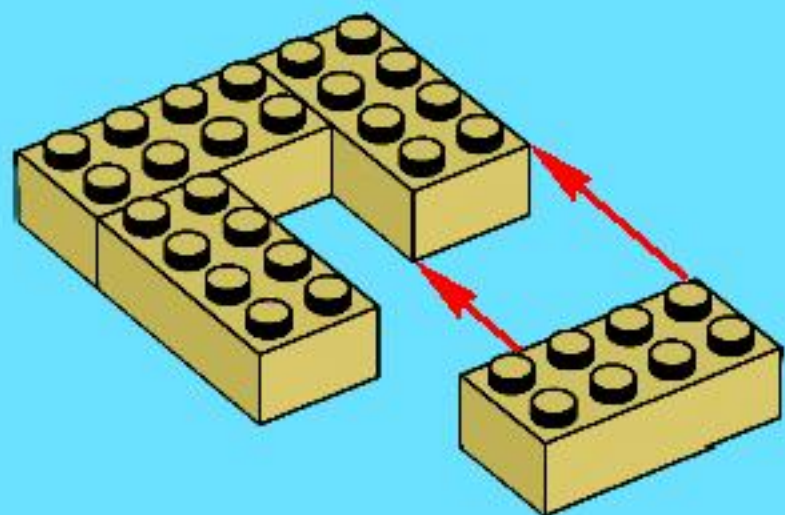

2

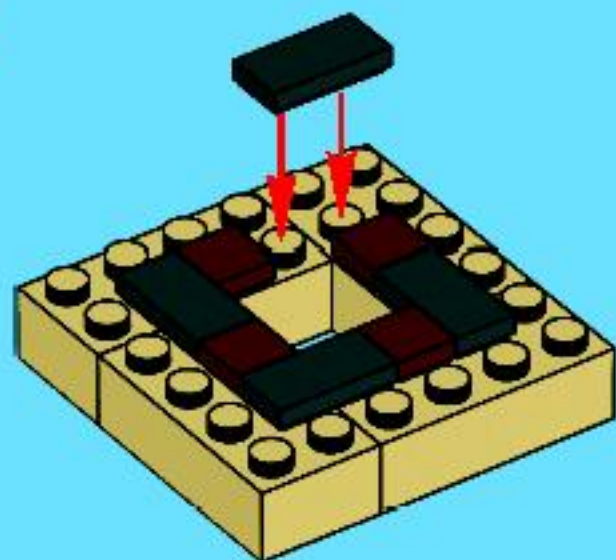

3

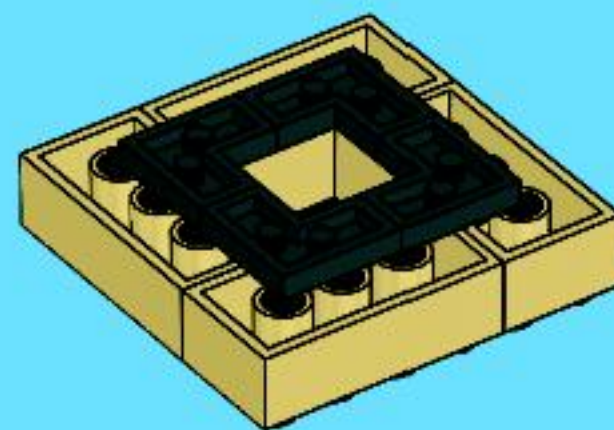

4



12



1

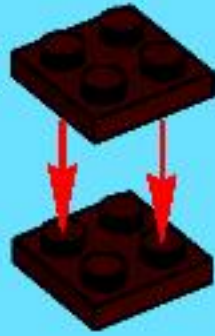

2

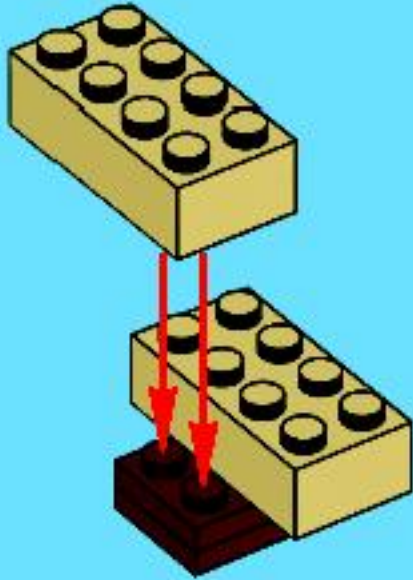

3

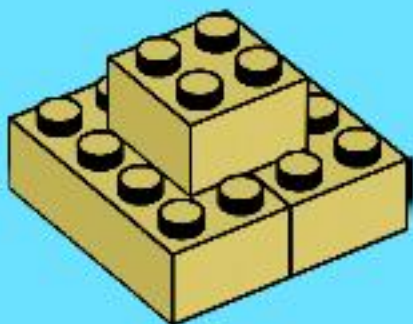

4

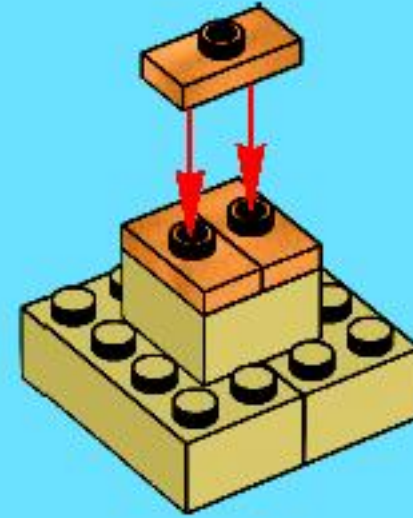

5

















































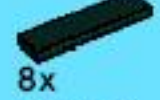



6



13



-  1x
4560463
-  8x
4560464
-  1x
4560473
-  1x
4540383
-  2x
4560815
-  2x
4560646
-  20x
4211288
-  10x
4216695
-  1x
4211211
-  8x
4114306
-  17x
4114319
-  4x
4181134
-  4x
4141533
-  4x
4522675
-  2x
4114322
-  1x
4560460
-  1x
4560575
-  6x
4567332
-  7x
4567333
-  2x
4521914
-  13x
4247145
-  6x
4558697
-  2x
4530678
-  8x
4560545
-  1x
4560434
-  1x
4560461
-  1x
304321
-  6x
4544720
-  1x
4560462
-  4x
4523157
-  6x
4505990
-  1x
4516816
-  1x
4557385
-  6x
4567338
-  1x
300426
-  4x
301026
-  1x
300326
-  16x
242026
-  13x
306926
-  8x
243126
-  8x
416226
-  1x
4558611
-  1x
4551360
-  1x
393826
-  1x
400626
-  1x
393726
-  1x
4539364
-  7x
4567340
-  6x
4567331
-  1x
4560573
-  1x
4560459

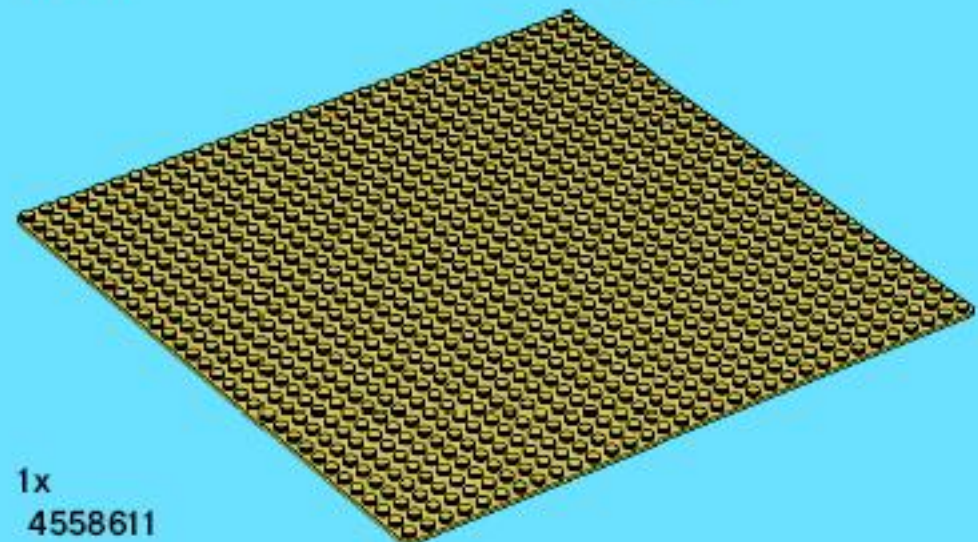

Customer Service
 Kundenservice
 Service Consommateurs
 Servicio Al Consumidor
www.lego.com/service or dial

00800 5346 5555 :     

1-800-422-5346 :  

FREE! GRATIS! GRATUIT!



club
MAGAZINE™

www.LEGOclub.com



00800 5346 5555*        

  1-866-534-6258 • 1-877-518-5346

US & Canada only

Canada seulement



VISIT THE WORLD'S
BIGGEST LEGO® SHOP!

www.LEGOshop.com

* FreePhone. Mobile charges may apply. ** Numéro sans Frais. Des Frais peuvent s'appliquer avec les téléphones cellulaires. *** Gebührenfrei, kosten Rufnummern aus Mobilfunknetzen können abweichen. **** Gratisk telefontalnummer vanaf vastlijn. ***** Het gratis nummer, vóór de ringen Fra Postboks. ***** Le numéro gratuit, vóór de ringen Postboks. ***** Gratisk telefontalnummer vanaf vastlijn. ***** Het gratis nummer, vóór de ringen Postboks. ***** Le numéro gratuit, vóór de ringen Postboks.

MINOTAURUS



3841
Minotaurus
2-4 7+ 20-30



3838
Race 3000
2-4 7+ 10-20



3840
Pirate Code
2-4 9+ 15-25

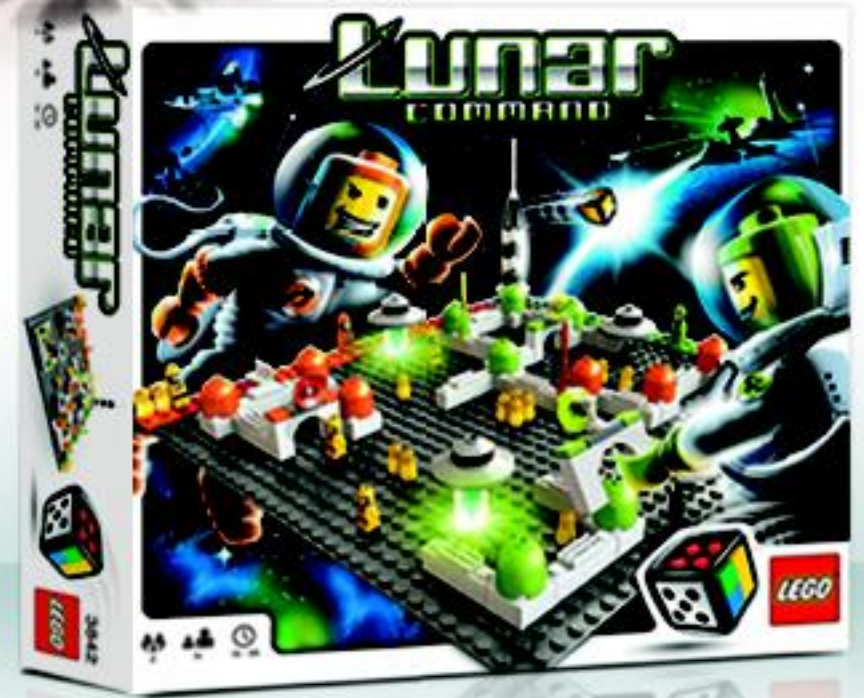

3842
Lunar Command
2 7+ 15-30



3835
Robo Champ



3836
Magikus



3837
Monster4



3838
Lava Dragon



3843
Ramses Pyramid

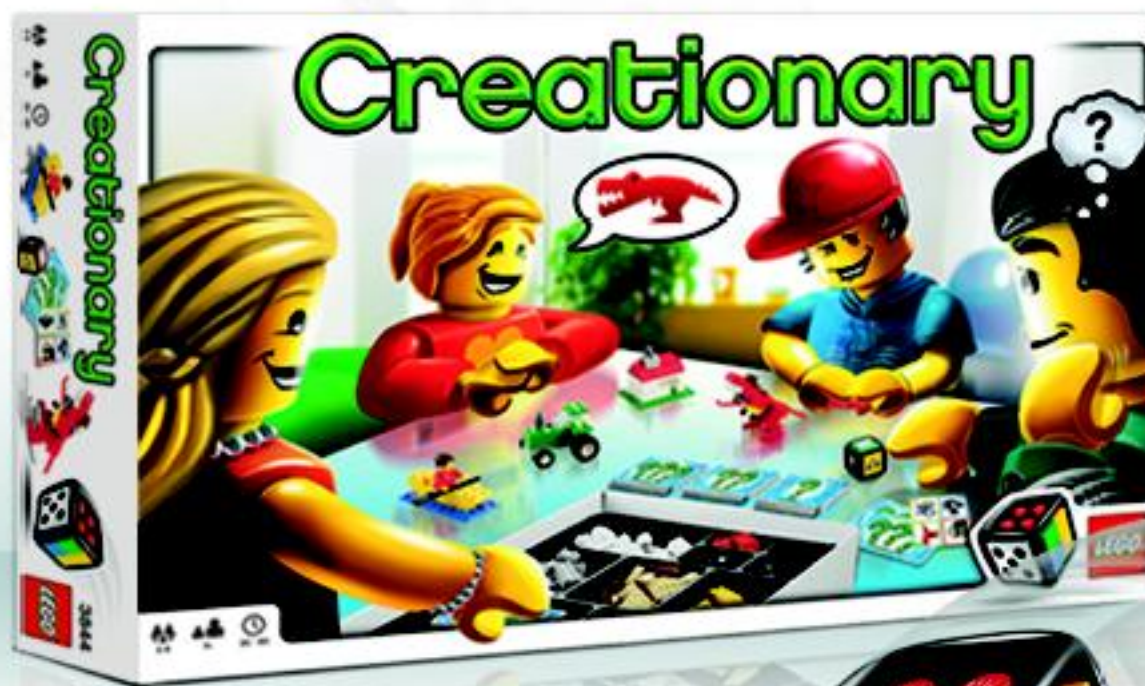

3844
Creationary



www.nielsen.com/LEGO



WIN LEGO® PRODUCTS

Fill out a survey and you might WIN a cool LEGO product
NO PURCHASE NECESSARY

Open to all residents where not prohibited
Go to www.nielsen.com/LEGO to fill out a survey for a chance to win a LEGO product.

WIN LEGO® PRODUCTEN

Vul een enquêteformulier in en maak kans op een cool LEGO® product!
Kopen niet nodig
Iedereen uit landen waar geen enquêteverbod geldt mag deelnemen.
Ga naar www.nielsen.com/LEGO, vul een enquêteformulier in en maak kans op een LEGO product.

GEWINNE LEGO® PRODUKTE

Nimm an der Umfrage teil und GEWINNE ein tolles LEGO® Produkt!
Die Teilnahme am Gewinnspiel führt zu keinerlei Kaufverpflichtungen
Teilnahme in allen nicht ausgeschlossenen Ländern möglich
Wir verlosen unter allen Teilnehmern der Umfrage auf www.nielsen.com/LEGO LEGO Produkte.

GAGNE DES PRODUITS LEGO®

Réponds à un questionnaire et tu pourrais GAGNER un produit LEGO® très cool !
Aucune obligation d'achat
Ouvert à tous les résidents des pays autorisés.
Visite www.nielsen.com/LEGO pour répondre à un questionnaire et avoir une chance de gagner un produit LEGO.

レゴ®製品を「当てよう」

アンケートに記入して、かっこいいレゴ®製品を当てよう！
お買い上げの必要はありません。
禁止されていない限り、すべての皆様にご利用いただけます。
www.nielsen.com/LEGOにアクセスして、アンケートにご記入ください。当選者にはレゴ®製品を差し上げます。

