

**Contact SAMSUNG WORLDWIDE**

If you have any questions or comments relating to Samsung products, please contact the SAMSUNG customer care centre.

Country	Customer Care Centre ☎	Web Site
AUSTRIA	0810 - SAMSUNG (7267864, € 0.07/min)	www.samsung.com/at
BELGIUM	02 201 2418	www.samsung.com/be
CZECH REPUBLIC	800 - SAMSUNG (800-726786) Distributor pro Českou republiku: Samsung Zrt., česká organizační složka, Oasis Florenc, Sokolovská394/17, 180 00, Praha 8	www.samsung.com/cz
DENMARK	8 - SAMSUNG (7267864)	www.samsung.com/dk
EIRE	0818 717 100	www.samsung.com/ie
FINLAND	30 - 6227 515	www.samsung.com/fi
FRANCE	3260 'dites' SAMSUNG (€ 0,15/Min) 0825 08 65 65 (€ 0.15/Min)	www.samsung.com/fr
GERMANY	01805 - SAMSUNG (7267864, € 0.14/Min)	www.samsung.de
HUNGARY	06 - 80 - SAMSUNG (7267864)	www.samsung.com/hu
ITALIA	800 - SAMSUNG (7267864)	www.samsung.com/it
LUXEMBURG	02 261 03 710	www.samsung.com/lu
NETHERLANDS	0900 - SAMSUNG (7267864, € 0.10/Min)	www.samsung.com/nl
NORWAY	3 - SAMSUNG (7267864)	www.samsung.com/no
POLAND	0 - 801 - 1SAMSUNG (172678) 022 - 607 - 93 - 33	www.samsung.com/pl
PORTUGAL	808 20 - SAMSUNG (7267864)	www.samsung.com/pt
SLOVAKIA	0800 - SAMSUNG (7267864)	www.samsung.com/sk
SPAIN	902 - 1 - SAMSUNG (902 172 678)	www.samsung.com/es
SWEDEN	075 - SAMSUNG (726 78 64)	www.samsung.com/se
SWITZERLAND	0848 - SAMSUNG (7267864, CHF 0.08/min)	www.samsung.com/ch
U.K	0845 SAMSUNG (7267864)	www.samsung.com/uk
TURKEY	444 77 11	www.samsung.com/tr
ESTONIA	800-7267	www.samsung.ee
LATVIA	8000-7267	www.samsung.com/lv
LITHUANIA	8-800-77777	www.samsung.lt
KAZAHSTAN	8-10-800-500-55-500	www.samsung.com/kz_ru
KYRGYZSTAN	00-800-500-55-500	-
RUSSIA	8-800-555-55-55	www.samsung.ru
TADJIKISTAN	8-10-800-500-55-500	-
UKRAINE	8-800-502-0000	www.samsung.ua
UZBEKISTAN	8-10-800-500-55-500	www.samsung.com/kz_ru



BN68-01464G-00

SERIES
5

LCD TV

user manual

imagine the possibilities

Thank you for purchasing this Samsung product.
To receive more complete service, please register
your product at

www.samsung.com/global/register

Model _____ Serial No. _____



Contact SAMSUNG WORLDWIDE

If you have any questions or comments relating to Samsung products, please contact the SAMSUNG customer care centre.(See back cover for more information)

Precautions When Displaying a Still Image

A still image may cause permanent damage to the TV screen.

- Do not display a still image on the LCD panel for more than 2 hours as it can cause screen image retention.

This image retention is also known as "screen burn".

To avoid such image retention, reduce the degree of brightness and contrast of the screen when displaying a still image.

-  Watching the LCD TV in 4:3 format for a long period of time may leave traces of borders displayed on the left, right and center of the screen caused by the difference of light emission on the screen. Playing a DVD or a game console may cause a similar effect to the screen. Damages caused by the above effect are not covered by the Warranty.
- Displaying still images from Video games and PC for longer than a certain period of time may produce partial after-images.
To prevent this effect, reduce the 'brightness' and 'contrast' when displaying still images.

Contents

CONNECTING AND PREPARING YOUR TV

◆ List of Parts	2
◆ Installing the Wall Mount Kit	2
◆ Viewing the Control Panel	3
◆ Viewing the Connection Panel	4
◆ Viewing the Remote Control	7
◆ Installing Batteries in the Remote Control	8
◆ Switching On and Off	8
◆ Placing Your Television in Standby Mode	8
◆ Viewing the Menus	9
◆ Using the TOOLS Button	9
◆ Plug & Play	10

SETTING THE CHANNELS

◆ Storing Channels Automatically	11
◆ Storing Channels Manually	12
◆ Adding / Locking Channels	13
◆ Sorting the Stored Channels	14
◆ Assigning Channels Names	14
◆ Fine Tuning Channel Reception	15
◆ LNA (Low Noise Amplifier)	15

SETTING THE PICTURE

◆ Changing the Picture Standard	16
◆ Adjusting the Custom Picture	17
◆ Configuring Detailed Settings on the Picture ...	17
◆ Resetting the Picture Settings to the Factory Defaults	18
◆ Changing the Picture Options	19

SETTING THE SOUND

◆ Sound Features	21
◆ Selecting the Sound Mode	22
◆ Connecting Headphones (Sold separately)	22

SETTING THE TIME

◆ Setting and Displaying the Current Time	23
◆ Setting the Sleep Timer	23
◆ Switching the Television On and Off Automatically	24

FUNCTION DESCRIPTION

◆ Choosing Your Language	24
◆ Melody / Entertainment / Energy Saving	25
◆ Selecting the Source	26
◆ Editing the Input Source Names	27

USING THE DTV FEATURE

◆ Previewing the DTV Menu System	28
◆ Updating the Channel List Automatically	29
◆ Updating the Channel List Manually	29
◆ Editing Your Favourite Channels	30
◆ Selecting Channel List	32
◆ Displaying Programme Information	32
◆ Viewing the EPG (Electronic Programme Guide) Information	33
◆ Using the Scheduled List	34
◆ Setting the Default Guide	34
◆ Viewing All Channels and Favourite Channels	35
◆ Adjusting the Menu Transparency	35
◆ Setting up the Parental Lock	36
◆ Setting the Subtitle	37
◆ Setting the Subtitle Mode	37
◆ Selecting the Audio Format	37
◆ Selecting the Audio Description	38
◆ Selecting the Digital Text (UK only)	38
◆ Selecting the Time Zone (Spain only)	39
◆ Viewing Product Information	39
◆ Checking the Signal Information	40
◆ Upgrading the Software	40
◆ Viewing Common Interface	41
◆ Selecting the CI (Common Interface) Menu	41
◆ Resetting	42
◆ Selecting the Preferred Language (Subtitle, Audio or Teletext)	42
◆ Preference	43

SETTING THE PC

◆ Setting up Your PC Software (Based on Windows XP)	44
◆ Display Modes	44
◆ Setting up the TV with your PC	45

ABOUT ANYNET⁺

◆ What is Anynet ⁺ ?	46
◆ Connecting Anynet ⁺ Devices	46
◆ Setting Up Anynet ⁺	47
◆ Scanning and Switching between Anynet ⁺ Devices	48
◆ Recording	50
◆ Listening through a Receiver	50
◆ Check Points before Requesting Service	51

RECOMMENDATIONS FOR USE

◆ Teletext Feature	52
◆ Wall-Mount Adjustment	54
◆ Using the Anti-Theft Kensington Lock	55
◆ Securing the TV to the Wall	56
◆ Troubleshooting: Before Contacting Service Personnel	57
◆ Technical and Environmental Specifications ...	58



Symbol



Press



Note

One-Touch Button

List of Parts

Please make sure the following items are included with your LCD TV.
If any items are missing, contact your dealer.



Remote Control & Batteries
(AAA x 2)



Power Cord

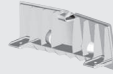

Cover-Bottom



Cleaning Cloth

♦ Owner's Instructions

♦ Warranty card

♦ Safety Guide

♦ Registration Cards

➤ Warranty card / Safety Guide / Registration Cards (Not available in all locations)

Installing the Wall Mount Kit

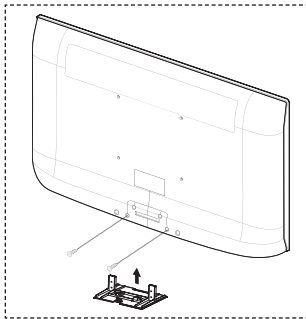

Wall mount items (sold separately) allow you to mount the TV on the wall.

For detailed information on installing the wall mount, see the instructions provided with the Wall Mount items. Contact a technician for assistance when installing the wall mounted bracket. Samsung Electronics is not responsible for any damage to the product or injury to yourself or others if you elect to install the TV on your own.



Do not install your Wall Mount Kit while your TV is turned on. It may result in personal injury due to electric shock.

➤ Remove the stand and cover the bottom hole with a cap and fasten with two screws.

Viewing the Control Panel

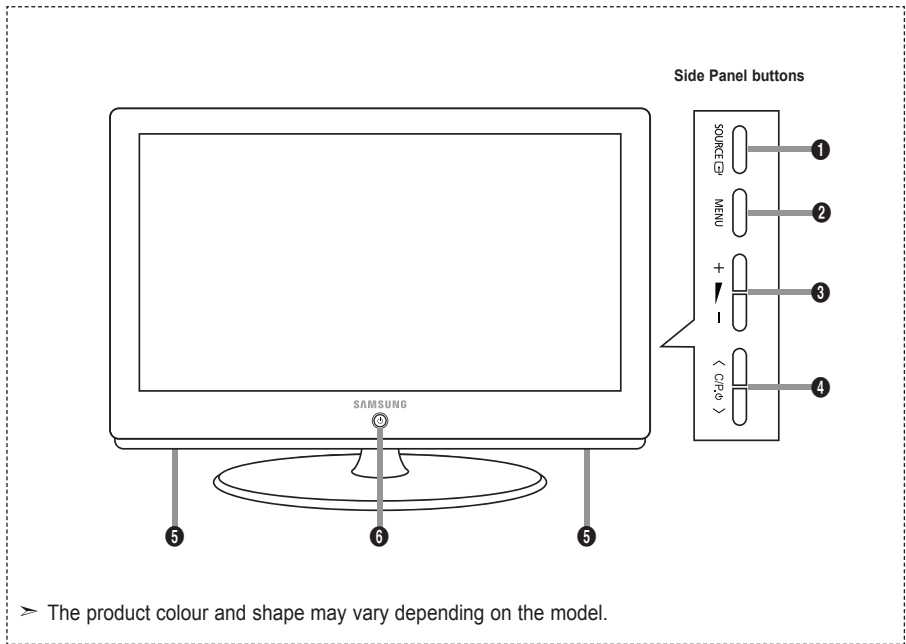

➤ The product colour and shape may vary depending on the model.



1 SOURCE

Toggles between all the available input sources (TV, Ext.1, Ext.2, AV, S-Video, Component, PC, HDMI1, HDMI2, HDMI3, DTV). In the on-screen menu, use this button as you use the **ENTER**  button on the remote control.



2 MENU

Press to see an on-screen menu of your TV's features.

3 + -

Press to decrease or increase the volume. In the on-screen menu, use the +  - buttons as you use the  and  buttons on the remote control.

4 < C/P.Ⓟ >

Press to change channels. In the on-screen menu, use the < C/P.Ⓟ > buttons as you use the  and  buttons on the remote control. (Without the Remote Control, you can turn on the TV by using the Channel buttons.)

5 Speakers

6 (Power)

Press to turn the TV on and off.

Remote Control Sensor

Aim the remote control towards this spot on the TV.

Power Indicator

Blinks and turns off when the power is on and lights up in stand-by mode.

Viewing the Connection Panel

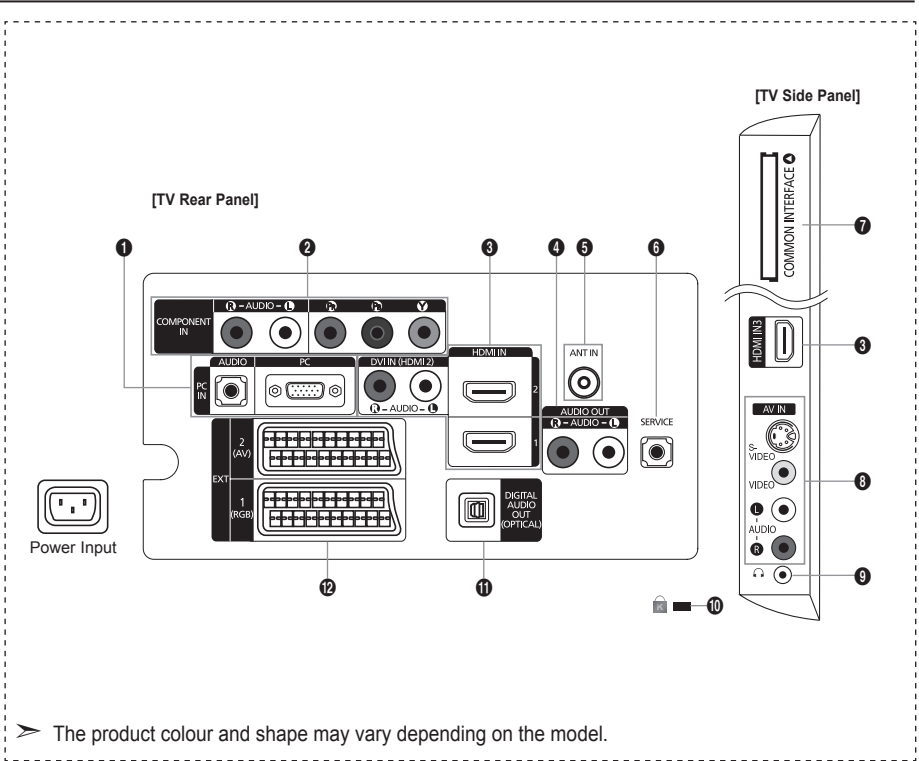

➤ The product colour and shape may vary depending on the model.

- Whenever you connect an external device to your TV, make sure that power on the unit is turned off.
- When connecting an external device, match the colour of the connection terminal to the cable.

1 PC IN [PC] / [AUDIO]

- Connect to the video and audio output jack on your PC.

2 COMPONENT IN

- Connect component video cables (optional) to component connector ("P_R", "P_B", "Y") on the rear of your set and the other ends to corresponding component video out connectors on the DTV or DVD.
- If you wish to connect both the Set-Top Box and DTV (or DVD), you should connect the Set-Top Box to the DTV (or DVD) and connect the DTV (or DVD) to component connector ("P_R", "P_B", "Y") on your set.
- The P_R, P_B and Y connectors on your component devices (DTV or DVD) are sometimes labeled Y, B-Y and R-Y or Y, Cb and Cr.
- Connect RCA audio cables (optional) to "R - AUDIO - L" on the rear of your set and the other ends to corresponding audio out connectors on the DTV or DVD.

3 HDMI IN 1, HDMI IN 2, HDMI IN 3

- Supports connections between HDMI-connection-enabled AV devices (Set-Top Boxes, DVD players)
- No additional Audio connection is needed for an HDMI to HDMI connection.
- When using an HDMI/DVI cable connection, you must use the HDMI IN 2 jack.

➤ What is HDMI?

- "High Definition Multimedia interface" allows the transmission of high definition digital video data and multiple channels of digital audio.
- The HDMI/DVI terminal supports DVI connection to an extended device with the appropriate cable (not supplied). The difference between HDMI and DVI is that the HDMI device is smaller in size, has the HDCP (High Bandwidth Digital Copy Protection) coding feature installed, and supports multi - channel digital audio.

DVI IN(HDMI2) [R-AUDIO-L]

- DVI audio outputs for external devices.
- Supported modes for HDMI/DVI and Component

	480i	480p	576i	576p	720p	1080i	1080p
HDMI/DVI 50Hz	X	X	X	O	O	O	O
HDMI/DVI 60Hz	X	O	X	X	O	O	O
Component	O	O	O	O	O	O	O

4 AUDIO OUT [R-AUDIO-L]

- Connect RCA audio cables to AUDIO OUT [R-AUDIO-L] on the rear of your set and the other ends to corresponding audio in connectors on the Amplifier or DVD Home Theatre.

5 ANT IN

To view television channels correctly, a signal must be received by the set from one of the following sources:

- An outdoor aerial / A cable television network / A satellite network

6 SERVICE

- Connector for SERVICE only.
- Connect this to the jack on the optional wall mount bracket. This will allow you to adjust the TV viewing angle using your remote control.

7 COMMON INTERFACE Slot

- When CI Card isn't inserted in some channels, "Scrambled Signal" is displayed on the screen.
- The pairing information containing a telephone number, CI Card ID, Host ID and other information will be displayed in about 2~3 minutes. If an error message is displayed, please contact your service provider.
- When the channel information configuration has finished, the message "Updating Completed" is displayed, indicating that the channel list is now updated.

- You must obtain a CI Card from a local cable service provider. Remove the CI Card by carefully pulling it out with your hands since dropping the CI Card may cause damage to it.
- Insert the CI-Card in the direction marked on it.
- The place of the COMMON INTERFACE Slot may be different depending on its model.

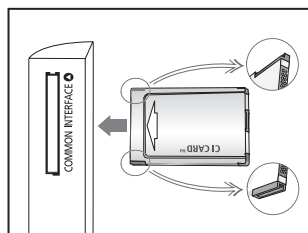

8 S-VIDEO or VIDEO / R-AUDIO-L

- Connect RCA or S-VIDEO cable to an appropriate external A/V device such as VCR, DVD or Camcorder.
- Connect RCA audio cables to "R-AUDIO-L" on your set and the other ends to corresponding audio out connectors on the A/V device.

9 HEADPHONES JACK

- Headphone may be connected to the headphone output on your set. While the head phone is connected, the sound from the built-in speakers will be disabled.

10 Kensington Lock (depending on the model)

- The Kensington Lock (optional) is a device used to physically fix the system when used in a public place.
- If you want to use a locking device, contact the dealer where you purchased the TV.
- The location of the kensington lock may be different depending on its model.

11 DIGITAL AUDIO OUT (OPTICAL)

- Connect to a Digital Audio Component.

➤ When the HDMI IN jacks are connected, the DIGITAL AUDIO OUT (OPTICAL) jack on the TV outputs 2 channel audio only. If you want to hear 5.1 channel audio, connect the Optical jack on the DVD player or Cable/Satellite Box directly to an Amplifier or Home Theater, not the TV.

12 EXT 1, EXT 2

Connector	Input			Output
	Video	Audio (L/R)	RGB	Video + Audio (L/R)
EXT 1	O	O	O	Only TV or DTV output is available.
EXT 2	O	O		Output you can choose.

-Inputs or outputs for external devices, such as VCR, DVD, video game device or video disc players.

Viewing the Remote Control

- 1 Television Standby button
- 2 Selects the TV and DTV mode directly
- 3 Number buttons for direct channel access
- 4 One/Two-digit channel selection
- 5 ⊕: Volume increase
⊖: Volume decrease
- 6 Temporary sound switch-off
- 7 Electronic Program Guide (EPG) display
- 8 Use to quickly select frequently used functions.
- 9 Use to see information on the current broadcast
- 10 Colour buttons : Use these buttons in the Channel list, etc.
- 12 Press to select the optional display and sound modes for sports, cinema and games.
- 13 Use these buttons in the DMA, and Anynet+ (■): This remote can be used to control recording on Samsung recorders with the Anynet+ feature)
- 14 Available source selection
- 15 Previous channel
- 16 P◁: Next channel
▷P: Previous channel
- 17 Displays the main on-screen menu
- 18 Displays the Channel List on screen
- 19 Returns to the previous menu
- 20 Control the cursor in the menu

- 21 Exit the on-screen menu
- 22 Use this when connecting a SAMSUNG DMA (Digital Media Adapter) device through an HDMI interface and switching to DMA mode. (The DMA button is optional.)
For more information on the operating procedures, refer to the user manual of the DMA. This button is available when "Anynet+ (HDMI-CEC)" is "On" (see page 47)
- 23 Picture size selection
- 24 Digital subtitle display
- 25 Selects the HDMI mode directly.

Teletext Functions

- 2 Exit from the teletext display
- 7 Teletext store
- 8 Teletext size selection
- 9 Teletext reveal
- 10 Fastext topic selection
- 11 Alternately select Teletext, Double, or Mix.
- 14 Teletext mode selection (LIST/FLOF)
- 15 Teletext sub page
- 16 P◁: Teletext next page
▷P: Teletext previous page
- 17 Teletext index
- 19 Teletext hold
- 21 Teletext cancel

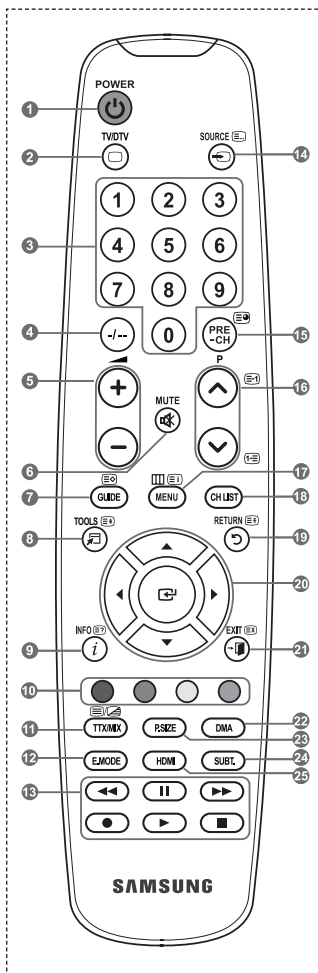

➤ The performance of the remote control may be affected by bright light.

Installing Batteries in the Remote Control

1. Lift the cover at the back of the remote control upward as shown in the figure.
2. Install two AAA size batteries.
 - Make sure to match the "+" and "-" ends of the batteries with the diagram inside the compartment.
3. Replace the cover.
 - Remove the batteries and store them in a cool, dry place if you won't be using the remote control for a long time.

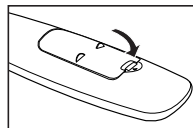
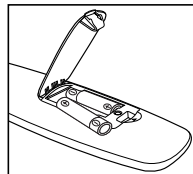
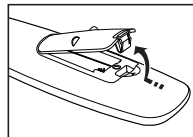

- If the remote control doesn't work, check the following:
 1. Is the TV power on?
 2. Are the plus and minus ends of the batteries reversed?
 3. Are the batteries drained?
 4. Is there a power outage, or is the power cord unplugged?
 5. Is there a special fluorescent light or neon sign nearby?

Switching On and Off

The mains lead is attached to the rear of your set.

1. Plug the mains lead into an appropriate socket.
 - The standby indicator lights up on your set.
2. Press the \odot button on your set.
 - You also can press the **POWER** \odot button or the **TV/DTV** button on the remote control to turn the TV on.
 - The channel that you were watching last is reselected automatically.
3. Press the numeric button (0~9) or channel up/down (\odot/\odot) button on the remote control or **< C.P. >** button on your set.
 - When you switch the set on for the very first time, you will be asked to choose language in which the menus are to be displayed.
4. To switch your set off, press the **POWER** \odot button again.

Placing Your Television in Standby Mode

Your set can be placed in standby mode in order to reduce the power consumption. The standby mode can be useful when you wish to interrupt viewing temporarily (during a meal, for example).

1. Press the **POWER** \odot button on the remote control.
 - The screen is turned off and a red standby indicator appears on your set.
2. To switch your set back on, simply press the **POWER** \odot , numeric buttons (0~9), **TV/DTV** button or channel up/down (\odot/\odot) button again.
 - Do not leave your set in standby mode for long periods of time (when you are away on holiday, for example).
It is best to unplug the set from the mains and aerial.

Viewing the Menu

1. With the power on, press the **MENU** button.
The main menu appears on the screen. The menu's left side has icons: Picture, Sound, Channel, Setup, Input, Digital Menu.
2. Press the **▲** or **▼** button to select one of the icons. Then press the **ENTER** button to access the icon's sub-menu.
3. Press the **EXIT** button to exit.
 - The on-screen menu disappear from the screen after about one minute.

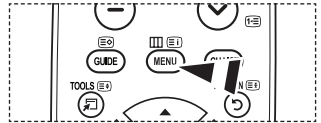
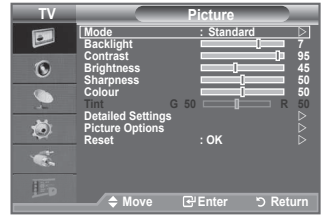

Using the TOOLS Button

You can use the **TOOLS** button to select your frequently used functions quickly and easily. The "Tools" menu change depending on which external input mode you are viewing.

1. Press the **TOOLS** button.
The "Tools" menu will appear.
2. Press the **▲** or **▼** button to select a menu.
3. Press the **▲/▼/◀/▶/ENTER** buttons to display, change, or use the selected items. For a more detailed description of each function, refer to the corresponding page.

- Anynet+ (HDMI-CEC), see page 47
- Picture Mode, see page 16
- Sound Mode, see page 21
- Sleep Timer, see page 23
- SRS TS XT, see page 21
- Energy Saving, see page 26
- Dual I-II, see page 22
- Auto Adjustment, see page 45

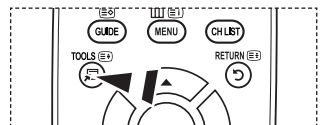
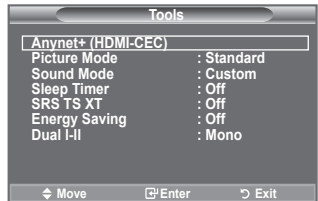

Plug & Play

When the TV is initially powered on, several basic settings proceed automatically and subsequently. The following settings are available.



- Any functions related to Digital TV (DVB) will only work in countries or areas where DVB-T (MPEG2) digital terrestrial signals are broadcasted. Please confirm with your local dealer if you can receive DVB-T signals. Although this TV set follows the DVB-T specification, maintaining compatibility with the future coming DVB-T digital terrestrial broadcasts is not guaranteed. Several functions may not be available in some countries.
1. Press the **POWER** button on the remote control.
The message "Start Plug & Play." is displayed with "OK" selected.
 2. Select the appropriate language by pressing the **▲** or **▼** button.
Press the **ENTER** button to confirm your choice.
 3. Press the **◀** or **▶** button to select "Store Demo" or "Home Use", then the **ENTER** button.
 - We recommend setting the TV to "Home Use" mode for the best picture in your home environment.
 - "Store Demo" mode is only intended for use in retail environments.
 - If the unit is accidentally set to "Store Demo" mode and you want to return to "Home Use" (Standard): Press the Volume button on the TV. When the volume OSD is displayed, press and hold the **MENU** button on the TV for 5 seconds.
 4. The message "Check antenna input." is displayed with "OK" selected.
Press the **ENTER** button.
 - Please check that the antenna cable is connected correctly.
 5. Select the appropriate country by pressing the **▲** or **▼** button.
Press the **ENTER** button to confirm your choice.
 6. The message "Some DTV functions may not be available. Digital Scan?" is displayed.
Press the **◀** or **▶** button to select "Yes" or "No", then press the **ENTER** button.

- ♦ **Yes:** First an Analogue TV search is performed and then a Digital TV ch. auto search is performed.
 - ♦ **No:** Only an Analogue TV search is performed.

 - This function is supported for all countries except for the following countries: France, Germany, Italy, Netherlands, Spain, Switzerland, United Kingdom, Austria.
 7. The "Auto Store" menu is displayed with the "Start" selected. Press the **ENTER** button.
 - The channel search will start and end automatically.
 - The DTV channel scan menu appears and the DTV channel is automatically updated.
 - If the DTV channel is updated, the Source in the source list of the Input menu is automatically changed to DTV.
 - After all the available channels are stored, the "Clock Set" menu appears.
 - Press the **ENTER** button at any time to interrupt the memorization process.
 - For detailed descriptions about DTV channel update, refer to page 29 of this manual.
 - After all the available digital channels are stored, the screen to select a time zone is displayed depending on the country.
 8. Press the **ENTER** button.
Select the "Month", "Day", "Year", "Hour", or "Min" by pressing the **◀** or **▶** button.
Set the "Month", "Day", "Year", "Hour", or "Min" by pressing the **▲** or **▼** button.
 - You can also set the "Month", "Day", "Year", "Hour" and "Min" by pressing the number buttons on the remote control.

- Press the **ENTER** button to confirm your setting. The message "Enjoy your viewing" is displayed. When you have finished, press the **ENTER** button.
 - Even if the **ENTER** button is not pressed, the message will automatically disappear after several seconds.

- ♦ **Language:** Select your language.
- ♦ **Country:** Select your country.
- ♦ **Auto Store:** Automatically scans for and stores channels available in the local area.
- ♦ **Clock Set:** Sets the current time for the TV clock.

If you want to reset this feature...

- Press the **MENU** button to display the menu. Press the **▲** or **▼** button to select "Setup" then press the **ENTER** button.
- Press the **ENTER** button again, to select "Plug & Play". For further details on setting up options, refer to the page 10.
 - The "Plug & Play" feature is only available in the TV mode.

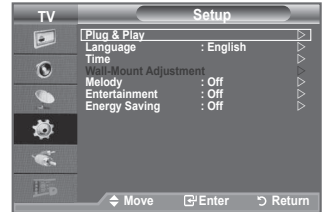

Storing Channels Automatically

You can scan for the frequency ranges available to you (and availability depends on your country). Automatically allocated programme numbers may not correspond to actual or desired programme numbers. However, you can sort numbers manually and clear any channels you do not wish to watch.

- Press the **MENU** button to display the menu. Press the **▲** or **▼** button to select "Channel", then press the **ENTER** button.
- Press the **ENTER** button to select "Country".
- Select the appropriate country by pressing the **▲** or **▼** button. Press the **ENTER** button to confirm your choice.
 - Even though you have changed the country setting in this menu, the country setting for DTV is not changed. (Refer to page 29)
- Press the **▲** or **▼** button to select "Auto Store", then press the **ENTER** button.
- Press the **ENTER** button.
 - The TV will begin memorizing all of the available channels.
 - Press the **ENTER** button at any time to interrupt the memorization process and return to the "Channel" menu.
- After all the available channels are stored, the "Sort" menu appears. (refer to page 14)



Storing Channels Manually

➤ Not available in DTV or external input mode.

You can store television channels, including those received via cable networks.

When storing channels manually, you can choose:

- ◆ Whether or not to store each of the channels found.
- ◆ The programme number of each stored channel which you wish to identify.

1. Press the **MENU** button to display the menu.
Press the **▲** or **▼** button to select "Channel", then press the **ENTER** button.
2. Press the **▲** or **▼** button to select "Manual Store", then press the **ENTER** button.
3. Select the required option by pressing the **▲** or **▼** button, then press the **ENTER** button.
4. When you are satisfied with your setting, press the **ENTER** button.
5. Press the **EXIT** button to exit.

- ◆ **Programme** (Programme number to be assigned to a channel)
 - Press the **▲** or **▼** button until you find the correct number.
 - You can also select the channel number directly by pressing the numeric buttons (0~9).
- ◆ **Colour System: Auto/PAL/SECAM/NTSC4.43**
 - Press the **▲** or **▼** button to select the required colour standard.
- ◆ **Sound System: BG/DK/I/L**
 - Press the **▲** or **▼** button to select the required sound standard.
- ◆ **Channel** (When you know the number of the channel to be stored)
 - Press the **▲** or **▼** button to select **C** (Air channel) or **S** (Cable channel).
 - Press the **▶** button, then press the **▲** or **▼** button to select the required number.
 - You can also select the channel number directly by pressing the numeric buttons (0~9).
 - If there is abnormal sound or no sound, re-select the sound standard required.
- ◆ **Search** (When you do not know the channel numbers)
 - Press the **▲** or **▼** button to start the search.
 - The tuner scans the frequency range until the first channel or the channel that you selected is received on the screen.

- ◆ **Store** (When you store the channel and associated programme number)
 - Set to "OK" by pressing the **ENTER** button.

➤ **Channel mode**

- **P** (Programme mode): When completing tuning, the broadcasting stations in your area have been assigned to position numbers from P00 to P99. You can select a channel by entering the position number in this mode.
- **C** (Air channel mode): You can select a channel by entering the assigned number to each air broadcasting station in this mode.
- **S** (Cable channel mode): You can select a channel by entering the assigned number for each cable channel in this mode.

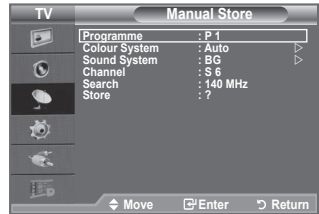

Adding / Locking Channels

➤ Not available in DTV or external input mode.

Using the Channel Manager, you can conveniently lock or add channels.

1. Press the **MENU** button to display the menu.
Press the **▲** or **▼** button to select "Channel", then press the **ENTER** button.
2. Press the **▲** or **▼** button to select "Channel Manager", then press the **ENTER** button.



◆ Adding channels

Using the Channel List, you can add channels.

3. Select "Channel List" by pressing the **ENTER** button.
4. Move to the **(+)** field by pressing the **▲**, **▼**, **◀** or **▶** button, select a channel to be added, and press the **ENTER** button to add the channel.
 - If you press the **ENTER** button again, the (✓) symbol next to the channel disappears and the channel is not added.
 - "🔒" is active when "Child Lock" is selected to "On".



◆ Locking channels

This feature allows you to prevent unauthorized users, such as children, from watching unsuitable programmes by muting out video and audio.

5. Press the **▲** or **▼** button to select "Child Lock", then press the **ENTER** button.
6. Select "On" by pressing the **▲** or **▼** button, then press the **ENTER** button.
7. Press the **▲** or **▼** button to select "Channel List", then press the **ENTER** button.
8. Move to the "🔒" field by pressing the **▲**, **▼**, **◀** or **▶** button, select a channel to be locked, and press the **ENTER** button.
 - If you press the **ENTER** button again, the (✓) symbol next to the channel disappears and the channel lock is cancelled.
 - A blue screen is displayed when "Child Lock" is activated.
9. Press the **EXIT** button to exit.
 - Select "On" or "Off" in "Child Lock" to easily turn the channels which selected on "🔒" to be active or inactive.

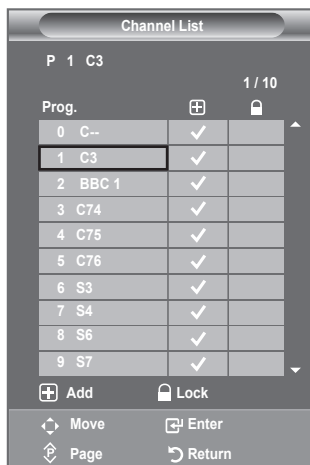

 You can select these options by simply pressing the **CH LIST** button on the remote control.

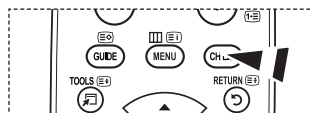

Sorting the Stored Channels

This operation allows you to change the programme numbers of the stored channels.

This operation may be necessary after using the auto store.

➤ Not available in DTV or external input mode.

1. Press the **MENU** button to display the menu. Press the **▲** or **▼** button to select "Channel", then press the **ENTER** button.
2. Press the **▲** or **▼** button to select "Sort", then press the **ENTER** button.
3. Select the channel number that you wish to change by pressing the **▲** or **▼** button repeatedly. Press the **ENTER** button.
 - The selected channel number and name are moved to right side.
4. Select the number of the programme to which the channel is to be moved by pressing the **▲** or **▼** button.
5. Press the **ENTER** button.
 - The channel is moved to its new position and all other channels are shifted accordingly.
6. Repeat steps 3 to 5 for another channel to be sorted.
7. Press the **EXIT** button to exit.

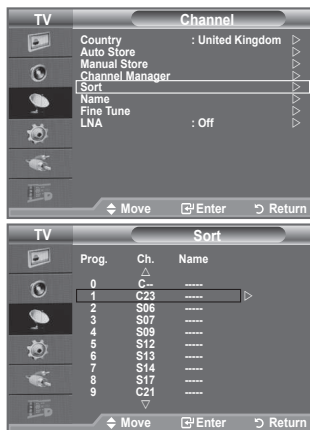

Assigning Channels Names

Channel names will be assigned automatically when channel information is broadcast. These names can be changed, allowing you to assign new names.

➤ Not available in DTV or external input mode.

1. Press the **MENU** button to display the menu. Press the **▲** or **▼** button to select "Channel", then press the **ENTER** button.
2. Press the **▲** or **▼** button to select "Name", then press the **ENTER** button.
3. If necessary, select the channel to be assigned to a new name by pressing the **▲** or **▼** button. Press the **ENTER** button.
 - The selection bar is displayed around the name box.

4.	To...	Then...
	Select a letter, number or symbol	Press the ▲ or ▼ button
	Move on the next letter	Press the ▶ button
	Move back the previous letter	Press the ◀ button
	Confirm the name	Press the ENTER button

➤ The following characters are available: Letters of the alphabet (A~Z) / Numbers (0~9) / Special characters (+, -, *, /, space)

5. Repeat steps 3 to 4 for each channel to be assigned to a new name.
6. Press the **EXIT** button to exit.



Fine Tuning Channel Reception

Use fine tuning to manually adjust a particular channel for optimal reception.

- Not available in DTV or external input mode.
1. Use the number buttons to directly select the channel that you want to fine tune.
 2. Press the **MENU** button to display the menu. Press the **▲** or **▼** button to select "Channel", then press the **ENTER** button.
 3. Press the **▲** or **▼** button to select "Fine Tune", then press the **ENTER** button.
 4. Press the **◀** or **▶** button to adjust the fine tuning. Press the **ENTER** button.
 5. Press the **EXIT** button to exit.
 - Fine tuned channels that have been saved are marked with an asterisk "*" on the right-hand side of the channel number in the channel banner. And the channel number turns red.
 - To reset the fine-tuning, select "Reset" by pressing the **▲** or **▼** button and then press the **ENTER** button.



LNA (Low Noise Amplifier)

If the TV is operating in a weak-signal area, the LNA function can improve the reception (a low-noise preamplifier boosts the incoming signal).

- Not available in DTV or external input mode.
1. Press the **MENU** button to display the menu. Press the **▲** or **▼** button to select "Channel", then press the **ENTER** button.
 2. Press the **▲** or **▼** button to select "LNA", then press the **ENTER** button.
 3. Press the **▲** or **▼** button to select "Off" or "On". Press the **ENTER** button.
 4. Press the **EXIT** button to exit.

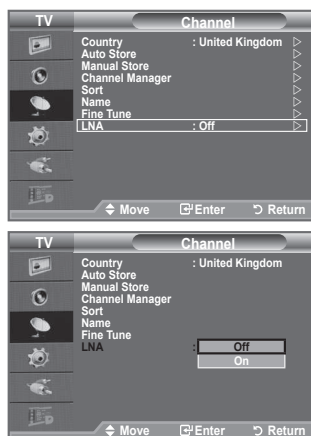

Changing the Picture Standard

You can select the type of picture which best corresponds to your viewing requirements.

1. Press the **MENU** button to display the menu.
Press the **ENTER** button, to select "Picture".
2. Press the **ENTER** button again, to select "Mode".
3. Press the **▲** or **▼** button to select the desired picture effect.
Press the **ENTER** button.
4. Press the **EXIT** button to exit.

- ◆ **Dynamic:** Selects the picture for high-definition in a bright room.
- ◆ **Standard:** Selects the picture for optimum display in a normal environment.
- ◆ **Movie:** Selects the picture for comfortable display in a dark room.

> The Picture mode must be adjusted separately for each input source.

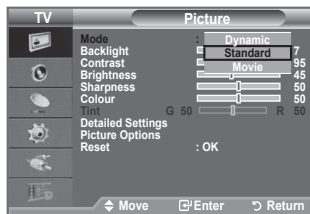
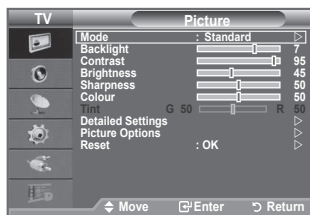

Easy Setting

1. Press the **TOOLS** button on the remote control.
2. Press the **▲** or **▼** button to select "Picture Mode".
3. Press the **◀** or **▶** button to select the required option.
4. Press the **EXIT** or **TOOLS** button to exit.

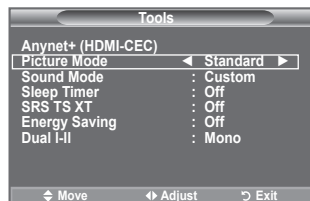

Adjusting the Custom Picture

Your set has several settings which allow you to control picture quality.

- To select the desired picture effect, follow the "Changing the Picture Standard" instructions number 1 to 3. (On page 16)
- Press the ▲ or ▼ button to select a particular item. Press the **ENTER** button.
- Press the ◀ or ▶ button to decrease or increase the value of a particular item. Press the **ENTER** button.
- Press the **EXIT** button to exit.

- ◆ **Backlight:** Adjusts the screen brightness by adjusting the LCD backlight brightness. (0~10)
- ◆ **Contrast:** Adjusts the lightness and darkness between objects and the background.
- ◆ **Brightness:** Adjusts the brightness of the whole screen.
- ◆ **Sharpness:** Adjusts the outline of objects to either sharpen them or make them more dull.
- ◆ **Colour:** Adjusts the colours, making them lighter or darker.
- ◆ **Tint:** Adjusts the colour of objects, making them more red or green for a more natural look.

- The adjusted values are stored according to the selected Picture mode.
- In PC mode, you can only make changes to "Backlight", "Contrast" and "Brightness".
- In Analogue TV, Ext., AV, S-Video modes of the PAL system, you cannot use the "Tint" Function.
- You can return to the factory defaults picture settings by selecting the "Reset". (Refer to "Resetting the Picture Settings to the Factory Defaults" on page 18)
- The energy consumed during use can be significantly reduced if the level of brightness of the picture is reduced, and then this will reduce the overall running cost.

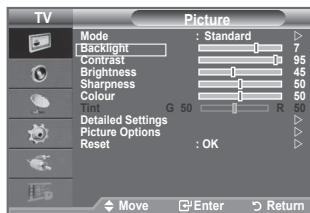

Configuring Detailed Settings on the Picture

You can set detailed picture settings.

- Press the **MENU** button to display the menu. Press the **ENTER** button, to select "Picture".
- Press the **ENTER** button to select "Mode". Press the ▲ or ▼ button to select "Standard" or "Movie", then press the **ENTER** button.
- Press the ▲ or ▼ button to select "Detailed Settings", then press the **ENTER** button.
- Select the required option by pressing the ▲ or ▼ button, then press the **ENTER** button.
- When you are satisfied with your setting, press the **ENTER** button.
- Press the **EXIT** button to exit.
 - "Detailed Settings" is available in "Standard" or "Movie" mode.
 - In PC mode, you can only make changes to "Dynamic Contrast", "Gamma" and "White Balance" from among the "Detailed Settings" items.

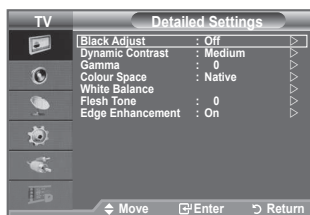
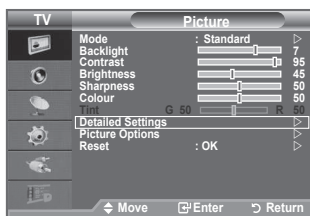

- ◆ **Black Adjust: Off/Low/Medium/High**
You can directly select the black level on the screen to adjust the screen depth.
- ◆ **Dynamic Contrast: Off/Low/Medium/High**
You can adjust the screen contrast so that the optimal contrast is provided.
- ◆ **Gamma: -3 ~ +3**
You can adjust the Primary Colour (Red, Green, Blue) Intensity.
Press the ◀ or ▶ button until you reach the optimal setting.
- ◆ **Colour Space: Auto/Native/Custom**
Colour space is a Colour matrix composed of red, green and blue colours.
Select your favourite Colour space to experience the most natural Colour.

- ◆ **Auto:** Auto Color Space automatically adjusts to the most natural color tone based on program sources.
- ◆ **Native:** Native Color Space offers deep and rich color tone.
- ◆ **Custom:** Adjusts the color range to suit your preference.

➤ Customizing the Colour Space

Colour: Red/Green/Blue/Yellow/Cyan/Magenta

Adjusts the Colour range to suit your preference.

"Colour" is available when "Colour Space" is set to "Custom".

Press the ▲ or ▼ button to select "Red", "Green", "Blue", "Yellow", "Cyan" or "Magenta".

Press the ENTER button.

Red/Green/Blue: In "Colour", you can adjust the RGB values for the selected colour.

Press the ▲ or ▼ button to select "Red", "Green" or "Blue" to change it. Press the ENTER button.

Press the ◀ or ▶ button to decrease or increase the value of a particular item.

Press the ENTER button.

Reset: Resets the colour space to the default values.

- ◆ **White Balance: R-Offset/G-Offset/B-Offset/R-Gain/G-Gain/B-Gain/Reset**

You can adjust the colour temperature for more natural picture colours.

R-Offset/G-Offset/B-Offset/R-Gain/G-Gain/B-Gain: Changing the adjustment value will refresh the adjusted screen.

Select the required option by pressing the ▲ or ▼ button, then press the ENTER button.

Press the ◀ or ▶ button until you reach the optimal setting.

Reset: The previously adjusted white balance will be reset to the factory defaults.

- ◆ **Flesh Tone: -15 ~ +15**

You can emphasize the pink 'flesh tone' in the picture.

Press the ◀ or ▶ button until you reach the optimal setting.

➤ Changing the adjustment value will refresh the adjusted screen.

- ◆ **Edge Enhancement: Off/On**

You can emphasize object boundaries in the picture.

Resetting the Picture Settings to the Factory Defaults

You can return to the factory defaults picture settings.

1. To select the desired picture effect, follow the "Changing the Picture Standard" instructions number 1 to 3 on page 16.
 2. Press the ▲ or ▼ button to select "Reset", then press the ENTER button.
 3. Press the ▲ or ▼ button to select "OK" or "Cancel".
Press the ENTER button.
 4. Press the EXIT button to exit.
- The "Reset" will be set for each Picture mode.

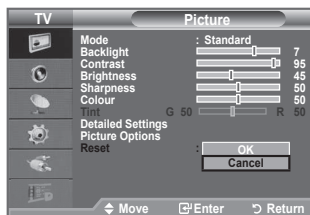

Changing the Picture Options

1. Press the **MENU** button to display the menu. Press the **ENTER** button, to select "Picture".
2. Press the **▲** or **▼** button to select "Picture Options", then press the **ENTER** button.
3. Select the required option by pressing the **▲** or **▼** button, then press the **ENTER** button.
4. When you are satisfied with your setting, press the **ENTER** button.
5. Press the **EXIT** button to exit.
 - In PC mode, you can only make changes to the "Colour Tone" and "Size" from among the items in "Picture Options".

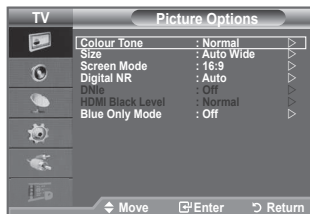
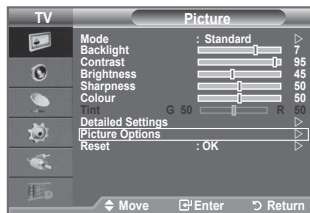

◆ Colour Tone: Cool2/Cool1/Normal/Warm1/Warm2

You can select the most comfortable colour tone to your eyes.

- The adjusted values are stored according to the selected Picture mode.
- "Warm1" or "Warm2" is only activated when the picture mode is "Movie".

◆ Size: Auto Wide/16:9/Wide Zoom/Zoom/4:3/Just Scan

You can select the picture size which best corresponds to your viewing requirements.

- ◆ **Auto Wide:** Automatically adjusts the picture size to the "16:9" aspect ratio.
- ◆ **16:9:** Adjusts the picture size to 16:9 appropriate for DVDs or wide broadcasting.
- ◆ **Wide Zoom:** Magnify the size of the picture more than 4:3.
- ◆ **Zoom:** Magnifies the 16:9 wide picture (in the vertical direction) to fit the screen size.
- ◆ **4:3:** This is the default setting for a video movie or normal broadcasting.
- ◆ **Just Scan:** Use the function to see the full image without any cutoff when HDMI (720p/1080i/1080p) or Component (1080i/1080p) signals are input.

- "Auto Wide" function is available only in "TV", "DTV", "Ext.1", "Ext.2", "AV", and "S-Video" mode.
- In PC Mode, only "16:9" and "4:3" mode can be adjusted.
- Settings can be adjusted and stored for each external device you have connected to an input of the TV.
- Temporary image retention may occur when viewing a static image on the set for more than two hours.
- **Wide Zoom:** Move the screen up/down using the **▲** or **▼** button after selecting the **☰** by pressing the **▶** or **ENTER** button.
- **Zoom:** Select **☰** by pressing the **◀** or **▶** button. Use the **▲** or **▼** button to move the picture up and down. After selecting **☰**, use the **▲** or **▼** button to magnify or reduce the picture size in the vertical direction.
- **After selecting "Just Scan" in HDMI (1080i/1080p) or Component (1080i/1080p) mode:** Select **☰** by pressing the **◀** or **▶** button. Use the **▲**, **▼**, **◀** or **▶** button to move the picture. **Reset:** Press the **◀** or **▶** button to select "Reset", then press the **ENTER** button. You can initialize the setting.

- ☰ You can select these options by simply pressing the **P.SIZE** button on the remote control.

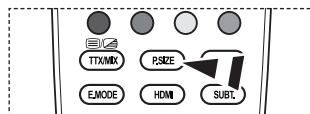

◆ **Screen Mode: 16:9/ Wide Zoom/Zoom/4:3**

When setting the picture size to "Auto Wide" in a 16:9 wide TV, you can determine the picture size you want to see the 4:3 WSS (Wide Screen Service) image or nothing. Each individual European country requires different picture size so this function is intended for users to select it.

◆ **16:9:** Sets the picture to 16:9 wide mode

◆ **Wide Zoom:** Magnify the size of the picture more than 4:3.

◆ **Zoom:** Magnify the size of the picture vertically on screen.

◆ **4:3:** Sets the picture to 4:3 normal mode.

> This function is available in "Auto Wide" mode.

> This function is not available in "PC", "Component" or "HDMI" mode.

◆ **Digital NR: Off/Low/Medium/High/Auto**

If the broadcast signal received by your TV is weak, you can activate the Digital Noise Reduction feature to help reduce any static and ghosting that may appear on the screen.

> When the signal is weak, select one of the other options until the best picture is displayed.

◆ **DNle: Off/Demo/On**

This TV includes the DNle function so as to provide a high visual quality. If you set DNle to on, you can view the screen with the DNle feature activated. If you set the DNle to Demo, you can view the applied DNle and normal pictures on the screen, for demonstration purposes. Using this function, you can view the difference in the visual quality.

> DNle™ (Digital Natural Image engine) **DNle™**

This feature brings you more detailed image with 3D noise reduction, detail enhancement, contrast enhancement and white enhancement. New image compensation Algorithm gives brighter, clearer, more detailed image to you. DNle™ technology will fit every signal into your eyes.

> This function is not available in "Movie" and "Standard" mode.

◆ **HDMI Black Level: Normal/Low**

You can select the black level on the screen to adjust the screen depth.

> This function is active only when the external input connects to HDMI(RGB signals).

◆ **Blue Only Mode: Off/On**

This function is for AV device measurement experts. This function displays the blue signal only by removing the red and green signals from the video signal so as to provide a Blue Filter effect that is used to adjust the Colour and Tint of video equipment such as DVD players, Home Theaters, etc.

Using this function, you can adjust the Colour and Tint to preferred values appropriate to the signal level of each video device using the Red/Green/Blue/Cyan/Magenta/Yellow Colour Bar Patterns, without using an additional Blue Filter.

> "Blue Only Mode" is available when the picture mode is set to "Movie" or "Standard".

Sound Features

1. Press the **MENU** button to display the menu.
Press the **▲** or **▼** button to select "Sound", then press the **ENTER** button.
2. Select the required option by pressing the **▲** or **▼** button, then press the **ENTER** button.
3. When you are satisfied with your setting, press the **ENTER** button.
4. Press the **EXIT** button to exit.

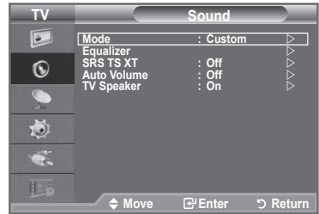

- ◆ **Mode: Standard/Music/Movie/Speech/Custom**
You can select the type of special sound effect to be used when watching a given broadcast.

Easy Setting

1. Press the **TOOLS** button on the remote control.
2. Press the **▲** or **▼** button to select "Sound Mode".
3. Press the **◀** or **▶** button to select the desired sound mode.
4. Press the **EXIT** or **TOOLS** button to exit.

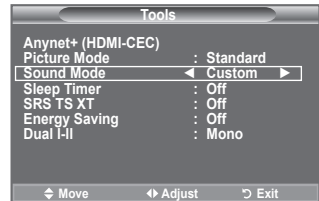

- ◆ **Equalizer: Balance/100Hz/300Hz/1kHz/3kHz/10kHz**

The sound settings can be adjusted to suit your personal preferences.

- If you make any changes to these settings, the sound mode is automatically switched to "Custom".

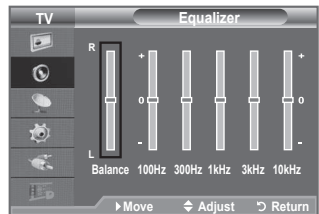



- ◆ **SRS TS XT: Off/On**

TruSurround XT is a patented SRS technology that solves the problem of playing 5.1 multichannel content over two speakers. TruSurround delivers a compelling, virtual surround sound experience through any two-speaker playback system, including internal television speakers. It is fully compatible with all multichannel formats.

Easy Setting

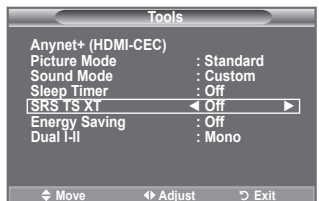
1. Press the **TOOLS** button on the remote control.
2. Press the **▲** or **▼** button to select "SRS TS XT".
3. Press the **◀** or **▶** button to select the "Off" or "On".
4. Press the **EXIT** or **TOOLS** button to exit.



TruSurround XT, SRS and  Symbol are trademarks of SRS Labs, Inc. TruSurround XT technology is incorporated under license from SRS Labs, Inc.

◆ **Auto Volume: Off/On**

Each broadcasting station has its own signal conditions, and so it is not easy to adjust the volume every time the channel is changed. This feature lets you automatically adjust the volume of the desired channel by lowering the sound output when the modulation signal is high or by raising the sound output when the modulation signal is low.

◆ **TV Speaker: Off/On**

If you want to hear the sound through separate speakers, cancel the internal amplifier.

- The ◀ +, ▶ - and MUTE buttons do not operate when the "TV Speaker" is set to "Off".
- When "TV Speaker" is set to "Off", the Sound menus cannot be adjusted.



Manufactured under license from Dolby Laboratories. Dolby and the double-D symbol are trademarks of Dolby Laboratories.

Selecting the Sound Mode

You can set the sound mode in the "Tools" menu. When you set to "Dual I-II", the current sound mode is displayed on the screen.

1. Press the **TOOLS** button on the remote control.
2. Press the ▲ or ▼ button to select "Dual I-II".
3. Press the ◀ or ▶ button to select required option.
4. Press the **ENTER** button.

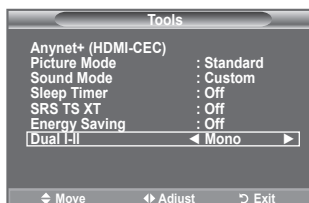

	Audio Type	Dual 1/2	Default
A2 Stereo	Mono	MONO	Automatic change
	Stereo	STEREO ↔ MONO	
	Dual	DUAL 1 ↔ DUAL 2	DUAL 1
NICAM Stereo	Mono	MONO	Automatic change
	Stereo	MONO ↔ STEREO	
	Dual	MONO ↔ DUAL 1 DUAL 2	DUAL 1

- If the stereo signal is weak and an automatic switching occurs, then switch to the Mono.
- This function is only activated in stereo sound signal. It is deactivated in mono sound signal.
- This function is only available in Analogue TV mode.

Connecting Headphones (Sold separately)

You can connect a set of headphones to your set if you wish to watch a TV programme without disturbing the other people in the room.

- When you insert the head set jack into the corresponding port, you can operate only "Auto Volume" in Sound menu.
- Prolonged use of headphones at a high volume may damage your hearing.
- You will not receive sound from the speakers when you connect headphones to the system.
- The headphone volume and TV volume are adjusted differently.



Setting and Displaying the Current Time

You can set the TV's clock so that the current time is displayed when you press the INFO button. You must also set the time if you wish to use the automatic On/Off timers.

1. Press the **MENU** button to display the menu.
Press the **▲** or **▼** button to select "Setup", then press the **ENTER** button.
2. Press the **▲** or **▼** button to select "Time", then press the **ENTER** button.
3. Press the **ENTER** button to select "Clock Set".

To...	Press the...
Move to "Month", "Day", "Year", "Hour" or "Minute"	◀ or ▶ button.
Set the "Month", "Day", "Year", "Hour" or "Minute"	▲ or ▼ button.
Confirm the setting	ENTER button.

5. Press the **EXIT** button to exit.

> If you disconnect the power cord, you have to set the clock again.

> You can also set "Month", "Day", "Year", "Hour" and "Minute" by pressing the number buttons on the remote control.

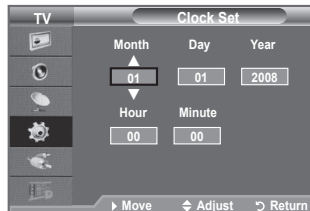

Setting the Sleep Timer

You can select a time period of between 30 and 180 minutes after which the television automatically switches to standby mode.

1. Press the **MENU** button to display the menu.
Press the **▲** or **▼** button to select "Setup", then press the **ENTER** button.
 2. Press the **▲** or **▼** button to select "Time", then press the **ENTER** button.
 3. Press the **▲** or **▼** button to select "Sleep Timer", then press the **ENTER** button.
 4. Press the **▲** or **▼** button repeatedly until the desired time appears (Off, 30, 60, 90, 120, 150, 180).
Press the **ENTER** button.
 5. Press the **EXIT** button to exit.
- > The TV automatically switches to standby mode when the timer reaches 0.

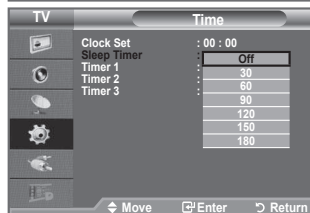

Easy Setting

1. Press the **TOOLS** button on the remote control.
2. Press the **▲** or **▼** button to select "Sleep Timer".
3. Press the **◀** or **▶** button to select the minute.
4. Press the **EXIT** or **TOOLS** button to exit.

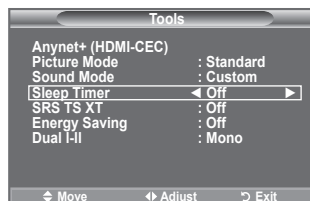

Switching the Television On and Off Automatically

1. Press the **MENU** button to display the menu.
Press the **▲** or **▼** button to select "Setup", then press the **ENTER** button.
2. Press the **▲** or **▼** button to select "Time", then press the **ENTER** button.
3. Press the **▲** or **▼** button to select "Timer 1", "Timer 2", "Timer 3", then press the **ENTER** button.
Three different On/Off Timer Settings can be made.
➤ You must set the clock first.
4. Press the **◀** or **▶** button to select the required item below.
Press the **▲** or **▼** button to adjust to the setting satisfied.
 - ◆ **On Time:** Select hour, minute, and "On"/"Off". (To activate timer with the setting satisfied, set to "On".)
 - ◆ **Off Time:** Select hour, minute, and "On"/"Off". (To activate timer with the setting satisfied, set to "On".)
 - ◆ **Repeat:** Select "Once", "Everyday", "Mon~Fri", "Mon~Sat", or "Sat~Sun".
 - ◆ **Volume:** Select the desired turn on volume level.
 - You can set the hour and minute directly by pressing the number buttons on the remote control.
 - **Auto Power Off**
When you set the timer On, the TV will eventually turn off, if no controls are operated for 3 hours after the TV was turned on by timer. This function is only available in timer On mode and prevents overheating, which may occur if a TV is on for too long time.

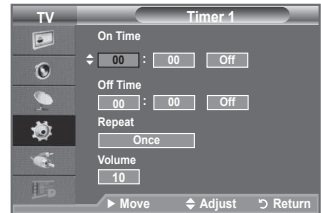
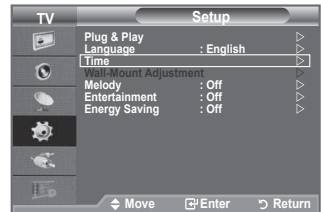

Choosing Your Language

When you start using your set for the first time, you must select the language which will be used for displaying menus and indications.

1. Press the **MENU** button to display the on-screen menu.
Press the **▲** or **▼** button to select "Setup", then press the **ENTER** button.
2. Press the **▲** or **▼** button to select "Language", then press the **ENTER** button.
3. Select a particular language by pressing the **▲** or **▼** button repeatedly.
Press the **ENTER** button.
4. Press the **EXIT** button to exit.



Melody / Entertainment / Energy Saving

1. Press the **MENU** button to display the menu. Press the **▲** or **▼** button to select "Setup", then press the **ENTER** button.
2. Select the required option by pressing the **▲** or **▼** button, then press the **ENTER** button.
3. When you are satisfied with your setting, press the **ENTER** button.
4. Press the **EXIT** button to exit.



- ◆ **Melody: Off/Low/Medium/High**
The TV power on/off melody sound can be adjusted.

- **The Melody does not play**

- When no sound is output from the TV because the **MUTE** button has been pressed.
- When no sound is output from the TV because the **⊖** (Volume) button has been pressed.
- When the TV is turned off by Sleep Timer function.

- ◆ **Entertainment: Off/Sports/Cinema/Game**

The "Entertainment" mode enables you to select the optimal display and sound for sports, cinema and games.

- **Off:** Switch the "Entertainment" function off.
- **Sports:** Provides the optimal picture and sound quality for sports. You can enjoy more thrilling Colour and sound.
- **Cinema:** Provides the optimal picture and sound quality for cinema. You can experience a richer picture and enhanced sound.
- **Game:** Provides the optimal picture and sound quality for games. This mode accelerates the playing speed when using an external game console connected to the TV.
- If you set any of the three "Entertainment" modes to On, the settings will be locked and can not be adjusted. If you want to make Picture and Sound mode adjustments, the "Entertainment" mode must be turned off.
- The "Entertainment" settings are saved for each input source.
- If you set any of the three "Entertainment" modes to On, "SRS TS XT" and "Equalizer" function is not available.
- This function is not available in PC mode.

- 📖 You can press the **E.MODE** button on the remote control repeatedly to change the "Entertainment" setting.

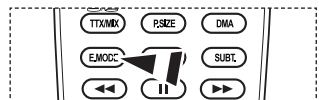

◆ **Energy Saving: Off/Low/Medium/High/Auto**

This feature adjusts the screen brightness depending on the surrounding lighting conditions.

- **Off:** Turns off the energy saving function.
- **Low:** Sets the TV to low energy saving mode.
- **Medium:** Sets the TV to medium energy saving mode.
- **High:** Sets the TV to high energy saving mode.
- **Auto:** Automatically adjusts the brightness of the TV screen in accordance with the scenes.

Easy Setting

1. Press the **TOOLS** button on the remote control.
2. Press the **▲** or **▼** button to select "Energy Saving".
3. Press the **◀** or **▶** button to select the "Off", "Low", "Medium", "High" or "Auto".
4. Press the **EXIT** or **TOOLS** button to exit.

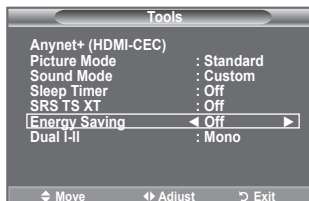

Selecting the Source

You can select among external sources connected to your TV's input jacks.

1. Press the **MENU** button to display the menu. Press the **▲** or **▼** button to select "Input", then press the **ENTER** button.
2. Press the **ENTER** button again, to select "Source List".
 - > Available signal sources: TV, Ext.1, Ext.2, AV, S-Video, Component, PC, HDMI1, HDMI2, HDMI3, DTV.
 - > You can choose only those external devices that are connected to the TV.
3. Select the required device by pressing the **▲** or **▼** button. Press the **ENTER** button.

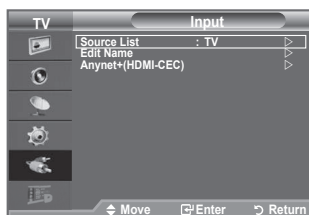

- ④ Press the **SOURCE** button on the remote control to toggle between all the available source. TV mode can be selected by pressing the **TV/DTV** button, number buttons(0~9), and the **PC** button on the remote control.

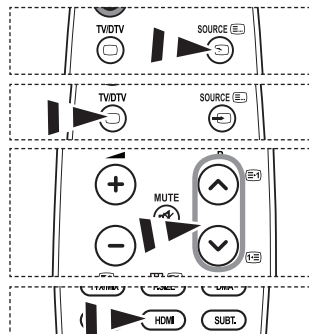

- ④ You can also watch HDMI mode simply by pressing the **HDMI** button on the remote control.

Editing the Input Source Names

Name the device connected to the input jacks to make your input source selection easier.

1. Press the **MENU** button to display the menu.
Press the **▲** or **▼** button to select "Input", then press the **ENTER** button.
2. Press the **▲** or **▼** button to select "Edit Name", then press the **ENTER** button.
3. Press the **▲** or **▼** button to select the device that you wish to edit.
Press the **ENTER** button.
4. Press the **▲** or **▼** button to select the required device.
Press the **ENTER** button.
5. Press the **EXIT** button to exit.
 - When a PC with a resolution of 1280 x 1024@60Hz is connected to the HDMI IN 2 port, you should set the "HDMI2" mode to "PC" in the "Edit Name" of the "Input" mode.



Previewing the DTV Menu System

- ◆ The company does not guarantee the normal operation of the DTV menu for countries other than the supported countries (France, Germany, Italy, Netherlands, Spain, Switzerland, United Kingdom, Austria) because only these country standards are supported.

In addition, when the country of the broadcast stream differs from the country selected by the current user, the string appearing in the channel banner, Info, Guide, Channel Manager, etc. may not be displayed properly.

- ◆ Available in DTV mode. Preset to the DTV mode by using the **TV/DTV** button on your remote control. To help you navigate around the on-screen menu system and adjust the various settings available, refer to the following illustration.

Press the **MENU** button to display the menu.

Press the **▲** or **▼** button to select "Digital Menu", then press the **ENTER** button.

Guide	
— Now & Next Guide	
— Full Guide	
— Scheduled List	
— Default Guide	Now/Next, Full Guide
Digital Channel	
— Country	
— Auto Store	
— Manual Store	
— Edit Favourite Channels	
— Channel List	All, Favourites, Default
Setup	
— Menu Transparency	High, Medium, Low, Opaque
— Change PIN	
— Parental Lock	
— Subtitle	Off, On
— Subtitle Mode	Normal, Hard of hearing
— Audio Format	PCM, Dolby Digital
— Audio Description	Audio Description — Off, On Volume
— Digital Text	Disable, Enable
— Time Zone	
— Common Interface	Application Info, CI Menu
— System	Product Information Signal Information Software Upgrade Reset
Language	
— Audio Language	Primary Audio Language
— Subtitle Language	Secondary Audio Language
— Teletext Language	Primary Subtitle Language
— Preference	Secondary Subtitle Language Primary Teletext Language Secondary Teletext Language (Depending On the Country)

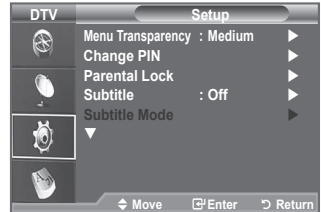
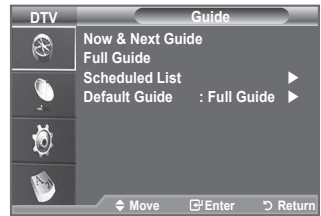

➤ The sub-items of the CI Menu may vary depending on the CAM model.

Updating the Channel List Automatically

You can update the channel list when the broadcaster adds new Services or if you move the TV to a new location.

1. Press the **MENU** button to display the menu.
Press the **▲** or **▼** button to select "Digital Menu", then press the **ENTER** button.
2. Press the **▲** or **▼** button to select "Digital Channel", then press the **ENTER** button.
3. Press the **ENTER** button again, to select "Country".
4. Select the appropriate country by pressing the **▲** or **▼** button.
Press the **ENTER** button to confirm your choice.
 - Even though you have changed the country setting in this menu, the country setting for Analogue TV is not changed. (Refer to page 11)
5. Press the **▲** or **▼** button again, to select "Auto Store".
Press the **ENTER** button.
 - When it has finished, the number of scanned services will be displayed.
 - The existing favourite channel list will not be deleted when the channel list is updated.
 - To stop the scan before it has finished, press the **ENTER** button with "STOP" selected.
6. Select the **EXIT** button to exit.
 - If the signal status is poor, the "No Service found! Check the aerial connection" message is displayed.

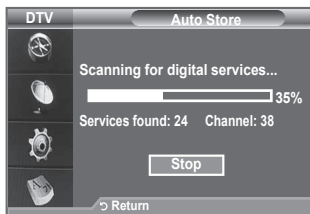

Updating the Channel List Manually

You can specify the channel for a fast channel search.

1. Press the **MENU** button to display the menu.
Press the **▲** or **▼** button to select "Digital Menu", then press the **ENTER** button.
2. Press the **▲** or **▼** button to select "Digital Channel", then press the **ENTER** button.
3. Press the **▲** or **▼** button to select "Manual Store", then press the **ENTER** button.
4. Press the **▲** or **▼** button to select the required option, then press the **ENTER** button.
 - - **Channel** : Channel "5" to "69" in sequence are displayed (depending on the country)
 - **Frequency** : The frequency available in the Channel group is displayed.
 - **Bandwidth** : The available bandwidths are 7 and 8 MHz.
 - Press the red button to start the scan for digital services.
When it has finished, channels are updated in the channel list.
5. When it has finished, the number of scanned services will be displayed.
6. Press the **EXIT** button to exit.

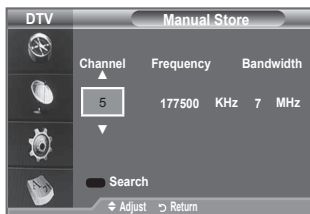

Editing Your Favourite Channels

You can edit your favourite channels using the four colour buttons.

1. Press the **MENU** button to display the menu.
Press the **▲** or **▼** button to select "Digital Menu", then press the **ENTER** button.
2. Press the **▲** or **▼** button to select "Digital Channel", then press the **ENTER** button.
3. Press the **▲** or **▼** button to select "Edit Favourite Channels", then press the **ENTER** button.
4. Press the red button to display all currently stored channels.
5. Press the **▲** or **▼** button to select a channel you want.
Press the **ENTER** button.
 - A "★" icon is shown next to the selected channel and the channel will be added to the favourite channel list.
 - • To undo, press the **ENTER** button again.
 - **Select All**: Select all channels currently displayed.
 - **Select None**: Deselect all selected channels.
 - **Preview**: Displays (a) currently selected channel(s).
 - The Favourite Channels settings have been completed.
6. Press the **EXIT** button to exit.

◆ Add

You can use this function when one or more favourite channels have been selected.

1. Press the **MENU** button to display the menu.
Press the **▲** or **▼** button to select "Digital Menu", then press the **ENTER** button.
2. Press the **▲** or **▼** button to select "Digital Channel", then press the **ENTER** button.
3. Press the **▲** or **▼** button to select "Edit Favourite Channels", then press the **ENTER** button.
4. Press the red button in the "Edit Favourite Channels" menu.
To add more channels, refer to the step 5 on the previous
5. If you want to check the channel to be stored, press **RETURN** button.
Press the **EXIT** button to exit.
 - • To add all channels to the favourite channel list, press the red button.
 - To remove all channels, press the green button.
 - **Preview** : Displays (a) currently selected channel(s).
 - Press the **CH LIST** button to display the favourite channel manager.

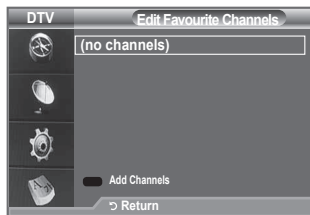

◆ Renumber (depending on the country)

1. Press the **MENU** button to display the menu.
Press the **▲** or **▼** button to select "Digital Menu", then press the **ENTER** button.
2. Press the **▲** or **▼** button to select "Digital Channel", then press the **ENTER** button.
3. Press the **▲** or **▼** button to select "Edit Favourite Channels", then press the **ENTER** button.
4. Select the required channel using the **▲** or **▼** button.
5. Press the green button.
 - The space for entering the number is a blank.
6. Enter the new channel number. Press **ENTER** button to store or **RETURN** button to cancel.
 - Press the **◀** button to delete an entered digit.
 - If you enter a number already assigned to another channel, the number is assigned to the selected channel and the previous number assigned to the selected channel is assigned to the other channel.
That is, the two numbers are exchanged.
 - The Favourite Channels are automatically sorted in ascending order of channel numbers.
7. Press the **EXIT** button to exit.



◆ Preview

1. In the "Edit Favourite Channels" menu, select the channel to be previewed by pressing the **▲** or **▼** button.
2. Press the yellow button.
 - The selected channel is displayed on the screen.

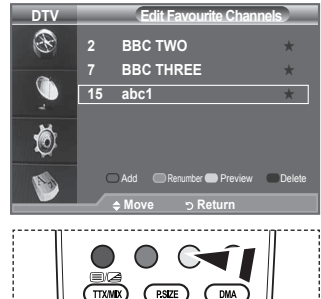

◆ Delete

1. In the "Edit Favourite Channels" menu, select the channel to be deleted from the favourite channels list by pressing the **▲** or **▼** button.
2. Press the blue button.
 - The selected channel and number will be deleted.
 - To add a deleted channel back in to the favourite channel list, see "Add" on page 30.

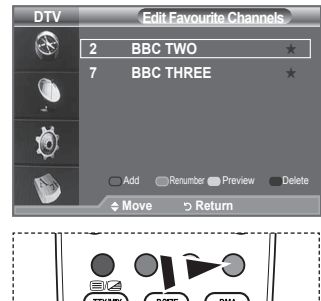

Selecting Channel List

You can exclude the channels you have chosen from the channels you have scanned. When you scan through the stored channels, those you have chosen to skip are not displayed. All channels that you do not specifically choose to skip are displayed during scanning.

- Press the **MENU** button to display the menu.
Press the **▲** or **▼** button to select "Digital Menu", then press the **ENTER** button.
- Press the **▲** or **▼** button to select "Digital Channel", then press the **ENTER** button.
- Press the **▲** or **▼** button to select "Channel List".
Press the **ENTER** button.
- Press the **▲** or **▼** button to select "All", "Favourites" or "Default".
Press the **ENTER** button.
- Press the yellow button to toggle between your favourite channels and all channels.
 - Your favourite channels are only displayed if they were previously set in the "Editing Your Favourite Channels" menu (refer to page 30).
- Press the red or green button to display the previous or next channel List page.
- Press the **▲** or **▼** button to select a channel to be tuned.
Press the **ENTER** button.
 - The channel number, name and an icon are displayed in the top left corner while changing the channel. The channel number and name are displayed if the channel is one of the all channels, and a ★ icon if the channel is one of the favourite channels.
- Press the blue button to toggle between your "TV", "Radio", "Data/Other" and "All".
- Press the **CH LIST** button to exit from the channel List.



It can be displayed simply by pressing the **CH LIST** button.

Displaying Programme Information

While viewing a channel, additional information about the current programme may be displayed.

- While viewing a programme, press the **INFO** button.
 - The programme information is displayed.
- To exit from banner information, press the **INFO** button.
 - The information is displayed:
 - Parental Rating
 - Video Type: SD, HD, Radio
 - Audio Type: Mono, Stereo, Dual, Dolby Digital
 - Existence of Teletext or DVB Subtitle
 - Audio Language

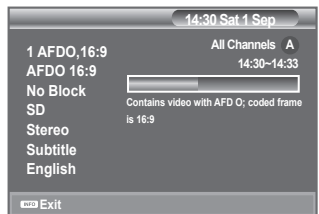

Viewing the EPG (Electronic Programme Guide) Information

The EPG (Electronic Programme Guide) information is provided by the broadcasters. Programme entries may appear blank or out of date as a result of the information broadcast on a given channel. The display will dynamically update as soon as new information becomes available.

◆ Now & Next Guide

For the six channels indicated in the left-hand column, displays the Current programme and the Next programme information.

◆ Full Guide

Displays the programme information as time ordered One hour segments. Two hours of programme information is displayed which may be scrolled forwards or backwards in time.

1. Press the **MENU** button to display the menu.
Press the **▲** or **▼** button to select "Digital Menu", then press the **ENTER** button.
2. Press the **ENTER** button, to select "Guide".
3. Press the **▲** or **▼** button to select "Now & Next Guide" or "Full Guide".
Press the **ENTER** button.
➤ You can also display the guide menu simply by pressing the **GUIDE** button.

To...	Then...
Watch a programme in the EPG list	<ul style="list-style-type: none"> • Select a programme by pressing the ▲, ▼, ◀, ▶ button. • Press the ENTER button.
	<ul style="list-style-type: none"> ➤ If the next programme is selected, it is scheduled with the clock icon displayed. If the ENTER button is pressed again, the scheduling is cancelled with the clock icon gone. For details about scheduling programmes, refer to the next page.
View programme information	<ul style="list-style-type: none"> • Select a programme of your choice by pressing the ▲, ▼, ◀, ▶ button. • Press the INFO button when the programme of your choice is highlighted.
Toggle between the "Now & Next Guide" or "Full Guide"	<ul style="list-style-type: none"> • Press the red button repeatedly.
Display the "Favourites" and the "All Channels" list	<ul style="list-style-type: none"> • Press the green button repeatedly.
Scrolls backwards quickly (24 hours).	<ul style="list-style-type: none"> • Press the yellow button repeatedly.
Scrolls forward quickly (24 hours).	<ul style="list-style-type: none"> • Press the blue button repeatedly.
Exit the guide	<ul style="list-style-type: none"> • Press the EXIT button.

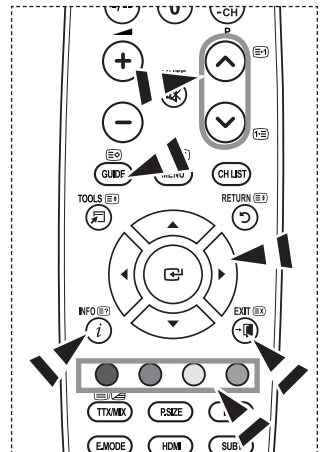
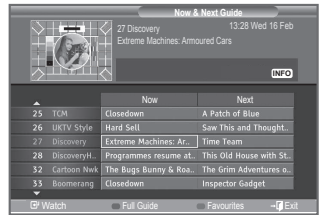

- The programme title is on the upper part of the screen center. Please click on **INFO** button for the detailed information. Channel Number, Running Time, Status Bar, Parental Level, Video Quality Information (HD/SD), Sound Modes, Subtitle or Teletext, Languages of Subtitle or Teletext, and brief summary of the highlighted programme are included on the detailed information. "... " will be appeared if the summary is long.
- Six channels are displayed. To scroll between channels, move to a channel using the **▲** or **▼** button. To display page by page, use the **P ▲** or **P ▼** button.

Using the Scheduled List

If you make a scheduled viewing list of programs you may like to see, the channel will be automatically switched to the scheduled programme at the scheduled time even if you are watching another programme.

1. Press the **MENU** button to display the menu.
Press the **▲** or **▼** button to select "Digital Menu", then press the **ENTER** button.
2. Press the **ENTER** button, to select "Guide".
3. Press the **▲** or **▼** button to select "Scheduled List", then press the **ENTER** button.
4. Press the red button.
The channel will be switched to the scheduled programme.
5. Press the **ENTER** button to select an item and adjust with the **▲** or **▼** button .
 - You can also set hour and minute by pressing the number buttons on the remote control.
 - **Channel:** Set the channel.
 - **Time:** Set the time.
 - **Date:** Set Year, Month and Day.
 - **Frequency:** Set the frequency.
("Once", "Daily", or "Weekly")
6. After setting the schedule, Press the red button.
7. Press the **EXIT** button to exit.
 - • **Save:** Save the adjusted schedule.
 - **Cancel:** Cancel the adjusted schedule.
 - **Add Programme:** Add a new schedule.
 - **Edit:** Readjust the selected schedule.
 - **Delete:** Delete the selected schedule.

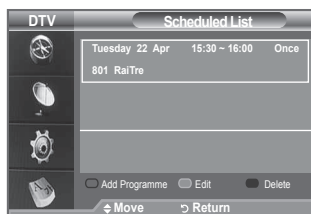

Setting the Default Guide

You can preset the default guide style.

1. Press the **MENU** button to display the menu.
Press the **▲** or **▼** button to select "Digital Menu", then press the **ENTER** button.
2. Press the **ENTER** button, to select "Guide".
3. Press the **▲** or **▼** button to select "Default Guide", then press the **ENTER** button.
4. Select "Now/Next" or "Full Guide" using the **▲** or **▼** button, and press the **ENTER** button.
5. Press the **EXIT** button to exit.

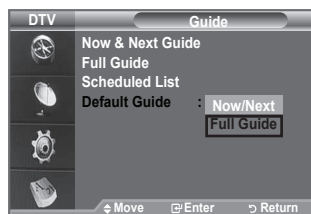

You can select these options by simply pressing the **GUIDE** button on the remote control.

Viewing All Channels and Favourite Channels

In the EPG menu, you can display all channels or favourite channels.

- Press the **MENU** button to display the menu.
Press the **▲** or **▼** button to select "Digital Menu", then press the **ENTER** button.
- Press the **ENTER** button again, to select "Guide".
- Select the your required guide ("Now & Next Guide" or "Full Guide") by pressing the **▲** or **▼** button.
- Press the **ENTER** button.
- Press the green button.
All the channel lists and the Favourite Channel lists will be toggled.
- Select a programme of your choice by pressing the **▲**, **▼**, **◀**, or **▶** button.
- Press the **INFO** button to display information about the highlighted programme.
- When the Edit Favourite Channels list has not been set up:
 - "The favourites list is empty. Would you like to choose your favourites now?" message is displayed.
 - Select "Yes".
The "Edit Favourite Channels" menu is displayed.
If you select "No", all channels will remain unchanged.
 - To edit the favourite channels, refer to page 30 for more details.
- Press the **EXIT** button to exit.
 - "All Channels" is the list of channels that have been scanned by the channel list update.
All channels are displayed in the all channel mode.
 - "Favourites" (favourite channels) is the list of channels that has been set in the "Edit Favourite Channels" menu (refer to page 30).

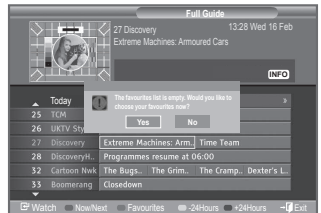
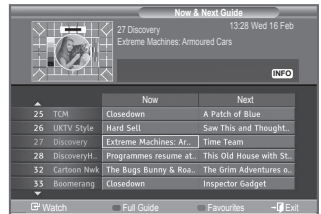
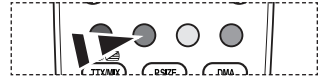

Adjusting the Menu Transparency

You can set the Transparency of the menu.

- Press the **MENU** button to display the menu.
Press the **▲** or **▼** button to select "Digital Menu", then press the **ENTER** button.
- Press the **▲** or **▼** button to select "Setup", then press the **ENTER** button.
- Press the **▲** or **▼** button to select "Menu Transparency" then press the **ENTER** button.
- Select the required option ("High", "Medium", "Low", or "Opaque") by pressing the **▲** or **▼** button, and press the **ENTER** button to change the setting.
- Press the **EXIT** button to exit.

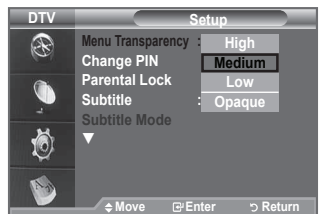

Setting up the Parental Lock

This feature allows you to prevent unauthorized users, such as children, from watching unsuitable programmes by a 4-digit PIN (Personal Identification Number) code that is defined by the user. The on-screen menu will instruct you to assign a PIN code (you can change it later, if necessary).

1. Press the **MENU** button to display the menu.
Press the **▲** or **▼** button to select "Digital Menu", then press the **ENTER** button.
2. Press the **▲** or **▼** button to select "Setup", then press the **ENTER** button.
3. Press the **▲** or **▼** button to select "Parental Lock.", then press the **ENTER** button.
4. The "Enter PIN" is displayed.
5. Enter your current 4-digit PIN code by using the numeric buttons (0~9).
 - The default PIN code for a new TV set is 0000.
 - If you enter an invalid PIN code, the "Invalid PIN code. Please try again." message is displayed.
6. Press the **ENTER** button.
7. Press the **▲** or **▼** button to select the age rating you want to lock out.
Press the **ENTER** button.

◆ Change PIN

1. Press the **MENU** button to display the menu.
Press the **▲** or **▼** button to select "Digital Menu", then press the **ENTER** button.
2. Press the **▲** or **▼** button to select "Setup", then press the **ENTER** button.
3. Press the **▲** or **▼** button to select "Change PIN", then press the **ENTER** button.
 - The "Enter PIN" is displayed.
4. Enter your current 4-digit PIN code by using the numeric buttons (0~9).
 - The "Enter New PIN" is displayed.
5. Enter your new PIN code by using the numeric buttons (0~9)
 - The "Confirm New PIN" is displayed.
6. Re-enter your new PIN code to confirm by using the numeric buttons (0~9).
 - The "Your PIN code has been changed successfully." message is displayed.
7. Press the **ENTER** button.
8. Press the **EXIT** button to exit.
 - If you forget the PIN code, press the remote control buttons in the following sequence, which resets the PIN to **0-0-0-0:POWER (Off), MUTE, 8, 2, 4, POWER (On)**.

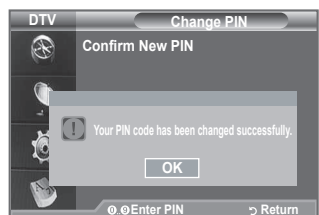
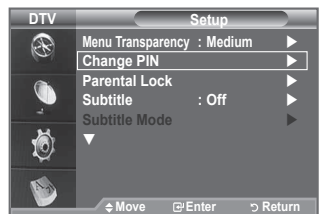
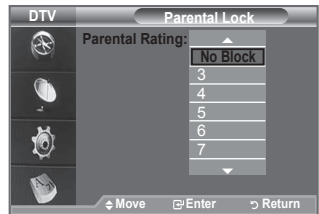
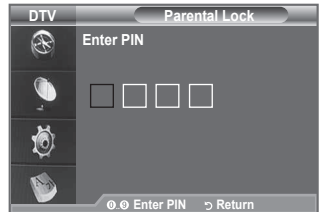
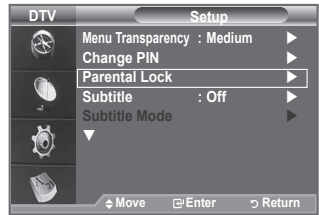

Setting the Subtitle

You can activate and deactivate the subtitles.

1. Press the **MENU** button to display the menu.
Press the **▲** or **▼** button to select "Digital Menu", then press the **ENTER** button.
2. Press the **▲** or **▼** button to select "Setup", then press the **ENTER** button.
3. Press the **▲** or **▼** button to select "Subtitle", then press the **ENTER** button.
4. Select "On" by pressing the **▲** or **▼** button. Press the **ENTER** button.
5. Press the **EXIT** button to exit.

 You can select these options simply by pressing the **SUBT.** button on the remote control.

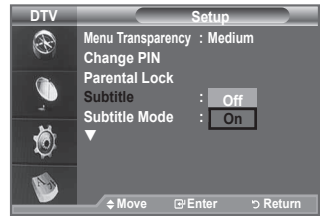

Setting the Subtitle Mode

Use this menu to set the Subtitle Mode. "Normal" under the menu is the basic subtitle and "Hard of hearing" is the subtitle for a hearing-impaired person.

1. Press the **MENU** button to display the menu.
Press the **▲** or **▼** button to select "Digital Menu", then press the **ENTER** button.
2. Press the **▲** or **▼** button to select "Setup", then press the **ENTER** button.
3. Press the **▲** or **▼** button to select "Subtitle Mode", then press the **ENTER** button.
4. Press the **▲** or **▼** button to select "Normal" or "Hard of hearing". Press the **ENTER** button.
5. Press the **EXIT** button to exit.

➤ If the programme you are watching does not support the "Hard of hearing" function, "Normal" automatically activates even though "Hard of hearing" mode is selected.

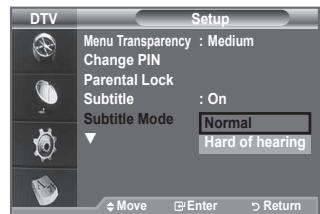

Selecting the Audio Format

You can only hear Dolby Digital sound through the audio receiver connected through an optical cable. You can only hear PCM sound through the main speaker.

When sound is emitted from both the main speaker and the audio receiver, a sound echo may occur due to the decoding speed difference between the main speaker and the audio receiver. In this case, use the internal mute function.

1. Press the **MENU** button to display the menu.
Press the **▲** or **▼** button to select "Digital Menu", then press the **ENTER** button.
2. Press the **▲** or **▼** button to select "Setup", then press the **ENTER** button.
3. Press the **▲** or **▼** button to select "Audio Format", then press the **ENTER** button.
4. Press the **▲** or **▼** button to select "PCM" or "Dolby Digital". Press the **ENTER** button.
5. Press the **EXIT** button to exit.

➤ The Audio Format appears according to the broadcasting signal. Dolby digital sound is only available when the TV is connected with an external speaker using an optical cable.

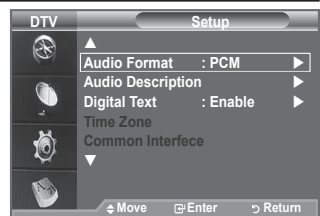

Selecting the Audio Description

This is an auxiliary audio function that provides an additional audio track for visually challenged persons. This function handles the Audio Stream for the AD (Audio Description), when it is sent along with the Main audio from the broadcaster. Users can turn the Audio Description On or Off and control the volume.

1. Press the **MENU** button to display the menu.
Press the **▲** or **▼** button to select "Digital Menu", then press the **ENTER** button.
2. Press the **▲** or **▼** button to select "Setup", then press the **ENTER** button.
3. Press the **▲** or **▼** button to select "Audio Description", then press the **ENTER** button.
4. Press the **▲** or **▼** button to select "On", then press the **ENTER** button.
5. Press the **▲** or **▼** button to select "Volume", then press the **ENTER** button.
 - "Volume" is active when "Audio Description" is set to "On".
6. Press the **◀** or **▶** button until you reach the optimal setting. Press the **ENTER** button.
7. Press the **EXIT** button to exit.

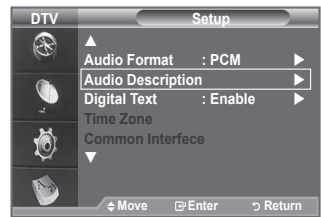

Selecting the Digital Text (UK only)

If the programme is broadcast with digital text, this feature is enabled.

1. Press the **MENU** button to display the menu.
Press the **▲** or **▼** button to select "Digital Menu", then press the **ENTER** button.
 2. Press the **▲** or **▼** button to select "Setup", then press the **ENTER** button.
 3. Press the **▲** or **▼** button to select "Digital Text", then press the **ENTER** button.
 4. Press the **▲** or **▼** button to select "Disable" or "Enable". Press the **ENTER** button.
 5. Press the **EXIT** button to exit.
- MHEG (Multimedia and Hypermedia Information Coding Experts Group) An International standard for data encoding systems used in multimedia and hypermedia. This is at a higher level than the MPEG system which includes data-linking hypermedia such as still images, character service, animation, graphic and video files as well as multimedia data. MHEG is user runtime interaction technology and is being applied to various fields including VOD (Video-On-Demand), ITV (Interactive TV), EC (Electronic Commerce), tele-education, tele-conferencing, digital libraries and network games.

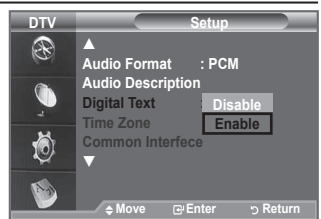

Selecting the Time Zone (Spain only)

Select the local time zone.

1. Press the **MENU** button to display the menu.
Press the **▲** or **▼** button to select "Digital Menu", then press the **ENTER** button.
2. Press the **▲** or **▼** button to select "Setup", then press the **ENTER** button.
3. Press the **▲** or **▼** button to select "Time Zone", then press the **ENTER** button.
4. Select the time zone where you locate by pressing the **▲** or **▼** button.
Press the **ENTER** button.
 - The following options are available
The Iberian Peninsula and Balearic Islands -
Canary Islands
5. Press the **EXIT** button to exit.



Viewing Product Information

You can view your product information. For service or repair, please contact a Samsung approved dealer.

1. Press the **MENU** button to display the menu.
Press the **▲** or **▼** button to select "Digital Menu", then press the **ENTER** button.
2. Press the **▲** or **▼** button to select "Setup", then press the **ENTER** button.
3. Press the **▲** or **▼** button to select "System", then press the **ENTER** button.
4. Press the **ENTER** button again, to select "Product Information".
 - The Product Information menu is selected.
- Software Version, Firmware Version
5. Press the **EXIT** button to exit.

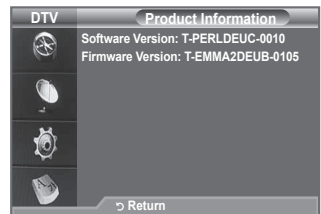

Checking the Signal Information

You can get information about the signal status.

1. Press the **MENU** button to display the menu.
Press the **▲** or **▼** button to select "Digital Menu", then press the **ENTER** button.
 2. Press the **▲** or **▼** button to select "Setup", then press the **ENTER** button.
 3. Press the **▲** or **▼** button to select "System", then press the **ENTER** button.
 4. Press the **▲** or **▼** button to select "Signal Information", then press the **ENTER** button.
 5. Press the **EXIT** button to exit.
- If the signal status is poor, the "No signal." message is displayed.

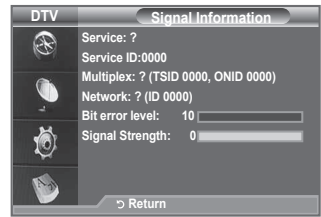

Upgrading the Software

To keep your product up-to-date with new Digital Television features then software upgrades are periodically broadcast as part of the normal Television signal. It will automatically detect these signals and display the software upgrade banner. You are given the option to install the upgrade.

1. Press the **MENU** button to display the menu.
Press the **▲** or **▼** button to select "Digital Menu", then press the **ENTER** button.
2. Press the **▲** or **▼** button to select "Setup", then press the **ENTER** button.
3. Press the **▲** or **▼** button to select "System", then press the **ENTER** button.
4. Press the **▲** or **▼** button to select "Software Upgrade", then press the **ENTER** button.
5. Press the **▲** or **▼** button to select "Software Information", "Manual Upgrade" or "Standby Mode upgrade".
Press the **ENTER** button.

◆ Software Information

Press the **ENTER** button, then the current software version is shown. To display the software version information, press the **ENTER** button again.
To switch to an alternative version, press the red button.
Press the blue button to reset, activate the upgrade and restart.

◆ Manual Upgrade

Press the **ENTER** button to search for new software from the currently broadcasting channels.

◆ Standby Mode Upgrade: On / Off

Press the **ENTER** button. To continue software upgrade with master power on, Select On by pressing the **▲** or **▼** button. 45 minutes after entering standby mode, a manual upgrade is automatically conducted. Since the power of the unit is turned on internally, the screen may be on slightly for the LCD product. This phenomenon may continue for more than 1 hour until the software upgrade is completed.

6. Press the **EXIT** button to exit.

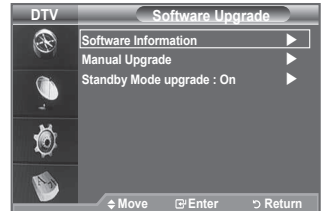
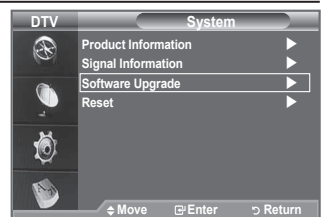

Viewing Common Interface

This contains information on CAM inserted in the CI slot and displays it.

1. Press the **MENU** button to display the menu.
Press the **▲** or **▼** button to select "Digital Menu", then press the **ENTER** button.
2. Press the **▲** or **▼** button to select "Setup", then press the **ENTER** button.
3. Press the **▲** or **▼** button to select "Common Interface", then press the **ENTER** button.
4. Press the **ENTER** button to display the information for your application.
5. Press the **EXIT** button to exit.
➤ The Application Info inserting is about the CI CARD.
You can install the CAM anytime whether the TV is ON or OFF.
 1. Purchase the CI CAM module by visiting your nearest dealer or by phone.
 2. Insert the CI CARD into the CAM in the direction of the arrow until it fits.
 3. Insert the CAM with the CI CARD installed into the common interface slot.
(Insert the CAM in the direction of the arrow, right up to the end so that it is parallel with the slot.)
 4. Check if you can see a picture on a scrambled signal channel.

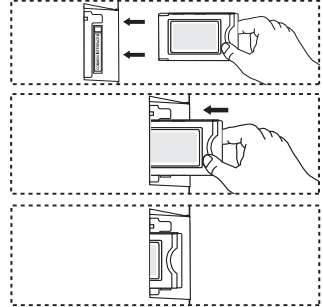
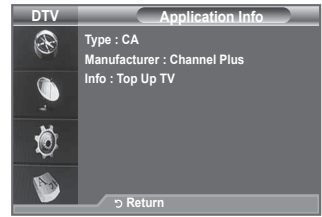

Selecting the CI (Common Interface) Menu

This enables the user to select from the CAM-provided menu.

1. Press the **MENU** button to display the menu.
Press the **▲** or **▼** button to select "Digital Menu", then press the **ENTER** button.
2. Press the **▲** or **▼** button to select "Setup", then press the **ENTER** button.
3. Press the **▲** or **▼** button to select "Common Interface", then press the **ENTER** button.
4. Select to "CI Menu" by pressing the **▲** or **▼** button, and press the **ENTER** button.
5. Select the required option by pressing the **▲** or **▼** button, and press the **ENTER** button.
6. Press the **EXIT** button to exit.
➤ Select the CI Menu based on the menu PC Card.

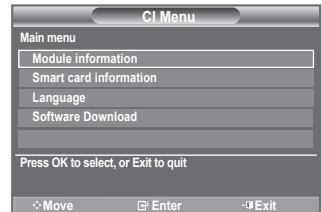

Resetting

You can reset the values stored to the factory default values.

- The Reset operation deletes all channel information and user preferences returning all values to their default factory state.
- 1. Press the **MENU** button to display the menu.
Press the ▲ or ▼ button to select "Digital Menu", then press the **ENTER** button.
- 2. Press the ▲ or ▼ button to select "Setup", then press the **ENTER** button.
- 3. Press the ▲ or ▼ button to select "System", then press the **ENTER** button.
- 4. Press the ▲ or ▼ button to select "Reset", then press the **ENTER** button.
- 5. The "Enter PIN" screen will appear.
- 6. Enter your current 4-digit PIN code by using the numeric buttons (0~9).
 - The warning message is displayed. All values will be reset by pressing the coloured buttons (red, green, yellow, and blue) in turn.
- 7. Press the **EXIT** button to exit.

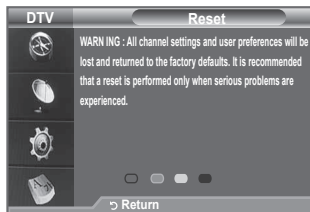
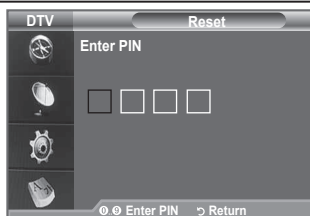

Selecting the Preferred Language (Subtitle, Audio or Teletext)

You can change the default value for subtitle, audio teletext languages.

Displays the language information for the incoming stream.

1. Press the **MENU** button to display the menu.
Press the ▲ or ▼ button to select "Digital Menu", then press the **ENTER** button.
2. Press the ▲ or ▼ button to select "Language", then press the **ENTER** button.
3. Press the ▲ or ▼ button to select "Audio Language", "Subtitle Language" or "Teletext Language".
Press the **ENTER** button.
4. Select a particular language by pressing the ▲ or ▼ button repeatedly.
Press the **ENTER** button.
 - English is the default in cases where the selected language is unavailable in the broadcast.
5. Press the **EXIT** button to exit.
 - While viewing a programme, the subtitle can be selected
 - While viewing a programme, audio languages can be selected.



Preference

This menu consists of 6 sub-menus:

Primary Audio Language, Secondary Audio Language, Primary Subtitle Language, Secondary Subtitle Language, Primary Teletext Language, Secondary Teletext Language.

Using this feature, users can select one of the languages (English, German, Italian, Swedish, French, Welsh, Gaelic, Irish, Danish, Finnish, Spanish, Dutch). The language selected here is the default when the user selects a channel.



- ◆ Press the ▲ or ▼ button to select required menu (Primary Audio Language, Secondary Audio Language, Primary Subtitle Language, Secondary Subtitle Language, Primary Teletext Language, Secondary Teletext Language), then press the **ENTER** button. The options of the selected menu are displayed.
- ◆ Select the appropriate language by pressing the ▲ or ▼ button. Press the **ENTER** button to confirm your choice.
- If you change the language setting, the Subtitle Language, Audio Language, and the Teletext Language of the Language menu (refer to page 42) are automatically changed to the selected language.
- The Subtitle Language, Audio Language, and the Teletext Language of the Language menu show a list of languages supported by the current channel and the selection is highlighted. If you change this language setting, the new selection is only valid for the current channel. The changed setting does not change the setting of the Primary Subtitle Language, Primary Audio Language, or the Primary Teletext Language of the Preference menu.

Setting up Your PC Software (Based on Windows XP)

The Windows display-settings for a typical computer are shown below. The actual screens on your PC may be different depending upon your particular version of Windows and your particular video card. Even if your actual screens look different, the same, basic set-up information will apply in almost all cases. (If not, contact your computer manufacturer or Samsung Dealer.)



1. First, click on "Control Panel" on the Windows start menu.
2. When the control panel window appears, click on "Appearance and Themes" and a display dialog-box will appear.
3. When the control panel window appears, click on "Display" and a display dialog-box will appear.
4. Navigate to the "Settings" tab on the display dialog-box.
The correct size setting (resolution): Optimum- 1280 X 1024
If a vertical-frequency option exists on your display settings dialog box, the correct value is "60" or "60 Hz". Otherwise, just click "OK" and exit the dialog box.

Display Modes

Both screen position and size will vary depending on the type of PC monitor and its resolution. The resolutions in the table are recommended.

➤ D-Sub Input

Mode	Resolution	Horizontal Frequency (kHz)	Vertical Frequency (Hz)	Pixel Clock Frequency (MHz)	Sync Polarity (H/V)
IBM	640 x 350	31.469	70.086	25.175	+ / -
	720 x 400	31.469	70.087	28.322	- / +
VESA	640 x 480	31.469	59.940	25.175	- / -
	640 x 480	37.861	72.809	31.500	- / -
	640 x 480	37.500	75.000	31.500	- / -
	800 x 600	37.879	60.317	40.000	+ / +
	800 x 600	48.077	72.188	50.000	+ / +
	800 x 600	46.875	75.000	49.500	+ / +
	1024 x 768	48.363	60.004	65.000	- / -
	1024 x 768	56.476	70.069	75.000	- / -
	1024 x 768	60.023	75.029	78.750	+ / +
	1280 x 1024	63.981	60.020	108.000	+ / +
	1280 x 1024	79.976	75.025	135.000	+ / +

➤ HDMI/DVI Input

Mode	Resolution	Horizontal Frequency (kHz)	Vertical Frequency (Hz)	Pixel Clock Frequency (MHz)	Sync Polarity (H/V)
VESA	640 x 480	31.469	59.940	25.175	- / -
	800 x 600	37.879	60.317	40.000	+ / +
	1024 x 768	48.363	60.004	65.000	- / -
	1280 x 1024	63.981	60.020	108.000	+ / +

- When using an HDMI/DVI cable connection, you must use the HDMI IN 2 jack.
- The interlace mode is not supported.
- The set might operate abnormally if a non-standard video format is selected.
- Separate and Composite modes are supported. SOG is not supported.
- Too long or low quality VGA cable can cause picture noise at high resolution modes.

Setting up the TV with your PC

➤ **Preset:** Press the **SOURCE** button to select PC mode.

1. Press the **MENU** button to display the menu. Press the **ENTER** button, to select "Picture".
2. Select the required option by pressing the **▲** or **▼** button, then press the **ENTER** button.
3. When you are satisfied with your setting, press the **ENTER** button.
4. Press the **EXIT** button to exit.

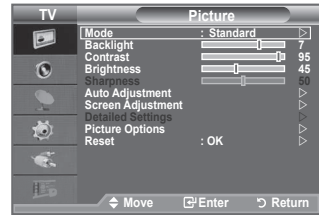

◆ Auto Adjustment

Auto adjustment allows the PC screen of set to self-adjust to the incoming PC video signal. The values of fine, coarse and position are adjusted automatically.

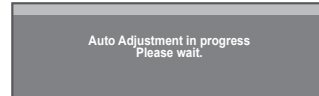

Easy Setting

1. Press the **TOOLS** button on the remote control.
2. Press the **▲** or **▼** button to select "Auto Adjustment", then press the **ENTER** button.

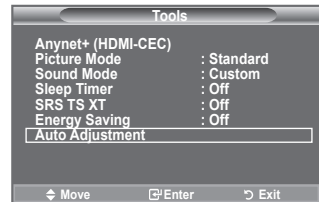

◆ Screen Adjustment: Coarse/Fine

The purpose of picture quality adjustment is to remove or reduce picture noise. If the noise is not removed by Fine-tuning alone, then adjust the frequency as best as possible (coarse) and Fine-tune again. After the noise has been reduced, re-adjust the picture so that it is aligned on the center of screen.

Press the **▲** or **▼** button to select "Coarse" or "Fine", then press the **ENTER** button.

Press the **◀** or **▶** button to adjust the screen quality. Press the **ENTER** button.

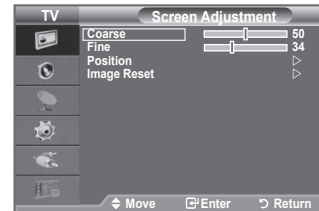

Position

Adjust the PC's screen positioning if it does not fit the TV screen.

Press the **▲** or **▼** button to adjusting the Vertical-Position.

Press the **◀** or **▶** button to adjust the Horizontal-Position.

Press the **ENTER** button.

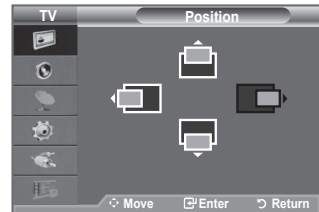
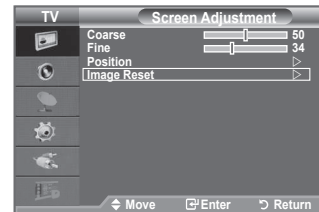

Image Reset

You can replace all image settings with the factory default values.



What is Anynet+?

Anynet+ is an AV network system that enables an easy-to-use AV interface for users by controlling all connected AV devices through the Anynet+ menu when Samsung Electronics AV devices are connected.

Connecting Anynet+ Devices

The Anynet+ system supports AV devices supporting Anynet+ only.

Check if there is an Anynet+ mark on the AV device to be connected to the TV.

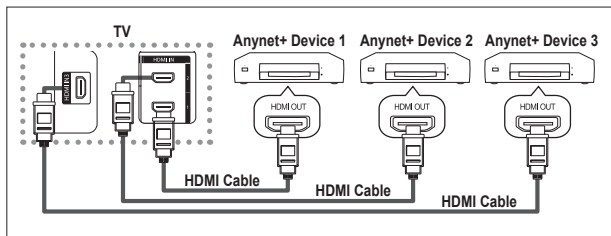

To directly connect to TV

Connect the [HDMI 1], [HDMI 2] or [HDMI 3] jack on the TV and the HDMI OUT jack of the corresponding Anynet+ device using the HDMI cable.

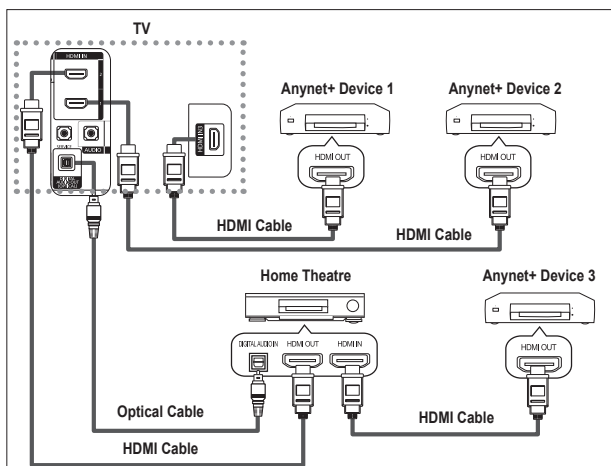

To connect to Home Theater

1. Connect the [HDMI 1], [HDMI 2] or [HDMI 3] jack on the TV and the HDMI OUT jack of the corresponding Anynet+ device using the HDMI cable.
2. Connect the HDMI IN jack of the home theatre and the HDMI OUT jack of the corresponding Anynet+ device using the HDMI cable.

- Connect only the optical cable between [Digital Audio Out (Optical)] on your TV and Digital Audio Input on the receiver.
- Connect only one receiver.
- You can listen to 5.1 channel sound through the home theatre's speakers. Otherwise, you can only listen to 2 channel stereo sound in other cases. Make sure to connect the Digital Audio IN (Optical) of the home theatre and the TV correctly to listen to TV sound through the home theatre. However, you cannot listen to sound from the BD recorder that is sent to the home theatre via the TV in 5.1 channel sound because the TV outputs only 2 channel stereo sound. Please see the manual for the home theatre.
- You can connect an Anynet+ device using the HDMI cable. Some HDMI cables may not support Anynet+ functions.
- Anynet+ works when the AV device supporting Anynet+ is in the Standby or On status.
- Anynet+ supports up to 8 AV devices in total.

Setting Up Anynet+

The following settings are to use Anynet+ functions.

Using the Anynet+ Function

1. Press The **TOOLS** button. Then Press the **ENTER** button to select "Anynet+(HDMI-CEC)". Press the **▲** or **▼** button to select "Setup", then press the **ENTER** button.
2. Press the **ENTER** button to select "Anynet+ (HDMI-CEC)", then press the **ENTER** button.
3. Press the **▲** or **▼** button to select "On", then press the **ENTER** button.
 - The "Anynet+ (HDMI-CEC)" function is enabled.
 - If you select "Off", "Anynet+ (HDMI-CEC)" is disabled.
 - When the "Anynet+ (HDMI-CEC)" function is disabled, all the Anynet+ related operations are deactivated.

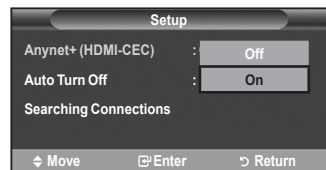
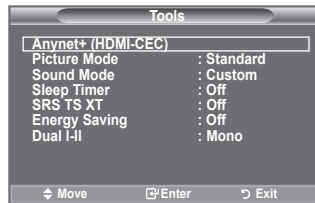

Turning an Anynet+ Device Off Automatically when the TV is Turned Off

1. Press the **▲** or **▼** button to select "Auto Turn Off", then press the **ENTER** button.
2. Press the **▲** or **▼** button to select "Yes", then press the **ENTER** button.
 - The Auto turn off function is enabled.
 - If you select "No", the Auto turn off function is cancelled. Press the **EXIT** button to exit.
 - The Select Device setting of the TV remote control is to be set to TV to use the Anynet+ function.
 - If you set "Auto Turn Off" to "Yes", connected external devices are also turned off when the TV is turned off. However, if the device is recording, it may not be turned off.

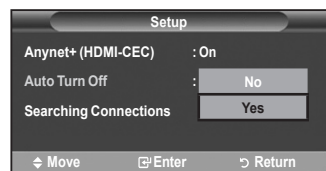

Scanning and Switching between Anynet+ Devices

1. Press the **TOOLS** button. Then press the **ENTER** button to select "Anynet+(HDMI-CEC)".
2. Press the **▲** or **▼** button to select "Select Device", then press the **ENTER** button.
3. Press the **▲** or **▼** button to select to a particular device and press the **ENTER** button. It is switched to the selected device.
4. If you cannot find a device you want, press the **▲** or **▼** button to select "Setup", then press the **ENTER** button.
5. Press the **▲** or **▼** button to select "Searching Connections", then press the **ENTER** button.

The message "Configuring Anynet+ connection..." is displayed. When searching devices completes, the connected devices are listed in the Anynet+ menu.

- Switching to the selected devices may take up to 2 minutes. You cannot cancel the operation during the switching operation.
- The time required to scan for devices is determined by the number of connected devices.
- When the device scan is complete, the number of found devices is not displayed.
- Although the TV automatically scans devices when it is turned on using the **POWER** button, devices connected when the TV is on or under a specific circumstance are not displayed in the device list. Therefore select "Searching Connections" menu to search devices.
- If you have selected external input mode by pressing the **SOURCE** button, you cannot use the Anynet+ function. Make sure to switch to an Anynet+ device by using the **TOOLS** button.



Anynet+ Menu

The Anynet+ menu changes depending on the type and status of the Anynet+ devices connected to the TV.

Anynet+ Menu	Description
View TV	Switches from Anynet+ to TV broadcast mode.
Select Device	Your TV connects to the corresponding device.
Record	Starts a recording. (This menu works only for a device supporting recording.)
Menu on Device	Shows the menu of the connected device. Example. When a DVD Recorder is connected, the DVD Recorder's title menu appears.
Device Operation	Shows the play control menu of the connected device. Example. When a DVD Recorder is connected, the play control menu of the DVD Recorder appears.
Receiver	Sound is output through the receiver.
Setup	You can set the environment for using Anynet+.

TV Remote Control Buttons Available in Anynet+ Mode

Device Type	Operating Status	Available Buttons
Anynet+ Device	After switching to the device, when the menu of the corresponding device is displayed on the screen.	Numeric buttons ▲/▼/◀/▶/ENTER/EXIT buttons Colour buttons EXIT button
	After switching to the device, while playing a file	◀◀(Backward search)/ ▶▶(Forward search)/ ■(Stop)/ ▶(Play) ⏸(Pause)
Device with built-in Tuner	After switching to the device, when you are watching a TV programme	P▲/▼ button
Audio Device	When Receiver is activated	▲(+) / ▼(-) button/ MUTE button

- The Anynet+ function only works when the remote control is set to TV.
- The [■] button works only while in the recordable state.
- You cannot control Anynet+ devices using the buttons on the TV. You can control Anynet+ devices only using the TV remote control.
- The TV remote control may not work under certain conditions. In this case, re-select the Anynet+ device.
- The Anynet+ functions don't operate for the products from other manufacturers.
- In Anynet+ mode, the colour buttons may not work properly.
- The ◀◀, ▶▶ operations may differ depending on the device.

Recording

You can make a recording of a TV programme using a recorder.

Press the  button.

Recording begins. (Only when the Anynet+ enabled recording device is connected.)

- The current TV programme is recorded in the Watching TV status. If you are watching video from another device, the video from the device is recorded.
- You can also record the source streams by selecting "Record" after pressing the **TOOLS** button.
- Before recording, check whether the antenna jack is properly connected to the recording device. For the antenna connection to the recording device, refer to its user manual.

Listening through a Receiver

You can listen to sound through a receiver instead of the TV speaker.

1. Press the **TOOLS** button. Then Press the **ENTER** button to select "Anynet+(HDMI-CEC)".

Press the **▲** or **▼** button to select "Receiver", then press the **ENTER** button.

2. Press the **◀** or **▶** button to select to "On", then press the **ENTER** button.

Now you can listen to sound through the receiver.

3. Press the **EXIT** button to exit.

- When the receiver is set to On, you can listen to the TV sound through the 2-channel receiver.
- If the receiver is exclusively for a home theatre only (supporting audio only), it may not appear in the device list.
- Only when you have connected the optical jack of the TV and the receiver properly, does Receiver work.
- In case of a content with copyright problem, listening through the receiver may not properly operate.
- If there is a power interruption to the TV when the "Receiver" is set to "On" (by disconnecting the power cord or a power failure), the "TV Speaker" may be set to "Off" when you turn the TV on again. (see page 22)















Check Points before Requesting Service

Symptom	Solution
Anynet+ does not work.	<ul style="list-style-type: none"> ■ Check if the device is an Anynet+ device. The Anynet+ system supports Anynet+ devices only. ■ Connect only one receiver. ■ Check if the Anynet+ device power cord is properly connected. ■ Check the Anynet+ device's Video/Audio/HDMI cable connections. ■ Check whether Anynet+ (HDMI-CEC) is set to On in the Anynet+ setup menu. ■ Check whether the TV remote control is in TV mode. ■ Check whether it is Anynet+ exclusive remote control. ■ Anynet+ doesn't work at a certain condition. (Searching channels, Plug & Play, etc.) ■ When connecting or removing the HDMI cable, please make sure to search devices again or restart your TV. ■ Check if the Anynet+ Function of Anynet+ device is set on.
I want to start Anynet+.	<ul style="list-style-type: none"> ■ Check if the Anynet+ device is properly connected to the TV and check if the Anynet+ (HDMI-CEC) is set to On in the Anynet+ Setup menu. ■ Press the TV/DTV button on the TV remote control to switch to TV. Then press the TOOLS button to show the Anynet+ menu and select a menu you want.
I want to exit Anynet+.	<ul style="list-style-type: none"> ■ Select View TV in Anynet+ menu. ■ Press the SOURCE button on the TV remote control and select a device other than Anynet+ devices. ■ Press any of P (with a TV icon), PRE-CH, and such to change to the TV mode. (Note that the channel button operates only when a tuner-embedded Anynet+ device is not connected.)
The Configuring Anynet+ connection message appears on the screen.	<ul style="list-style-type: none"> ■ You cannot use the remote control when you are configuring Anynet+ or switching to a view mode. ■ Use the remote control when the Anynet+ setting or switching to view mode is complete.
The Anynet+ device does not play.	You cannot use the play function when Plug & Play is in progress.
The connected device is not displayed.	<ul style="list-style-type: none"> ■ Check whether or not the device supports Anynet+ functions. ■ Check whether or not the HDMI cable is properly connected. ■ Check whether Anynet+ (HDMI-CEC) is set to On in the Anynet+ setup menu. ■ Search Anynet+ devices again. ■ You can connect an Anynet+ device using the HDMI cable only. Some HDMI cables may not support Anynet+ functions. ■ If it is terminated by an abnormal situation such as disconnecting the HDMI cable or power cord or a power failure, please repeat the device scan.
The TV programme cannot be recorded.	Check whether the antenna jack on the recording device is properly connected.
The TV sound is not output through the receiver.	Connect the optical cable between TV and the receiver.

Teletext Feature

Most television stations provide written information services via Teletext. The index page of the teletext service gives you information on how to use the service. In addition, you can select various options to suit your requirements by using the remote control buttons.

➤ For teletext information to be displayed correctly, channel reception must be stable. Otherwise, information may be missing or some pages may not be displayed.

- 1  (exit)
Exit from the teletext display
- 2  (index)
Used to display the index (contents) page at any time while you are viewing teletext.
- 3  (store)
Used to store the teletext pages.
- 4  (size)
Press to display the double-size letters in the upper half of the screen. For lower half of the screen, press it again. To display normal screen, press it once again.
- 5  (reveal)
Used to display the hidden text (answers to quiz games, for example). To display normal screen, press it again.
- 6  (teletext on/mix)
Press to activate teletext mode after selecting the channel providing the teletext service. Press it twice to overlap the teletext with the current broadcasting screen.
- 7  (mode)
Press to select the teletext mode (LIST/FLOF). If you press it in the LIST mode, it switches into the List save mode. In the List save mode, you can save teletext page into list using the  (store) button.
- 8  (sub-page)
Used to display the available sub-page.
- 9  (page up)
Used to display the next teletext page.
- 10  (page down)
Used to display the previous teletext page.
- 11  (hold)
Used to hold the display on a given page if the selected page is linked with several secondary pages which follow on automatically. To resume, press it again.
- 12  (cancel)
Used to display the broadcast when searching for a page.
- 13 **Colour buttons (red/green/yellow/blue)**
If the FASTEXT system is used by a broadcasting company, the different topics covered on a teletext page are colour-coded and can be selected by pressing the coloured buttons. Press one of them corresponding to the required. The page is displayed with other coloured information that can be selected in the same way. To display the previous or next page, press the corresponding coloured button.

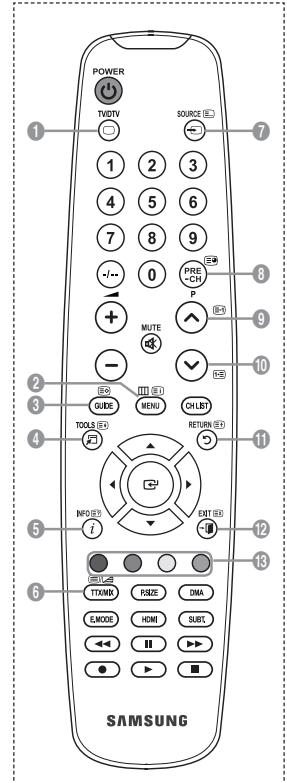

➤ You can change teletext pages by pressing the numeric buttons on the remote control.

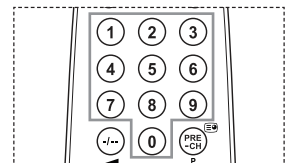

The teletext pages are organized according to six categories:

Part	Contents
A	Selected page number.
B	Broadcasting station identity.
C	Current page number or search status.
D	Date and time.
E	Text.
F	Status information. FASTEXT information.

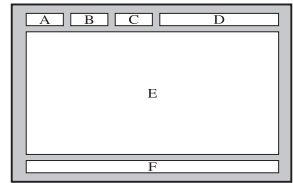

- > Teletext information is often divided between several pages displayed in sequence, which can be accessed by:
 - ◆ Entering the page number
 - ◆ Selecting a title in a list
 - ◆ Selecting a coloured heading (FASTEXT system)
- > Press the **TV/DTV** button to exit from the teletext display.

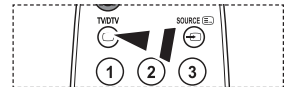

Wall-Mount Adjustment

Once the auto wall mount is installed, your TV's position can be easily adjusted.

➤ This function is optional and may not be supported.

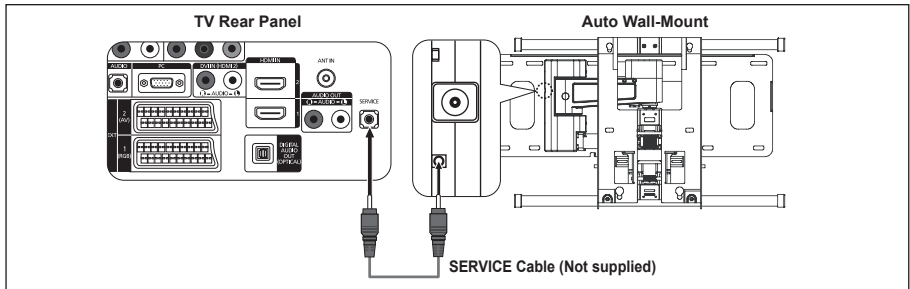

Entering the menu

- Press the **▲**, **▼**, **◀** or **▶** button on your remote control.
 - The Wall Mount Adjustment screen is displayed.
 - If the Wall Mount Adjustment screen is not displayed when clicking on a direction button while watching your TV, use the menu to display that screen.
 - Press the **MENU** button to display the menu.
 - Press the **▲** or **▼** button to select "Setup", then press the **ENTER** button.
 - Press the **▲** or **▼** button to select "Wall-Mount Adjustment", then press the **ENTER** button.



Remembering the Position

- Adjust to the desired position using the **▲**, **▼**, **◀**, **▶** buttons.
 - If you press an arrow button when no OSD is displayed on the TV screen, the Adjustment screen appears.
 - Press the **INFO** button to reset. Press the **◀** or **▶** button to select "Yes", then press the **ENTER** button. The position is initialized to the default setting.
- Press the blue button.
 - Press the **▲** and **▼** buttons to select a save mode from either Position 1, Position 2 or Position 3 in order to save the current position.
 - To not save the current position, press the **RETURN** button.
 - When selecting a save mode, you cannot use the Colour buttons.
- Press the **ENTER** button to save.
 - When Position1 is selected, the message "Current position saved as Position1" is displayed.
- Press the **ENTER** button.
 - The saved Position appears on the left side of the OSD.

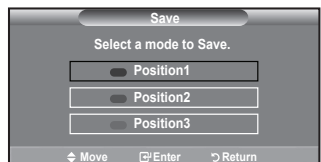
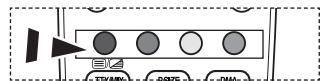

Moving to the remembered position

1. Complete Step 1 of "Entering the menu".
2. Pressing a Colour (Red, Green, Yellow) button moves the auto wall mount to the saved position.
 - You can move the wall mount to one of the 3 pre-set positions by pressing the Red (Position 1), Green (Position 2) or Yellow (Position 3) buttons.
 - If you adjust the Position after moving to a pre-set position, the position display will disappear.

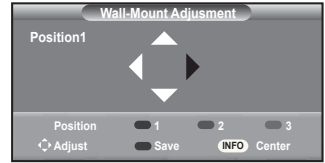

- For installation, refer to the Installation Manual provided with the wall mount.
- For product installation and the installation and moving of the wall mount, make sure to consult a specialized installation company.
- This installation manual is to be used when attaching the wall mount to a wall. When attaching to other building materials, please contact your nearest dealer.
- The auto wall mount will not work when Anynet+ is operating.
- 40 inch model are not compatible with the old electrically powered wall mount model (WMN5090A*).

Using the Anti-Theft Kensington Lock

The Kensington lock is a device used to physically fix the system when using it in a public place. The appearance and locking method may differ from the illustration depending on the manufacturer. Refer to the manual provided with the Kensington lock for proper use. The locking device has to be purchased separately.

1. Insert the locking device into the Kensington slot on the LCD TV (Figure 1), and turn it in the locking direction (Figure 2).
 2. Connect the Kensington lock cable.
 3. Fix the Kensington lock to a desk or a heavy stationary object.
- The location of the Kensington Lock may be different depending on its model.

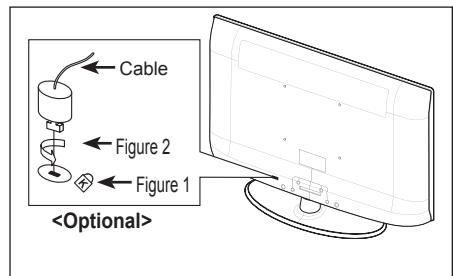

Securing the TV to the Wall



Caution: Pulling, pushing, or climbing on the TV may cause the TV to fall. In particular, ensure your children do not hang over or destabilize the TV; doing so may cause the TV to tip over, causing serious injuries or death. Follow all safety precautions provided on the included Safety Flyer. For added stability, install the anti-fall device for safety purposes, as follows.

To avoid the TV from falling:

1. Put the screws into the clamps and firmly fasten them onto the wall. Confirm that the screws have been firmly installed onto the wall.
 - You may need additional material such as an anchor depending on the type of wall.
 - Since the necessary clamps, screws, and string are not supplied, please purchase these additionally.

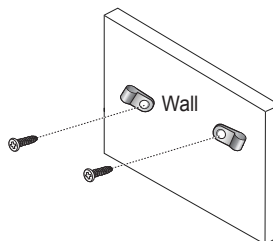

2. Remove the screws from the center back of the TV, put the screws into the clamps, and then fasten the screws onto the TV again.
 - Screws may not be supplied with the product. In this case, please purchase the screws of the following specifications.
Screw Specifications
 - For a 17 ~ 29 Inch LCD TV: M4 X 15
 - For a 32 ~ 40 Inch LCD TV: M6 X 15

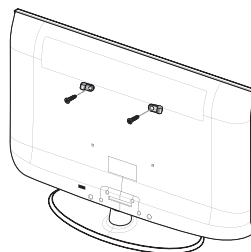

3. Connect the clamps fixed onto the TV and the clamps fixed onto the wall with a strong string and then tie the string tightly.
 - Install the TV near to the wall so that it does not fall backwards.
 - It is safe to connect the string so that the clamps fixed on the wall are equal to or lower than the clamps fixed on the TV.
 - Untie the string before moving the TV.

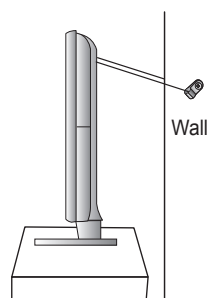

4. Verify all connections are properly secured. Periodically check connections for any sign of fatigue for failure. If you have any doubt about the security of your connections, contact a professional installer.

Troubleshooting: Before Contacting Service Personnel

No sound or picture.	<ul style="list-style-type: none"> ♦ Check that the mains lead has been connected to a wall socket. ♦ Check that you have pressed the ⏻ button on your set. ♦ Check the picture contrast and brightness settings. ♦ Check the volume.
Normal picture but no sound.	<ul style="list-style-type: none"> ♦ Check the volume. ♦ Check whether the MUTE  button has been pressed on the remote control. ♦ Check if "TV Speaker" is on.
Screen is black and power indicator light blinks steadily.	<ul style="list-style-type: none"> ♦ On your computer check; Power, Signal Cable. ♦ The TV is using its power management system. ♦ Move the computer's mouse or press any key on the keyboard.
No picture or black and white picture.	<ul style="list-style-type: none"> ♦ Adjust the colour settings. ♦ Check that the broadcast system selected is correct.
Sound and picture interference.	<ul style="list-style-type: none"> ♦ Try to identify the electrical appliance that is affecting the set and move it further away. ♦ Plug your set into a different mains socket.
Blurred or snowy picture, distorted sound.	<ul style="list-style-type: none"> ♦ Check the direction, location and connections of your aerial. <p>This interference is often due to the use of an indoor aerial.</p>
Remote control malfunctions.	<ul style="list-style-type: none"> ♦ Replace the remote control batteries. ♦ Clean the upper edge of the remote control (transmission window). ♦ Check the battery terminals.
'Check signal cable.' message is displayed.	<ul style="list-style-type: none"> ♦ Check that the signal cable is firmly connected to the PC or video sources. ♦ Check that the PC or video sources are turned on.
On PC mode, 'Not Supported Mode.' message is displayed.	<ul style="list-style-type: none"> ♦ Check the maximum resolution and the frequency of the video adaptor. ♦ Compare these values with the data in the Display Modes.
The damaged picture appears in the corner of the screen.	<p>If "Just Scan" is selected in some external devices, the damaged picture may appear in the corner of the screen. This symptom is caused by external devices, not TV.</p>
The 'Resets all settings to the default values' message appears.	<p>This appears when you press and hold the EXIT button for a while. The product settings are reset to the factory defaults.</p>

The TFT LCD panel uses a panel consisting of sub pixels (3 932 160) which require sophisticated technology to produce. However, there may be few bright or dark pixels on the screen. These pixels will have no impact on the performance of the product.

Technical and Environmental Specifications

Model Name	LE40A536
Screen Size (Diagonal)	40 inch
PC Resolution	1280 x 1024 @ 60 Hz
Sound	
Output	10W x 2
Dimensions (WxDxH)	
Body	971 X 87 X 628 mm
With stand	971 X 300 X 687 mm
Weight	
With stand	21 kg
Environmental Considerations	
Operating Temperature	10 °C to 40 °C (50 °F to 104 °F)
Operating Humidity	10 % to 80 %, non-condensing
Storage Temperature	-20 °C to 45 °C (-4 °F to 113 °F)
Storage Humidity	5 % to 95 %, non-condensing
Stand Swivel	
(Left / Right)	-20° ~ 20°

- Design and specifications are subject to change without prior notice.
- This device is a Class B digital apparatus.
- For the power supply and Power Consumption, refer to the label attached to the product.