

SWITEL

Schnurlos Telefon
Téléphone sans fil
Telefono senza fili
Cordless phone

D6025



Bedienungsanleitung
Mode d'emploi
Istruzioni per l'uso
Operating Instructions

SWITEL

D6025

Bedienungsanleitung _____ 1

Die Displayanzeigen sind in den Sprachen Deutsch, Französisch, Englisch und Italienisch einstellbar. Siehe dazu Kapitel 7.10.

Mode d'emploi _____ 23

Les messages peuvent être affichés à l'écran en allemand, en français, en anglais et en italien. Voir à cet effet le chapitre 7.10.

Istruzioni per l'uso _____ 43

Le visualizzazioni del display possono essere selezionate nelle lingue tedesco, francese, inglese ed italiano. Si veda a tal fine al capitolo 7.10.

Operating instructions _____ 63

The display messages can be set up in German, French, English and Italian. For more information see Chapter 7.10.

Declaration of conformity _____ 83

- Inhaltsverzeichnis -

1	Allgemeine Hinweise	4	6	Rufnummernanzeige (CLIP)	13
2	Bedienelemente	5	6.1	Die Anruferliste	13
3	Inbetriebnahme	6	6.2	Rufnummer aus der Anruferliste in das Telefonbuch speichern	14
3.1	Sicherheitshinweise	6	6.3	Einzelne Rufnummer aus der Anruferliste löschen	14
3.2	Verpackungsinhalt prüfen	6	6.4	Komplette Anruferliste löschen	14
3.3	Basisstation anschließen	6	7	Sonderfunktionen	15
3.4	Standard-Akkus einbauen	6	7.1	Rufsignale am Mobilteil einstellen (Klingelmelodien)	15
3.5	Aufladen der Standard-Akkus	6	7.2	Lautstärke des Tonrufs am Mobilteil	15
4	Bedienung	7	7.3	Rufsignale an der Basisstation einstellen (Klingelmelodien)	16
4.1	Das Display	7	7.4	Lautstärke des Tonrufs an der Basisstation	16
4.2	Anrufe entgegennehmen	7	7.5	Anrufe automatisch entgegennehmen	16
4.3	Anrufe führen	8	7.6	Ton (MFV-) oder Impuls (IWW) - Wahlverfahren	16
4.4	Gespeicherte Rufnummern aus dem Telefonbuch anwählen	8	7.7	Displaynamen ändern	16
4.5	Anzeige der Gesprächsdauer	8	7.8	Hinweistöne ein-/ausschalten	17
4.6	Mobilteil ein-/ausschalten	8	7.9	PIN-Code ändern	17
4.7	Hinweise zur Reichweite	8	7.10	Displaysprache einstellen	18
4.8	Mikrofon im Mobilteil stummschalten	9	7.11	FLASH-Zeit einstellen	18
4.9	Einstellen der Hörerlautstärke	9	7.12	Werkseinstellungen wieder herstellen	18
4.10	Wahlwiederholung	9	7.13	Menüstruktur	19
4.11	Tastatursperre	10	8	Mehrere Mobilteile	20
4.12	Temporäre Tonwahl	10	8.1	Intern telefonieren	20
4.13	Paging von der Basisstation zum Mobilteil	10	8.2	Externe Gespräche auf ein anderes Mobilteil verbinden	20
4.14	Nebenstellenanlagen	10	8.3	An- und abmelden von Mobilteilen	20
4.15	Pause benutzen	10	8.3.1	Anmelden von Mobilteilen	20
5	Das Telefonbuch	11	8.3.2	Anmelden von anderen DECT-GAP Telefonen an die Basisstation	21
5.1	Rufnummern in das Telefonbuch eingeben	11	8.3.3	Abmelden von Mobilteilen	21
5.2	Gespeicherte Rufnummern im Telefonbuch ändern	12		Zusätzliche Basisstationen	21
5.3	Gespeicherte Rufnummern aus dem Telefonbuch löschen	12	9	Fehlerbeseitigung	22
			10	Technische Daten	22

1 Allgemeine Hinweise

Aufladbare Batterien - Keine anderen aufladbaren Batterien oder Akkupacks verwenden. Diese können möglicherweise einen Kurzschluss verursachen. Verwenden Sie beim Austauschen immer nur **wiederaufladbare** Batterien des Typs AAA 1,2 Volt, 550 mAh. Batterien nicht ins Feuer werfen oder ins Wasser tauchen. Alte oder defekte Batterien nicht mit dem normalen Hausmüll entsorgen. Sollte sich der Handapparat beim Laden erwärmen, so ist dies normal und ungefährlich. Laden Sie den Handapparat nicht mit fremden Aufladegeräten, da sonst Beschädigungen auftreten können.

Aufstellort - Am Aufstellort muss sich eine Netzsteckdose 230 Volt befinden. Stellen Sie die Basisstation nicht in die unmittelbare Umgebung von anderen elektronischen Geräten wie z. B. Mikrowellen oder HIFI-Geräten, da es sonst zu gegenseitiger Beeinflussung kommen kann. Der Aufstellort hat einen entscheidenden Einfluss auf einen einwandfreien Betrieb des Telefons.

Stellen Sie die Basisstation auf eine ebene und rutschfeste Fläche. Normalerweise hinterlassen die FüÙe der Basisstation keine Spuren auf der Aufstellfläche. Wegen der Vielzahl der verwendeten Lacke und Oberflächen kann es jedoch nicht ausgeschlossen werden, dass durch die GerätefüÙe Spuren auf der Abstellfläche entstehen. Verwenden Sie den Handapparat nicht in explosionsgefährdeten Bereichen. Übermäßige Belastungen durch Rauch, Staub, Erschütterungen, Chemikalien, Feuchtigkeit, Hitze oder direkte Sonneneinstrahlung müssen vermieden werden.

Medizinischer Hinweis - Das Telefon arbeitet mit einer sehr geringen Sendeleistung. Diese geringe Sendeleistung schließt eine gesundheitliche Gefährdung nach dem derzeitigen Stand von Forschung und Technik aus. Es hat sich aber gezeigt, dass eingeschaltete tragbare Telefone medizinische Geräte beeinflussen können. Halten Sie deshalb bei medizinischen Geräten einen Abstand von mindestens einem Meter ein.

Entsorgung - Ist die Gebrauchszeit der wiederaufladbaren Batterien oder der gesamten Anlage abgelaufen, entsorgen Sie diese bitte umweltfreundlich gemäß den gesetzlichen Bestimmungen.

Temperatur und Umgebungsbedingungen - Das Telefon ist für den Betrieb in geschützten Räumen mit einem Temperaturbereich von 10 °C bis 30 °C ausgelegt. Die Basisstation darf nicht in Feuchträumen wie Bad oder Waschküche aufgestellt werden. Vermeiden Sie die Nähe zu Wärmequellen wie Heizkörpern und setzen Sie das Gerät keiner direkten Sonnenbestrahlung aus.

Reinigung und Pflege Die Gehäuseoberflächen können mit einem trockenen, weichen und fusselreifen Tuch gereinigt werden. Niemals Reinigungsmittel oder gar aggressive Lösungsmittel verwenden. Außer einer gelegentlichen Gehäusereinigung ist keine weitere Pflege erforderlich. Die GummifüÙe der Basisstation sind nicht gegen alle Reinigungsmittel beständig. Der Hersteller kann daher nicht für evtl. Schäden an Möbeln o. ä. haftbar gemacht werden.

2 Bedienelemente

Mobilteil

- 1 Gesprächsanzeige
- 2 Wahlwiederholung
- 3 Menü- und Bestätigungstaste
- 4 Auswahltasten/Anruferliste CLIP
- 5 Telefonbuch/Menü verlassen
- 6 Interne Gespräche
- 7 R-Signaltaste/Ein-Aus Mobilteil
- 8 Tastatursperre
- 9 Gesprächstaste
- 10 Stumm/Löschtaste

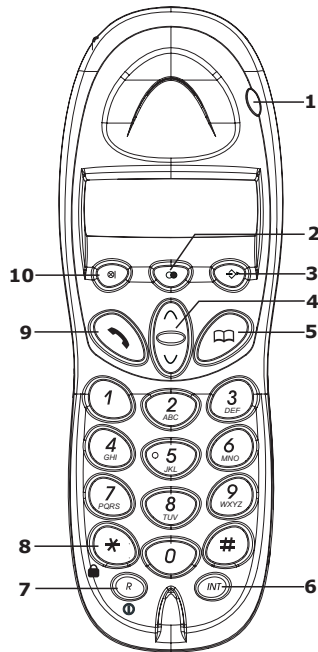

Basisstation

- 1 PAGE-Taste
- 2 Ladekontrollleuchte
- 3 Gesprächs- und Netzanzeige

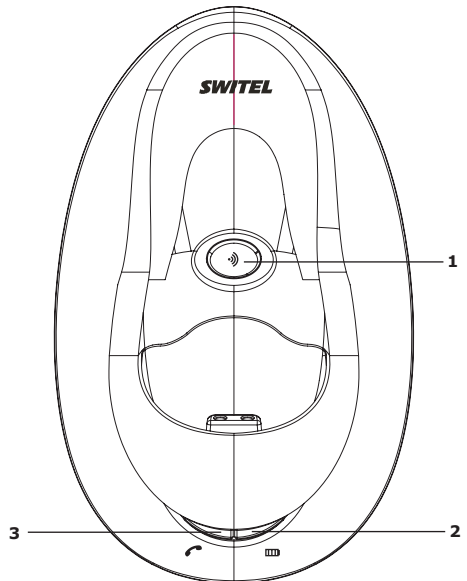

3 Inbetriebnahme

3.1 Sicherheitshinweise

ACHTUNG! Lesen Sie vor der Inbetriebnahme unbedingt die Sicherheitshinweise am Anfang dieser Bedienungsanleitung.

3.2 Verpackungsinhalt prüfen

Zum Lieferumfang gehören:

eine Basisstation	ein Stromanschlusskabel
ein Mobilteil	zwei Standard-Akkus
ein Telefonanschlusskabel	eine Bedienungsanleitung

3.3 Basisstation anschließen

Stellen Sie das Telefon in der Nähe Ihrer Telefonanschlussdose und einer Netzsteckdose auf.

1. Stecken Sie den Stecker des Netzteils in die Buchse auf der Unterseite der Basisstation und das Steckernetzteil in eine vorschriftsmäßig installierte Netzsteckdose mit 230V. Das Steckernetzteil der Basisstation muss immer angeschlossen sein. Verwenden Sie aus Sicherheitsgründen nur das mitgelieferte Steckernetzteil.
2. Verbinden Sie das beiliegende Telefonkabel mit der Telefonsteckdose und der Telefonbuchse auf der Unterseite der Basisstation. Verwenden Sie nur das neue beiliegende Telefonkabel.
3. Verlegen Sie die beiden Kabel durch die zwei Kabelkanäle zur Rückseite der Basisstation.

3.4 Standard-Akkus einbauen

Um die mitgelieferten wiederaufladbaren Standard-Akkus in das Mobilteil einzulegen, drücken Sie auf den Batteriefachdeckel am oberen Rand und schieben Sie ihn nach unten. Legen Sie nun die Standard-Akkus ein und achten Sie auf die richtige Polung. Schließen Sie den Batteriefachdeckel.

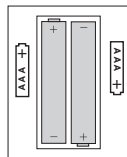

Wichtiger Hinweis: Stellen Sie das Mobilteil mit dem Display nach vorne für **mindestens 16 Stunden auf die Basisstation**. Bei nicht richtig geladenen Standard-Akkus kann es zu Fehlfunktionen des Telefons kommen. An der Basisstation leuchtet die Ladekontrollleuchte .

3.5 Aufladen der Standard-Akkus

Die wiederaufladbaren Standard-Akkus Ihres Telefons besitzen eine Standby-Zeit bei Zimmertemperatur von max. 100 Stunden und eine maximale Gesprächsdauer von bis zu 10 Stunden.

Die aktuelle Batteriekapazität wird im Display angezeigt:

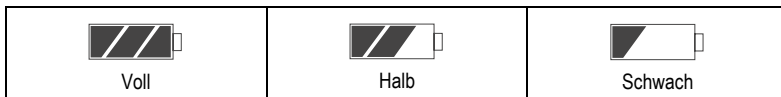

Ist die Batteriekapazität zu gering, blinkt das Symbol im Display, und Sie hören alle 60 Sekunden Warntöne.









Zum Laden der Standard-Akkus stellen Sie das Mobilteil mit dem Display nach vorne in die Basisstation.

Hinweis: Vor der ersten Inbetriebnahme müssen die Standard-Akkus für mindestens 16 Stunden geladen werden. Die aufladbaren Standard-Akkus unterliegen genau wie Ihre Autobatterie unvermeidlich einer gewissen Alterung. Allerdings können Sie auf diesen Alterungsprozess Einfluss nehmen, indem Sie die Standard-Akkus gewissermassen "trainieren". Wenn Sie bei regelmäßiger Benutzung Ihres Telefons die Standard-Akkus zyklisch aufladen und dann wieder "leer" telefonieren, bis die Anzeige  im Display erscheint, werden die Standard-Akkus gefordert und danken dies durch volle Leistungsfähigkeit und eine lange Lebensdauer. Dauerladung und Dauerentladung schaden dagegen sowohl der Kapazität wie auch der Lebensdauer der Standard-Akkus.

4 Bedienung



4.1 Das Display

Im normalen Betriebszustand zeigt das Display den Namen des Mobilteils an. Der voreingestellte Name kann jederzeit geändert werden. Siehe dazu 7.7. Das Display zeigt Ihnen weiterhin alle wichtigen Funktionen mit verschiedenen Symbolen an.

	Konstant: Sie führen ein Gespräch.
EXT	Konstant: Sie führen ein externes Gespräch. Blinkt: Es erreicht Sie ein externer Anruf.
INT	Konstant: Sie führen ein internes Gespräch. Blinkt: Es erreicht Sie ein interner Anruf.
	Konstant: Sie befinden sich in der Anruferliste (CLIP). Blinkt: Es sind neue Anrufe in der Anruferliste (CLIP) gespeichert.
	Konstant: Diese Rufnummer der Anruferliste nicht entgegengenommen.
	Konstant: Diese Rufnummer der Anruferliste wurde entgegengenommen.
	Blinkt: Bitte das Mobilteil laden. Konstant: Anzeige der Batteriekapazität Durchlaufen der Segmente: Das Mobilteil wird geladen.
	Konstant: Bei der Benutzung des Telefonbuchs.
	Konstant: Sobald die Programmierung aktiviert ist.
	Konstant: Die Tastatursperre ist eingeschaltet.
	Konstant: Die Verbindung zur Basisstation ist gut. Blinkt: Die Reichweite zur Basisstation ist überschritten.
	Konstant: Die Rufnummer ist länger als 12 Stellen.

4.2 Anrufe entgegennehmen

Erreicht Sie ein Anruf, ertönt der Tonruf am Mobilteil und an der Basisstation. Wegen der Funkübertragung klingelt das Mobilteil etwas später als die Basisstation. Im Display blinkt die Anzeige **EXT**. Drücken Sie die Gesprächstaste  am Mobilteil und die Verbindung wird hergestellt. Die Gesprächsanzeige der Basisstation blinkt während des Gesprächs.

Hinweis: Während das Mobilteil klingelt, können Sie mit den Tasten  und  die Ruftonlautstärke verändern. Um das Gespräch zu beenden, stellen Sie das Mobilteil zurück in die Basisstation oder drücken Sie die Gesprächstaste  am Mobilteil.





Hinweise: Informationen zur Anzeige der Rufnummern im Display entnehmen Sie bitte dem Kapitel 6.

Wenn die automatische Rufannahme eingeschaltet ist, wird der Anruf automatisch entgegengenommen, sobald Sie das Mobilteil von der Basisstation nehmen. Wie Sie die automatische Rufannahme ein- oder ausschalten, erfahren Sie im Kapitel 7.5.

4.3 Anrufe führen

1. Geben Sie die gewünschte Telefonnummer mit max. 32 Stellen über das Tastenfeld ein. Da das Display maximal 12 Zahlen anzeigen kann, werden bei längeren Telefonnummern nur die letzten 12 Zahlen angezeigt.





Hinweis: Haben Sie eine falsche Zahl eingegeben, können Sie durch mehrmaliges Drücken der Taste  die Telefonnummer löschen. Durch langes Drücken der Taste  wird die Rufnummer komplett gelöscht.

2. Drücken Sie die Gesprächstaste  und die gewünschte Verbindung wird hergestellt.

Hinweis: Sie können auch zuerst die Gesprächstaste  drücken und erhalten damit das Freizeichen. Durch Eingabe der Zahlen Ihrer gewünschten Rufnummer wählt Ihr Telefon die Rufnummer direkt an. Eine Korrektur einzelner Zahlen der Rufnummer, wie oben erwähnt, ist bei dieser Form des Gesprächsaufbaus nicht möglich.

4.4 Gespeicherte Rufnummern aus dem Telefonbuch anwählen

Nachdem Sie einige Telefonnummern gespeichert haben, können Sie diese sehr schnell und einfach abrufen.

1. Telefonbuchstaste  drücken. Das Display zeigt nun die erste gespeicherte Telefonnummer in alphabetischer Reihenfolge.
2. Mit den Tasten  und  können Sie nun alle gespeicherten Rufnummern anwählen. Um eine Rufnummer direkt alphabetisch auszuwählen, drücken Sie den entsprechenden Buchstaben.
3. Drücken Sie nun die Gesprächstaste  und die angezeigte Telefonnummer wird automatisch gewählt.

4.5 Anzeige der Gesprächsdauer



Während eines Gesprächs wird die Gesprächszeit im Display in Minuten und Sekunden angezeigt. 15 Sekunden nach dem Wählen wird im Display von Anzeige der gewählten Nummer auf Anzeige der Gesprächsdauer umgeschaltet. Nach Beendigung des Gesprächs bleibt die Anzeige noch für einige Sekunden im Display erhalten.

4.6 Mobilteil ein-/ausschalten

Durch längeres Festhalten der Taste  können Sie das Mobilteil ausschalten. Ist das Mobilteil ausgeschaltet, wird kein Batteriestrom verbraucht. Es können keine Gespräche empfangen werden.



Drücken Sie einmal die Taste , um das Mobilteil wieder einzuschalten. Das Display zeigt die Meldung **BASIS 1** und das Mobilteil ist nach kurzer Zeit wieder eingeschaltet. Sobald Sie das Mobilteil wieder auf die Basisstation stellen, schaltet sich dieses automatisch ein.

4.7 Hinweise zur Reichweite

Die Reichweite des Mobilteils beträgt ca. 50 Meter in geschlossenen Räumen und ca. 300 Meter im Freien. Bei einer guten Verbindung zur Basisstation leuchtet im Display das Symbol . Haben Sie sich zu weit von der Basisstation entfernt, blinkt das Symbol  und Sie hören Warntöne. Gehen Sie in diesem Fall wieder näher an die Basisstation, da ansonsten das Gespräch unterbrochen wird. Diese Warntöne lassen sich, wie im Kapitel 7.8 beschrieben, abschalten.



4.8 Mikrofon im Mobilteil stummschalten

Mit der Taste  können Sie während eines Telefongesprächs das Mikrofon des Mobilteils abschalten. So ist es möglich zu sprechen, ohne dass der Gesprächspartner Sie hört. Der Lautsprecher im Mobilteil bleibt eingeschaltet, und Sie können den Gesprächspartner weiterhin verstehen.

1. Drücken Sie einmal die Taste  während eines Gesprächs. Im Display erscheint die Anzeige **STUMM**.
2. Um das Mikrofon wieder einzuschalten, drücken Sie erneut die Taste . Die Anzeige **STUMM** erlischt und Sie können das Gespräch normal fortsetzen.





4.9 Einstellen der Hörerlautstärke

Ist Ihnen die Hörerlautstärke zu leise oder zu laut, können Sie diese Ihren Bedürfnissen anpassen.

Mit den Tasten  und  können Sie während eines Gesprächs die Lautstärke anpassen. Im Display wird die gewählte Lautstärke mit **HOERERLAUT 1 bis 5** angezeigt.

4.10 Wahlwiederholung





Die Wahlwiederholung nutzen Sie, wenn der angerufene Teilnehmer besetzt ist oder sich nicht meldet. Ihr Telefon speichert die fünf zuletzt gewählten Rufnummern.

1. Drücken Sie die Taste  und die zuletzt gewählte Telefonnummer wird im Display angezeigt.
2. Mit der Taste  können nun weitere Rufnummern der Wahlwiederholung angewählt werden. Mit der Taste  blättern Sie in der Liste wieder zurück.
3. Drücken Sie nun die Gesprächstaste  und die angezeigte Telefonnummer wird automatisch gewählt.

Hinweis: Ist eine Rufnummer der Wahlwiederholung im Telefonbuch gespeichert, erscheint automatisch der Name und nicht die Rufnummer im Display.



Rufnummer aus der Wahlwiederholung löschen

Um eine einzelne Rufnummer aus der Wahlwiederholung zu löschen, gehen Sie wie folgt vor:

1. Drücken Sie die Taste  und wählen Sie mit den Tasten  und  die Rufnummer der Wahlwiederholung, die gelöscht werden soll.
2. Drücken Sie die Taste  und das Display zeigt **LOESCHEN?**.
3. Bestätigen Sie mit der Menütaste  und die Rufnummer ist aus der Wahlwiederholung gelöscht.

Alle Rufnummern der Wahlwiederholung löschen

Um alle Rufnummern der Wahlwiederholung zu löschen, gehen Sie wie folgt vor:

1. Drücken Sie die Taste .
2. Halten Sie die Taste  solange gedrückt, bis das Display die Anzeige **ALLE LOESCH?** erscheint.
3. Bestätigen Sie mit der Menütaste  und die Rufnummer ist aus der Wahlwiederholung gelöscht.



4.11 Tastatursperre

Tragen Sie das Mobilteil öfter bei sich, können Sie die Tastatur sperren, damit nicht ungewollt Tasten gedrückt werden. Bei eingeschalteter Tastatursperre können eingehende Gespräche normal entgegengenommen werden.

Tastatursperre einschalten

Drücken Sie am Mobilteil für drei Sekunden die Taste  . Im Display erscheint das Symbol .

Tastatursperre ausschalten



Um die Tastatursperre aufzuheben, drücken Sie zweimal die Taste  .

Hinweis: Die Tastatursperre kann auch über das Menü eingeschaltet werden.

4.12 Temporäre Tonwahl

Können Sie Ihr Telefon nur mit dem IMPULS-Wahlverfahren betreiben, brauchen Sie nicht auf die Vorteile des TON-Wahlverfahren (z.B: Abfrage eines Anrufbeantworters) zu verzichten. Während eines Gesprächs können Sie mit der Taste  vorübergehend zum TON-Wahlverfahren wechseln. Nach Gesprächsende wird wieder auf das PULS-Wahlverfahren zurückgeschaltet.

4.13 Paging von der Basisstation zum Mobilteil

Wenn Sie sich nicht mehr erinnern können, wo Sie Ihr Mobilteil liegen gelassen haben, drücken Sie die Taste ) der Basisstation. Sie werden für 30 Sekunden die Tonsignale des Mobilteils hören und ihn so leicht wiederfinden. Mit einer beliebigen Taste am Mobilteil oder der Taste ) der Basisstation können Sie die Tonsignale vorher beenden.

4.14 Nebenstellenanlagen

Haben Sie Ihr Telefon mit einer Nebenstellenanlage verbunden, können Sie alle Möglichkeiten, wie z.B. Anrufe weiterleiten, automatischen Rückruf usw. nutzen. Die „R“ Signaltaste verschafft Ihnen den Zugang zu diesen Möglichkeiten. An einer Nebenstellenanlage wird die FLASH-Zeit "90ms" (FLASH 1, Werkseinstellung) oder „250ms“ (FLASH 2) benötigt (siehe Kapitel 7.11). Ob Ihr Telefon an Ihrer Nebenstellenanlage einwandfrei funktioniert, erfahren Sie bei dem Händler, bei dem die Anlage gekauft wurde.

4.15 Pause benutzen

Bei Nebenstellenanlagen ist es erforderlich, eine bestimmte Nummer zu wählen (z. B. "9" oder "0"), um ein Freizeichen für eine Amtsleitung auf den Apparat zu bekommen. Bei wenigen, älteren Nebenstellenanlagen dauert es einige Zeit bis das Freizeichen zu hören ist. Speziell für diese Nebenstellenanlagen kann nach der Amtsholung eine automatische Pause eingefügt werden, so dass Sie direkt weiter wählen können, ohne das Freizeichen abzuwarten.

Pause beim manuellen Wählen eingeben









Drücken Sie zwischen der Kennziffer für die Amtsholung und der eigentlichen Telefonnummer einmal die Wahlwiederholungstaste . Nach der Amtsholung wartet Ihr Telefon für 3 Sekunden mit dem Wählen der eigentlichen Telefonnummer.

Die Pause kann auch bei Rufnummern für das Telefonbuch mit gespeichert werden.

5 Das Telefonbuch

In das Telefonbuch können 30 Rufnummern inklusive eines Namens gespeichert werden. Die maximale Länge einer Rufnummer beträgt 20 Stellen.



5.1 Rufnummern in das Telefonbuch eingeben

1. Menütaste  drücken. Das Display zeigt die Meldung **TELEFONBUCH**.
2. Drücken Sie erneut die Taste . Das Display zeigt die Meldung **HINZUFUEGEN**.
3. Bestätigen Sie wieder mit der Menütaste . Das Display zeigt die Meldung **NAME ?**.
4. Geben Sie nun den zugehörigen Namen (max. 12 Buchstaben) über das Zahlenfeld ein. Hinweise zur Namenseingabe erhalten Sie im nächsten Abschnitt.
5. Bestätigen Sie den Namen der Menütaste . Das Display zeigt die Meldung **NUMMER?**.
6. Geben Sie die gewünschte Telefonnummer über das Zahlenfeld ein.
7. Bestätigen Sie wieder mit der Menütaste . Das Display zeigt die Meldung **MELODIE 1 - 3**.
8. Wählen Sie nun über die Auswahlstasten  und , welche Melodie Sie dieser Rufnummer zuordnen möchten.
9. Bestätigen Sie wieder mit der Menütaste . Das Display zeigt wieder die Meldung **HINZUFUEGEN**.
10. Möchten Sie weitere Rufnummern speichern, fahren Sie mit Punkt 3. fort. Durch Festhalten der Taste  verlassen Sie den Eingabemodus.

Hinweis zum Telefonbuch:

- Zusätzlich kann jeder gespeicherten Rufnummer eine der drei Rufnummelodien zugeordnet werden. Somit können Sie schon anhand der Rufnummelodie erkennen, wer Sie anruft. Diese Zuordnung funktioniert nur dann, wenn Ihr Telefonanschluss und auch der Anrufer über die Rufnummernanzeige CLIP verfügt.
- Geben Sie bei allen Rufnummern immer die Vorwahl mit ein, damit das Telefon auch eingehende Ortsgespräche einem Telefonbucheintrag zuordnen kann.
- Weitere Hinweise zur Rufnummernanzeige erhalten Sie im Kapitel 6.
- Ist die Speicherkapazität von 30 Rufnummern erreicht, zeigt das Display beim nächsten Speichern die Meldung **SPEICH VOLL**. Um wieder Platz zu schaffen, müssen zuerst wieder andere Rufnummern gelöscht werden.

TIP! Das Telefonbuch kann auch noch während eines Gesprächs angesehen werden. Drücken Sie dazu die Taste



 und wählen Sie wie gewohnt einen Eintrag aus. Die Menütaste  zeigt die gespeicherte Rufnummer (bei mehr als 12 Stellen zweimal drücken). Beim nochmaligen Betätigen der Menütaste  befinden Sie sich wieder im Telefonbuch.

Erklärung der Namenseingabe













Zur Eingabe des Namens sind die Zahlentasten mit Buchstaben beschriftet. Durch mehrmaliges Drücken der entsprechenden Taste können Grossbuchstaben sowie Zahlen eingegeben werden.

Beispiel: Sie möchten den Namen "Peter" eingeben.

Drücken Sie: 1 x Taste 7, 2 x Taste 3, 1 x Taste 8, 2 x Taste 3, 3 x Taste 7

- Um ein Leerzeichen einzugeben, drücken Sie einmal die Taste .
- Durch zweimaliges Drücken der Taste  kann zusätzlich ein Bindestrich eingegeben werden.
- Um den gleichen Buchstaben zweimal einzugeben, drücken Sie den entsprechenden Buchstaben und warten Sie dann bis der Cursor automatisch eine Stelle weiter springt.
- Falsche Eingaben können mit der Taste  gelöscht werden.

5.2 Gespeicherte Rufnummern im Telefonbuch ändern

1. Menütaste  drücken. Das Display zeigt **TELEFONBUCH**.
2. Drücken Sie erneut die Taste . Das Display zeigt **HINZUFUEGEN**.
3. Drücken Sie nun die Taste . Das Display zeigt **AENDERN**.
4. Bestätigen Sie wieder mit der Menütaste . Das Display zeigt nun in alphabetischer Reihenfolge die gespeicherten Rufnummern.
5. Wählen Sie jetzt über die Tasten  und  die Rufnummer aus, die Sie ändern möchten.
6. Bestätigen Sie die Auswahl mit der Menütaste . Das Display zeigt wiederum den Namen an. Zusätzlich blinkt hinter dem letzten Buchstaben der Cursor.
7. Ändern Sie nun den Namen über das Zahlenfeld ab. Hinweise zur Namenseingabe erhalten Sie im Kapitel 5.1.
8. Nachdem Sie die gewünschten Änderungen vorgenommen haben, bestätigen Sie wieder mit der Menütaste . Das Display zeigt nun die Rufnummer an.
9. Ändern Sie nun die Rufnummer über das Zahlenfeld ab. Durch mehrmaliges Drücken der Taste  werden die einzelnen Zahlen der Rufnummer gelöscht.
10. Nachdem Sie die gewünschten Änderungen vorgenommen haben, bestätigen Sie wieder mit der Menütaste . Das Display zeigt die Meldung **MELODIE**.
11. Wählen Sie nun über die Auswahlstasten  und , welche Melodie Sie dieser Rufnummer zuordnen möchten.
12. Nachdem Sie die gewünschten Änderungen vorgenommen haben, bestätigen Sie wieder mit der Menütaste . Das Display zeigt die Meldung **AENDERN**.
13. Möchten Sie weitere Rufnummern ändern, fahren Sie mit Punkt 4. fort. Durch Festhalten der Taste  verlassen Sie den Programmiermodus.

5.3 Gespeicherte Rufnummern aus dem Telefonbuch löschen

1. Menütaste  drücken. Das Display zeigt **TELEFONBUCH**.
2. Drücken Sie erneut die Taste . Das Display zeigt **HINZUFUEGEN**.
3. Drücken Sie nun die Taste . Das Display zeigt **LOESCHEN**.
4. Bestätigen Sie mit der Menütaste .
5. Wählen Sie jetzt über die Tasten  und  die Rufnummer aus, die Sie löschen möchten.
6. Nachdem Sie die gewünschte Rufnummer gefunden haben, bestätigen Sie mit der Menütaste  und das Display zeigt die Meldung **BESTAETIGEN?**. Durch das Festhalten der Taste  wird der Löschvorgang abgebrochen.
7. Bestätigen Sie wieder mit der Menütaste  und der Telefonbucheintrag ist gelöscht. Das Display zeigt wieder die Meldung **LOESCHEN**.
8. Haben Sie die Rufnummer gelöscht, erscheint im Display die Meldung **LOESCHEN**. Möchten Sie weitere Rufnummern löschen, fahren Sie mit Punkt 4. fort. Durch Festhalten der Taste  verlassen Sie den Löschmodus.

6 Rufnummernanzeige (CLIP)

In der Schweiz ist diese Funktion nicht bei jedem Netzanbieter verfügbar.

Mit der Rufnummernanzeige können Sie bei eingehenden Gesprächen erkennen, wer Sie anruft. Wenn diese Funktion an Ihrer Telefonleitung zur Verfügung steht, zeigt Ihnen das Display bereits die Rufnummer des Anrufers, wenn das Telefon klingelt. Hat der Anrufer das Senden seiner Rufnummer gesperrt oder kann die Rufnummer aus technischen Gründen nicht angezeigt werden, erscheinen die Displayanzeigen **VERWEIGERT** und **NICHT VERF** (nicht verfügbar).

Haben Sie diese Rufnummer in Ihrem Telefonbuch gespeichert, wird anstatt der Rufnummer der Name angezeigt. Zusätzlich kann im Telefonbuch jeder gespeicherten Rufnummer eine der drei Ruftonmelodien zugeordnet werden, so dass Sie schon an der Ruftonmelodie erkennen können, wer Sie anruft.

Alle Anrufe werden in einer Anruferliste gespeichert, so dass Sie auch während Ihrer Abwesenheit keinen Anruf verpassen werden. Insgesamt können 30 Rufnummern in der Liste gespeichert werden. Sobald die Liste voll ist, wird immer die älteste Rufnummer aus der Liste gelöscht. Werden während Ihrer Abwesenheit neue Rufnummern in der Anruferliste gespeichert, blinkt im Display das Symbol .





Achtung!

Die Rufnummernanzeige ist ein optionaler Service Ihres Telefonproviders. Ihr Telefon zeigt die Rufnummern im Display, wenn Ihr Telefonprovider diesen Service anbietet. Die Anzeige des Datums und der Uhrzeit wird nicht von allen Telefonprovidern übertragen. Bitte fragen Sie Ihren Telefonprovider nach weiteren Informationen. Auch bei manchen Nebenstellenanlagen ist eine Übertragung der Rufnummer oder auch des Datums und der Uhrzeit nicht möglich.

6.1 Die Anruferliste

Um die Rufnummern der Anruferliste im Display zu sehen, gehen Sie bitte wie folgt vor:

1. Drücken Sie die Taste  und die zuletzt empfangene Rufnummer wird im Display angezeigt. Ist die Anruferliste leer, zeigt das Display die Meldung **LEER**.
2. Mit den Tasten  und  können nun weitere Rufnummern der Anruferliste angewählt werden. Sind keine weiteren Rufnummern vorhanden, hören Sie einen Signalton. Zwei Displaysymbole informieren Sie, ob der Anruf entgegengenommen wurde oder nicht.



=> Dieser Anruf wurde nicht entgegengenommen.



=> Dieser Anruf wurde entgegengenommen.

Hinweise: Über die Menütaste  können Informationen abgerufen werden.

- Ist die Rufnummer länger als 12 Stellen, werden die restlichen Zahlen angezeigt.
- Zeigt die Rufnummer, wenn der Anrufer bereits mit Namen im Telefonbuch gespeichert ist.
- Zeigt das Datum und die Uhrzeit, wenn diese Daten vom Anrufer übertragen wurden.
- Stehen keine weiteren Daten zur Verfügung, zeigt das Display die Meldung **HINZUZUFUEGEN?**.











- Mit der Taste  können Sie wieder zur Liste zurückkehren.

3. Möchten Sie eine Rufnummer der Anruferliste direkt zurückrufen, drücken Sie einfach die Gesprächstaste  und die Nummer wird sofort angewählt.

4. Durch Festhalten der Taste  verlassen Sie die Anruferliste.







6.2 Rufnummer aus der Anruferliste in das Telefonbuch speichern

Eine in der Anruferliste gespeicherte Telefonnummer kann direkt in das Telefonbuch gespeichert werden.





1. Drücken Sie die Taste  und die zuletzt empfangene Rufnummer wird im Display angezeigt.
2. Mit den Taste  und  wählen Sie nun die Rufnummern der Anruferliste, die Sie in das Telefonbuch speichern möchten.
3. Drücken Sie die Taste , bis im Display die Meldung **HINZUZUFUEGEN?** erscheint.
4. Bestätigen Sie wieder mit der Menütaste . Das Display zeigt die Meldung **NAME?**.
5. Geben Sie nun den zugehörigen Namen (max. 12 Buchstaben) über das Zahlenfeld ein.
6. Bestätigen Sie wieder mit der Menütaste  und die Rufnummer wird im Display noch einmal angezeigt.
7. Bestätigen Sie wieder mit der Menütaste . Das Display zeigt die Meldung **MELODIE 1 - 3**.
8. Wählen Sie nun über die Auswahlstasten  und , welche Melodie Sie dieser Rufnummer zuordnen möchten.
9. Bestätigen Sie wieder mit der Menütaste  und die Rufnummer ist im Telefonbuch gespeichert.

Hinweis: Sobald die Rufnummer im Telefonbuch mit einem Namen gespeichert wurde, erscheint in der Anruferliste nicht mehr die Telefonnummer, sondern der eingegebene Name.

6.3 Einzelne Rufnummer aus der Anruferliste löschen



1. Drücken Sie die Taste  und die zuletzt empfangene Rufnummer wird im Display angezeigt.
2. Mit den Tasten  und  wählen Sie nun die Rufnummern der Anruferliste, die Sie löschen möchten.
3. Drücken Sie die Taste . Das Display zeigt die Meldung **LOESCHEN ?**.
4. Bestätigen Sie wieder mit der Menütaste  und die Rufnummer ist aus der Anruferliste gelöscht oder verlassen Sie den Löschmodus durch Festhalten der Taste .

6.4 Komplette Anruferliste löschen

1. Drücken Sie die Taste  und die zuletzt empfangene Rufnummer der Anruferliste wird im Display angezeigt.
2. Halten Sie die Taste  gedrückt, bis im Display die Meldung **ALLE LOESCH?** erscheint.
3. Bestätigen Sie wieder mit der Menütaste  um die Anruferliste zu löschen oder verlassen Sie den Löschmodus durch Festhalten der Taste .



7 Sonderfunktionen

Alle weiteren Programmierfunktionen sind über ein sehr benutzerfreundliches Menü zu erreichen. Hier eine kleine allgemeine Anleitung, wie Sie sich im Menü zurechtfinden können:

Mit der Taste  wird die Programmierung gestartet. Während der Programmierung leuchtet die Anzeige  im Display.

Mit den Tasten  und  können Sie die gewünschte Ebene aussuchen.

Mit der Taste  wird diese Ebene geöffnet.

Mit den Tasten  und  können Sie dann wieder die gewünschte Funktion aussuchen, um dann wieder mit der Menütaste  zu bestätigen.

Mit der Taste  gelangen Sie jeweils eine Ebene zurück.











Jeder Speichervorgang wird automatisch abgebrochen, wenn innerhalb von 15 Sekunden keine Eingabe erfolgt.

Durch Festhalten der Taste  können Sie die Programmierung jederzeit wieder verlassen, ohne Änderungen vorzunehmen.

Im Kapitel 7.13 erhalten Sie eine komplette Übersicht des Menüs.











7.1 Rufsignale am Mobilteil einstellen (Klingelmelodien)

Ihr Mobilteil kann sich mit drei verschiedenen Tonruf-Melodien melden, wenn Sie ein Anruf erreicht. Betreiben Sie das Telefonsystem mit mehreren Mobilteilen, können Sie für externe und interne Anrufe unterschiedliche Melodien einstellen.

1. Drücken Sie die Menütaste .
2. Mit  und  das Menü **MOBILTEIL** wählen und mit  bestätigen.
3. Mit  und  die Funktion **EXT MELODIE** (Tonruf bei externen Anrufen) oder **INT MELODIE** (Tonruf bei internen Anrufen/nur bei zwei Mobilteilen) wählen und mit  bestätigen.
4. Mit  und  die gewünschte Melodie auswählen und mit  bestätigen.
5. Wählen Sie nun weitere Menüfunktionen oder verlassen Sie das Menü durch Festhalten der Taste .

7.2 Lautstärke des Tonrufs am Mobilteil











Die Lautstärke des Tonrufs am Mobilteil kann in drei Stufen eingestellt werden. Möchten Sie einmal nicht gestört werden, können Sie den Tonruf auch ganz abschalten. Ist der Tonruf ausgeschaltet, werden eingehende Anrufe nur noch an der Basisstation und über das Display am Mobilteil signalisiert.

1. Drücken Sie die Menütaste .
2. Mit  und  das Menü **MOBILTEIL** wählen und mit  bestätigen.
3. Mit  und  die Funktion **EXT RUF LAUT** (Lautstärke bei externen Anrufen) oder **INT RUF LAUT** (Lautstärke bei internen Anrufen/nur bei zwei Mobilteilen) wählen und mit  bestätigen.
4. Mit  und  die gewünschte Lautstärke wählen oder den Tonruf mit **TON AUS** abschalten und mit  bestätigen.
5. Wählen Sie nun weitere Menüfunktionen oder verlassen Sie das Menü durch Festhalten der Taste .

- **Sonderfunktionen** -











7.3 Rufsignale an der Basisstation einstellen (Klingelmelodien)

Auch die Basisstation kann sich mit drei verschiedenen Tonruf-Melodien melden, wenn Sie ein Anruf erreicht.

1. Drücken Sie die Menütaste .
2. Mit  und  das Menü **EINSTELLUNG** wählen und mit  bestätigen.
3. Mit  und  die Funktion **BASIS MELODY** wählen und mit  bestätigen.
4. Mit  und  die gewünschte Melodie auswählen und mit  bestätigen.
5. Wählen Sie nun weitere Menüfunktionen oder verlassen Sie das Menü durch Festhalten der Taste .

7.4 Lautstärke des Tonrufs an der Basisstation











Die Lautstärke des Tonrufs an der Basisstation kann in drei Stufen eingestellt werden. Möchten Sie einmal nicht gestört werden, können Sie den Tonruf auch ganz abschalten.

1. Drücken Sie die Menütaste .
2. Mit  und  das Menü **EINSTELLUNG** wählen und mit  bestätigen.
3. Mit  und  die Funktion **BASIS LAUTST** wählen und mit  bestätigen.
4. Mit  und  die gewünschte Lautstärke wählen oder den Tonruf mit **TON AUS** abschalten und mit  bestätigen.
5. Wählen Sie nun weitere Menüfunktionen oder verlassen Sie das Menü durch Festhalten der Taste .

7.5 Anrufe automatisch entgegennehmen











Eingehende Anrufe werden automatisch entgegengenommen, wenn Sie das Mobilteil von der Basisstation nehmen.

Möchten Sie, dass Anrufe nur über die Taste  entgegengenommen werden, können Sie die automatische Annahme ausschalten.

1. Drücken Sie die Menütaste .
2. Mit  und  das Menü **MOBILTEIL** wählen und mit  bestätigen.
3. Mit  und  die Funktion **AUTO ANNAHME** wählen und mit  bestätigen.
4. Mit  und  **EIN** oder **AUS** wählen und mit  bestätigen.
5. Wählen Sie nun weitere Menüfunktionen oder verlassen Sie das Menü durch Festhalten der Taste .

7.6 Ton (MFV)- oder Impuls (IWW) - Wahlverfahren











Dieses Merkmal ermöglicht Ihnen Ihr Telefon sowohl an den analogen Vermittlungsstellen (IWW/IMPULS) als auch an den neuen digitalen Vermittlungsstellen (MFV/TON) zu betreiben. Als Werkseinstellung ist das MFV/TON-Wahlverfahren eingestellt.

1. Drücken Sie die Menütaste .
2. Mit  und  das Menü **EINSTELLUNG** wählen und mit  bestätigen.
3. Mit  und  die Funktion **MFV-IWW** wählen und mit  bestätigen.
4. Mit  und  das gewünschte Wahlverfahren wählen und mit  bestätigen.
5. Wählen Sie nun weitere Menüfunktionen oder verlassen Sie das Menü durch Festhalten der Taste .

7.7 Displaynamen ändern

Im normalen Betrieb erscheint im Display die Anzeige „D6025“. Haben Sie mehrere Mobilteile an einer Basisstation angemeldet, kann es nützlich sein, jedem Mobilteil einen eigenen Namen zu geben. Die Nummer hinter dem Namen zeigt, mit welcher Nummer das Mobilteil intern zu erreichen ist.

- Sonderfunktionen -

1. Drücken Sie die Menütaste .
2. Mit  und  das Menü **MOBILTEIL** wählen und mit  bestätigen.
3. Mit  und  die Funktion **NAME** wählen und mit  bestätigen.
4. Geben Sie über das Zahlenfeld den gewünschten Namen ein. Durch mehrmaliges Drücken der Taste  werden bereits eingegebene Buchstaben gelöscht.
5. Bestätigen Sie mit .
6. Wählen Sie nun weitere Menüfunktionen oder verlassen Sie das Menü durch Festhalten der Taste .

7.8 Hinweistöne ein-/ausschalten

Hier können verschiedene Warntöne ein- oder ausgeschaltet werden.

Tastenklick















Jeder Tastendruck wird vom Mobilteil mit einem Tastenklick bestätigt. Der Tastenklick kann ein- oder ausgeschaltet werden.

Warnton bei zu geringer Batteriekapazität

Bei zu geringer Batteriekapazität erinnert Sie ein Warnton, dass Sie das Mobilteil laden müssen.

Reichweitenwarnung

Haben Sie sich zu weit von der Basisstation entfernt, erinnert Sie ein Warnton, dass Sie den Kontakt zur Basisstation verlieren werden.

1. Drücken Sie die Menütaste .
2. Mit  und  das Menü **MOBILTEIL** wählen und mit  bestätigen.
3. Mit  und  die Funktion **TOENE** wählen und mit  bestätigen.
4. Mit  und  eine der Funktionen **TASTENTON**, **AKKU LEER** oder **REICHWEITE** wählen und mit  bestätigen.
5. Mit  und  den gewählten Warnton ein- oder ausschalten und mit  bestätigen.
6. Wählen Sie nun weitere Menüfunktionen oder verlassen Sie das Menü durch Festhalten der Taste .

7.9 PIN-Code ändern

Einige Funktionen des Telefonsystems werden mit einem PIN Code vor unerlaubter Benutzung geschützt. Der PIN-Code besteht aus vier Zahlen. Im Lieferzustand wurde der PIN-Code „0000“ eingestellt. Um den PIN-Code zu ändern gehen Sie wie folgt vor:

1. Drücken Sie die Menütaste .
2. Mit  und  das Menü **EINSTELLUNG** wählen und mit  bestätigen.
3. Mit  und  die Funktion **PIN CODE** wählen und mit  bestätigen.
4. Geben Sie nun den aktuellen, vierstelligen PIN-Code über das Zahlenfeld ein (Werkseinstellung 0 0 0 0) und bestätigen Sie mit .
5. Geben Sie nun den neuen, vierstelligen PIN-Code über das Zahlenfeld ein und bestätigen Sie mit .
6. Geben Sie nun den neuen, vierstelligen PIN-Code zur Bestätigung erneut ein und bestätigen Sie mit .
7. Wählen Sie nun weitere Menüfunktionen oder verlassen Sie das Menü durch Festhalten der Taste .









Wird der alte Pin-Code nicht richtig eingegeben, wird der Vorgang abgebrochen.

7.10 Displaysprache einstellen

Die Displayanzeigen sind in den Sprachen Deutsch, Italienisch, Spanisch, Niederländisch, Englisch, Französisch und Dänisch/Norwegisch/Schwedisch einstellbar.

1. Drücken Sie die Menütaste .
2. Mit  und  das Menü **MOBILTEIL** wählen und mit  bestätigen.
3. Mit  und  die Funktion **SPRACHE** wählen und mit  bestätigen.
4. Mit  und  eine Sprache wählen und mit  bestätigen.
5. Durch Festhalten der Taste  verlassen Sie den Eingabemodus.









7.11 FLASH-Zeit einstellen

1. Drücken Sie die Menütaste .
2. Mit  und  das Menü **EINSTELLUNG** wählen und mit  bestätigen.
3. Mit  und  die Funktion **FLASHZEIT** wählen und mit  bestätigen.
4. Mit  und  die Flashzeit **FLASH 1** (90ms) oder **FLASH 2** (250ms) wählen und mit  bestätigen.
5. Durch Festhalten der Taste  verlassen Sie den Eingabemodus.





7.12 Werkseinstellungen wieder herstellen

Mit dieser Funktion werden das Mobilteil und die Basisstation wieder auf die Werkseinstellungen zurückgesetzt. Das Telefonbuch, die Anruferliste (CLIP) und alle Rufnummern der Wahlwiederholung werden gelöscht.

Sprache: Deutsch	Name Mobilteil: D6025
Warnton Batterie: Ein	Automatische Rufannahme ein
Warnton Reichweite: Ein	Tonrufmelodie extern: 3
Tastenklick: Ein	Tonrufmelodie intern: 1
Hörerlautstärke: 3	Tonrufflautstärke Mobilteil: 3
Pin Code: 0 0 0 0	Tonrufmelodie Basis : 2
Pause: 3 Sek.	Tonrufflautstärke Basis : 3
Wahlverfahren: MFV/Ton	FLASH-Zeit: 90ms

1. Drücken Sie die Menütaste .
2. Mit  und  das Menü **EINSTELLUNG** wählen und mit  bestätigen.
3. Mit  und  die Funktion **WERKEINST** wählen und mit  bestätigen.
4. Über das Zahlenfeld den PIN Code eingeben (Werkseinstellung 0000) und mit  bestätigen. Es erscheint die Displaymeldung **BESTAETIGEN?**.
5. Bestätigen Sie mit der Menütaste .
6. Nach kurzer Zeit sind die Werkseinstellungen wieder hergestellt. Das Display zeigt wieder den Bereitschaftsmodus an.

Hinweis: Haben Sie den PIN Code vergessen, können Sie die Werkseinstellungen auch ohne den PIN Code wieder einstellen.

1. Nehmen Sie eine Batterie aus dem Mobilteil.
2. Halten Sie die Taste  gedrückt und legen Sie die Batterie wieder ein. Halten Sie die Taste  solange gedrückt, bis im Display die Meldung **WERKEINST** erscheint.
3. Bestätigen Sie mit  und die Werkseinstellungen werden wieder hergestellt. Mit der Taste  können Sie den Vorgang abbrechen.

- Sonderfunktionen -

7.13 Menüstruktur

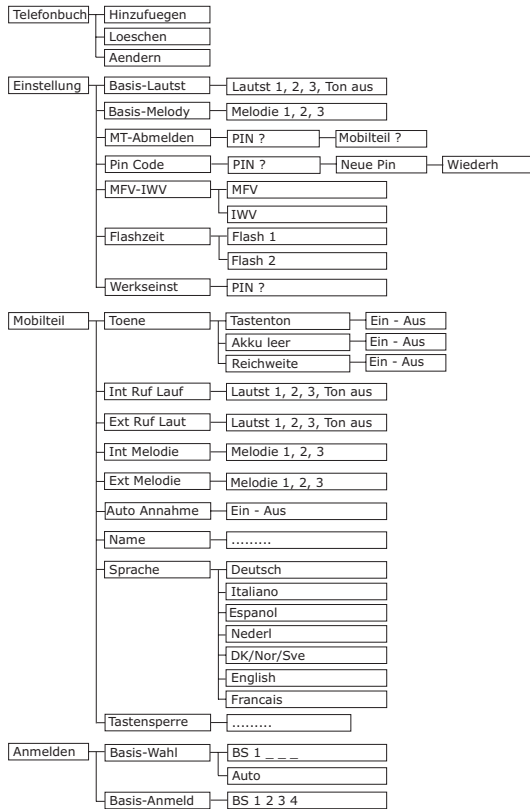

8 Mehrere Mobilteile

Es kann ein weiteres Mobilteil an Ihre Basisstation angemeldet werden.

Hinweis: Über den international genormten GAP Standard können SWITEL und auch Mobilteile von Fremdherstellern in das Telefonsystem integriert werden. Genauso können Sie ein SWITEL Mobilteil an Basisstationen anderer Hersteller anschließen, sofern diese Geräte mit dem GAP Standard arbeiten.



Bei der Benutzung von mehreren Mobilteilen erhalten Sie folgende Möglichkeiten:

- Interne Gespräche zwischen den Mobilteilen.
- Externe Gespräche können zwischen den Mobilteilen weitergeleitet werden.
- Eingehende externe Gespräche werden an allen Mobilteilen signalisiert.



Achtung! Benutzt bereits ein anderes Mobilteil die externe Leitung, leuchtet an allen Mobilteilen die Kontrollleuchte am Hörer. Ein weiteres externes Gespräch ist in diesem Fall nicht möglich.

8.1 Intern telefonieren

Sobald Sie mehrere Mobilteile an eine Basisstation angeschlossen haben, können Sie interne Gespräche führen.

Drücken Sie dazu die Taste  und dann die Nummer 1 oder 2 des gewünschten Mobilteils. Das Gespräch wird mit der Gesprächstaste  am gerufenen Mobilteil entgegengenommen.

8.2 Externe Gespräche auf ein anderes Mobilteil verbinden











Haben Sie ein externes Gespräch an einem Mobilteil entgegengenommen, können Sie das externe Gespräch auf ein anderes Mobilteil weiterverbinden. Drücken Sie dazu die Taste  und dann die Nummer (1 oder 2) des gewünschten Mobilteils. Sollte sich das gerufene Mobilteil nicht melden, können Sie das Gespräch mit der Taste  wieder zurückholen. Nachdem das interne Gespräch an dem anderen Mobilteil entgegengenommen wurde, haben Sie folgende Möglichkeiten:

A. Rücksprache / Makeln: Sie können nun mit dem internen Teilnehmer sprechen, und durch das Drücken der Taste  zum externen Gesprächspartner zurückkehren. Sie können so beliebig oft, zwischen dem externen und internen Gespräch wechseln.

B. Gespräch weiterleiten: Durch das Drücken der Gesprächstaste  am ersten Mobilteil, wird das externe Gespräch an das gerufene Mobilteil weitergeleitet.

8.3 An- und abmelden von Mobilteilen

8.3.1 Anmelden von Mobilteilen

1. Halten Sie die Pagetaste  der Basisstation für 6 Sekunden gedrückt, bis Sie zwei Signaltöne hören. Melden Sie das neue Mobilteil nun innerhalb von 90 Sekunden an die Basisstation an.
2. Drücken Sie die Taste  am Mobilteil.
3. Mit  und  das Menü **ANMELDEN** wählen und mit der Taste  bestätigen.
4. Mit  und  das Menü **BASIS ANMELD** wählen und mit der Taste  bestätigen.
5. Geben Sie nun über das Zahlenfeld die Nummer der Basisstation ein (1 – 4). Ist das Mobilteil bereits mit einer Basisstation verbunden, blinken die entsprechenden Nummern.
6. Bestätigen Sie Ihre Eingabe mit der Taste . Die Basisstation wird nun gesucht.
7. Nachdem die Basisstation gefunden wurde müssen Sie den PIN-Code der Basisstation (Werkseinstellung 0 0 0) eingeben.
8. Bestätigen Sie Ihre Eingabe mit der Taste  und Sie hören nach einigen Sekunden einen Signalton. Das Mobilteil ist nun angemeldet und kann für externe und interne Gespräche benutzt werden.
9. Dem Mobilteil wurde nun automatisch eine interne Rufnummer vergeben. Das bereits angemeldete Hauptmobilteil hat die interne Nummer 1. Das zweite angemeldete Mobilteil erhält die interne Rufnummer 2. Diese interne Rufnummer wird im Display rechts neben dem Namen angezeigt.











- Mehrere Mobilteile -

8.3.2 Anmelden von anderen DECT-GAP Telefonen an die Basisstation

Um ein DECT-GAP Mobilteil anzumelden, folgen Sie den Hinweisen in der Bedienungsanleitung des Fremderstellers und drücken dann die Taste  an der Basisstation für 6 Sekunden. Benutzen Sie zur Anmeldung den PIN-Code 0 0 0 0.

8.3.3 Abmelden von Mobilteilen

Ein Mobilteil kann nur über ein anderes, noch angemeldetes Mobilteil abgemeldet werden. Es ist also nicht möglich diese Abmeldung mit dem Mobilteil durchzuführen, das abgemeldet werden soll.











1. Drücken Sie die Taste  am Mobilteil.
2. Mit  und  das Menü **EINSTELLUNGEN** wählen und mit der Taste  bestätigen.
3. Mit  und  die Funktion **MT-ABMELDEN** wählen und mit der Taste  bestätigen.
4. Geben Sie nun den PIN-Code der Basisstation (Werkseinstellung 0 0 0 0) ein und bestätigen Sie mit der Taste .
5. Wählen Sie nun die Nummer des abzumeldenden Mobilteiles 1 oder 2 und bestätigen Sie mit der Taste . Mit der Taste  können Sie den Vorgang abbrechen. Bei erfolgreicher Abmeldung hören Sie nach einigen Sekunden einen Signalton. Das Mobilteil ist nun abgemeldet und kann für externe und interne Gespräche nicht mehr benutzt werden.

8.4 Zusätzliche Basisstationen

Bei der Verwendung von mehreren Basisstationen können Sie die Reichweite des Mobilteiles vergrößern. Um diesen Effekt zu nutzen, müssen alle Basisstationen mit einem Telefonanschluss verbunden sein. Je nach Verwendungszweck können Sie jede Basisstation mit der gleichen Telefonnummer belegen oder geben Sie den Basisstationen unterschiedliche Rufnummern. Achten Sie darauf, dass sich alle Basisstationen in ihrer Reichweite überschneiden. Jedes Mobilteil muss an jede Basisstation angemeldet werden. Bitte testen Sie vor jeder Inbetriebnahme einer neuen Basisstation die Reichweite des Mobilteiles.

Ist ein Mobilteil an den Basisstationen angemeldet, und wurde die automatische Wahl der Basisstation eingeschaltet (weitere Informationen in diesem Kapitel), wird das Mobilteil immer automatisch an die nächste Basisstation weitergeleitet. **Laufende Gespräche können nicht** von einer zur anderen Basisstation übertragen werden.

Wählen einer Basisstation

1. Drücken Sie die Taste  am Mobilteil.
2. Mit  und  das Menü **ANMELDEN** wählen und mit der Taste  bestätigen.
3. Mit  und  das Menü **BASIS WAHL** wählen und mit der Taste  bestätigen.
4. Das Display zeigt nun alle Basisstationen, an denen das Mobilteil bereits angemeldet wurde. Die Nummer der geraden aktiven Basisstation blinkt. Wählen Sie über das Zahlenfeld die gewünschte Basisstation, auf die das Mobilteil umgeschaltet werden soll.
Oder wechseln Sie mit den Tasten  und  auf die Einstellung **AUTO**. Bei dieser Einstellung wechselt das Mobilteil automatisch zur nächsten Basisstation, wenn die Verbindung zur aktuellen Basisstation zu schwach wird.
5. Bestätigen Sie mit der Taste .

9 Fehlerbeseitigung

Haben Sie Probleme mit Ihrem Telefon, kontrollieren Sie bitte die folgenden Hinweise.

Bei Garantieansprüchen wenden Sie sich bitte an Ihren Fachhändler. Die Garantiezeit beträgt 2 Jahre. Für die wiederaufladbaren Batterien gilt eine Garantiezeit von 12 Monaten.

Kein Telefongespräch möglich	Die Telefonleitung ist nicht korrekt angeschlossen oder gestört. Verwenden Sie nur das mitgelieferte Telefonkabel. Testen Sie mit einem anderen Telefon, ob Ihr Telefonanschluss in Ordnung ist. Das Steckernetzteil ist nicht eingesteckt oder es liegt ein totaler Stromausfall vor. Die aufladbaren Standard-Akkus sind leer oder defekt. Sie haben sich zu weit von der Basisstation entfernt.
Verbindung abgehackt, fällt aus	Sie haben sich zu weit von der Basisstation entfernt. Falscher Aufstellungsort der Basisstation.
Keine Wahl möglich	Wahlverfahren falsch eingestellt (siehe Kapitel 7.6).
Das System reagiert nicht mehr oder befindet sich in einem undefinierten Zustand.	Setzen Sie alle Funktionen in den Werkzustand zurück. Ziehen Sie vorher kurzzeitig das Steckernetzteil aus der Steckdose. Werkseinstellung siehe Kapitel 7.12.
Die Ladekontrollleuchte leuchtet nicht.	Stellen Sie das Mobilteil richtig auf die Basisstation, reinigen Sie die Kontaktflächen am Mobilteil und an der Basisstation mit einem weichen, trockenen Tuch.
Im Display blinkt nach ein paar Stunden das Batterie-Symbol.	Legen Sie das Mobilteil für 16 Stunden auf die Basisstation. Hilft dies nicht, erneuern Sie die aufladbaren Standard-Akkus .
Display-Anzeige dunkel	Verursacht durch direkte Sonnenbestrahlung, Mobilteil abkühlen lassen.

10 Technische Daten

Standard	DECT-GAP
Kanalzahl	1880 bis 1990 MHz
Stromversorgung	Basisstation 220/230V, 50 Hz
Reichweite	Innen bis zu 50m
Reichweite	Aussen bis zu 300m
Standby	bis zu 100 Stunden
Max. Gesprächsdauer	bis zu 10 Stunden
Aufladbare Standard-Akkus	2 x 1,2V/550mAh, Typ AAA
Wählverfahren	MFV oder IWW
Zulässige Umgebungstemperatur	10°C bis 30°C
Zulässige relative Luftfeuchtigkeit	20 bis 75%
Signalstastenfunktion	90ms oder 250ms

- Sommaire -

1	Remarques générales.....	24	6	Affichage des numéros de téléphone (CLIP)	33
2	Éléments de commande.....	25	6.1	La liste des appelants.....	33
3	Mise en service	26	6.2	Enregistrer dans le répertoire des numéros de téléphone de la liste des appelants	34
3.1	Consignes de sécurité	26	6.3	Effacer des numéros de téléphone de la liste des appelants	34
3.2	Contrôler le contenu de l'emballage ...	26	6.4	Effacer entièrement la liste des appelants	34
3.3	Raccorder la base.....	26	7	Fonctions spéciales	35
3.4	Remplacer des batteries	26	7.1	Régler les signaux de sonnerie sur le combiné (mélodies de sonnerie).....	35
3.5	Charge des batteries	26	7.2	Volume de la sonnerie du combiné	35
4	Utilisation.....	27	7.3	Régler les signaux de sonnerie sur la base (mélodie de sonnerie)	36
4.1	L'écran	27	7.4	Volume de la sonnerie de la base	36
4.2	Répondre aux appels.....	27	7.5	Réception automatique des appels	36
4.3	Appeler	28	7.6	Mode tonalités (MFV) ou impulsions (IWV)	36
4.4	Composer les numéros de téléphone enregistrés dans le répertoire	28	7.7	Modifier les noms d'écran.....	37
4.5	Affichage de la durée de communication.....	28	7.8	Activer/désactiver les signaux sonores d'indication.....	37
4.6	Activer / désactiver le combiné	28	7.9	Modifier le code PIN	37
4.7	Indications concernant la portée.....	28	7.10	Régler la langue d'affichage à l'écran	38
4.8	Désactiver le micro du combiné.....	29	7.11	Régler la durée de FLASH	38
4.9	Réglages du volume de l'écouteur	29	7.12	Rétablir les réglages par défaut.....	38
4.10	Rappel du dernier numéro composé	29	7.13	Structure du menu	39
4.11	Verrouillage du clavier	30	8	Plusieurs combinés.....	40
4.12	Mode tonalités temporaire	30	8.1	Communications internes	40
4.13	Paging de la base vers le combiné	30	8.2	Transférer les appels externes sur un autre combiné.....	40
4.14	Autocommutateurs.....	30	8.3	Déclaration et annulation de la déclaration de combinés.....	40
4.15	Utiliser une pause	30	8.3.1	Déclaration de combinés.....	40
5	Le répertoire	31	8.3.2	Déclaration d'autres téléphones DECT-GAP à la base	41
5.1	Entrer des numéros de téléphone dans le répertoire	31	8.3.3	Annuler la déclaration de combinés.....	41
5.2	Modifier des numéros de téléphone du répertoire	32	8.4	Bases supplémentaires	41
5.3	Effacer des numéros de téléphone du répertoire	32	9	Suppression des erreurs	42
			10	Caractéristiques techniques.....	42

1 Remarques générales

Batteries rechargeables - Ne pas utiliser d'autres batteries rechargeables ou blocs de batterie, qui risqueraient éventuellement de provoquer un court-circuit. Pour le remplacement, utilisez toujours uniquement des batteries rechargeables de type AAA 1.2 volts, 550mA. Ne pas jeter les batteries au feu, ni les plonger dans l'eau. Ne pas jeter les batteries usées ou défectueuses aux ordures ménagères. Le réchauffement du combiné se produisant éventuellement lors de sa charge est normal et sans danger. Ne chargez pas le combiné à l'aide de chargeurs d'autres marques car cela risquerait de provoquer des détériorations.

Lieu d'installation - Le lieu d'installation doit être pourvu d'une prise de courant 230 volts. N'installez pas la base à proximité directe d'autres appareils électroniques tels que les fours à micro-ondes ou les chaînes hi-fi car cela pourrait provoquer des perturbations mutuelles. Le lieu d'installation a une grande influence sur le fonctionnement correct du téléphone. Placez la base sur une surface plane et antidérapante. Normalement, les pieds de la base ne laissent pas de trace sur la surface du support. La multitude de vernis et de surfaces existants ne permet cependant pas d'exclure l'éventualité de traces laissées par les pieds de l'appareil sur la surface sur laquelle il est posé. N'utilisez pas le combiné dans des zones à atmosphère explosive. Évitez une exposition excessive à la fumée, à la poussière, aux secousses, à des substances chimiques, à l'humidité, à la chaleur ou l'exposition directe au soleil.

Conseil d'ordre médical - Le téléphone fonctionne avec une très faible puissance d'émission. Selon le niveau actuel de la recherche et de la technique, cette faible puissance d'émission permet d'exclure une atteinte à la santé. Il a cependant été démontré que les téléphones portables allumés peuvent perturber des appareils médicaux. Respectez en conséquence une distance minimale d'un mètre par rapport aux appareils médicaux.

Élimination - Lorsque les batteries rechargeables ou l'équipement entier arrivent en fin de vie, veuillez les éliminer de manière non polluante conformément aux dispositions légales.

Température et conditions ambiantes - Le téléphone est conçu pour une utilisation dans des locaux abrités et pour une plage de température de 10 °C à 30 °C. La base ne doit pas être installée dans des pièces humides telles que salle de bains ou buanderie. Évitez de placer l'appareil à proximité de sources de chaleur telles que les radiateurs et évitez une exposition directe au soleil.

Nettoyage et entretien - Vous pouvez utiliser un chiffon sec, doux et non pelucheux pour nettoyer les surfaces du boîtier. N'utilisez jamais de produit d'entretien, voire de solvants agressifs. Aucun entretien n'est nécessaire hormis le nettoyage du boîtier de temps en temps. Les pieds en caoutchouc de la base ne résistent pas à tous les produits d'entretien. Par conséquent, le fabricant ne pourra être tenu responsable d'éventuelles détériorations survenant aux meubles ou autres.

2 Éléments de commande

Combiné

- 1 Voyant de communication
- 2 Rappel du dernier numéro composé
- 3 Touche de menu
- 4 Touche de communication
- 5 Touches de sélection/
La liste des appelants (CLIP)
- 6 Communications internes
- 7 Touche de signal R
- 8 Répertoire
- 9 Touche secret/d'effacement

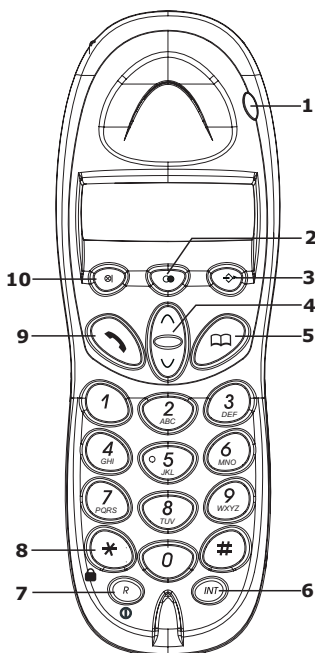

Base

- 1 Touche PAGE
- 2 Voyant de contrôle de charge
- 3 Voyant de communication et
de raccordement au réseau

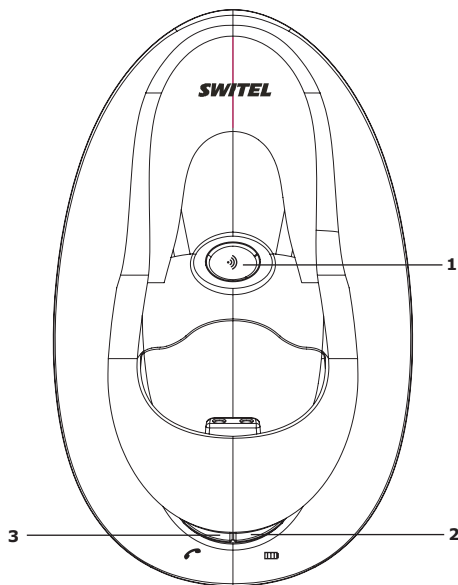

3 Mise en service

3.1 Consignes de sécurité

ATTENTION ! Veuillez impérativement lire, avant la mise en service, les remarques générales faites au début du présent mode d'emploi.

3.2 Contrôler le contenu de l'emballage

Le contenu de l'emballage :

Une base	Un cordon d'alimentation électrique
Un combiné avec batteries	Clip ceinture
Un cordon téléphonique	Un mode d'emploi

3.3 Raccorder la base

Installez le téléphone à proximité d'une prise téléphonique et d'une prise de courant.

1. Enfoncez la fiche du bloc d'alimentation dans la prise située sur la face inférieure de la base et le bloc d'alimentation dans une prise de courant de 230 V installée conformément aux dispositions réglementaires. Le bloc d'alimentation de la base doit toujours être raccordé. Pour des raisons de sécurité, utilisez uniquement le bloc d'alimentation fourni.
2. Relevez le cordon téléphonique fourni à la prise téléphonique et à la prise située sur la face inférieure de la base. Utilisez uniquement le cordon téléphonique neuf fourni.
3. Posez les deux câbles dans les deux canaux de câble sur la face arrière de la base.

3.4 Remplacer des batteries

Les batteries rechargeables (AAA, 1,2V, 550mAh) possèdent une autonomie en veille de 100 heures maximum et une durée de communication maximale pouvant atteindre 10 heures. Ouvrez le compartiment des batteries pour mettre en place ou remplacer les batteries et placez les nouvelles batteries dedans en respectant la polarité adéquate, puis refermez le compartiment des batteries. Utilisez uniquement des batteries rechargeables de type AAA 2 x 1,2V.

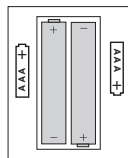

Remarque importante : Laissez le combiné posé sur la base avec l'écran vers l'avant pendant au moins 16 heures. Des batteries incorrectement chargées peuvent provoquer des dysfonctionnements du téléphone. L'icône de capacité de batterie clignote à l'écran au cours de la procédure de charge du combiné. Le voyant de contrôle de la base  sera toujours allumé dès que le combiné est posé.

3.5 Charge des batteries

Les batteries rechargeables de votre téléphone sont dotées à température ambiante d'une autonomie en veille de max. 100 heures et d'une durée de communication maximale de 10 heures. La capacité de batterie actuelle est affichée à l'écran :

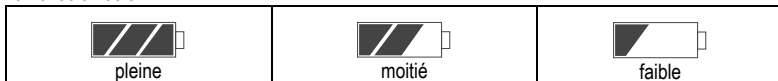

En cas de capacité de batterie insuffisante, l'icône clignote à l'écran et des signaux d'avertissement retentissent toutes les 60 secondes.

Pour charger les batteries, placez le combiné dans la base avec l'écran vers l'avant.











Remarque : Il faut laisser les batteries se charger durant au moins 16 heures avant la première mise en service. Tout comme la batterie de votre voiture, les batteries rechargeables sont inévitablement soumises à un processus de vieillissement. Vous pouvez néanmoins influencer ce processus de vieillissement en leur faisant subir un « entraînement ». Lors d'une utilisation régulière de votre téléphone, si vous chargez cycliquement les batteries et les « videz » à nouveau en téléphonant jusqu'à ce que l'icône  clignote à l'écran, cela sollicite les batteries en augmentant leur capacité et leur durée de vie. En revanche, si les batteries sont chargées ou déchargées en permanence, cela détériore tant leur capacité que leur longévité.

4 Utilisation

4.1 L'écran



En mode de fonctionnement normal, l'écran affiche le nom du combiné. Le nom pré-réglé peut être modifié à tout moment. Voir à cet effet le point 7.7

Toutes les fonctions importantes sont en outre signalées à l'écran par diverses icônes.

	Allumée : vous êtes en communication.
EXT	Allumée : vous êtes en communication externe. Clignote : vous recevez un appel externe.
INT	Allumée : vous êtes en communication interne. Clignote : vous recevez un appel interne.
	Allumée : signale une conférence.
	Allumée : vous vous trouvez dans la liste des appelants (CLIP). Clignote : de nouveaux appels sont enregistrés dans la liste des appelants (CLIP).
	Constant : ces numéros de téléphone de la liste des appelants n'ont pas encore été rappelés.
	Constant : ces numéros de téléphone de la liste des appelants ont déjà été rappelés.
	Allumée : lors de l'utilisation du répertoire.
	Allumée : dès que la programmation est activée.
	Allumée : Le verrouillage du clavier est activé.
	Constant : la liaison avec la base est bonne. Clignote : la portée avec la base est dépassée.
	Constant : le numéro de téléphone comporte plus de 12 chiffres.

4.2 Répondre aux appels

Lorsque vous recevez un appel, la sonnerie retentit sur le combiné et sur la base. La transmission radio fait que le combiné sonne avec un léger retard par rapport à la base. Le message **EXT** clignote à l'écran. Appuyez sur la touche de communication  du combiné et la liaison est établie. L'icône de communication de la base clignote en cours de communication.

Remarque : Vous pouvez modifier le volume de la sonnerie pendant que le combiné sonne à l'aide des touches  et .

Pour mettre fin à la communication, replacez le combiné dans la base ou appuyez sur la touche de communication  du combiné.





Remarques : Pour obtenir des informations sur l'affichage des numéros de téléphone à l'écran, veuillez vous reporter au chapitre 6.

Lorsque la réception automatique des appels est activée, l'appel est automatiquement réceptionné dès que vous décrochez le combiné de la base. Reportez-vous au chapitre 7.5 pour savoir comment activer la réception automatique des appels.

4.3 Appeler

1. Entrez au clavier le numéro de téléphone souhaité comportant au max. 32 chiffres. Les chiffres des touches enfoncées s'affichent à l'écran. L'écran ne pouvant afficher qu'au maximum 12 chiffres, seuls les 12 derniers chiffres sont affichés en cas de numéro de téléphone plus long.





Remarque : Si vous avez entré un chiffre erroné, vous pouvez effacer le numéro de téléphone en appuyant plusieurs fois sur la touche . Vous pouvez effacer entièrement le numéro de téléphone en appuyant longuement sur la touche .

2. Appuyez sur la touche de communication  et la liaison souhaitée est établie.

Remarque : Vous pouvez également appuyer d'abord sur la touche de communication  et obtenir ainsi la tonalité. Votre téléphone compose directement le numéro de téléphone souhaité lorsque vous entrez les chiffres de ce numéro. Cette forme d'établissement de la communication ne permet pas la correction individuelle des chiffres du numéro de téléphone mentionnée ci-dessus.

4.4 Composer les numéros de téléphone enregistrés dans le répertoire



Après avoir enregistré quelques numéros de téléphone, vous pouvez les activer très rapidement et aisément.



1. Appuyez sur la touche de répertoire . L'écran affiche alors dans l'ordre alphabétique le premier numéro de téléphone enregistré.
2. Les touches  et  vous permettent de composer tous les numéros de téléphone enregistrés. Pour composer directement dans l'ordre alphabétique un numéro de téléphone, appuyez sur les lettres correspondantes.
3. Appuyez ensuite sur la touche de communication  et le numéro de téléphone affiché est automatiquement composé.

4.5 Affichage de la durée de communication

La durée de communication est affichée à l'écran en minutes et en secondes en cours de communication. Elle s'affiche à l'écran à la place du numéro composé 15 secondes après la composition du numéro de téléphone. L'indication reste affichée à l'écran pendant quelques secondes après la fin de la communication.

4.6 Activer / désactiver le combiné

Vous pouvez désactiver le combiné en appuyant longuement sur la touche  . Le combiné n'utilise pas l'énergie des batteries lorsqu'il est désactivé. Aucun appel ne peut être réceptionné.

Appuyez une fois sur la touche   pour réactiver le combiné. L'écran affiche le message **BASE** et le combiné est réactivé peu de temps après. Il se réactive automatiquement dès que le combiné est à nouveau posé sur la base.



4.7 Indications concernant la portée

La portée du combiné atteint env. 50 mètres dans des pièces fermées et env. 300 mètres dehors. L'icône  est allumée à l'écran lorsque la liaison avec la base est bonne.



L'icône  clignote à l'écran lorsque vous vous êtes trop éloigné de la base et des signaux d'avertissement retentissent. Rapprochez-vous dans ce cas de la base, car la communication sera autrement interrompue. Vous pouvez désactiver ces signaux sonores d'avertissement comme décrit au chapitre 7.8.

4.8 Désactiver le micro du combiné

La touche  vous permet de désactiver le micro du combiné en cours de communication téléphonique. Vous pouvez ainsi parler sans être entendu de votre correspondant. Le haut-parleur du combiné reste activé, ce qui vous permet de continuer à entendre votre correspondant.





1. Appuyez une fois sur la touche  en cours de communication. L'icône **COUPE** apparaît à l'écran.
2. Pour réactiver le micro, appuyez à nouveau sur la touche . L'icône **COUPE** s'éteint et vous pouvez poursuivre normalement la communication.

4.9 Réglages du volume de l'écouteur

Si vous trouvez que le volume de l'écouteur est trop faible ou trop fort, vous pouvez l'adapter à vos besoins. Vous pouvez régler le volume **en cours de communication** à l'aide des touches  et . Le volume sélectionné est indiqué à l'écran par **VOL ECOUTE 1 à 5**.

4.10 Rappel du dernier numéro composé





Vous pouvez utiliser la fonction de rappel du dernier numéro composé lorsque la ligne de votre correspondant est occupée ou si celui-ci ne répond pas. Votre *téléphone* enregistre les 5 derniers numéros composés.

1. Appuyez sur la touche  et le dernier numéro de téléphone composé s'affiche à l'écran.
2. D'autres numéros de téléphone de la fonction de rappel du dernier numéro composé peuvent ensuite être composés en appuyant plusieurs fois sur la touche . La touche  vous permet de faire défiler en arrière les numéros de la liste.
3. Appuyez ensuite sur la touche de communication  et le numéro de téléphone affiché est automatiquement composé.

Remarque : Lorsqu'un numéro de téléphone de la fonction de rappel du dernier numéro composé est enregistré dans le répertoire, le nom s'affiche automatiquement à l'écran et non pas le numéro de téléphone.



Effacer des numéros de téléphone de la mémoire de rappel du dernier numéro composé

Pour effacer certains numéros de la mémoire de rappel du dernier numéro composé, procédez de la manière suivante :

1. Appuyez sur la touche  et composez à l'aide des touches  et  le numéro de téléphone de la fonction de rappel du dernier numéro composé qui doit être effacé.
2. Appuyez sur la touche  et l'écran affiche **EFFACER ?**.
3. Validez à l'aide de la touche de menu  et le numéro de téléphone est effacé de la mémoire de rappel du dernier numéro composé.

Effacer tous les numéros de téléphone de la mémoire de rappel du dernier numéro composé



Pour effacer tous les numéros de téléphone de la mémoire de rappel du dernier numéro composé, procédez de la manière suivante :

1. Appuyez sur la touche .
2. Maintenez la touche  enfoncée jusqu'à ce que le message **EFF TOUT ?** s'affiche à l'écran.
3. Validez à l'aide de la touche de menu  et le numéro de téléphone est effacé de la mémoire de rappel du dernier numéro composé.

4.11 Verrouillage du clavier

Si vous portez fréquemment le combiné sur vous, vous pouvez verrouiller le clavier afin d'éviter tout enfoncement involontaire des touches. Les appels entrants peuvent être réceptionnés normalement lorsque le verrouillage du clavier est activé.

Activer le verrouillage du clavier.

Appuyez sur la touche  du combiné durant trois secondes. L'icône  s'affiche à l'écran.

Désactiver le verrouillage du clavier

Pour annuler le verrouillage du clavier, appuyez deux fois sur la touche .



Remarque : Le verrouillage du clavier peut également être activé en utilisant le menu.

4.12 Mode tonalités temporaire

Si vous ne pouvez utiliser votre téléphone qu'en mode IMPULSIONS, vous n'êtes pas pour autant obligé de renoncer aux avantages du mode TONALITÉS (par ex. interrogation d'un répondeur). Vous pouvez passer temporairement en mode TONALITÉS en cours de communication à l'aide de la touche .

Votre téléphone se remet automatiquement en mode IMPULSIONS après la fin de la communication.

4.13 Paging de la base vers le combiné

S'il vous est impossible de vous souvenir de l'endroit où se trouve votre combiné, appuyez sur la touche  de la base. Le combiné émet des signaux sonores pendant 30 secondes qui vous permettront ainsi de le retrouver aisément. Vous pouvez mettre fin prématurément aux signaux sonores, en appuyant sur une touche quelconque du combiné ou sur la touche  de la base.

4.14 Autocommutateurs

Si vous avez raccordé votre téléphone à un autocommutateur, vous pouvez bénéficier de toutes les possibilités telles que par ex. le transfert d'appels, le rappel automatique, etc. grâce à la touche de signal « R ». La durée de FLASH « 90ms » (FLASH 1, réglage par défaut) ou « 250ms » (FLASH 2) (réglage, cf. 7.11) est requise pour l'utilisation avec un autocommutateur. Renseignez-vous auprès du vendeur de votre installation pour savoir si votre téléphone fonctionne parfaitement avec votre autocommutateur.

4.15 Utiliser une pause

Des autocommutateurs requièrent la composition d'un certain numéro (p. ex. « 9 » ou « 0 ») pour obtenir la tonalité indiquant l'obtention sur l'appareil de la ligne principale. Pour quelques anciens modèles d'autocommutateurs, il faut attendre un peu avant d'obtenir la tonalité. Il est possible spécialement pour ces autocommutateurs d'introduire une pause automatique après l'obtention de la ligne principale afin que vous puissiez continuer à composer sans attendre la tonalité.

Entrer une pause lors de la composition manuelle de numéros de téléphone









Appuyez une fois sur la touche de rappel du dernier numéro composé  entre le numéro d'accès pour l'obtention de la ligne principale et le numéro de téléphone proprement dit. Après l'obtention de la ligne principale, votre téléphone attend 3 secondes avant de composer le numéro de téléphone proprement dit.

La pause peut également être enregistrée avec les numéros de téléphone du répertoire.

5 Le répertoire



Vous pouvez enregistrer dans le répertoire 30 numéros de téléphone avec les noms. La longueur maximale d'un numéro de téléphone est de 20 chiffres.

5.1 Entrer des numéros de téléphone dans le répertoire

1. Appuyez sur la touche de menu . L'écran affiche le message **REPertoire**.
2. Appuyez de nouveau sur la touche . L'écran affiche le message **Ajouter**.
3. Validez de nouveau à l'aide de la touche de menu . L'écran affiche le message **NOM ?**
4. Entrez alors au clavier le nom correspondant (max. 12 lettres). La section suivante vous indique comment entrer le nom.
5. Validez le nom à l'aide de la touche de menu . L'écran affiche le message **NUMERO ?**.
6. Entrez au clavier le numéro de téléphone souhaité.
7. Validez de nouveau à l'aide de la touche de menu . L'écran affiche le message **Mélodie 1 - 3**.
8. À l'aide des touches de sélection  et , sélectionnez à présent la mélodie que vous souhaitez attribuer à ce numéro de téléphone.
9. Validez de nouveau à l'aide de la touche de menu . L'écran affiche de nouveau le message **Ajouter**.
10. Si vous souhaitez enregistrer d'autres numéros de téléphone, poursuivez avec le point 3. Quittez le mode d'entrée en appuyant sur la touche .

Remarques concernant le répertoire :

- En plus, il est possible d'attribuer à chaque numéro de téléphone l'une des trois mélodies de sonnerie. Vous pouvez ainsi déjà savoir qui vous appelle rien qu'en entendant la mélodie de sonnerie. Cette attribution ne fonctionne que si votre ligne téléphonique et celle de l'appelant disposent de l'affichage des numéros de téléphone CLIP. **En suisse, cette fonction n'est pas proposée par tous les opérateurs de réseau.** Vous trouverez d'autres indications au chapitre 6.
- Pour tous les numéros de téléphone, entrez toujours l'indicatif afin que le téléphone puisse classer aussi des communications locales entrantes dans une inscription de répertoire.
- Lorsque la capacité de mémoire de 30 numéros de téléphone est pleine, l'écran indique le message **MEMOIRE PLEINE** lors de l'enregistrement suivant. Pour disposer à nouveau de place, il faut d'abord effacer d'autres numéros de téléphone.



Conseil ! Vous pouvez également consulter encore le répertoire en cours de communication. Appuyez à cet effet sur la touche  et sélectionnez comme d'habitude une entrée. La touche de menu  affiche le numéro de téléphone enregistré (appuyez deux fois s'il y a plus de 12 chiffres). Vous vous retrouverez à nouveau dans le répertoire en appuyant une nouvelle fois sur la touche de menu .

Explication pour entrer le nom

Les touches de chiffres du clavier comportent des lettres servant à entrer le nom. En appuyant plusieurs fois sur la touche correspondante, vous pouvez entrer des lettres majuscules ainsi que des chiffres.















Exemple : Vous souhaitez entrer le nom « Peter ».

Appuyez sur : 1 x touche 7, 2 x touche 3, 1 x touche 8, 2 x touche 3, 3 x touche 7.











- Appuyez une fois sur la touche  pour entrer un espace.
- En appuyant deux fois sur la touche , vous pouvez en plus entrer un trait d'union.
- Pour entrer deux fois la même lettre, appuyez sur la lettre correspondante et attendez que le curseur se place automatiquement sur la position suivante.
- Vous pouvez effacer les entrées erronées à l'aide de la touche .

- Le répertoire -

5.2 Modifier des numéros de téléphone du répertoire

1. Appuyez sur la touche de menu . L'écran affiche **REPertoire**.
2. Appuyez de nouveau sur la touche . L'écran affiche **Ajouter**.
3. Appuyez à présent sur la touche . L'écran affiche **Modifier**.
4. Validez de nouveau à l'aide de la touche de menu . L'écran affiche alors dans l'ordre alphabétique les numéros de téléphone enregistrés.
5. Sélectionnez à présent à l'aide des touches  et  le numéro de téléphone que vous souhaitez modifier.
6. Validez la sélection à l'aide de la touche de menu . L'écran affiche de nouveau le nom. Le curseur clignote en plus derrière la dernière lettre.
7. Modifiez alors au clavier le nom. Pour savoir comment entrer le nom, reportez-vous au chapitre 5.1.
8. Après avoir procédé aux modifications souhaitées, validez de nouveau à l'aide de la touche de menu . L'écran affiche alors le numéro de téléphone.
9. Modifiez alors au clavier le numéro de téléphone. Chaque chiffre du numéro de téléphone s'efface en appuyant plusieurs fois sur la touche .
10. Après avoir procédé aux modifications souhaitées, validez de nouveau à l'aide de la touche de menu . L'écran affiche le message **Mélodie**.
11. À l'aide des touches de sélection  et , sélectionnez à présent la mélodie que vous souhaitez attribuer à ce numéro de téléphone.
12. Après avoir procédé aux modifications souhaitées, validez de nouveau à l'aide de la touche de menu . L'écran affiche le message **Traiter**.
13. Si vous souhaitez modifier d'autres numéros de téléphone, poursuivez avec le point 4. Quittez le mode de programmation en appuyant sur la touche .

5.3 Effacer des numéros de téléphone du répertoire

1. Appuyez sur la touche de menu . L'écran affiche **REPertoire**.
2. Appuyez de nouveau sur la touche . L'écran affiche **Ajouter**.
3. Appuyez à présent sur la touche . L'écran affiche **Supprimer**.
4. Validez à l'aide de la touche de menu .
5. Sélectionnez à présent à l'aide des touches  et  le numéro de téléphone que vous souhaitez effacer.
6. Lorsque vous avez trouvé le numéro de téléphone souhaité, validez à l'aide de la touche de menu  et l'écran affiche le message **Confirmer?**.
7. Validez de nouveau à l'aide de la touche de menu  et l'inscription de répertoire est effacée. L'écran affiche de nouveau le message **Supprimer**. La procédure d'effacement s'interrompt en appuyant sur la touche .
8. Le message **SUPPRIMER** s'affiche à l'écran lorsque vous avez effacé le numéro de téléphone. Si vous souhaitez effacer d'autres numéros de téléphone, poursuivez avec le point 4. Quittez le mode d'effacement en appuyant sur la touche .

6 Affichage des numéros de téléphone (CLIP)

En suisse, cette fonction n'est pas proposée par tous les opérateurs de réseau.



Attention ! L'affichage des numéros de téléphone est un service proposé en option par votre opérateur de téléphonie. Votre téléphone affiche les numéros de téléphone à l'écran lorsque votre opérateur de téléphonie propose ce service. L'affichage de la date et de l'heure n'est pas transmise par tous les opérateurs de téléphonie. Veuillez vous adresser à votre opérateur de téléphonie pour recevoir de plus amples informations. De même, certains autocommutateurs ne permettent pas la transmission du numéro de téléphone ou de la date et de l'heure.



La présentation du numéro de téléphone vous permet, pour chaque appel entrant, de connaître l'identité de l'appelant. Si votre ligne téléphonique vous permet d'utiliser cette fonction, l'écran vous indique le numéro de téléphone de l'appelant dès que le téléphone sonne.

Si vous avez enregistré ce numéro de téléphone dans votre répertoire, le nom s'affiche à la place du numéro de téléphone. En plus, vous pouvez affecter l'une des trois mélodies de sonnerie à chaque numéro de téléphone enregistré dans le répertoire, ce qui vous permettra de savoir qui vous appelle rien qu'en entendant la mélodie de sonnerie.

Tous les appels sont enregistrés dans une liste des appelants pour que vous ne ratiez aucun appel durant votre absence. 30 numéros de téléphone au total peuvent être enregistrés dans la liste. Le numéro de téléphone le plus ancien est toujours effacé de la liste dès que celle-ci est pleine. Si de nouveaux numéros de téléphone ont été enregistrés dans la liste des appelants durant votre absence, l'écran affiche l'icône .

6.1 La liste des appelants

Procédez de la manière suivante pour visualiser à l'écran les numéros de téléphone de la liste des appelants :

1. Appuyez sur la touche  et le numéro du dernier appel entrant s'affiche à l'écran. Lorsque la liste des appelants est vide, l'écran affiche **VIDE**.
2. Les touches  et  vous permettent de sélectionner d'autres numéros de téléphone de la liste des appelants. En l'absence d'autres numéros de téléphone, un signal sonore retentit. Deux icônes d'écran vous indiquent si l'appel a été réceptionné ou non.





=> L'appel n'a pas été réceptionné.



=> L'appel a été réceptionné.











Remarques : La touche de menu  permet d'appeler des informations.

- Si le numéro de téléphone comporte plus de 12 chiffres, les chiffres restants sont affichés.
 - Affiche le numéro de téléphone lorsque l'appelant est déjà enregistré dans le répertoire avec le nom.
 - Affiche la date et l'heure lorsque ces informations ont été transmises par l'appelant.
 - Lorsqu'aucune autre information n'est disponible, l'écran affiche le message **AJOUTER ?**.
 - La touche  vous permet de retourner à la liste.
3. Si vous souhaitez rappeler directement un numéro de téléphone de la liste des appelants, il vous suffit d'appuyer sur la touche de communication  et le numéro est immédiatement composé.
 4. Quittez la liste des appelants en appuyant sur la touche .

- Affichage des numéros de téléphone (CLIP) -







6.2 Enregistrer dans le répertoire des numéros de téléphone de la liste des appelants

Vous pouvez enregistrer directement dans le répertoire un numéro de téléphone de la liste des appelants.



1. Appuyez sur la touche  et le numéro du dernier appel entrant s'affiche à l'écran.
2. À l'aide des touches  et , sélectionnez à présent les numéros de téléphone de la liste des appelants que vous souhaitez enregistrer dans le répertoire.
3. Appuyez sur la touche  jusqu'à ce que le message **AJOUTER ?** s'affiche à l'écran.
4. Validez de nouveau à l'aide de la touche de menu . L'écran affiche le message **NOM ?**
5. Entrez alors au clavier le nom correspondant (max. 12 lettres).
6. Validez de nouveau à l'aide de la touche de menu  et le numéro de téléphone s'affiche encore une fois à l'écran.
7. Validez de nouveau à l'aide de la touche de menu . L'écran affiche le message **MELODIE 1 – 3**.
8. À l'aide des touches de sélection  et , sélectionnez à présent la mélodie que vous souhaitez attribuer à ce numéro de téléphone.
9. Validez de nouveau à l'aide de la touche de menu  et le numéro de téléphone est enregistré dans le répertoire.

Remarque : Dès que le numéro de téléphone est enregistré dans le répertoire avec un nom, ce nom apparaît dans la liste des appelants à la place du numéro de téléphone.

6.3 Effacer des numéros de téléphone de la liste des appelants

1. Appuyez sur la touche  et le numéro du dernier appel entrant s'affiche à l'écran.
2. À l'aide des touches  et , sélectionnez à présent les numéros de téléphone de la liste des appelants que vous souhaitez effacer.
3. Appuyez sur la touche . L'écran affiche le message **EFFACER ?**.
4. Validez de nouveau à l'aide de la touche de menu  et le numéro de téléphone est effacé de la liste des appelants ou quittez le mode d'effacement en appuyant sur la touche .

6.4 Effacer entièrement la liste des appelants

1. Appuyez sur la touche  et le numéro du dernier appel dans la liste des appelants s'affiche à l'écran.
2. Appuyez sur la touche  jusqu'à ce que le message **EFF TOUT ?** s'affiche à l'écran.
3. Validez de nouveau à l'aide de la touche de menu  pour effacer la liste des appelants ou quittez le mode d'effacement en appuyant sur la touche .



7 Fonctions spéciales

Un menu très convivial pour l'utilisateur permet d'accéder à toutes les autres fonctions de programmation. Voici un petit mode d'emploi général pour vous repérer dans le menu :

La touche  permet de lancer la programmation. L'icône  est allumée à l'écran durant la programmation.

Vous pouvez choisir le niveau souhaité à l'aide des touches  et .

Ce niveau s'ouvre à l'aide de la touche .

Vous pouvez ensuite à nouveau rechercher la fonction souhaitée à l'aide des touches  et , puis valider de nouveau à l'aide de la touche de menu .

La touche  vous permet de revenir au niveau précédent.











Chaque procédure d'enregistrement est automatiquement interrompue en l'absence d'entrée dans un délai de 15 secondes.

En appuyant sur la touche , vous pouvez de nouveau à tout moment quitter la programmation sans effectuer de modifications.

Le chapitre 7.13 vous fournit un aperçu complet du menu.











7.1 Régler les signaux de sonnerie sur le combiné (mélodies de sonnerie)

Votre combiné dispose de trois mélodies de sonnerie différentes pour signaler que vous recevez un appel. Si vous utilisez le système téléphonique avec plusieurs combinés, vous pouvez régler des mélodies distinctes pour les appels externes et les appels internes.

1. Appuyer sur la touche de menu .
2. Sélectionner le menu **COMBINE** à l'aide des touches  et , puis valider à l'aide de la touche .
3. Sélectionner la fonction **MELODIE EXT** (sonnerie pour les appels externes) ou **MELODIE INT** (sonnerie pour les appels interne/seulement si deux combinés) à l'aide des touches  et , puis valider à l'aide de la touche .
4. Sélectionner la mélodie souhaitée à l'aide des touches  et , puis valider à l'aide de la touche .
5. Sélectionnez ensuite d'autres fonctions de menu ou quittez le menu en appuyant sur la touche .

7.2 Volume de la sonnerie du combiné









Le volume de la sonnerie du combiné peut être réglé sur trois niveaux. Vous pouvez également désactiver complètement la sonnerie lorsque vous ne souhaitez pas être dérangé. Lorsque la sonnerie est désactivée, les appels entrants sont seulement signalés sur la base et sur l'écran du combiné.

1. Appuyer sur la touche de menu .
2. Sélectionner le menu **COMBINE** à l'aide des touches  et , puis valider à l'aide de la touche .
3. Sélectionner la fonction **VOL SON INT** (sonnerie pour les appels externes) ou **VOL SON EXT** (sonnerie pour les appels interne/ seulement si deux combinés) à l'aide des touches  et , puis valider à l'aide de la touche .
4. Sélectionner le volume souhaité à l'aide des touches  et  ou désactiver la sonnerie avec **VOLUME COUPE**, puis valider à l'aide de la touche .
5. Sélectionnez ensuite d'autres fonctions de menu ou quittez le menu en appuyant sur la touche .

- Fonctions spéciales -











7.3 Régler les signaux de sonnerie sur la base (mélodie de sonnerie)

La base dispose également de cinq mélodies de sonnerie différentes pour signaler que vous recevez un appel.

1. Appuyer sur la touche de menu .
2. Sélectionner le menu **REGLAGES** à l'aide des touches  et , puis valider à l'aide de la touche .
3. Sélectionner la fonction **MELODIE BASE** à l'aide des touches  et , puis valider à l'aide de la touche .
4. Sélectionner la mélodie souhaitée à l'aide des touches  et , puis valider à l'aide de la touche .
5. Sélectionnez ensuite d'autres fonctions de menu ou quittez le menu en appuyant sur la touche .











7.4 Volume de la sonnerie de la base

Le volume de la sonnerie de la base peut être réglé sur trois niveaux. Vous pouvez également désactiver complètement la sonnerie lorsque vous ne souhaitez pas être dérangé.

1. Appuyer sur la touche de menu .
2. Sélectionner le menu **REGLAGES** à l'aide des touches  et , puis valider à l'aide de la touche .
3. Sélectionner la fonction **VOLUME BASE** à l'aide des touches  et , puis valider à l'aide de la touche .
4. Sélectionner le volume souhaité à l'aide des touches  et  ou désactiver la sonnerie avec **VOLUME COUPE**, puis valider à l'aide de la touche .
5. Sélectionnez ensuite d'autres fonctions de menu ou quittez le menu en appuyant sur la touche .







7.5 Réception automatique des appels

Les appels entrants sont automatiquement réceptionnés lorsque vous décrochez le combiné de la base. Vous pouvez désactiver la réception automatique si vous souhaitez répondre aux appels uniquement en appuyant sur la touche .

1. Appuyer sur la touche de menu .
2. Sélectionner le menu **COMBINE** à l'aide des touches  et , puis valider à l'aide de la touche .
3. Sélectionner la fonction **REPONSE AUTO** à l'aide des touches  et , puis valider à l'aide de la touche .
4. Sélectionner **ACTIVE** ou **DEACTIVE** à l'aide des touches  et , puis valider à l'aide de la touche .
5. Sélectionnez ensuite d'autres fonctions de menu ou quittez le menu en appuyant sur la touche .











7.6 Mode tonalités (MFV) ou impulsions (IWV)

Cette caractéristique vous permet d'utiliser votre téléphone aussi bien avec des installations téléphoniques analogiques (IWV/IMPULSION) qu'avec les nouvelles installations numériques (MFV/ FREQ VOCALE). Le téléphone a été pré-réglé par défaut sur le mode MFV/FREQ VOCALE.

1. Appuyer sur la touche de menu .
2. Sélectionner le menu **REGLAGES** à l'aide des touches  et , puis valider à l'aide de la touche .
3. Sélectionner la fonction **NUMEROTATION** à l'aide des touches  et , puis valider à l'aide de la touche .
4. Sélectionner le mode de sélection souhaité à l'aide des touches  et , puis valider à l'aide de la touche .
5. Sélectionnez ensuite d'autres fonctions de menu ou quittez le menu en appuyant sur la touche .

7.7 Modifier les noms d'écran

En mode normal, le message « D6025 » s'affiche à l'écran. Si vous avez déclaré plusieurs combinés à une base, il peut être utile de donner un nom à chaque combiné. Le numéro indiqué après le nom est celui avec lequel le combiné peut être appelé en interne.

1. Appuyer sur la touche de menu .
2. Sélectionner le menu **COMBINE** à l'aide des touches  et , puis valider à l'aide de la touche .
3. Sélectionner la fonction **NOM** à l'aide des touches  et , puis valider à l'aide de la touche .
4. Entrer au clavier le nom souhaité. Les lettres déjà entrées s'effacent en appuyant plusieurs fois sur la touche .
5. Validez à l'aide de la touche .
6. Sélectionnez ensuite d'autres fonctions de menu ou quittez le menu en appuyant sur la touche .









7.8 Activer/désactiver les signaux sonores d'indication

Divers signaux sonores d'avertissement peuvent être activés ou désactivés.

Clic des touches : Le combiné valide chaque pression de touche par un clic. Vous pouvez activer ou désactiver le clic de touches.











Signal sonore d'avertissement en cas de capacité de batterie trop faible : Lorsque la capacité des batteries est trop faible, un signal d'avertissement retentit pour vous rappeler de charger le combiné.

Avertissement de dépassement de la portée : Si vous vous êtes trop éloigné de la base, un signal sonore d'avertissement vous rappelle que vous allez perdre le contact avec la base.

1. Appuyer sur la touche de menu .
2. Sélectionner le menu **COMBINE** à l'aide des touches  et , puis valider à l'aide de la touche .
3. Sélectionner la fonction **BIP** à l'aide des touches  et , puis valider à l'aide de la touche .
4. Sélectionner à l'aide des touches  et  l'une des fonctions **BIP TOUCHE, BATT FAIBLE** ou **HORS PORTEE** et valider avec .
5. Activer ou désactiver le signal sonore d'avertissement sélectionné à l'aide des touches  et , puis valider à l'aide de la touche .
6. Sélectionnez ensuite d'autres fonctions de menu ou quittez le menu en appuyant sur la touche .

7.9 Modifier le code PIN

Quelques fonctions du système téléphonique sont protégées par un code PIN contre une utilisation non autorisée. Le code PIN se compose de quatre chiffres. Votre téléphone est livré avec le réglage de code PIN « 0000 ». Procédez de la manière suivante pour modifier le code PIN :



1. Appuyer sur la touche de menu .
2. Sélectionner le menu **REGLAGES** à l'aide des touches  et , puis valider à l'aide de la touche .
3. Sélectionner la fonction **CODE PIN** à l'aide des touches  et , puis valider à l'aide de la touche .
4. Entrer à présent au clavier le code PIN actuel de quatre chiffres (réglage par défaut 0 0 0 0) et valider à l'aide de la touche .
5. Entrer ensuite au clavier le nouveau code PIN de quatre chiffres et valider à l'aide de la touche .
6. Entrer encore une fois le nouveau code PIN de quatre chiffres pour le valider et valider à l'aide de la touche .
7. Sélectionnez ensuite d'autres fonctions de menu ou quittez le menu en appuyant sur la touche .

La procédure est interrompue en cas d'entrée erronée de l'ancien code PIN.

- Fonctions spéciales -

7.10 Régler la langue d'affichage à l'écran

Les messages peuvent être affichés à l'écran en allemand, italien, espagne, hollandes, anglais, français et en danois/horvégien/suédois.

1. Appuyer sur la touche de menu .
2. Sélectionner le menu **COMBINE** à l'aide des touches  et , puis valider à l'aide de la touche .
3. Sélectionner la fonction **LANGUE** à l'aide des touches  et , puis valider à l'aide de la touche .
4. Sélectionner une langue à l'aide des touches  et , puis valider à l'aide de la touche .
5. Quittez le mode d'entrée en appuyant sur la touche .

7.11 Régler la durée de FLASH









1. Appuyer sur la touche de menu .
2. Sélectionner le menu **REGLAGES** à l'aide des touches  et , puis valider à l'aide de la touche .
3. Sélectionner la fonction **TOUCHE R** à l'aide des touches  et , puis valider à l'aide de la touche .
4. Sélectionner à l'aide des touches  et  a durée de flash **REGLAGE 1** (90ms) ou **REGLAGE 1** (250ms) et valider à l'aide de .
5. Quittez le mode d'entrée en appuyant sur la touche .

7.12 Rétablir les réglages par défaut

Cette fonction permet de rétablir les réglages par défaut du combiné et de la base. Le répertoire, la liste des appelants (CLIP) ainsi que tous les numéros de téléphone enregistrés dans la fonction de rappel du dernier numéro composé sont effacés.





Réglages par défaut :

Langue : allemand	Nom du combiné : D6025
Signal d'avertissement batterie : activé	Réception automatique des appels : activée
Signal d'avertissement portée : activé	Mélodie de sonnerie externe : 3
Clic de touches : activé	Mélodie de sonnerie interne : 1
Volume de l'écouteur : 3	Volume de sonnerie combiné : 3
Code PIN : 0 0 0 0	Mélodie de sonnerie base : 2
Pause : 3 sec.	Volume de sonnerie base : 3
Mode de sélection : MFV/tonalités	Durée de FLASH : 90ms

1. Appuyer sur la touche de menu .
2. Sélectionner le menu **REGLAGES** à l'aide des touches  et , puis valider à l'aide de la touche .
3. Sélectionner la fonction **REG DEFALT** à l'aide des touches  et , puis valider à l'aide de la touche .
4. Entrer au clavier le code PIN (réglage par défaut 0000) et valider avec la touche . Le message **CONFIRMER ?** s'affiche à l'écran.
5. Valider à l'aide de la touche de menu .
6. Les réglages par défaut sont rétablis au bout d'un bref instant. L'écran se remet en mode attente.

- Fonctions spéciales -

Remarque : Si vous ne vous souvenez plus du code PIN, vous pouvez rétablir les réglages par défaut même sans code PIN.

1. Retirez une batterie du combiné.
2. Maintenez la touche  enfoncée et remettez la batterie en place. Appuyez sur la touche  jusqu'à ce que le message **REG DEFALT** s'affiche à l'écran.
3. Validez à l'aide de la touche  et les réglages par défaut sont rétablis. Vous pouvez interrompre la procédure à l'aide de la touche .

7.13 Structure du menu

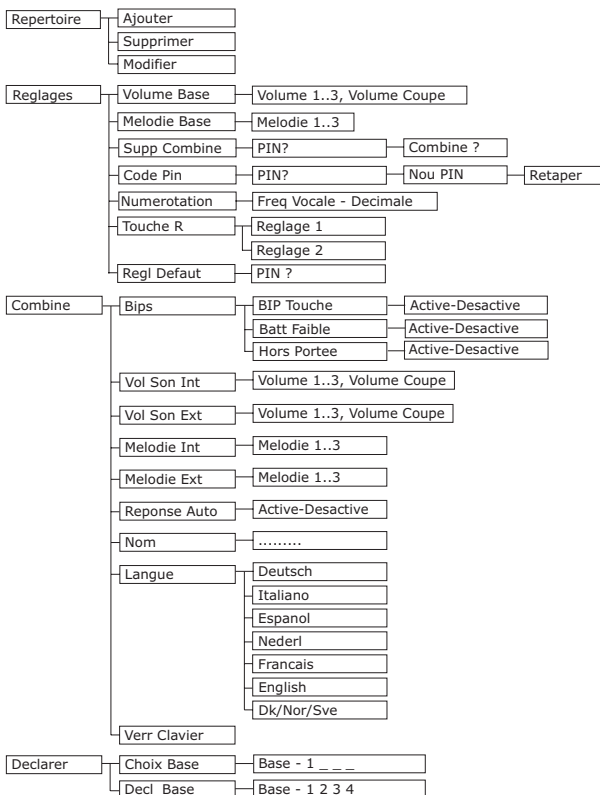

8 Plusieurs combinés

Vous pouvez déclarer jusqu'à un combiné supplémentaire à votre base.

Remarque : Le standard GAP normalisé à l'échelle internationale permet également d'intégrer dans le système téléphonique des combinés fabricants. Vous pouvez de même raccorder un combiné SWITEL à des bases d'autres fabricants dans la mesure où ces appareils fonctionnent avec le standard GAP.



L'utilisation de plusieurs combinés vous octroie les possibilités suivantes :

- Communications internes entre les combinés
- Possibilité de transfert d'appels externes entre les combinés.
- Les appels externes entrants sont signalisés sur tous les combinés.

Remarque : Si la ligne externe est déjà occupée par un autre combiné, le voyant de contrôle est allumé sur l'écouteur de tous les autres combinés. Dans ce cas, il n'est pas possible d'effectuer un autre appel externe.

8.1 Communications internes

Vous pouvez effectuer des communications internes dès que vous avez raccordé plusieurs combinés à une base.

Appuyez à cet effet sur la touche , puis sur le numéro du combiné souhaité. La touche de communication  permet de répondre à l'appel sur le combiné appelé.

8.2 Transférer les appels externes sur un autre combiné











Si vous avez répondu à un appel externe sur un combiné, vous avez la possibilité de le transférer sur un autre combiné. Appuyez à cet effet sur la touche , puis sur le numéro du combiné souhaité. Après réception de l'appel interne sur l'autre combiné, vous disposez des possibilités suivantes :

A. Consultation / Va-et-vient : Vous pouvez alors parler avec l'interlocuteur interne et rétablir la communication avec votre correspondant externe en appuyant sur la touche . Vous pouvez ainsi passer autant que vous le souhaitez de la communication interne à la communication externe et inversement.

B. Transfert d'appel : L'appel externe se transfère sur le combiné appelé en appuyant sur la touche de communication  du premier combiné.

8.3 Déclaration et annulation de la déclaration de combinés

8.3.1 Déclaration de combinés

1. Maintenez la touche page  de la base enfoncée pendant 6 secondes jusqu'au retentissement de deux signaux sonores. Vous disposez alors de 90 secondes pour déclarer le nouveau combiné à la base.
2. Appuyez sur la touche  du combiné.
3. Sélectionnez le menu **DECLARER** à l'aide des touches  et  puis validez à l'aide de la touche .
4. Sélectionner le menu **DECL_BASE** à l'aide des touches  et , puis validez à l'aide de la touche .
5. Entrez alors au clavier le numéro de la base (1 - 4). Si le combiné est déjà relié à une base, les numéros correspondants clignotent.
6. Validez votre entrée à l'aide de la touche .
7. Entrez ensuite le code PIN de la base (réglage par défaut 0 0 0 0).
8. Validez votre entrée à l'aide de la touche  ; vous entendez au bout de quelques secondes un signal sonore. Le combiné est à présent déclaré et peut être utilisé pour des communications internes et externes.
9. Un numéro de téléphone interne a été automatiquement attribué au combiné. Le combiné principal déjà déclaré a le numéro interne 1. Le deuxième combiné déclaré reçoit le numéro d'appel interne 2. Ce numéro interne est affiché à l'écran à droite à côté du nom.











- Plusieurs combinés -

8.3.2 Déclaration d'autres téléphones DECT-GAP à la base

Pour déclarer un combiné DECT-GAP, suivez les instructions du mode d'emploi de l'autre fabricant et appuyez ensuite sur la touche  sur la base durant 6 secondes. Utilisez pour la déclaration le code PIN 0 0 0 0.

8.3.3 Annuler la déclaration de combinés

L'annulation de la déclaration d'un combiné ne peut se faire qu'au moyen d'un autre combiné qui est encore déclaré. Il n'est donc pas possible de procéder à cette annulation de la déclaration en utilisant le combiné dont la déclaration doit être annulée.











1. Appuyez sur la touche  du combiné.
2. Sélectionner le menu **REGLAGES** à l'aide des touches  et  puis valider à l'aide de la touche .
3. Sélectionner la fonction **SUPP COMBINE** à l'aide des touches  et , puis valider à l'aide de la touche .
4. Entrer ensuite le code PIN de la base (réglage par défaut 0 0 0 0) et valider à l'aide de la touche .
5. Sélectionnez à présent le numéro du combiné dont la déclaration doit être annulée 1 ou 2 et validez à l'aide de la touche . Vous pouvez interrompre la procédure à l'aide de la touche . Un signal sonore retentit au bout de quelques secondes lorsque l'annulation de la déclaration s'est effectuée avec succès. Le combiné n'est plus déclaré et ne peut plus être utilisé pour des communications internes et externes.

8.4 Bases supplémentaires

Vous pouvez augmenter la portée des combinés en utilisant plusieurs bases. Pour bénéficier de cet effet, toutes les bases doivent être reliées à un raccordement téléphonique. Selon l'application, vous pouvez affecter le même numéro de téléphone à toutes les bases ou leur attribuer des numéros de téléphone distincts. Veillez à ce que les portées de toutes les bases se chevauchent. Veuillez tester la portée des combinés avant chaque mise en service d'une nouvelle base.

Lorsque vous avez déclaré un combiné aux bases et que la sélection automatique de la base est activée (ce chapitre contient de plus amples informations à ce sujet), le combiné est toujours dirigé automatiquement vers la base la plus proche. **Les communications en cours ne peuvent pas** être transférées d'une base sur une autre.

Sélection d'une base

1. Appuyez sur la touche  du combiné.
2. Sélectionnez le menu **DECLARER** à l'aide des touches  et  puis validez à l'aide de la touche .
3. Sélectionner le menu **SELECT BASE** à l'aide des touches  et , puis valider à l'aide de la touche .
4. L'écran affiche à présent toutes les bases auxquelles le combiné a déjà été déclaré. Le numéro de la base actuellement active clignote. Sélectionnez au clavier la nouvelle base à laquelle vous souhaitez que le combiné soit relié.
Ou passez à l'aide des touches  et  au réglage **AUTO**. Avec ce réglage, le combiné passe automatiquement à la base la plus proche lorsque la liaison avec la base actuelle est trop faible.
5. Validez à l'aide de la touche .

- Suppression des erreurs - Caractéristiques techniques -

9 Suppression des erreurs

Si vous avez des problèmes avec votre téléphone, veuillez suivre les indications ci-après. Veuillez vous adresser à votre revendeur en cas de droits à la garantie. La garantie dure 2 ans. Les batteries rechargeables bénéficient d'une garantie de 12 mois.

Aucune communication possible	La ligne téléphonique n'est pas correctement raccordée ou est en dérangement. Utilisez uniquement le cordon téléphonique fourni. Testez à l'aide d'un autre téléphone le fonctionnement de votre raccordement téléphonique. Le bloc d'alimentation n'est pas branché ou il y a une panne de secteur. Les batteries rechargeables sont vides ou défectueuses. Vous vous êtes trop éloigné de la base.
Liaison entrecoupée ou interrompue	Vous vous êtes trop éloigné de la base. Lieu d'installation de la base incorrect.
Composition de numéros de téléphone impossible	Mode de sélection mal réglé (chapitre 7.6).
Le système ne réagit plus ou se trouve dans un état indéfini.	Rétablissez les réglables par défaut de toutes les fonctions. Retirez brièvement au préalable le bloc d'alimentation de la prise de courant. Réglage par défaut voir chapitre 7.12
Le voyant de contrôle de charge ne s'allume pas	Posez correctement le combiné sur la base, nettoyez les surfaces de contact du combiné et celles de la base à l'aide d'un chiffon sec et doux.
L'icône de batterie clignote à l'écran au bout de quelques heures	Laissez le combiné posé sur la base pendant 10 heures. Si cela n'a rien changé, remplacez les batteries rechargeables.
Affichage d'écran sombre	Provoqué par le rayonnement soleil direct, laissez l'appareil se refroidir.

10 Caractéristiques techniques

Standard	DECT
Nombre de canaux	1880 à 1990 MHz
Alimentation électrique	Base 220/230V, 50 Hz
Portée	à l'intérieur jusqu'à 50m
Portée	dehors jusqu'à 300m
Autonomie en veille	jusqu'à 100 heures
Durée max. de communication	jusqu'à 10heures
Batteries rechargeables	2 x 1,2V/550mA, type AAA
Mode de sélection	MFV ou IWV
Température ambiante admissible	10°C à 30°C
Humidité relative admissible	20 à 75%
Fonction de touche signal	90ms, 250ms

- Informazioni generali -

1	Informazioni generali	44	7	Funzioni speciali.....	55
2	Elementi di comando	45	7.1	Regolazione dei segnali di chiamata nell'unità portatile (melodie della suoneria).....	55
3	Messa in funzione.....	46	7.2	Volume del segnale di chiamata dell'unità portatile	55
3.1	Informazioni di sicurezza	46	7.3	Regolazione dei segnali di chiamata nella stazione base (melodie della suoneria)	56
3.2	Controllo del contenuto della confezione.....	46	7.4	Volume del segnale di chiamata della stazione base	56
3.3	Collegamento della stazione base.....	46	7.5	Ricezione automatica delle chiamate	56
3.4	Le batterie scambiano.....	46	7.6	Modalità di selezione a FREQUENZE oppure ad IMPULSI.....	56
3.5	Carica delle batterie	46	7.7	Modifica dei nomi nel display	57
4	Impiego.....	47	7.8	Attivazione / disattivazione dei segnali acustici d'avvertimento	57
4.1	Il display	47	7.9	Modifica del codice PIN.....	57
4.2	Ricezione delle telefonate.....	47	7.10	Selezione della lingua nel display	58
4.3	Conversazioni telefoniche.....	48	7.11	Regolazione del periodo FLASH.....	58
4.4	Selezione del numero di telefono memorizzato dalla rubrica telefonica	48	7.12	Ripristino alle impostazioni di fabbrica.....	58
4.5	Indicazione della durata di conversazione.....	48	7.13	Struttura del menu	59
4.6	Inserimento/disinserimento dell'unità portatile.....	48	8	Parecchie unità portatili	60
4.7	Informazioni riguardanti il raggio d'azione	48	8.1	Telefonate interne	60
4.8	Ammutolazione del microfono nell'unità portatile.....	49	8.2	Deviazione delle telefonate esterne ad un'altra unità portatile	60
4.9	Regolazione del volume della cornetta.....	49	8.3	Registrazione e deregistrazione di unità portatili	60
4.10	Ripetizione della chiamata	49	8.3.1	Registrazione di unità portatili.....	60
4.11	Blocco della tastiera.....	50	8.3.2	Registrazione di altri telefoni DECT-GAP alla stazione base.....	61
4.12	Selezione temporanea a frequenze.....	50	8.3.3	Deregistrazione di unità portatili	61
4.13	Paging dalla stazione base all'unità portatile... ..	50	8.4	Stazioni base supplementari	61
4.14	Impianti interni di centralino	50	9	Rimedio in caso di errori.....	62
4.15	Utilizzo della pausa	50	10	Dati tecnici.....	62
5	La rubrica telefonica	51			
5.1	Immissione di numeri nella rubrica telefonica.. ..	51			
5.2	Modifica dei numeri memorizzati nella rubrica telefonica	52			
5.3	Cancellazione del numero di telefono dalla rubrica telefonica	52			
6	Indicazione del numero degli interlocutori (CLIP)	53			
6.1	La lista delle chiamate	53			
6.2	Memorizzazione dei numeri telefonici dalla lista delle chiamate nella rubrica telefonica	54			
6.3	Cancellazione di singoli numeri telefonici dalla lista delle chiamate	54			
6.4	Cancellazione dell'intera lista delle chiamate	54			

1 Informazioni generali

Batterie ricaricabili - Non utilizzare altre batterie ricaricabili o accumulatori universali. Questi potrebbero causare eventualmente un cortocircuito. Sostituire le batterie esclusivamente con batterie **ricaricabili** del tipo AAA 1,2 Volt, 550mA. Non gettare le batterie nel fuoco o immergerle nell'acqua. Le batterie vecchie o difettose non devono essere smaltite nei normali rifiuti domestici. Se l'unità portatile si riscalda durante il procedimento di ricarica, ciò è del tutto normale e non costituisce alcun pericolo. Non ricaricare l'unità portatile con un caricabatteria estraneo, poiché, altrimenti, non sarebbero da escludere danneggiamenti.

Luogo d'installazione - Nel luogo d'installazione deve essere disponibile una presa di corrente da 230Volt. Non disporre la stazione base nelle immediate vicinanze di altri apparecchi elettronici, quali ad esempio forni a microonde o impianti stereofonici, poiché in questa circostanza non sarebbero da escludere delle interferenze reciproche. Il luogo d'installazione ha un influsso determinante per un funzionamento perfetto ed irreprensibile del telefono. Disporre la stazione base su una superficie piana e antiscivolo. Normalmente i piedini di gomma della stazione base non lasciano tracce sulla superficie d'appoggio. Tuttavia, a causa degli innumerevoli tipi di smalto utilizzati sulle superfici, non è possibile escludere sempre che sulla superficie d'appoggio rimangano tracce dei piedini di gomma dell'apparecchio. Non utilizzare l'unità portatile in zone a rischio di esplosione. Evitare di esporre l'apparecchio ad eccessive sollecitazioni, quali ad esempio fumo, polvere, urti, sostanze chimiche, umidità, calore o diretta esposizione ai raggi solari.

Informazione medica - L'apparecchio telefono lavora con una potenza di trasmissione molto bassa. Conformemente allo stato attuale delle ricerche scientifiche e della tecnica, con questa ridotta potenza di trasmissione sono da escludere comunque dei danni alla salute. Tuttavia, è stato dimostrato, che i telefoni portatili in stato inserito possono causare interferenze in prossimità di apparecchiature elettromedicali. Pertanto, mantenere una distanza di almeno un metro da apparecchiature elettromedicali.

Smaltimento - Quando le batterie ricaricabili ovvero quando l'intero impianto si saranno completamente esauriti, sarà necessario provvedere ad uno smaltimento appropriato e conforme alle prescrizioni vigenti per la protezione ambientale.

Temperatura e condizioni ambientali - Il telefono è concepito per funzionare in ambienti protetti in un campo di temperatura da 10 °C a 30 °C. La stazione base non deve essere installata in ambienti umidi, come ad esempio in bagno o nella lavanderia. Evitare possibilmente fonti di calore, quali termosifoni, e non esporre l'apparecchio direttamente ai raggi solari.

Pulizia e manutenzione

Le superfici del contenitore possono essere pulite con un panno asciutto, morbido e non filamentoso. Non utilizzare mai detersivi o addirittura solventi aggressivi. Oltre ad una pulizia occasionale del contenitore dell'apparecchio non è necessaria alcuna particolare manutenzione. I piedini di gomma della stazione base non sono, comunque, resistenti contro tutti i tipi di detersivi. Pertanto, il produttore non potrà assumersi alcuna responsabilità per eventuali danni causati ai mobili o simili.

2 Elementi di comando

Unità portatile

- 1 Spia di conversazione
- 2 Ripetizione della chiamata
- 3 Tasto menu
- 4 Tasto di conversazione
- 5 Tasti di selezione/
La lista delle chiamate (CLIP)
- 6 Conversazioni interne
- 7 Tasto di segnale R
- 8 Rubrica telefonica
- 9 Tasto d'ammutolazione/cancellazione

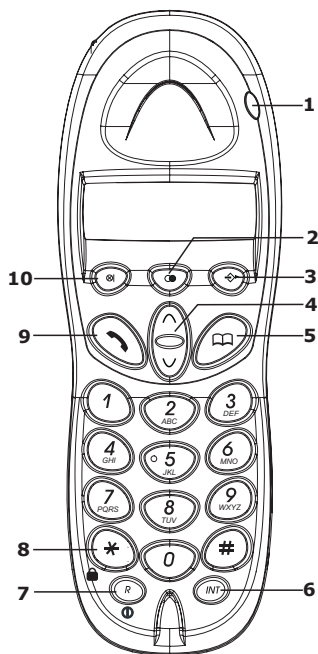

Stazione base

- 1 Tasto PAGE
- 2 Spia di controllo della carica
- 3 Spia di conversazione e rete

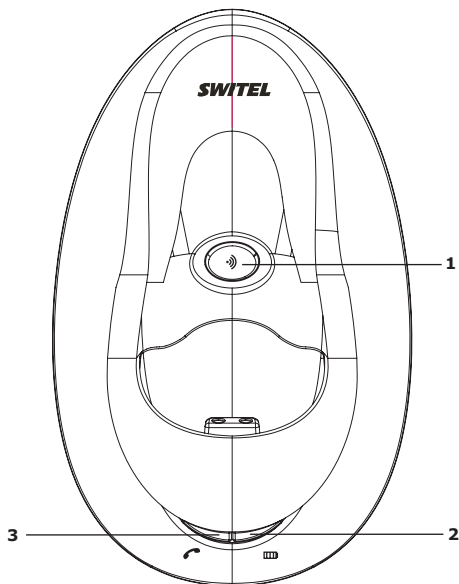

- Messa in funzione -

3 Messa in funzione

3.1 Informazioni di sicurezza

ATTENZIONE! Prima della messa in funzione è assolutamente necessario leggere le informazioni di sicurezza generali riportate all'inizio di queste istruzioni per l'uso.

3.2 Controllo del contenuto della confezione

La dotazione comprende:

una stazione base	un cavo d'alimentazione
un'unità portatile con le batterie	clip per cintura
un cavo telefonico di collegamento	istruzioni per l'uso

3.3 Collegamento della stazione base

Disporre l'apparecchio telefono in prossimità di una presa telefonica e di una presa di corrente.

- Inserire la spina dell'alimentatore di rete nella boccola situata nella parte inferiore della stazione base e l'alimentatore di rete in una presa di corrente da 230V installata conformemente alle prescrizioni vigenti sul luogo. L'alimentatore di rete della stazione base deve essere sempre collegato alla presa di corrente. Per motivi di sicurezza è necessario utilizzare esclusivamente l'alimentatore di rete fornito.
- Collegare il presente cavo telefonico con la presa della linea telefonica e la boccola telefonica situata nella parte inferiore della stazione base. Utilizzare esclusivamente il nuovo cavo telefonico fornito in dotazione.
- Applicare i due cavi attraverso le due canaline e farli uscire dalla parte posteriore della stazione base.

3.4 Le batterie scambiano

Le batterie ricaricabili (AAA, 1,2V, 550mAh) possiedono una capacità in standby di massimo 100 ore e una capacità di conversazione massima di 10 ore. Aprite il coperchio dell'alloggiamento delle batterie per introdurle oppure sostituirle. Introdurre a questo punto le batterie, rispettando la corretta polarità, e chiudere di nuovo il coperchio dell'alloggiamento. Utilizzare esclusivamente batterie ricaricabili del tipo AAA 2 x 1,2V.

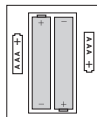

Informazione importante: Appoggiare l'unità portatile sopra la stazione base con il display rivolto in avanti per la durata di almeno 16 ore. Nel caso di una carica non corretta delle batterie, non sono da escludere delle disfunzioni nel telefono. Durante il processo di carica dell'unità portatile, nel display lampeggia il simbolo d'indicazione della capacità delle batterie. La spia di controllo della stazione base  si illumina sempre, non appena vi appoggiate sopra l'unità portatile.

3.5 Carica delle batterie

Le batterie ricaricabili dell'apparecchio telefono sono previste per funzionare con un periodo standby a temperatura ambiente di max. 100 ore ed una durata di conversazione massima di 10 ore. La capacità attuale delle batterie viene indicata nel display.



Se la capacità delle batterie è troppo bassa, lampeggia il rispettivo simbolo nel display e ogni 60 secondi si sentono dei rispettivi segnali acustici d'avvertimento.











Per ricaricare le batterie basta immettere l'unità portatile nella stazione base con il display rivolto in avanti.

Avvertenza: Prima della prima messa in funzione è necessario caricare le batterie per una durata di almeno 16 ore. Le batterie ricaricabili sono soggette ad un inevitabile invecchiamento, come ad esempio anche le batterie di automobili. Tuttavia, è possibile influenzare questo processo d'invecchiamento, "allenando" in un certo qual modo le batterie. Se in un regolare impiego del Vostro telefono ricaricate periodicamente le batterie, per poi riscicarle a "suoni di telefonate", fino a quando non incomincia a lampeggiare l'indicazione  nel display, stimolate praticamente le batterie, che Vi ricompenseranno così con un rendimento completo ed efficace nonché una lunga durata di funzionamento. Contrariamente a ciò, una carica continua ed uno scaricamento altrettanto continuo, danneggiano notevolmente le batterie, pregiudicandone, inoltre, la capacità e la durata di funzionamento.

4 Impiego

4.1 Il display

In condizioni di funzionamento normali, nel display viene visualizzato il nome dell'unità portatile. Il nome preimpostato può comunque essere cambiato in qualsiasi momento. Si veda a tal fine al capitolo 7.7. Inoltre, nel display vengono visualizzate tutte le informazioni più importanti con diversi simboli.

	Illuminato: conversazione attualmente in corso.
EXT	Illuminato: conversazione esterna attualmente in corso. Lampeggiante: chiamata esterna in arrivo.
INT	Illuminato: conversazione interna attualmente in corso. Lampeggiante: chiamata interna in arrivo.
	Illuminato: conversazione in conferenza attualmente in corso.
	Illuminato: Vi trovate nella lista delle chiamate (CLIP). Lampeggiante: nella lista delle chiamate (CLIP) sono memorizzate delle nuove telefonate.
	Costante: questo numero telefonico della lista degli interlocutori non è stato ancora richiamato.
	Costante: questo numero telefonico della lista degli interlocutori è già stato richiamato.
	Lampeggiante: esaurimento della capacità delle batterie. Prego ricaricare l'unità portatile. Illuminato: indicazione della capacità delle batterie
	Illuminato: durante l'impiego della rubrica telefonica.
	Illuminato: non appena viene attivato il livello di programmazione.
	Illuminato: Blocco della tastiera attivato.
	Costante: il collegamento alla stazione è buono. Lampeggiante: il raggio d'azione dalla stazione base è stato superato.
	Costante: il numero telefonico è più lungo di dodici posizioni.

4.2 Ricezione delle telefonate

In una chiamata in arrivo si sente il segnale acustico (squillo) nell'unità portatile e nella stazione base. A causa della radiotrasmissione, l'unità portatile squilla sempre con un certo ritardo rispetto alla stazione base. Nel display lampeggia l'indicazione **EXT**. Premere il tasto di conversazione  nell'unità portatile, per stabilire così il collegamento. Durante la conversazione lampeggia la rispettiva indicazione nella stazione base.

Avvertenza: Mentre squilla l'unità portatile, tramite i tasti  e  potete anche regolare il volume del segnale di chiamata.

Per terminare la conversazione, immettere come di consueto l'unità portatile nella stazione base oppure premere il tasto di conversazione  nella stazione base.





Note: Le informazioni per la visualizzazione del numero telefonico sul display sono da apprendere al capitolo 6.

Nell'attivazione della funzione di ricezione automatica delle chiamate, la telefonata viene automaticamente ricevuta, non appena sollevate l'unità portatile dalla stazione base. La modalità d'attivazione della funzione di ricezione automatica delle chiamate è da apprendere al capitolo 7.5.

4.3 Conversazioni telefoniche

1. Digitare il numero di telefono desiderato nella tastiera numerica con massimo 32 posizioni. Le cifre digitate vengono visualizzate nel display. Poiché il display può visualizzare al massimo 12 posizioni, nei numeri telefonici più lunghi verranno indicate soltanto le ultime 12 cifre.





Avvertenza: Se avete accidentalmente digitato un numero telefonico non corretto, allora potete cancellare il numero sbagliato, premendo ripetutamente il tasto . Mantenendo premuto più a lungo il tasto , il numero telefonico viene completamente cancellato.

2. Premere il tasto di conversazione  ed il collegamento desiderato viene subito stabilito.

Avvertenza: Potete anche premere prima il tasto di conversazione , per ottenere in tal modo un immediato segnale di linea libera. Digitando le cifre corrispondenti al Vostro numero telefonico desiderato, il telefono può comporre direttamente il numero da chiamare. In questa modalità di stabilire un collegamento non è, tuttavia, possibile eseguire una correzione delle singole cifre del numero telefonico, come descritto sopra.

4.4 Selezione del numero di telefono memorizzato dalla rubrica telefonica



Dopo che avete memorizzato alcuni numeri telefonici, potete richiamarli molto rapidamente con facilità.



1. Premere il tasto della rubrica telefonica . A questo punto nel display viene visualizzato in ordine alfabetico il primo numero telefonico memorizzato.
2. Tramite i tasti  e  potete ora chiamare tutti i numeri telefonici memorizzati. Per chiamare direttamente in ordine alfabetico un numero telefonico, premere la rispettiva lettera.
3. Premere a questo punto il tasto di conversazione  ed il numero telefonico visualizzato viene ora chiamato automaticamente.

4.5 Indicazione della durata di conversazione

Durante una conversazione la durata rispettiva viene visualizzata nel display in minuti e secondi. 15 secondi dopo la selezione, il display commuta direttamente dalla visualizzazione del numero telefonico composto all'indicazione della durata della conversazione. Al termine della conversazione l'indicazione rimane ancora visualizzata nel display per la durata di alcuni secondi.

4.6 Inserimento/disinserimento dell'unità portatile

L'unità portatile può essere disinserita semplicemente, mantenendo premuto più a lungo il tasto  . Dopo il disinserimento dell'unità portatile, ovviamente non viene più consumata la corrente delle batterie. In questo stato non si possono, però, ricevere alcune telefonate.

Premere una volta il tasto  , per reinserire di nuovo l'unità portatile. Nel display viene ora visualizzato il messaggio **BASE** e l'unità portatile viene reinserita nuovamente dopo breve tempo. L'unità portatile si inserisce automaticamente non appena la riappoggiate sulla stazione base.

4.7 Informazioni riguardanti il raggio d'azione



Il raggio d'azione dell'unità portatile corrisponde a ca. 50 metri in ambienti chiusi e a ca. 300 metri all'aperto. In una

buona trasmissione con la stazione base, nel display si illumina il simbolo . Quando Vi allontanate

eccessivamente dalla stazione base, allora nel display incomincia a lampeggiare il simbolo  e sentite dei rispettivi segnali acustici d'avvertimento. In questo caso è necessario riavvicinarsi alla stazione base, poiché, altrimenti, verrebbe subito interrotta la conversazione. Questi segnali acustici d'avvertimento possono anche essere disattivati, come descritto al capitolo 7.8.



4.8 Ammutolazione del microfono nell'unità portatile

Tramite il tasto  potete disinserire il microfono dell'unità portatile durante una conversazione telefonica. In tal modo è possibile parlare con altre persone, senza essere ascoltati dall'utente in linea. L'altoparlante dell'unità portatile rimane, tuttavia, inserito, in modo da poter ascoltare ulteriormente l'utente in linea.

1. Premere il tasto  durante una conversazione. Dopodiché nel display viene visualizzata l'indicazione **SILENZIARE**.
2. Per inserire di nuovo il microfono, basta premere nuovamente il tasto . L'indicazione **SILENZIARE** visualizzata nel display scompare e dopodiché potete proseguire normalmente la conversazione.

4.9 Regolazione del volume della cornetta





Se il volume della cornetta Vi dovesse sembrare troppo basso o troppo alto, potete anche adattarlo individualmente alle Vostre esigenze.

Tramite i tasti  e  potete adattare come volete il volume della cornetta **durante una conversazione**. Nel display il volume della cornetta regolato viene visualizzato con **VOLUME 1 fino 5**.

4.10

Ripetizione della chiamata





La funzione di ripetizione della chiamata può essere utilizzata nei casi in cui la persona chiamata non risponde al telefono. Il Vostro *telefono* memorizza sempre gli ultimi cinque numeri telefonici composti.

1. Premendo a questo punto il tasto , l'ultimo numero telefonico composto viene visualizzato nel display.
2. Premendo il tasto , potete ora selezionare ulteriori numeri telefonici presenti nella memoria della funzione di ripetizione della chiamata. Tramite il tasto  potete sfogliare la lista in avanti oppure indietro.
3. Premere a questo punto il tasto di conversazione  ed il numero telefonico visualizzato viene ora chiamato automaticamente.

Nota: Se nella memoria della funzione di ripetizione della chiamata vi è memorizzato un numero di telefono della rubrica telefonica, nel display verrà automaticamente visualizzato il rispettivo nome e non il numero telefonico.



Eliminazione di singoli numeri telefonici dalla lista di ripetizione delle chiamate

Per cancellare singoli numeri telefonici dalla lista di ripetizione delle chiamate, occorre procedere nel modo seguente:

1. Premere il tasto  e selezionare quindi attraverso i tasti  e  il numero telefonico della lista di ripetizione delle chiamate che deve essere cancellato.
2. Premere il tasto . Nel display viene visualizzato **CANCELLA?**.
3. Confermare con il tasto menu , per cancellare quindi il numero telefonico dalla lista di ripetizione delle chiamate.

Eliminazione di tutti i numeri telefonici dalla lista di ripetizione delle chiamate

Per cancellare tutti i numeri telefonici dalla lista di ripetizione delle chiamate, occorre procedere nel modo seguente:

1. Premere il tasto .
2. Mantenere premuto il tasto , finché sul display non viene visualizzato il messaggio **CANC TUTTO?**.
3. Confermare con il tasto menu , per cancellare quindi il numero telefonico dalla lista di ripetizione delle chiamate.

4.11 Blocco della tastiera

Se portate spesso appresso l'unità portatile, avete anche la possibilità di interdire la tastiera, al fine di evitare che i tasti vengano premuti involontariamente. Nella funzione di blocco della tastiera inserita, le chiamate dall'esterno possono essere ricevute come di consueto.

Attivazione del blocco tastiera

Mantenere premuto nell'unità portatile per 3 secondi il tasto . Nel display viene visualizzato il simbolo .

Disattivazione del blocco tastiera



Per annullare nuovamente il blocco della tastiera, basta premere nuovamente due volte il tasto .

Nota: Il blocco della tastiera può anche essere attivato attraverso il menu.

4.12 Selezione temporanea a frequenze
Se il Vostro telefono funziona solamente con la modalità di selezione ad IMPULSI, non dovete comunque rinunciare alle comode funzioni della modalità di selezione a FREQUENZE (ad esempio: interrogazione di una segreteria telefonica). Durante una conversazione, mediante il tasto  potete commutare momentaneamente alla modalità di selezione a FREQUENZE.

Al termine della conversazione viene nuovamente attivata la modalità di selezione ad IMPULSI.

4.13 Paging dalla stazione base all'unità portatile

Se qualche volta Vi siete dimenticati, dove avete lasciato per ultimo l'unità portatile, basta semplicemente premere il tasto  della stazione base. A questo punto, per la durata di 30 secondi, si sentono dei segnali acustici, provenienti dall'unità portatile, che Vi permettono facilmente di ritrovare l'apparecchio. Mediante un qualsiasi tasto a piacere nell'unità portatile oppure tramite il tasto  della stazione base si possono disattivare anticipatamente i segnali acustici di localizzazione.

4.14 Impianti interni di centralino

Se avete collegato il Vostro telefono ad un impianto interno di centralino, potete sfruttare tutte le più moderne possibilità oggi offerte dai gestori delle reti telefoniche, come ad esempio la deviazione delle telefonate, il richiamo automatico, ecc. Il tasto di segnale "R" Vi permette di accedere a tutte queste comodissime possibilità e funzioni. Generalmente in un impianto interno di centralino viene utilizzato un periodo FLASH di "90ms" (FLASH 1, impostazione di fabbrica) oppure „250ms" (FLASH 2). Per l'impostazione si veda al capitolo 7.11. Potete comunque domandare al Vostro rivenditore di fiducia specializzato, che Vi ha venduto l'impianto interno di centralino, se il Vostro telefono funziona perfettamente ed in modo irreprensibile e quali ulteriori possibilità poter sfruttare con questo sistema.

4.15 Utilizzo della pausa

In alcuni impianti interni di centralino è necessario comporre prima un determinato numero (ad esempio "9" oppure "0"), per ottenere quindi un segnale d'accesso alla rete esterna nel telefono dopo una breve pausa. Alcuni impianti di centralino più vecchi possono impiegare un certo periodo prima di ottenere un segnale di linea libera. Specialmente per questi impianti interni di centralino dopo il numero d'accesso alla rete esterna si può introdurre una pausa automatica, per permettere una diretta composizione del numero telefonico, senza dover attendere il segnale di linea libera.

Immissione della pausa nella selezione manuale









Premere una volta il tasto di ripetizione della chiamata  tra il numero di riferimento per l'accesso alla rete esterna ed il numero telefonico reale. Dopo l'accesso alla rete esterna il Vostro telefono attende 3 secondi prima della composizione del numero telefonico reale.

La pausa può essere memorizzata anche nella rubrica telefonica insieme ai numeri telefonici.

5 La rubrica telefonica

Nella rubrica telefonica si possono memorizzare fino a 30 numeri telefonici con l'assegnazione del rispettivo nome dell'utente. La massima lunghezza di un numero telefonico corrisponde a 20 posizioni.



5.1 Immissione di numeri nella rubrica telefonica

1. Premere il tasto menu . Il display visualizza ora il messaggio **RUBRICA**.
2. Premere nuovamente il tasto . Il display visualizza ora il messaggio **AGGIUNGI**.
3. Confermare nuovamente con il tasto menu . Il display visualizza ora il messaggio **NOME?**.
4. Digitare a questo punto il nome desiderato (massimo 12 lettere) attraverso la tastiera numerica. Le informazioni inerenti all'immissione dei nomi sono da apprendere al prossimo paragrafo.
5. Confermare il nome desiderato con il tasto menu . Il display visualizza ora il messaggio **NUMERO ?**.
6. Digitare il numero di telefono desiderato attraverso la tastiera numerica.
7. Confermare nuovamente con il tasto menu . Il display visualizza ora il messaggio **MELODIE 1 - 3**.
8. Selezionare a questo punto attraverso i tasti di selezione  e , quale melodia desiderate assegnare a questo numero telefonico.
9. Confermare nuovamente con il tasto menu . Il display visualizza ora il messaggio **AGGIUNGI**.
10. Se desiderate memorizzare ulteriori numeri telefonici, dovete proseguire con il punto 3. Mantenendo premuto il tasto , potete abbandonare il livello d'immissione.

Nota sulla rubrica telefonica!

- Ogni numero telefonico memorizzato può essere inoltre assegnato ad una delle tre melodie di chiamata. In tal modo potete riconoscere direttamente dalla melodia chi sta attualmente chiamando. Questa assegnazione funziona solamente se il vostro allacciamento telefonico e anche quello dell'interlocutore supporta la funzione di indicazione del numero telefonico CLIP. **In Svizzera non tutti i gestori di reti di comunicazione offrono questa funzione.** Le ulteriori informazioni sono da apprendere al capitolo 6.
- Digitare in tutti i numeri telefonici sempre il prefisso, affinché il telefono possa anche assegnare le chiamate locali ad una voce nella rubrica telefonica.
- Quando avete raggiunto la capacità di memorizzazione dei 30 numeri telefonici, alla prossima memorizzazione di un numero nel display viene visualizzato il messaggio **MEMORIA COMPLETA**. In questo caso sarà innanzitutto necessario cancellare degli altri numeri telefonici meno importanti, per liberare nuovo spazio di memoria.

SUGGERIMENTO! La rubrica telefonica può essere visualizzata anche durante una conversazione ancora in corso.

Premere a tal fine il tasto  e selezionare come di consueto una voce. Il tasto menu  mostra il numero telefonico memorizzato (premere due volte in caso di oltre 12 posizioni). Premendo nuovamente il tasto menu



 si ritorna di nuovo alla rubrica telefonica.

Spiegazione della modalità d'immissione dei nomi

Per l'immissione dei nomi i tasti numerici sono anche previsti con delle lettere. Premendo ripetutamente il rispettivo tasto, potete digitare lettere in maiuscolo nonché cifre.



Esempio: Volete digitare il nome "Peter".

Premere: 1 x il tasto 7, 2 x il tasto 3, 1 x il tasto 8, 2 x il tasto 3 e 3 x il tasto 7











- Per immettere uno spazio, occorre premere una volta il tasto .
- Premendo due volte il tasto , si può inserire anche un trattino.
- Per immettere due volte la stessa lettera, occorre premere le rispettive lettere ed attendere successivamente, finché il cursore passa automaticamente avanti di una posizione.
- Le immissioni sbagliate possono essere nuovamente cancellate tramite il tasto .

- La rubrica telefonica -

5.2 Modifica dei numeri memorizzati nella rubrica telefonica

1. Premere il tasto menu . Nel display viene visualizzato **RUBRICA**.
2. Premere nuovamente il tasto . Nel display viene visualizzato **AGGIUNGI**.
3. Premere a questo punto il tasto . Nel display viene visualizzato **MODIFICARE**.
4. Confermare nuovamente con il tasto menu . A questo punto nel display vengono visualizzati in ordine alfabetico i numeri telefonici memorizzati.
5. Selezionare adesso tramite i tasti  e  il numero che desiderate modificare.
6. Confermare la selezione con il tasto menu . Nel display viene visualizzato nuovamente il nome. A questo punto dietro l'ultima lettera lampeggia anche il cursore.
7. Modificare a questo punto il nome desiderato attraverso la tastiera numerica. Le informazioni inerenti all'immissione dei nomi sono da apprendere al capitolo 5.1.
8. Una volta completate le modifiche desiderate, è necessario confermare ancora una volta con il tasto menu  le impostazioni effettuate. A questo punto nel display viene visualizzato il numero telefonico.
9. Modificare a questo punto il numero telefonico desiderato attraverso la tastiera numerica. Premendo ripetutamente il tasto , potete cancellare le singole cifre del numero telefonico.
10. Una volta completate le modifiche desiderate, è necessario confermare ancora una volta con il tasto menu  le impostazioni effettuate. Il display visualizza ora il messaggio **MELODIE**.
11. Selezionare a questo punto attraverso i tasti di selezione  e , quale melodia desiderate assegnare a questo numero telefonico.
12. Una volta completate le modifiche desiderate, è necessario confermare ancora una volta con il tasto menu  le impostazioni effettuate. Il display visualizza ora il messaggio **MODIFICARE**.
13. Se desiderate modificare ulteriori numeri telefonici, dovete proseguire con il punto 4. Mantenendo premuto il tasto , potete abbandonare il livello di programmazione.

5.3 Cancellazione del numero di telefono dalla rubrica telefonica

1. Premere il tasto menu . Nel display viene visualizzato **RUBRICA**.
2. Premere nuovamente il tasto . Nel display viene visualizzato **AGGIUNGI**.
3. Premere a questo punto il tasto . Nel display viene visualizzato **CANCELLARE**.
4. Confermare ora con il tasto menu .
5. Selezionare adesso tramite i tasti  e  il numero telefonico che desiderate cancellare.
6. Una volta che avete trovato il numero telefonico desiderato, è necessario confermare ancora una volta con il tasto menu  la selezione dello stesso e sul display viene quindi visualizzato il messaggio **CONFERMA?**.
7. Confermare nuovamente la selezione con il tasto menu . In seguito a ciò il numero telefonico viene cancellato dalla rubrica telefonica. Il display visualizza di nuovo il messaggio **CANCELLARE**. Mantenendo premuto il tasto , potete interrompere il procedimento di cancellazione.
8. Dopo che avete cancellato il numero telefonico, nel display verrà visualizzato il messaggio **CANCELLARE**. Se desiderate cancellare ulteriori numeri telefonici, dovete proseguire con il punto 4. Mantenendo premuto il tasto , potete abbandonare il livello di cancellazione.

6 Indicazione del numero degli interlocutori (CLIP)

In Svizzera non tutti i gestori di reti di comunicazione offrono questa funzione.



Attenzione! L'indicazione del numero degli interlocutori è un servizio opzionale della Vostra società telefonica. Il Vostro telefono visualizza il numero telefonico nel display, purché la Vostra società telefonica offra questo servizio. L'indicazione della data e dell'ora non viene trasmessa da tutte le società telefoniche. Richiedete ulteriori informazioni al Vostro consulente telefonico. Anche in alcuni impianti interni di centralino la trasmissione del numero telefonico o della data e dell'ora non è possibile.



Grazie all'indicazione del numero degli interlocutori potete subito riconoscere da chi provengono le chiamate in arrivo. Se questa funzione è disponibile nel Vostro allacciamento telefonico, non appena squilla il telefono, nel display viene immediatamente visualizzato il numero telefonico della persona che chiama.

Se avete memorizzato questo numero di telefono nella Vostra rubrica telefonica, al posto del numero verrà indicato il nome dell'interlocutore. Inoltre, nella rubrica telefonica ogni numero telefonico memorizzato può essere assegnato ad una delle tre melodie di chiamata, in modo che possiate riconoscere subito dalla melodia chi sta chiamando.

Tutte le telefonate vengono memorizzate in una rispettiva lista, in modo tale da non perdere nessuna chiamata neanche durante l'assenza. Complessivamente possono essere memorizzati 30 numeri telefonici nella lista. Non appena la lista è piena, verrà sempre cancellato rispettivamente l'ultimo numero della lista, cioè quello più vecchio. Se durante la Vostra assenza è stato memorizzato un nuovo numero telefonico nella lista delle chiamate, nel display lampeggia il simbolo .

6.1 La lista delle chiamate

Per vedere il numero telefonico dell'interlocutore nel display, occorre procedere nel modo seguente:

1. Premere il tasto  ed il numero ricevuto per ultimo viene visualizzato nel display. Se la lista delle chiamate è vuota, nel display verrà visualizzato il messaggio **MEM VUOTA**.
2. Tramite i tasti  e  potete ora chiamare ulteriori numeri telefonici memorizzati nella lista delle chiamate. Se non sono presenti alcuni ulteriori numeri, si sente un segnale acustico. Due simboli sul display informano se la telefonata è stata ricevuta o meno.





=> Questa telefonata non è stata ricevuta.



=> Questa telefonata è stata ricevuta.

Note: Tramite il tasto menu  potete richiamare delle informazioni.

- Se il numero telefonico dovesse essere più lungo di 12 posizioni, allora verranno indicate soltanto le cifre rimanenti.
- Indica il numero telefonico, se l'interlocutore è già stato memorizzato nella rubrica telefonica con il nome.
- Indica la data e l'ora, se questi dati sono stati trasmessi dall'interlocutore.
- Se non sono disponibili alcuni ulteriori dati, sul display verrà visualizzato il messaggio **AGGIUNGI ?**.
- Tramite il tasto  potete ritornare in qualsiasi momento alla lista.











3. Se desiderate richiamare direttamente un numero telefonico dalla lista delle chiamate, basta premere semplicemente il tasto di conversazione  ed il numero viene immediatamente chiamato.

4. Mantenendo premuto il tasto , potete abbandonare la lista delle chiamate.

- **Indicazione del numero degli interlocutori CLIP** -







6.2 Memorizzazione dei numeri telefonici dalla lista delle chiamate nella rubrica telefonica

Un numero telefonico memorizzato nella lista delle chiamate può essere direttamente salvato nella rubrica telefonica.





1. Premere il tasto  ed il numero ricevuto per ultimo viene visualizzato nel display.
2. Tramite i tasti  e  potete ora comporre i numeri telefonici della lista delle chiamate che volete memorizzare nella rubrica telefonica.
3. Premere ripetutamente il tasto , finché nel display non viene visualizzato il messaggio **AGGIUNGI ?**.
4. Confermare nuovamente con il tasto menu . Il display visualizza ora il messaggio **NOME?**.
5. Digitare a questo punto il nome desiderato (massimo 12 lettere) attraverso la tastiera numerica.
6. Confermare nuovamente la selezione con il tasto menu . In seguito a ciò il numero telefonico viene visualizzato ancora una volta sul display.
7. Confermare nuovamente con il tasto menu . Il display visualizza ora il messaggio **MELODIE 1 - 3**.
8. Selezionare a questo punto attraverso i tasti di selezione  e , quale melodia desiderate assegnare a questo numero telefonico.
9. Confermare nuovamente la selezione con il tasto menu . In seguito a ciò il numero telefonico viene memorizzato nella rubrica telefonica.

Nota: Non appena il numero telefonico viene memorizzato nella rubrica telefonica con un nome, nella lista delle chiamate non apparirà più il numero telefonico, bensì il rispettivo nome memorizzato.

6.3 Cancellazione di singoli numeri telefonici dalla lista delle chiamate



1. Premere il tasto  ed il numero ricevuto per ultimo viene visualizzato nel display.
2. Tramite i tasti  e  potete ora comporre i numeri telefonici della lista delle chiamate che volete cancellare.
3. Premere il tasto . Il display visualizza ora il messaggio **CANCELLARE ?**.
4. Confermare nuovamente con il tasto menu , per cancellare quindi il numero telefonico dalle lista delle chiamate oppure uscire dal modo di cancellazione, mantenendo premuto il tasto .

6.4 Cancellazione dell'intera lista delle chiamate

1. Premere il tasto  ed il numero della lista delle chiamate ricevuto per ultimo viene visualizzato nel display.
2. Mantenere premuto il tasto , finché sul display non viene visualizzato il messaggio **CANC TUTTO?**.
3. Confermare nuovamente con il tasto menu , per cancellare quindi la lista delle chiamate oppure uscire dal modo di cancellazione, mantenendo premuto il tasto .



7 Funzioni speciali

Tutte le altre funzioni di programmazione sono accessibili attraverso un menu molto facile da usare. Qui Vi illustriamo una piccola guida generale su come potete muovervi nel menu:

Tramite il tasto  potete avviare il livello di programmazione. Durante la programmazione lampeggia l'indicazione  nel display.

Mediante i tasti  e  potete selezionare il livello desiderato.

Questo livello viene aperto con il tasto .

Dopodiché con i tasti  e  potete nuovamente selezionare la funzione desiderata, per poi confermarla di nuovo con il tasto menu .

Tramite il tasto  potete ritornare rispettivamente indietro di un livello.











Ogni procedimento di memorizzazione viene automaticamente annullato, se entro i prossimi 15 secondi non viene più premuto un tasto.

Mantenendo premuto il tasto , potete di nuovo uscire in qualsiasi momento dal livello di programmazione, senza effettuare alcune modifiche.

Al capitolo 7.13 vi è riportata una completa panoramica del menu.











7.1 Regolazione dei segnali di chiamata nell'unità portatile (melodie della suoneria)

La vostra unità portatile può segnalare le chiamate dall'esterno con tre melodie diverse degli squilli. Se impiegate il sistema telefonico con parecchie unità portatili, per le telefonate esterne ed interne potete impostare diverse melodie per i segnali di chiamata.

1. Premere il tasto menu .
2. Selezionare il menu **PORTATILE** mediante i tasti  e  e confermare successivamente con il tasto .
3. Selezionare ora tramite i tasti  e  la funzione **MELODIA EXT** (segnale di chiamata per telefonate esterne) oppure **MELODIA INT** (segnale di chiamata per telefonate interne / solo con due unità portatili) e confermare successivamente con il tasto .
4. Selezionare a questo punto la melodia desiderata tramite i tasti  e  e confermare successivamente con il tasto .
5. Selezionate adesso ulteriori funzioni menu oppure uscite dal menu, mantenendo premuto il tasto .

7.2 Volume del segnale di chiamata dell'unità portatile

Il volume del segnale di chiamata dell'unità portatile può essere regolato in tre stadi. Se qualche volta desiderate non essere disturbati, potete anche disinserire completamente il segnale di chiamata. Se avete disinserito il segnale di chiamata, le telefonate in arrivo vengono segnalate acusticamente soltanto nella stazione base e per mezzo del display dell'unità portatile.

1. Premere il tasto menu .
2. Selezionare il menu **PORTATILE** mediante i tasti  e  e confermare successivamente con il tasto .
3. Selezionare ora tramite i tasti  e  la funzione **VOL SUON INT** (volume per telefonate esterne) oppure **VOL SUON EXT** (volume per telefonate interne / solo con due unità portatili) e confermare successivamente con il tasto .
4. Selezionare a questo punto il volume desiderato tramite i tasti  e  oppure disinserire il segnale di chiamata con **SILENZIO** e confermare successivamente con il tasto .
5. Selezionate adesso ulteriori funzioni menu oppure uscite dal menu, mantenendo premuto il tasto .

- Funzioni speciali -











7.3 Regolazione dei segnali di chiamata nella stazione base (melodie della suoneria)

Anche la stazione base può segnalare le chiamate dall'esterno con cinque diverse melodie di suoneria all'arrivo di una telefonata.

1. Premere il tasto menu .
2. Selezionare il menu **CONFIGURARE** tramite i tasti  e  e confermare successivamente con il tasto .
3. Selezionare a questo punto la funzione **MELODIE BASE** tramite i tasti  e  e confermare successivamente con il tasto .
4. Selezionare a questo punto la melodia desiderata tramite i tasti  e  e confermare successivamente con il tasto .
5. Selezionate adesso ulteriori funzioni menu oppure uscite dal menu, mantenendo premuto il tasto .







7.4 Volume del segnale di chiamata della stazione base

Il volume del segnale di chiamata della stazione base può essere regolato in tre livelli. Se qualche volta desiderate non essere disturbati, potete anche disinserire completamente il segnale di chiamata.

1. Premere il tasto menu .
2. Selezionare il menu **CONFIGURARE** tramite i tasti  e  e confermare successivamente con il tasto .
3. Selezionare a questo punto la funzione **VOLUME BASE** tramite i tasti  e  e confermare successivamente con il tasto .
4. Selezionare a questo punto il volume desiderato tramite i tasti  e  oppure disinserire il segnale di chiamata con **SILENZIO** e confermare successivamente con il tasto .
5. Selezionate adesso ulteriori funzioni menu oppure uscite dal menu, mantenendo premuto il tasto .











7.5 Ricezione automatica delle chiamate

Le chiamate dall'esterno vengono ricevute automaticamente, non appena sollevate l'unità portatile dalla stazione base. Se invece desiderate ricevere le telefonate solo tramite il tasto , allora potete disinserire la funzione di ricezione automatica delle chiamate.

1. Premere il tasto menu .
2. Selezionare il menu **PORTATILE** mediante i tasti  e  e confermare successivamente con il tasto .
3. Selezionare a questo punto la funzione **RISPOSTA AUT** tramite i tasti  e  e confermare successivamente con il tasto .
4. Selezionare il **ATTIVA** oppure **DISATTIVA** tramite i tasti  e  e confermare successivamente con il tasto .
5. Selezionate adesso ulteriori funzioni menu oppure uscite dal menu, mantenendo premuto il tasto .

7.6 Modalità di selezione a FREQUENZE oppure ad IMPULSI











Questa proprietà avveniristica permette di utilizzare il Vostro telefono sia nei centralini analogici (selezione ad IMPULSI/DC), che nei moderni centralini digitali (selezione a TONI/MF). In fabbrica è stata impostata la modalità di selezione a TONI/MF.

1. Premere il tasto menu .
2. Selezionare il menu **CONFIGURARE** tramite i tasti  e  e confermare successivamente con il tasto .
3. Selezionare a questo punto la funzione **TIPO SELEZ** tramite i tasti  e  e confermare successivamente con il tasto .
4. Selezionare il menu la modalità di selezione desiderata tramite i tasti  e  e confermare successivamente con il tasto .
5. Selezionate adesso ulteriori funzioni menu oppure uscite dal menu, mantenendo premuto il tasto .

- Funzioni speciali -

7.7 Modifica dei nomi nel display

Nel funzionamento normale il display visualizza l'indicazione „D6025“. Se avete registrato parecchie unità portatili ad una stazione base, può essere utile assegnare ad ogni unità portatile un nome proprio. Il numero dietro il nome indica con quale numero potete raggiungere la rispettiva unità portatile per le chiamate interne.

1. Premere il tasto .
2. Selezionare il menu **PORTATILE** mediante i tasti  e  e confermare successivamente con il tasto .
3. Selezionare ora la funzione **NOME** tramite i tasti  e  e confermare successivamente con il tasto .
4. Digitare a questo punto il nome desiderato attraverso la tastiera numerica. Premendo ripetutamente il tasto , potete cancellare le singole lettere che sono già state immesse.
5. Confermare con il tasto .
6. Selezionate adesso ulteriori funzioni menu oppure uscite dal menu, mantenendo premuto il tasto .

7.8 Attivazione / disattivazione dei segnali acustici d'avvertimento

Qui potete attivare ossia disattivare i diversi segnali acustici d'avvertimento.

Clic dei tasti

Ogni volta che premete un tasto, nell'unità portatile sentite un segnale acustico, detto clic tasti. Questo cosiddetto clic dei tasti può essere naturalmente inserito oppure disinserito, a piacere.

Segnale d'avvertimento in caso di capacità insufficiente delle batterie

Nel caso di una capacità insufficiente delle batterie, un rispettivo segnale acustico d'avvertimento Vi segnala la necessità di ricaricare le batterie dell'unità portatile.

Avvertimento in caso di superamento del raggio d'azione











Quando Vi allontanate eccessivamente dalla stazione base, un rispettivo segnale acustico d'avvertimento Vi segnala, che state per perdere il contatto con la stazione base.

1. Premere il tasto menu .
2. Selezionare il menu **PORTATILE** mediante i tasti  e  e confermare successivamente con il tasto .
3. Selezionare a questo punto la funzione **BIP** tramite i tasti  e  e confermare successivamente con il tasto .
4. Selezionare ora le funzioni **BIP TASTI**, **BATT SCARICA** oppure **FUORIPORTATA** tramite i tasti  e  e confermare successivamente con il tasto .
5. Attivare ossia disattivare ora il segnale acustico d'avvertimento selezionato tramite i tasti  e  e confermare successivamente con il tasto .
6. Selezionate adesso ulteriori funzioni menu oppure uscite dal menu, mantenendo premuto il tasto .

7.9 Modifica del codice PIN











Alcune funzioni del sistema telefonico sono protette per mezzo di un codice PIN contro l'uso non autorizzato. Il codice PIN consiste di quattro cifre. In fabbrica è stato preimpostato il codice PIN "0000". Per modificare il codice PIN occorre procedere nel modo seguente:

- Funzioni speciali -

1. Premere il tasto menu .
2. Selezionare il menu **CONFIGURARE** tramite i tasti  e  e confermare successivamente con il tasto .
3. Selezionare ora la funzione **CODICE PIN** tramite i tasti  e  e confermare successivamente con il tasto .
4. Digitare a questo punto il codice PIN attuale con quattro posizioni attraverso la tastiera numerica (impostazione di fabbrica "0 0 0 0") e confermare successivamente con .
5. Digitare ora il nuovo codice PIN con quattro posizioni attraverso la tastiera numerica e confermare successivamente con .
6. Per confermare definitivamente l'impostazione, è necessario digitare ancora una volta il nuovo codice PIN con quattro posizioni attraverso la tastiera numerica e confermare successivamente con .
7. Selezionate adesso ulteriori funzioni menu oppure uscite dal menu, mantenendo premuto il tasto . In un'immissione sbagliata del codice PIN il procedimento di programmazione viene automaticamente annullato.

7.10 Selezione della lingua nel display

Le visualizzazioni del display possono essere selezionate nelle lingue tedesco, italiano, spagna, netherlands, inglese e francese, nonché danese, norvegese e svedese.

1. Premere il tasto menu .
2. Selezionare il menu **PORTATILE** mediante i tasti  e  e confermare successivamente con il tasto .
3. Selezionare ora la funzione **LINGUA** tramite i tasti  e  e confermare successivamente con il tasto .
4. Selezionare a questo punto la lingua desiderata tramite i tasti  e  e confermare successivamente con il tasto .
5. Mantenendo premuto il tasto , potete abbandonare il livello d'immissione.

7.11 Regolazione del periodo FLASH

1. Premere il tasto menu .
2. Selezionare il menu **CONFIGURARE** tramite i tasti  e  e confermare successivamente con il tasto .
3. Selezionare a questo punto la funzione **TASTO R** tramite i tasti  e  e confermare successivamente con il tasto .
4. Selezionare a questo punto tramite i tasti  e  il periodo **TEMPO FLASH 1** (90ms) oppure **TEMPO FLASH 2** (250ms) e confermare successivamente con il tasto .
5. Mantenendo premuto il tasto , potete abbandonare il livello d'immissione.









7.12 Ripristino alle impostazioni di fabbrica

Mediante questa funzione potete ripristinare l'unità portatile e la stazione base nuovamente allo stato di consegna. Con il ripristino vengono cancellati la rubrica telefonica, la lista delle chiamate (CLIP) e tutti i numeri telefonici memorizzati nella funzione di ripetizione delle chiamate.





Impostazioni di fabbrica:

lingua: tedesco	nome dell'unità portatile: D6025
segnale d'avvertimento batterie: ON	ricezione automatica delle chiamate ON
segnale d'avvertimento raggio d'azione: ON	melodia del segnale di chiamata esterna: 3
clic dei tasti: ON	melodia del segnale di chiamata interna: 1
volume della cornetta: 3	volume del segnale di chiamata dell'unità portatile: 3
codice PIN: 0 0 0 0	melodia del segnale di chiamata della base: 2
pausa: 3 sec.	volume del segnale di chiamata della base: 3
modalità di selezione: MF/DC	periodo FLASH 90ms

- Funzioni speciali -

1. Premere il tasto menu .
2. Selezionare il menu **CONFIGURARE** tramite i tasti  e  e confermare successivamente con il tasto .
3. Selezionare ora la funzione **SETTAGGI STD** tramite i tasti  e  e confermare successivamente con il tasto .
4. Digitare il codice PIN attraverso la tastiera numerica (impostazione di fabbrica 0000) e confermare successivamente con il tasto . A questo punto viene visualizzato il messaggio **CONFERMA?**.
5. Confermare ora con il tasto menu .
6. Dopo breve tempo le impostazioni vengono ripristinate allo stato di consegna. Nel display viene visualizzato nuovamente il normale modo di disponibilità.

Nota: Se avete dimenticato sbadatamente il codice PIN, le impostazioni di fabbrica potranno essere ripristinate anche senza il codice PIN.

1. Rimuovere una batteria dall'unità portatile.
2. Mantenere premuto il tasto  e introdurre di nuovo la batteria. Mantenere premuto il tasto , finché sul display non viene visualizzato il messaggio **SETTAGGI STD**.
3. Confermare con il tasto  per ripristinare di nuovo le impostazioni di fabbrica. Tramite il tasto  potete annullare in qualsiasi momento la programmazione.

7.13 Struttura del menu

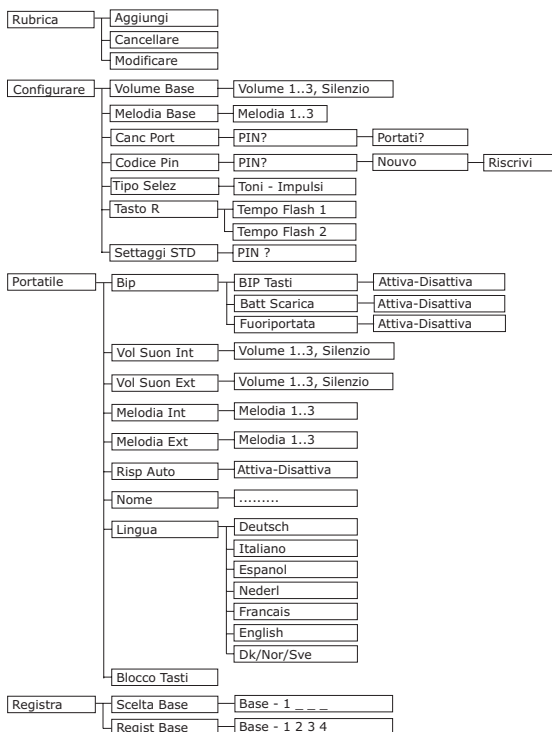

8 Parecchie unità portatili

Alla Vostra stazione base potete registrare fino ad una unità portatili.

Nota: Grazie alla normativa internazionale GAP standard potete integrare nel Vostro sistema telefonico delle unità portatili di altri produttori. Altrettanto potete collegare un'unità portatile *SWITEL* a stazioni base di altri produttori, per quanto siano previste per funzionare con la modalità GAP standard.



Nell'impiego di parecchie unità portatili avete le possibilità seguenti:

- conversazioni interne e gratuite tra le unità portatili
- le conversazioni esterne possono essere deviate tra le singole unità portatili.
- le telefonate in arrivo dall'esterno possono essere segnalate in tutte le unità portatili.

Avvertenza: Se momentaneamente un'altra unità portatile sta utilizzando la linea esterna, in tutte le altre unità portatili si illumina la spia di controllo della cornetta. In questo caso non saranno possibili ulteriori conversazioni esterne.

8.1 Telefonate interne

Se avete collegato parecchie unità portatili ad una stazione base, potete anche fare delle telefonate interne.

Premere a tal fine il tasto  e dopodiché il numero dell'unità portatile desiderata. La telefonata viene ricevuta, premendo il tasto di conversazione  nell'unità portatile chiamata.

8.2 Deviazione delle telefonate esterne ad un'altra unità portatile









Se avete ricevuto una telefonata esterna in un'unità portatile, potete anche deviarla ad un'altra unità portatile integrata nel sistema telefonico. Premere a tal fine il tasto  e dopodiché il numero dell'unità portatile desiderata. Dopo aver ricevuto la telefonata interna nell'altra unità portatile, avete le possibilità seguenti:

A. Conferire / intermediare: A questo punto potete parlare con l'utente interno e ricommutare successivamente all'utente esterno, premendo il tasto . In questo modo potete commutare con una frequenza a piacere tra conversazione esterna ed interna.

B. Deviazione delle telefonate: La telefonata esterna viene deviata, premendo il tasto di conversazione  nella prima unità portatile chiamata.

8.3 Registrazione e deregistrazione di unità portatili

8.3.1 Registrazione di unità portatili

1. Mantenere premuto il tasto **PAGE**  della stazione base per 10 secondi, fino a sentire due segnali acustici. A questo punto è necessario registrare la nuova unità portatile entro 90 secondi alla stazione base.
2. Premere il tasto  nell'unità portatile.
3. Selezionare il menu **REGISTRA** tramite i tasti  e  e confermare successivamente con il tasto .
4. Selezionare il menu **REG BASE** tramite i tasti  e  e confermare successivamente con il tasto .
5. Digitare a questo punto il numero della stazione base (1 - 4) attraverso la tastiera numerica. Se l'unità portatile è già collegata ad una stazione base, allora lampeggiano i rispettivi numeri ad essa assegnati.
6. Confermare l'immissione con il tasto menu .
7. Digitare a questo punto il codice PIN della stazione base (impostazione di fabbrica „0 0 0 0“).
8. Confermare l'immissione con il tasto  e dopo alcuni secondi si sente un segnale acustico. A questo punto l'unità portatile è registrata e potrà essere impiegata sia per le conversazioni esterne che interne.
9. All'unità portatile è stato ora assegnato un numero interfonico. L'unità portatile già registrata ha il numero interno 1, mentre la seconda unità portatile registrata ottiene il numero interno 2. Questo numero interfonico verrà poi visualizzato nel display a destra affianco al nome.

- **Parecchie unità portatili** -

8.3.2 Registrazione di altri telefoni DECT-GAP alla stazione base

Per registrare un'unità portatile DECT-GAP, consultate le istruzioni per l'uso del rispettivo produttore e mantenere successivamente premuto per 6 secondi il tasto  sulla stazione base. Per la registrazione occorre digitare il codice PIN 0 0 0 0.

8.3.3 Deregistrazione di unità portatili

Un'unità portatile può essere deregistrata soltanto attraverso un'altra unità portatile ancora registrata. Perciò non è possibile eseguire questa deregistrazione con l'unità portatile da voler deregistrare.











1. Premere il tasto  nell'unità portatile.
2. Selezionare il menu **CONFIGURARE** tramite i tasti  e  e confermare successivamente con il tasto .
3. Selezionare ora la funzione **CANC PORT** tramite i tasti  e  e confermare successivamente con il tasto .
4. Digitare a questo punto il codice PIN della stazione base (impostazione di fabbrica "0 0 0 0") e confermare successivamente con il tasto .
5. Selezionare a questo punto il numero dell'unità portatile da deregistrare 1 o 2 e confermare successivamente con il tasto . Tramite il tasto  potete annullare in qualsiasi momento la programmazione. Dopo la corretta deregistrazione si sente un rispettivo segnale acustico di conferma. A questo punto l'unità portatile è deregistrata e non potrà più essere impiegata né per le conversazioni esterne né interne.

8.4 Stazioni base supplementari

Nell'impiego di parecchie stazioni base potete aumentare notevolmente il raggio d'azione delle unità portatili integrate nel Vostro sistema telefonico. Per poter sfruttare questo effetto, è necessario che tutte le stazioni base siano collegate ad un allacciamento telefonico. A seconda della modalità e scopo d'impiego potete occupare ogni stazione base con lo stesso numero telefonico oppure assegnare alle stazioni base diversi numeri telefonici. Accertarsi che tutte le stazioni base siano in contatto reciproco entro il loro raggio d'azione. Prima di ogni messa in funzione di una nuova stazione base si consiglia di effettuare un test del raggio d'azione dell'unità portatile.

Se avete registrato un'unità portatile alle stazioni base, e nell'attivazione della funzione di selezione automatica della stazione base (ulteriori informazioni in questo capitolo), l'unità portatile verrà sempre deviata automaticamente alla prossima stazione base. Le **conversazioni in corso non possono** essere trasmesse da una stazione base all'altra.

Selezione di una stazione base

1. Premere il tasto  nell'unità portatile.
2. Selezionare il menu **REGISTRA** tramite i tasti  e  e confermare successivamente con il tasto .
3. Selezionare il menu **SCelta BASE** tramite i tasti  e  e confermare successivamente con il tasto .
4. A questo punto il display indica tutte le stazioni base, alle quali è già stata registrata l'unità portatile. Dopodiché lampeggia il numero della stazione base appena attiva. Selezionare attraverso la tastiera numerica la stazione base desiderata, alla quale dover commutare l'unità portatile.
Oppure commutare attraverso i tasti  e  all'impostazione **AUTO**. In questa impostazione l'unità portatile commuta automaticamente alla prossima stazione base, nel caso in cui il collegamento alla stazione base attuale sia troppo debole.
5. Confermare tramite il tasto .

9 Rimedio in caso di errori

Nel caso di eventuali complicazioni con il Vostro telefono, si prega di attenersi innanzitutto alle seguenti istruzioni. Per le richieste di garanzia Vi preghiamo di rivolgerVi al Vostro rivenditore di fiducia. La validità della garanzia corrisponde a 2 anni. Per le batterie ricaricabili si concede una garanzia di 12 mesi.

Nessuna possibilità di conversazione	La linea telefonica non è correttamente collegata oppure è disturbata. Utilizzare esclusivamente il cavo telefonico fornito in dotazione. Eseguire un test con un altro telefono, per verificare il funzionamento corretto del Vostro allacciamento telefonico. L'alimentatore di rete non è correttamente inserito nella presa di corrente o mancanza totale di corrente (black-out). Le batterie ricaricabili sono difettose oppure esaurite. Vi siete allontanati eccessivamente dalla stazione base.
Collegamento interrotto, avaria	Vi siete allontanati eccessivamente dalla stazione base. Luogo d'installazione della stazione base non ottimale.
Nessuna possibilità di selezione	Regolazione erronea della modalità di selezione (si veda al capitolo 7.6).
Il sistema non reagisce più o si trova in uno stato indefinito.	Ripristinare tutte le funzioni allo stato di consegna. Estrarre prima l'alimentatore di rete dalla presa di corrente per breve tempo. Per l'impostazione di fabbrica si veda al capitolo 7.12.
La spia di controllo del procedimento di carica non si illumina.	Appoggiare correttamente l'unità portatile sulla stazione base, pulire le superfici di contatto dell'unità portatile e della stazione base con un panno morbido ed asciutto.
Dopo un paio d'ore nel display lampeggia il simbolo della batteria.	Appoggiare l'unità portatile sulla stazione base per la durata di almeno 10 ore. Nel caso ciò non fosse il rimedio, occorre cambiare le batterie ricaricabili.
Indicazione scura del display	La causa è da attribuire ad una diretta esposizione ai raggi solari, lasciare raffreddare l'unità portatile.

10 Dati tecnici

Standard	DECT
Numero canale	1880 fino 1990 MHz
Alimentazione di corrente	stazione base 220/230V, 50 Hz
Raggio d'azione	in edifici fino a 50m
Raggio d'azione	all'aperto fino a 300m
Standby	fino a 100 ore
Max. durata di conversazione	fino a 10 ore
Batterie ricaricabili	2 x 1,2V/550mA, tipo AAA
Modalità di selezione	MF oppure DC
Temperatura ambientale ammessa	10°C fino 30°C
Relativa umidità d'aria ammessa	20 fino 75%
Funzione dei tasti di segnalazione	90ms, 250ms

- Contents -

1	General Information.....	64	7	Special functions	75
2	User controls.....	65	7.1	Setting the ring tone on the handset (ring melodies)	75
3	Setting up	66	7.2	Ring tone volume on the handset.....	75
3.1	Safety information	66	7.3	Setting the ring tones on the base station (ring melodies)	76
3.2	Check contents of pack	66	7.4	Ring tone volume on the base station	76
3.3	Connecting the base station	66	7.5	Accepting calls automatically	76
3.4	Fitting standard batteries	66	7.6	Tone (TD) or pulse (PD) dialling	76
3.5	Charging the standard batteries	66	7.7	Changing display names.....	76
4	Operation	67	7.8	Activating/Deactivating warning tones	77
4.1	The display	67	7.9	Changing the PIN code	77
4.2	Receiving calls	67	7.10	Setting the display language.....	78
4.3	Making calls	68	7.11	Setting the FLASH time	78
4.4	Dialling stored numbers from the phone book	68	7.12	Restoring factory settings.....	78
4.5	Call duration display	68	7.13	Menu structure	79
4.6	Switching the handset on and off.....	68	8	Multiple handsets.....	80
4.7	Range information	68	8.1	Making an internal call.....	80
4.8	Muting the microphone in the handset.....	69	8.2	Connecting external calls to another handset	80
4.9	Adjusting the receiver volume.....	69	8.3	Logging on and logging off handsets	80
4.10	Redial facility	69	8.3.1	Logging on handsets	80
4.11	Keypad lock	69	8.3.2	Logging on other DECT-GAP telephones to the base station	81
4.12	Temporary tone dialling.....	70	8.3.3	Logging off handsets	81
4.13	Paging from the base station to the handset	70	8.4	Additional base stations	81
4.14	Private exchanges	70	9	Troubleshooting.....	82
4.15	Using Pause.....	70	10	Technical data	82
5	The phone book.....	71			
5.1	Entering numbers in the phone book.....	71			
5.2	Changing numbers stored in the phone book	72			
5.3	Deleting stored numbers from the phone book	72			
6	Caller display (CLID).....	73			
6.1	The caller list	73			
6.2	Storing telephone numbers from the Caller List in the phone book.....	74			
6.3	Deleting individual telephone numbers from the caller list	74			
6.4	Deleting the entire Caller List.....	74			

1 General Information

Rechargeable Batteries - Do not use any other rechargeable batteries or power packs. These could possibly cause a short circuit. When changing batteries, always use standard **rechargeable** batteries, type AAA 1.2V 550 mAh. Do not throw standard batteries into open fire or immerse in water. Do not dispose of old or defective standard batteries together with normal domestic waste. Warming up of the handset during recharging is normal and does not impose any danger. Do not use battery chargers from other manufacturers to charge the handset, as this could lead to damage.

Position - There should be a 230 Volt mains socket near the position of the telephone. Do not place the base station in the immediate vicinity of other electrical equipment, such as microwaves or hi-fi systems, as this may result in mutual interference. The position has a decisive effect on problem free operation of the telephone. Place the base station on a flat and skidproof surface. The feet of the base station normally do not leave any marks on the surface. However, due to the large number of varnishes and surfaces in use, it is not always possible to avoid such foot prints on the telephone resting surface. Do not use the handset in explosion endangered environments. Excessive exposure to smoke, dust, vibrations, chemicals, moisture, heat or direct sun radiation must be avoided.

Information on Medical Equipment - The telephone works with a very low transmission power. According to the current state of research and technology this low transmission power rules out any health risk. However, it has become apparent that switched on portable telephones can interfere with medical equipment. Therefore, please keep a safe distance of at least one metre from medical equipment.

Waste Disposal - If the working life of the rechargeable batteries or the complete equipment has expired, please dispose of these items in an environmentally friendly manner and in accordance with the statutory provisions.

Temperature and Ambient Conditions - The telephone has been designed for use in protected rooms with a temperature range of 10 °C to 30 °C. The base station must not be installed in damp rooms, such as a bathroom or laundry room. Avoid the proximity to heat sources like radiators and do not expose the unit to direct sunlight.

Cleaning and Care

The surface of the case can be cleaned with a soft, dry and lint-free cloth. Do not use cleansing agents, particularly aggressive solvents. Apart from occasional cleaning of the case no other care is required. The rubber feet of the base station are not resistant to all types of cleansers. The manufacturer will therefore not assume liability for possible damage to furniture or the like.

2 User controls

Handset

- 1 Call indicator
- 2 Redial
- 3 Menu and confirm button
- 4 Selection buttons/Caller list CLID
- 5 Phone book/Exit menu
- 6 Internal calls
- 7 R signal button/on-off handset
- 8 Key pad lock
- 9 Call button
- 10 Mute button/Delete

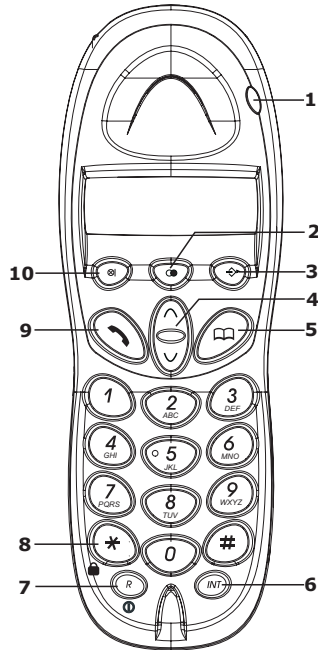

Base station

- 1 PAGE button
- 2 Charge monitoring lamp
- 3 Call and mains indicator

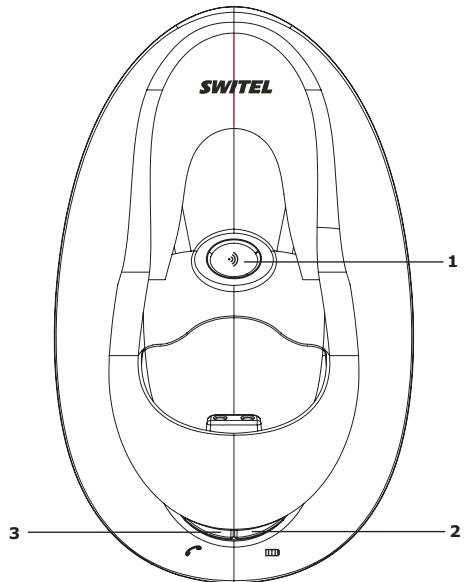

3 Setting up

3.1 Safety information

NOTE: Before setting up, it is essential that you read the Safety Information at the beginning of this operating manual.

3.2 Check contents of pack

The following items are supplied:

one base station	one mains cable
one handset	two standard batteries
one telephone connecting cable	one instruction manual

3.3 Connecting the base station

Position the telephone near to your telephone connection socket and to a mains socket.

1. Insert the plug of the power supply into the socket on the underside of the base station and plug the power supply into a properly installed 230 V mains socket. The plug-in power supply for the base station must always be connected. For safety reasons, use only the plug-in mains power supply provided.
2. Connect the telephone cable supplied to the telephone socket and the telephone jack on the underside of the base station. Use only the new telephone cable provided.
3. Run the two cables through the two cable channels to the rear of the base station.

3.4 Fitting standard batteries

To fit the standard rechargeable batteries supplied into the handset, press on the upper edge of the battery compartment and slide it downwards. Now insert the batteries taking care to ensure that the polarity is correct. Close the battery compartment cover.

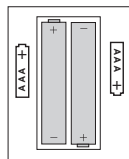

Important note: Place the handset in the **base station** with the display to the front **for at least 16 hours**. The telephone may malfunction if the batteries are not properly charged. The charging light  on the base station will come on.

3.5 Charging the standard batteries

The rechargeable batteries for your telephone have a stand-by time of max. 100 hours at room temperature and a maximum talk time of up to 10 hours. The current battery capacity is shown in the display.

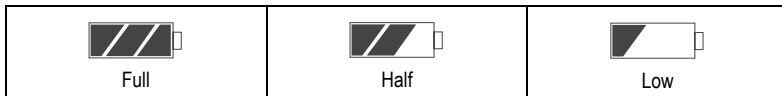

If the battery capacity is too low, the symbol will flash in the display and you will hear warning tones every 60 seconds.











To charge the batteries, place the handset in the base station with the display to the front.

Note: The batteries must be charged for at least 16 hours before being used for the first time. Exactly like your car battery, the rechargeable batteries are unavoidably subject to a certain ageing. However, you can have an influence on this ageing process by "training" the batteries to a certain extent. In regular use of the phone, if you cyclically charge and fully discharge the batteries by using the telephone until the  symbol appears in the display, a demand is placed on the batteries and they will repay you by giving maximum performance and a long life. Extended charging and extended discharging on the other hand will both degrade the capacity and shorten the life of the batteries.

4 Operation



4.1 The display

In the normal operating mode, the display shows the name of the handset. The pre-set name can be changed at any time. For more information, refer to 7.7. In addition, the main functions are shown in the display by means of various symbols.

	Lit: You are making a call.
EXT	Lit: You are making an external call. Flashing: You are receiving an external call.
INT	Lit: You are making an internal call. Flashing: You are receiving an internal call.
	Lit: You are in the caller list (CLID). Flashing: There are new calls stored in the caller list (CLID).
	Lit: This number in the caller list is a missing call.
	Lit: This number in the caller list was already taken.
	Flashing: Please charge the handset. Lit: Indication of battery capacity Cycling through of the segments: The handset is being charged.
	Lit: When the phone book is being used.
	Lit: Whenever programming is activated.
	Lit: The keypad lock is activated.
	Lit: The connection to the base station is satisfactory. Flashing: Base station out of range.
	Lit: The number is longer than 12 digits.

4.2 Receiving calls

When a call arrives, the ringing tone sounds on the handset and on the base station. The handset will ring a little later than the base station due to the radio transmission. The message **EXT.** will flash in the display. Press the call button  on the handset and the connection will be made. The call indicator on the base station will flash during the call.

Note: While the handset is ringing, you can adjust the ringer volume by means of the  and  buttons.

To end the call, replace the handset in the base station or press the call button  on the handset.





Notes: Please refer to Chapter 6 for information on how to show the caller's number in the display.

When the automatic call accept feature is selected, the call is automatically accepted as soon as you lift the handset from the base station. You can find out in Chapter 7.5.7.5 how to switch the automatic call accept feature on or off.

4.3 Making calls

1. Enter the required telephone number with a maximum of 32 digits using the number pad. As the display is only capable of showing 12 digits, in the case of longer phone numbers only the last 12 digits are displayed.





Note: If you have entered a number incorrectly, you can delete the number by repeatedly pressing the  button. The number is completely deleted by pressing the  button for a long time.

2. Press the call button  and the required connection will be made.

Note: You can also get a dialling tone by first pressing the call button . On entering the digits of your required phone number, your telephone will dial the number directly. With this method of making a call, it is not possible to correct individual digits in the number in the manner described above.

4.4 Dialling stored numbers from the phone book



After you have stored a few phone numbers, you can call these up very quickly and easily.



1. Press the phone book button . The display will now show the first number stored in alphabetical order.
2. You can now select all of the stored numbers with the  and  buttons. To choose a phone number directly alphabetically, press the appropriate letter.
3. Now press the call button  and the telephone number displayed will be automatically dialled.

4.5 Call duration display

The call duration in minutes and seconds is shown in the display during a call. Fifteen seconds after dialling, the display will switch from showing the number dialled to showing the duration of the call. The call duration will still be retained in the display for a few seconds after the call has been ended.

4.6 Switching the handset on and off

You can switch off the handset by pressing and holding the   button. If the handset is switched off, no battery power will be used. It will not be possible to receive calls.

Press the   button once to switch the handset on again. The display will show the message **BASE 1** and the handset will switch on again after a short time. The handset will switch itself on automatically as soon as you replace it on the base station.



4.7 Range information

The range of the handset is ca. 50 metres in closed rooms and ca. 300 metres outdoors. When there is a good contact with the base station, the  symbol will come on in the display.

If you are too far away from the base station, the  symbol will flash and you will hear warning tones. In this case, move nearer to the base station once more, as otherwise the call will be interrupted. These warning tones can be switched off as described in Chapter 7.8.



4.8 Muting the microphone in the handset

You can turn off the handset microphone during a call by using the  button. It is thus possible to speak without the other person hearing you. The loudspeaker in the handset remains switched on and you can continue to hear the other person.

1. Press the  button once during a call. The message **MUTE** will appear in the display.
2. To switch the microphone on again, press the  button once more. The **MUTE** message will go off and you can continue the call as normal.





4.9 Adjusting the receiver volume

If the receiver volume is too quiet or too loud for you, you can change this to suit your requirements.

You can adjust the volume during a call by means of the  and  buttons. The selected volume will be shown in the display with the message **EAR VOL 1 to 5**.

4.10 Redial facility





You can use the redial facility if the person called is engaged or does not reply. Your telephone remembers the last five numbers dialed.

1. Press the  button and the last phone number dialed will be shown in the display.
2. Further redial numbers can now be selected using the  button. The  button is used to page back through the list.
3. Now press the call button  and the telephone number displayed will be automatically dialed.

Note: If the redial number is stored in the phone book, the name will automatically appear in the display instead of the phone number.



Deleting redial numbers

To delete an individual number from the redial list, proceed as follows:

1. Press the  button and select the redial number that is to be deleted by means of the  and  buttons.
2. Press the  button and the display will show **DELETE?**.
3. Confirm with the menu button  and the telephone number will be deleted from the redial list.

Deleting all redial numbers

To delete all numbers from the redial list, proceed as follows:

1. Press the  button.
2. Hold the  button pressed until **DELETE ALL?** appears in the display.
3. Confirm with the menu button  and the telephone number will be deleted from the redial list.

4.11 Keypad lock

If you frequently carry the handset with you, you can lock the keypad so that buttons are not pressed unintentionally. Incoming calls can be received as normal when the keypad lock is switched on.

Activating the keypad lock



Press the  button on the handset for three seconds. The  symbol will appear in the display.

Deactivating the keypad lock



To deactivate the keypad lock, press the  button twice.

Note: The keypad lock can also be activated via the menu.

4.12 Temporary tone dialling

If you can only use your telephone in Pulse Dialling mode, you do not have to forego the facilities of Tone Dialling (e.g. interrogating an answering machine). You can change temporarily to Tone Dialling during a call by means of the   button. PULSE dialling will be reselected at the end of the call.

4.13 Paging from the base station to the handset

If you cannot remember where you have left the handset, press the  button on the base station. You will hear the handset audible signals for 30 seconds and thus be able to find it again easily. You can cancel the audible signals earlier by pressing any button on the handset or the  button on the base station.

4.14 Private exchanges

If you have connected your telephone to a private exchange, you can use all the facilities such as call transfer, automatic recall, etc. The "R" signal button gives you access to these facilities. The FLASH time "90ms" or 250ms will be required on a private exchange (Adjustment, see 7.11). You can find out from the dealer from whom the equipment was purchased whether your telephone will work on your private exchange without any problems.

4.15 Using Pause

With private exchanges, it is necessary to dial a certain number (e.g. "9" or "0") in order to obtain a dialling tone for an outside line on the extension. With some, older private exchanges, it takes some time before the dialling tone can be heard. Especially for these private exchanges, an automatic pause can be inserted after connecting to the outside line so that you can dial directly without waiting for the dialling tone.

Entering a pause when dialling manually









Press the redial button  once between the number for the outside line and the actual telephone number. After connecting to an outside line your telephone will wait for 3 seconds before dialling the actual telephone number.

The pause can also be saved with numbers in the phone book.

5 The phone book



30 numbers including a name can be stored in the phone book. The maximum length for a number is 20 characters.

5.1 Entering numbers in the phone book

1. Press the menu button . The display shows the message **PHONE BOOK**.
2. Press the  button again. The display shows the message **ADD ENTRY**.
3. Again confirm with the  button. The display shows the message **NAME?**.
4. Now enter the associated name (max. 12 letters) using the number pad. You will find information on how to enter names in the next section.
5. Confirm the name with the menu button . The display will show the message **NUMBER?**.
6. Enter the required telephone number using the number pad.
7. Again confirm with the  button. The display will show the message **MELODY 1 - 3**.
8. Now select which melody you wish to assign to this phone number using the selection buttons  and .
9. Again confirm with the  button. The display will again show the message **ADD ENTRY**.
10. If you want to enter more numbers, proceed as under Item 3. Exit the entry mode by holding the  button pressed.

Notes on the phone book:

- In addition, one of the three ring tones can be assigned to each phone number stored. In this way, you can tell who is calling you simply from the ring tone. This assignment will only work when your telephone line and also the caller has the CLID caller display facility.
- Always enter the dialling code for all phone numbers so that the telephone can also associate incoming local calls with a phone book entry.
- You will find further information on the caller display facility in Chapter 6.
- If the memory capacity of 30 numbers has been reached, the next time you try to store a number the display will show the message **MEMORY FULL**. In order to recreate more space, other numbers must be deleted first.



TIP! The phone book can also be viewed during a call. To do this, press the  button and select the entry in the usual way. The  menu button will show the stored number (press twice if there are more than 12 digits). If you press the  menu button again, you will return to the phone book.

How to enter names















The number keys are also printed with letters for entering names. By repeatedly pressing the appropriate button, upper case letters as well as numbers can be entered.

Example: You want to enter the name "Peter".











Press: 1 x button 7, 2 x button 3, 1 x button 8, 2 x button 3, 3 x button 7

- To enter a space, press the  button once.
- A hyphen can be entered by pressing the  button twice.
- To enter the same letter twice, press the appropriate letter and then wait until the cursor automatically jumps to the next position.
- Incorrect entries can be deleted with the  button.

5.2 Changing numbers stored in the phone book

1. Press the menu button . The display will show **PHONE BOOK**.
2. Press the  button again. The display will show **ADD ENTRY**.
3. Now press the  button. The display will show **MODIFY ENTRY**.
4. Again confirm with the  button. The display will now show the stored numbers in alphabetical order.
5. Now choose the number that you want to change using the  and  buttons.
6. Confirm the selection with the menu button . In turn, the display will show the name and the cursor will appear flashing after the last letter.
7. Now change the name using the number pad. You will find information on entering names in Chapter 5.1.
8. After you have completed the required changes, confirm again with the menu button . The display will now show the number.
9. Now change the number using the number pad. The individual digits of the phone number can be deleted by repeatedly pressing the  button.
10. After you have completed the required changes, confirm again with the menu button . The display will show the message **MELODY**.
11. Now select which melody you wish to assign to this phone number using the selection buttons  and .
12. After you have completed the required changes, confirm again with the menu button . The display will show the message **MODIFY ENTRY**.
13. If you want to change more numbers proceed as under Item 4. Exit the programming mode by holding the  button pressed.

5.3 Deleting stored numbers from the phone book

1. Press the menu button . The display will show **PHONE BOOK**.
2. Press the  button again. The display will show **ADD ENTRY**.
3. Now press the  button. The display will show **DELETE ENTRY**.
4. Confirm with the menu button .
5. Now choose the number that you want to delete using the  and  buttons.
6. After you have found the required number, confirm with the menu button  and the display will show the message **CONFIRM?**. The delete procedure is cancelled by holding the  button pressed.
7. Confirm again with the menu button  and the phone book entry will be deleted. The display again shows the message **DELETE ENTRY**.
8. When you have deleted the number, the message **DELETE ENTRY** will appear in the display. If you want to delete more numbers, proceed as under Item 4. Exit the delete mode by holding the  button pressed.

6 Caller display (CLID)

In Switzerland, this function is not offered by all network carriers.

In the case of incoming calls, you can see who is calling you by means of the caller display facility. If this function is available on your telephone, the display will show you the caller's telephone number when the telephone rings. If the caller has blocked the sending of his number or if the number cannot be displayed for technical reasons, the messages **WITHHELD** and **UNAVAILABLE** will appear in the display.

If you have stored this number in your phone book, the name will be displayed instead of the phone number. In addition, one of the three ring tones can be assigned to each phone number stored in the phone book so that you can tell who is calling you simply from the ring tone.



All calls are stored in a caller list so that you will not miss any calls even in your absence. A total of 30 phone numbers can be stored in the list. When the list is full, the oldest number is always deleted from the list. If new numbers are stored in the list during your absence, the  symbol will flash in the display.



Note: Caller display is an optional service from your telephone provider. Your telephone will show the number in the display if your telephone provider offers this service. The display of date and time is not transmitted by all telephone service providers. Please ask your telephone provider for further information. Furthermore, transmission of the phone number and also the date and time is not possible with many private exchanges.

6.1 The caller list

To view the phone numbers on the caller list, please proceed as follows:

1. Press the  button and the last phone number received will be shown in the display. If the caller list is empty, the display will show the message **EMPTY**.
2. Further numbers in the caller list can now be selected by means of the  and  buttons. If there are no more phone numbers available, you will hear a signal tone. Two symbols in the display will tell you whether the call was taken or not.





=> Missing call in your absence.



=> Received calls.

Notes: Information can be called up using the  button.











- If the phone number is longer than 12 digits, the remaining numbers will be displayed.
- Displays the number when the name of the caller is already stored in the phone book.
- Displays the date and time when this information is transmitted by the caller.
- If no further data are available, the display will show the message **ADD?**.
- You can return to the list once more by pressing the  button.

3. If you want to call back a number on the caller list directly, simply press the call button  and the number will be dialled immediately.

4. Exit the caller list by holding the  button pressed.







6.2 Storing telephone numbers from the Caller List in the phone book

A phone number stored in the caller list can be saved directly to the phone book.





1. Press the  button and the last phone number received will be shown in the display.
2. Now select the telephone number from the caller list that you want to put into the phone book by using the  and  buttons.
3. Press the  button until the message **ADD?** appears in the display.
4. Again confirm with the  button. The display will show the message **NAME?**.
5. Now enter the associated name (max. 12 letters) using the number pad.
6. Again confirm with the menu button  and the number will be shown in the display once more.
7. Again confirm with the  button. The display will show the message **MELODY 1 - 3**.
8. Now select which melody you wish to assign to this phone number using the selection buttons  and .
9. Again confirm with the menu button  and the number will be stored in the phone book.

Note: When the telephone number has been stored with a name in the phone book, the name that has been entered will appear in the caller list instead of the phone number.

6.3 Deleting individual telephone numbers from the caller list



1. Press the  button and the last phone number received will be shown in the display.
2. Now select the telephone number from the caller list that you want to delete by using the  and  buttons.
3. Press the  button. The display will show the message **DELETE?**.
4. Again confirm with the menu button  and the number will be deleted from the caller list or you can exit the Delete mode by pressing and holding the  button.

6.4 Deleting the entire Caller List

1. Press the  button and the last phone number received in the caller list will be shown in the display.
2. Hold the  button pressed until the message **DELETE ALL?** appears in the display.
3. Again confirm with the menu button  in order to delete the caller list or you can exit the Delete mode by pressing and holding the  button.



7 Special functions

All further programming functions can be accessed by means of a very user-friendly menu. Here are a few general instructions to help you find your way around the menu:

Programming is started by means of the  button. The  symbol comes on in the display during programming.

You can find the required level using the  and  buttons.

This level is opened using the  button.

In turn, you can find the required function using the  and  buttons and again confirm with the  button.

You can go back one level each time by pressing the  button.











Each save procedure will be cancelled automatically if no input is made within 15 seconds.

You can leave programming mode at any time without making any changes by pressing and holding the  button.

You will find a complete overview of the menu in Chapter 7.13.











7.1 Setting the ring tone on the handset (ring melodies)

Your handset can respond with three different ringing tones when a call comes through. If you are using the telephone system with several handsets, you can set different ring tones for external and internal calls.

1. Press the menu button .
2. Select the **HANDSET** menu with  and  and confirm with .
3. Select the function **EXT MELODY** (ring tone for external calls) or **INT MELODY** (ring tone for internal calls/with two handsets only) with the  and  buttons and confirm with .
4. Select the required melody with  and  and confirm with .
5. Now select further menu functions or exit the menu by pressing and holding the  button.











7.2 Ring tone volume on the handset

The volume of the ring tone on the handset can be adjusted in three steps. If at any time you do not want to be disturbed, you can also turn the ring tone off altogether. If the ring tone is turned off, incoming calls will only be signalled at the base station and by means of the display on the handset.

1. Press the menu button .
2. Select the **HANDSET** menu with  and  and confirm with .
3. Select the function **EXT RING VOL** (volume for external calls) or **INT RING VOL** (volume for internal calls/with two handsets only) with the  and  buttons and confirm with .
4. Select the required volume using  and  or switch the ring tone off with **VOLUME OFF** and confirm with .
5. Now select further menu functions or exit the menu by pressing and holding the  button.











7.3 Setting the ring tones on the base station (ring melodies)

The base station can also respond with three different ringing tones when a call comes through.

1. Press the menu button .
2. Select the **SETUP** menu with  and  and confirm with .
3. Select the **BASE MELODY** function with  and  and confirm with .
4. Select the required melody with  and  and confirm with .
5. Now select further menu functions or exit the menu by pressing and holding the  button.











7.4 Ring tone volume on the base station

The volume of the ring tone on the base station can be adjusted in three steps. If at any time you do not want to be disturbed, you can also turn the ring tone off altogether.

1. Press the menu button .
2. Select the **SETUP** menu with  and  and confirm with .
3. Select the **BASE VOLUME** function with  and  and confirm with .
4. Select the required volume using  and  or switch the ring tone off with **VOLUME OFF** and confirm with .
5. Now select further menu functions or exit the menu by pressing and holding the  button.











7.5 Accepting calls automatically

Incoming calls are accepted automatically when you lift the receiver from the base station. If you only want calls to be accepted by means of the  button, you can deactivate the automatic acceptance facility.

1. Press the menu button .
2. Select the **HANDSET** menu with  and  and confirm with .
3. Select the **AUTO ANSWER** function with  and  and confirm with .
4. Select **ON** or **OFF** with  and  and confirm with .
5. Now select further menu functions or exit the menu by pressing and holding the  button.











7.6 Tone (TD) or pulse (PD) dialling

This feature enables you to use your telephone both on analogue exchanges (PD) and on the new digital exchanges (TD). The factory setting is TONE dialling.

1. Press the menu button .
2. Select the **SETUP** menu with  and  and confirm with .
3. Select the **DIAL MODE** function with  and  and confirm with .
4. Select the required dialling mode with  and  and confirm with .
5. Now select further menu functions or exit the menu by pressing and holding the  button.

7.7 Changing display names

In normal operation, the message "D6025" appears in the display. If you have logged on several handsets to one base station, it can be useful to give each handset its own name. The number after the name shows with which number the handset can be called internally.

1. Press the menu button .
2. Select the **HANDSET** menu with  and  confirm with .
3. Select the **NAME** function with  and  and confirm with .
4. Now enter the required name using the number pad. Letters already entered can be deleted by repeatedly pressing the  button.
5. Confirm with .
6. Now select further menu functions or exit the menu by pressing and holding the  button.

7.8 Activating/Deactivating warning tones

Here, various warning tones can be activated or deactivated.

Button click















Each time a button is pressed, the handset confirms with a button click. The button click can be switched on or off.

Warning tone for low battery

If the battery capacity is too low, a warning tone will remind you that you must charge the handset.











Range warning

If you are too far away from the base station, a warning tone will remind you that you are losing contact with the base station.

1. Press the menu button .
2. Select the **HANDSET** menu with  and  and confirm with .
3. Select the **BEEP** function with  and  and confirm with .
4. Select one of the functions **KEYTONE**, **LOW BATTERY** or **OUT RANGE** with  and  and confirm with .
5. Switch the selected warning tone on or off with  and  and confirm with .
6. Now select further menu functions or exit the menu by pressing and holding the  button.

7.9 Changing the PIN code











Some functions of the telephone system are protected against unauthorised use by a PIN code. The PIN code consists of four numbers. As supplied, the PIN code is set to "0000". To change the PIN code, proceed as follows:

1. Press the menu button .
2. Select the **SETUP** menu with  and  and confirm with .
3. Select the **PIN CODE** function with  and  and confirm with .
4. Now enter the current four-digit PIN code using the number pad (factory setting 0 0 0 0) and confirm with .
5. Now enter the new four-digit PIN code using the number pad and confirm with .
6. Now enter the new four-digit PIN code once more for confirmation and confirm with .
7. Now select further menu functions or exit the menu by pressing and holding the  button.











If the old PIN code is not entered correctly, the process will be aborted.

7.10 Setting the display language

The display messages can be set up in German, Italian, Spain, Netherlands, English, French and Danish/Norwegian/Swedish.

1. Press the menu button .
2. Select the **HANDSET** menu with  and  and confirm with .
3. Select the **LANGUAGE** function with  and  and confirm with .
4. Select a language with  and  and confirm with .
5. Exit the entry mode by holding the  button pressed.

7.11 Setting the FLASH time









1. Press the menu button .
2. Select the **SETUP** menu with  and  and confirm with .
3. Select the **RECALL** function with  and  and confirm with .
4. Select the flash time **FLASH 1** (90ms) or **FLASH 2** (250ms) with  and  and confirm with .
5. Exit the entry mode by holding the  button pressed.

7.12 Restoring factory settings





The handset and the base station are reset to the factory settings using this function. The phone book, the caller list (CLID) and all phone numbers in the redial facility will be deleted.

Factory settings:

Language: German	Handset name: D6025
Battery warning tone: On	Automatic call accept: On
Range warning: On	External ring tone: 3
Button click: On	Internal ring tone: 1
Receiver volume: 3	Handset ring tone volume: 3
Pin code: 0 0 0 0	Base ring tone: 2
Pause: 3 sec.	Base ring tone volume: 3
Dialling method: MV/Tone	FLASH time: 90ms

1. Press the menu button .
2. Select the **SETUP** menu with  and  and confirm with .
3. Select the **DEFAULT** function with  and  and confirm with .
4. Enter the PIN code using the number pad (factory setting 0000) and confirm with . The message **CONFIRM?** will appear in the display.
5. Confirm with the menu button .
6. After a short time, the factory settings will be restored. The display will indicate the ready mode once more.

Note: If you have forgotten the PIN code, you can also restore the factory settings without it.

1. Remove a battery from the handset.
2. Hold the  button pressed and replace the battery. Hold the  button pressed until the message **DEFAULT** appears in the display.
3. Confirm with  and the factory settings will be restored. You can abort the process by pressing the  button.

- Special functions -

7.13 Menu structure

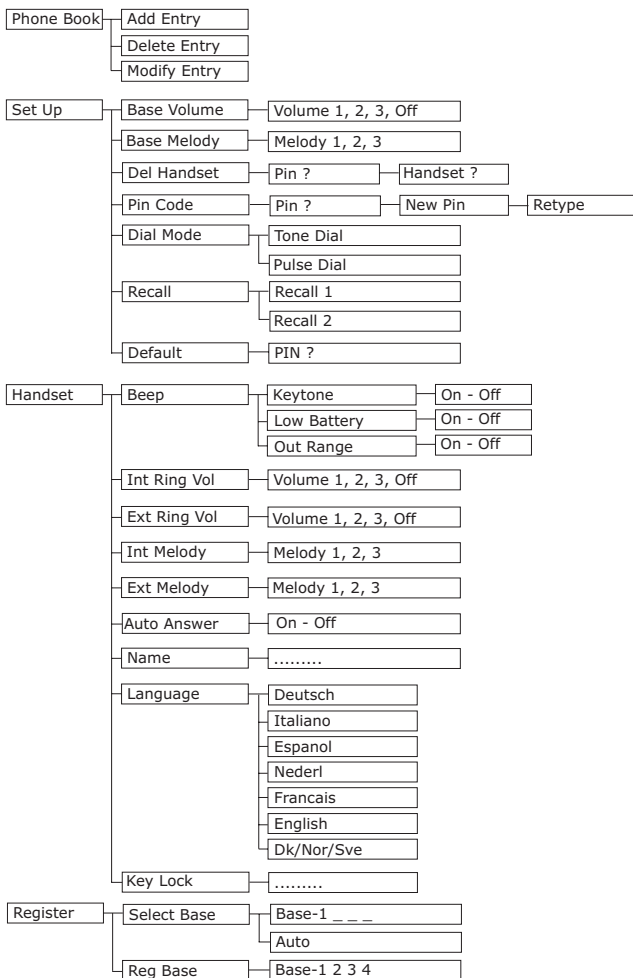

8 Multiple handsets

One additional handset can be logged onto your base station.

Note: SWITEL handsets and also handsets from other manufacturers can be integrated into the telephone system by means of the internationally adopted GAP standard. In the same way, you can use an SWITEL handset with base stations from other manufacturers, as long as these units work using the GAP standard.



When you use multiple handsets you will have the following options:

- Internal calls between handsets.
- External calls can be forwarded between handsets.
- Incoming external calls are signalled on all handsets.

Warning: If another handset is already using the external line, the indicator light will illuminate on all handsets. In this case, it is not possible to make a further external call.

8.1 Making an internal call

When you have connected multiple handsets to a base station, you will be able to make internal calls.

To do this, press the  button and then the number 1 or 2 of the required handset. The call is accepted with the call button  on the handset called.

8.2 Connecting external calls to another handset

If you have accepted an external call on one handset, you can forward the external call to another handset. To do this, press the  button and then the number (1 or 2) of the required handset.

If there should be no reply from the handset called, you can take the call back with the  button.











After the internal call has been accepted at the other handset, you have the following options:

A. Consultation / Brokering: You can now speak to the internal subscriber and return to the external caller by pressing the  button. You can switch between the external and the internal call as many times as you like in this way.

B. Forward the call: The external call is forwarded to the handset called by pressing the call button  on the first handset.

8.3 Logging on and logging off handsets

8.3.1 Logging on handsets

1. Press and hold the page button  on the base station for 6 seconds until you hear two signal tones. Now log on the new handset to the base station within 90 seconds.
2. Press the  button on the handset.
3. Select the **REGISTER** menu with  and  and confirm with .
4. Select the **REG BASE** menu with  and  and confirm with .
5. Now enter the number of the base station (1 - 4) using the number pad. If the handset is already connected to a base station, the corresponding numbers will flash.
6. Confirm your entry with the  button. A search will now be carried out for the base station.
7. After the base station has been found, you must enter the PIN Code for the base station (factory setting 0 0 0 0).
8. Confirm your entry with the  button and after a few seconds you will hear a signal tone. The handset is now logged on and can be used for external and internal calls.
9. An internal number will now be automatically assigned to the handset. The handset that has already been logged on has the internal number 1. The second handset to be logged on is given the internal number 2. These internal numbers are shown in the right of the display next to the name.











- Multiple handsets -

8.3.2 Logging on other DECT-GAP telephones to the base station

In order to log on a DECT-GAP handset, follow the instructions in the other supplier's operating manual and then press the  button on the base station for 6 seconds. Use the PIN-Code 0 0 0 0 to log on.

8.3.3 Logging off handsets

A handset can only be logged off using another handset that is still logged-on. It is therefore not possible to carry out the logging-off procedure using the handset that is to be logged off.











1. Press the  button on the handset.
2. Select the **SETUP** menu with  and  and confirm with .
3. Select the **DEL HANDSET** function with  and  and confirm with .
4. Now enter the PIN code of the base station (factory setting 0 0 0 0) and confirm with the  button.
5. Now select the number 1 or 2 of the handset to be logged off and confirm with the  button. You can abort the process by pressing the  button. If the logging-off is successful, after a few seconds you will hear a signal tone. The handset is now logged off and can no longer be used for external and internal calls.

8.4 Additional base stations

You can increase the range of the handsets by using several base stations. In order to make use of this effect, all base stations must be connected to a telephone socket. Depending upon the application, you can allocate the same telephone number to each base station or you can give the base stations different numbers. Make sure that the ranges of all base stations overlap. Each handset must be logging on to each basis station. Please test the range of the handsets before putting a new base station into operation.

If a handset is logged on to the base station and if the automatic base station selection is activated (further information in this chapter), the handset is always forwarded automatically to the nearest base station. **Current calls cannot** be transferred from one base station to another.

Selecting a base station

1. Press the  button on the handset.
2. Select the **REGISTER** menu with  and  and confirm with .
3. Select the **SELECT BASE** menu with  and  and confirm with .
4. The display will now show all base stations that the handset is already logged on to. The number of the currently active base station will flash. Select the required base station to which the handset is to be switched by means of the number pad.
Or change to the **AUTO** setting with the  and  buttons. With this setting, the handset changes automatically to the nearest base station when the connection to the current base station becomes too weak.
5. Confirm with the  button.

9 Troubleshooting

If you have problems with your telephone, please check the following points first. For any claims under the warranty, please refer to your dealer. The warranty period is 2 years. The rechargeable batteries are covered by a 12 months warranty.

No calls possible	The telephone line is not correctly connected or is faulty. Use only the telephone cable provided. Test whether your telephone connection is in order by using another telephone. The power supply is not plugged in or there is a total power failure. The rechargeable batteries are flat or defective. You are too far away from the base station.
Connection is cut off or drops out	You are too far away from the base station. Incorrect position for the base station.
Dialling not possible	Dialling mode incorrectly set (see Chapter 7.6).
The system no longer responds or is in an undefined state.	Reset all functions to the factory settings. Before doing so, briefly remove the power supply from the socket. Factory settings see Chapter 7.12.
The charging light does not come on.	Place the handset properly on the base station, clean the contact surfaces on the handset and on the base station with a soft, dry cloth.
The battery symbol flashes in the display after a few hours.	Place the handset on the base station for 16 hours. If this does not help, replace the rechargeable batteries.
Display dark	Caused by direct sunlight, allow the handset to cool down.

10 Technical data

Standard	DECT-GAP
Channel number	1880 to 1990 MHz
Power supply	Base station 220/230V, 50 Hz
Range	Indoors up to 50 m
Range	Outdoors up to 300 m
Standby	up to 100 hours
Max. call duration	up to 10 hours
Rechargeable batteries	2 x 1.2V/550mAh, Type AAA
Dialling method	TD or PD
Permissible ambient temperature	10°C to 30°C
Permissible relative humidity	20 to 75%
Signal button function	90ms or 250ms

- Declaration of Conformity -

WE TELGO AG
Of Route d'Englisberg 11, CH-1763 Granges Paccot

Declare under our sole responsibility that the product

Model: D6025
Description: CORDLESS DECT TELEPHONE

Is in conformity with directives:
R&TTE Directive (1999/5/EC)

Compliance is achieved by conformity to the following:

Test Standards: EN301 406, EN301 489-1/6, EN60950

Test Report No : ET92B-07-083, ET93B-01-030, ET92B-07-83-1,
ET93S-01-103-02, ET93S-01-103-02

Authorised signatory:

Signature:

Name:

Position in the company:

Date of issue:

Selim Dusi
Managing Director
06.08.2004

Copies of this document will be held on file for a period of 10 years after the last production.



Supplier: TELGO AG, Route d'Englisberg 11, CH-1763 Granges Paccot
Product: SWITEL D6025

This product is intended for connection to analogue PSTN lines within Switzerland.

However, due to differences between the individual PSTNs provided in the different countries, the approval does not, of itself, give an unconditional assurance of successful operation on every PSTN network termination point.

ADDITIONAL INFORMATION

In the event of a mains power failure it will not be possible to dial emergency services numbers.

SWITEL

www.switel.com