

Robert Bosch GmbH

Geschäftsbereich Elektrowerkzeuge
D-70745 Leinfelden-Echterdingen
Germany

www.bosch-pt.com

2 609 002 813 (2008.10) O / 260 WEU

PSR 7,2 LI



BOSCH

de Originalbetriebs-
anleitung
en Original instructions
fr Notice originale
es Manual original
pt Manual original
it Istruzioni originali
nl Oorspronkelijke
gebruiksaanwijzing
da Original
brugsanvisning
sv Bruksanvisning i
original

no Original driftsinstruks
fi Alkuperäiset ohjeet
el Πρωτότυπο οδηγιών
χρήσης
tr Orijinal işletme
talimatı





2 |



Deutsch	Seite	5
English	Page	26
Français	Page	45
Español	Página	66
Português	Página	87
Italiano	Pagina	107
Nederlands	Pagina	129
Dansk	Side	149
Svenska	Sida	167
Norsk	Side	185
Suomi	Sivu	203
Ελληνικά	Σελίδα	221
Türkçe	Sayfa	242

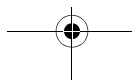
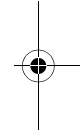
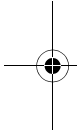

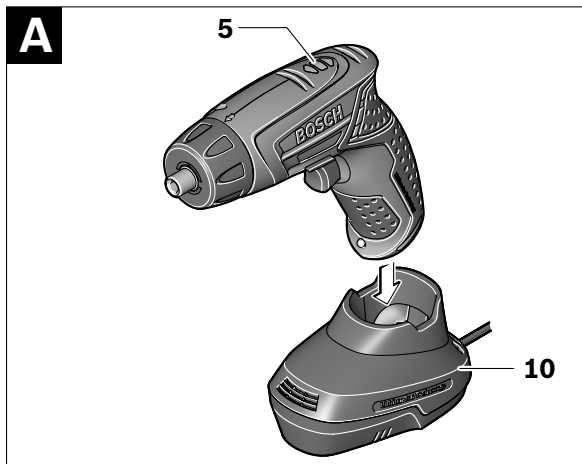
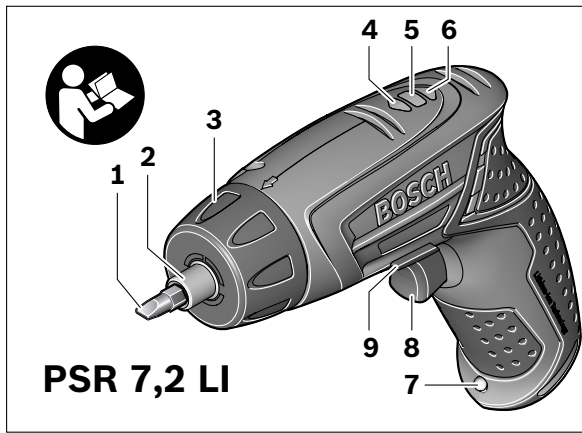

4 |

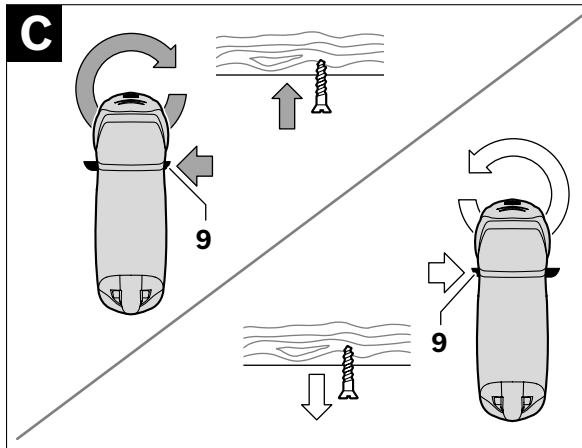
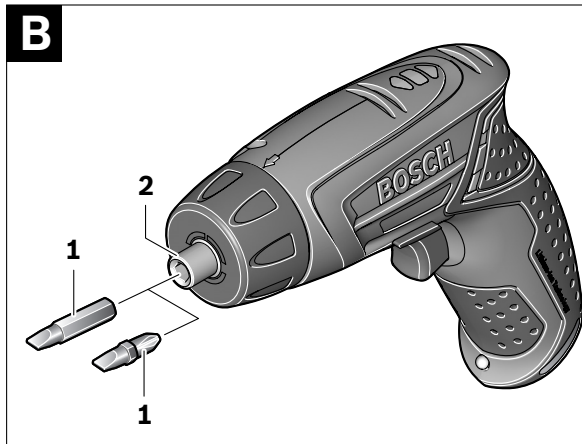

Sicherheitshinweise

Allgemeine Sicherheitshinweise für Elektrowerkzeuge

⚠ WARNUNG Lesen Sie alle Sicherheitshinweise und Anweisungen. Versäumnisse bei der Einhaltung der Sicherheitshinweise und Anweisungen können elektrischen Schlag, Brand und/oder schwere Verletzungen verursachen.

Bewahren Sie alle Sicherheitshinweise und Anweisungen für die Zukunft auf.

Der in den Sicherheitshinweisen verwendete Begriff „Elektrowerkzeug“ bezieht sich auf netzbetriebene Elektrowerkzeuge (mit Netzkabel) und auf akkubetriebene Elektrowerkzeuge (ohne Netzkabel).

1) Arbeitsplatzsicherheit

- a) **Halten Sie Ihren Arbeitsbereich sauber und gut beleuchtet.** Unordnung oder unbeleuchtete Arbeitsbereiche können zu Unfällen führen.
- b) **Arbeiten Sie mit dem Elektrowerkzeug nicht in explosionsgefährdeter Umgebung, in der sich brennbare Flüssigkeiten, Gase oder Stäube befinden.** Elektrowerkzeuge erzeugen Funken, die den Staub oder die Dämpfe entzünden können.
- c) **Halten Sie Kinder und andere Personen während der Benutzung des Elektrowerkzeugs fern.** Bei Ablenkung können Sie die Kontrolle über das Gerät verlieren.

6 | Deutsch**2) Elektrische Sicherheit**

- a) Der Anschlussstecker des Elektrowerkzeuges muss in die Steckdose passen. Der Stecker darf in keiner Weise verändert werden. Verwenden Sie keine Adapterstecker gemeinsam mit schutzgeerdeten Elektrowerkzeugen.** Unveränderte Stecker und passende Steckdosen verringern das Risiko eines elektrischen Schlages.
- b) Vermeiden Sie Körperkontakt mit geerdeten Oberflächen wie von Rohren, Heizungen, Herden und Kühlschränken.** Es besteht ein erhöhtes Risiko durch elektrischen Schlag, wenn Ihr Körper geerdet ist.
- c) Halten Sie Elektrowerkzeuge von Regen oder Nässe fern.** Das Eindringen von Wasser in ein Elektrowerkzeug erhöht das Risiko eines elektrischen Schlages.
- d) Zweckentfremden Sie das Kabel nicht, um das Elektrowerkzeug zu tragen, aufzuhängen oder um den Stecker aus der Steckdose zu ziehen. Halten Sie das Kabel fern von Hitze, Öl, scharfen Kanten oder sich bewegendem Geräteteilen.** Beschädigte oder verwickelte Kabel erhöhen das Risiko eines elektrischen Schlages.
- e) Wenn Sie mit einem Elektrowerkzeug im Freien arbeiten, verwenden Sie nur Verlängerungskabel, die auch für den Außenbereich geeignet sind.** Die Anwendung eines für den Außenbereich geeigneten Verlängerungskabels verringert das Risiko eines elektrischen Schlages.

f) Wenn der Betrieb des Elektrowerkzeuges in feuchter Umgebung nicht vermeidbar ist, verwenden Sie einen Fehlerstromschutzschalter. Der Einsatz eines Fehlerstromschutzschalters vermindert das Risiko eines elektrischen Schlages.

3) Sicherheit von Personen

a) Seien Sie aufmerksam, achten Sie darauf, was Sie tun, und gehen Sie mit Vernunft an die Arbeit mit einem Elektrowerkzeug. Benutzen Sie kein Elektrowerkzeug, wenn Sie müde sind oder unter dem Einfluss von Drogen, Alkohol oder Medikamenten stehen. Ein Moment der Unachtsamkeit beim Gebrauch des Elektrowerkzeuges kann zu ernsthaften Verletzungen führen.

b) Tragen Sie persönliche Schutzausrüstung und immer eine Schutzbrille. Das Tragen persönlicher Schutzausrüstung, wie Staubmaske, rutschfeste Sicherheitsschuhe, Schutzhelm oder Gehörschutz, je nach Art und Einsatz des Elektrowerkzeuges, verringert das Risiko von Verletzungen.

c) Vermeiden Sie eine unbeabsichtigte Inbetriebnahme. Vergewissern Sie sich, dass das Elektrowerkzeug ausgeschaltet ist, bevor Sie es an die Stromversorgung und/oder den Akku anschließen, es aufnehmen oder tragen. Wenn Sie beim Tragen des Elektrowerkzeuges den Finger am Schalter haben oder das Gerät eingeschaltet an die Stromversorgung anschließen, kann dies zu Unfällen führen.

8 | Deutsch

d) Entfernen Sie Einstellwerkzeuge oder Schraubenschlüssel, bevor Sie das Elektrowerkzeug einschalten. Ein Werkzeug oder Schlüssel, der sich in einem drehenden Geräteteil befindet, kann zu Verletzungen führen.

e) Vermeiden Sie eine abnormale Körperhaltung. Sorgen Sie für einen sicheren Stand und halten Sie jederzeit das Gleichgewicht. Dadurch können Sie das Elektrowerkzeug in unerwarteten Situationen besser kontrollieren.

f) Tragen Sie geeignete Kleidung. Tragen Sie keine weite Kleidung oder Schmuck. Halten Sie Haare, Kleidung und Handschuhe fern von sich bewegenden Teilen. Lockere Kleidung, Schmuck oder lange Haare können von sich bewegenden Teilen erfasst werden.

g) Wenn Staubabsaug- und -auffangeinrichtungen montiert werden können, vergewissern Sie sich, dass diese angeschlossen sind und richtig verwendet werden. Verwendung einer Staubabsaugung kann Gefährdungen durch Staub verringern.

4) Verwendung und Behandlung des Elektrowerkzeuges

a) Überlasten Sie das Gerät nicht. Verwenden Sie für Ihre Arbeit das dafür bestimmte Elektrowerkzeug. Mit dem passenden Elektrowerkzeug arbeiten Sie besser und sicherer im angegebenen Leistungsbereich.

b) Benutzen Sie kein Elektrowerkzeug, dessen Schalter defekt ist. Ein Elektrowerkzeug, das sich nicht mehr ein- oder ausschalten lässt, ist gefährlich und muss repariert werden.

- c) Ziehen Sie den Stecker aus der Steckdose und/oder entfernen Sie den Akku, bevor Sie Geräteeinstellungen vornehmen, Zubehörteile wechseln oder das Gerät welegen.** Diese Vorsichtsmaßnahme verhindert den unbeabsichtigten Start des Elektrowerkzeuges.
- d) Bewahren Sie unbenutzte Elektrowerkzeuge außerhalb der Reichweite von Kindern auf. Lassen Sie Personen das Gerät nicht benutzen, die mit diesem nicht vertraut sind oder diese Anweisungen nicht gelesen haben.** Elektrowerkzeuge sind gefährlich, wenn sie von unerfahrenen Personen benutzt werden.
- e) Pflegen Sie Elektrowerkzeuge mit Sorgfalt. Kontrollieren Sie, ob bewegliche Teile einwandfrei funktionieren und nicht klemmen, ob Teile gebrochen oder so beschädigt sind, dass die Funktion des Elektrowerkzeuges beeinträchtigt ist. Lassen Sie beschädigte Teile vor dem Einsatz des Gerätes reparieren.** Viele Unfälle haben ihre Ursache in schlecht gewarteten Elektrowerkzeugen.
- f) Halten Sie Schneidwerkzeuge scharf und sauber.** Sorgfältig gepflegte Schneidwerkzeuge mit scharfen Schneidkanten verklemmen sich weniger und sind leichter zu führen.
- g) Verwenden Sie Elektrowerkzeug, Zubehör, Einsatzwerkzeuge usw. entsprechend diesen Anweisungen. Berücksichtigen Sie dabei die Arbeitsbedingungen und die auszuführende Tätigkeit.** Der Gebrauch von Elektrowerkzeugen für andere als die vorgesehenen Anwendungen kann zu gefährlichen Situationen führen.

10 | Deutsch**5) Verwendung und Behandlung des Akkuwerkzeuges**

- a) Laden Sie die Akkus nur in Ladegeräten auf, die vom Hersteller empfohlen werden.** Für ein Ladegerät, das für eine bestimmte Art von Akkus geeignet ist, besteht Brandgefahr, wenn es mit anderen Akkus verwendet wird.
- b) Verwenden Sie nur die dafür vorgesehenen Akkus in den Elektrowerkzeugen.** Der Gebrauch von anderen Akkus kann zu Verletzungen und Brandgefahr führen.
- c) Halten Sie den nicht benutzten Akku fern von Büroklammern, Münzen, Schlüsseln, Nägeln, Schrauben oder anderen kleinen Metallgegenständen, die eine Überbrückung der Kontakte verursachen könnten.** Ein Kurzschluss zwischen den Akkukontakten kann Verbrennungen oder Feuer zur Folge haben.
- d) Bei falscher Anwendung kann Flüssigkeit aus dem Akku austreten. Vermeiden Sie den Kontakt damit. Bei zufälligem Kontakt mit Wasser abspülen. Wenn die Flüssigkeit in die Augen kommt, nehmen Sie zusätzlich ärztliche Hilfe in Anspruch.** Austretende Akkuflüssigkeit kann zu Hautreizungen oder Verbrennungen führen.

6) Service

- a) Lassen Sie Ihr Elektrowerkzeug nur von qualifiziertem Fachpersonal und nur mit Original-Ersatzteilen reparieren.** Damit wird sichergestellt, dass die Sicherheit des Elektrowerkzeuges erhalten bleibt.

Sicherheitshinweise für Schrauber

- ▶ **Halten Sie das Gerät an den isolierten Griffflächen, wenn Sie Arbeiten ausführen, bei denen die Schraube verborgene Stromleitungen treffen kann.** Der Kontakt der Schraube mit einer spannungsführenden Leitung kann auch metallene Geräteteile unter Spannung setzen und zu einem elektrischen Schlag führen.
- ▶ **Halten Sie das Elektrowerkzeug gut fest.** Beim Festziehen und Lösen von Schrauben können kurzfristig hohe Reaktionsmomente auftreten.
- ▶ **Sichern Sie das Werkstück.** Ein mit Spannvorrichtungen oder Schraubstock festgehaltenes Werkstück ist sicherer gehalten als mit Ihrer Hand.
- ▶ **Bringen Sie vor allen Arbeiten am Elektrowerkzeug (z. B. Wartung, Werkzeugwechsel etc.) sowie bei dessen Transport und Aufbewahrung den Drehrichtungsumschalter in Mittelstellung.** Bei unbeabsichtigtem Betätigen des Ein-/Ausschalters besteht Verletzungsgefahr.
- ▶ **Vermeiden Sie ein versehentliches Einschalten. Vergewissern Sie sich, dass der Ein-/Ausschalter in ausgeschalteter Position ist, bevor Sie einen Akku einsetzen.** Das Tragen des Elektrowerkzeugs mit Ihrem Finger am Ein-/Ausschalter oder das Einsetzen des Akkus in das eingeschaltete Elektrowerkzeug kann zu Unfällen führen.
- ▶ **Öffnen Sie den Akku nicht.** Es besteht die Gefahr eines Kurzschlusses.



Schützen Sie das Elektrowerkzeug vor Hitze, z. B. auch vor dauernder Sonneneinstrahlung, und Feuer. Es besteht Explosionsgefahr.

12 | Deutsch

- ▶ **Bei Beschädigung und unsachgemäßem Gebrauch des Akkus können Dämpfe austreten. Führen Sie Frischluft zu und suchen Sie bei Beschwerden einen Arzt auf.** Die Dämpfe können die Atemwege reizen.
- ▶ **Bei defektem Akku kann Flüssigkeit austreten und angrenzende Gegenstände benetzen. Überprüfen Sie betroffene Teile.** Reinigen Sie diese oder tauschen Sie sie gegebenenfalls aus.

Sicherheitshinweise für Ladegeräte

-  **Halten Sie das Ladegerät von Regen oder Nässe fern.** Das Eindringen von Wasser in ein Ladegerät erhöht das Risiko eines elektrischen Schlages.
- ▶ **Laden Sie keine Fremd-Akkus.** Das Ladegerät ist nur zum Laden von Bosch Li-Ionen-Akkus mit den in den Technischen Daten angegebenen Spannungen geeignet. Ansonsten besteht Brand- und Explosionsgefahr.
- ▶ **Halten Sie das Ladegerät sauber.** Durch Verschmutzung besteht die Gefahr eines elektrischen Schlages.
- ▶ **Überprüfen Sie vor jeder Benutzung Ladegerät, Kabel und Stecker. Benutzen Sie das Ladegerät nicht, sofern Sie Schäden feststellen. Öffnen Sie das Ladegerät nicht selbst und lassen Sie es nur von qualifiziertem Fachpersonal und nur mit Original-Ersatzteilen reparieren.** Beschädigte Ladegeräte, Kabel und Stecker erhöhen das Risiko eines elektrischen Schlages.
- ▶ **Betreiben Sie das Ladegerät nicht auf leicht brennbarem Untergrund (z. B. Papier, Textilien etc.) bzw. in brennbarer Umgebung.** Wegen der beim Laden auftretenden Erwärmung des Ladegerätes besteht Brandgefahr.

Funktionsbeschreibung



Lesen Sie alle Sicherheitshinweise und Anweisungen. Versäumnisse bei der Einhaltung der Sicherheitshinweise und Anweisungen können elektrischen Schlag, Brand und/oder schwere Verletzungen verursachen.

Bestimmungsgemäßer Gebrauch

Das Elektrowerkzeug ist bestimmt zum Eindrehen und Lösen von Schrauben.

Benutzen Sie das Elektrowerkzeug nur, wenn Sie alle Funktionen voll einschätzen und ohne Einschränkungen durchführen können oder entsprechende Anweisungen erhalten haben.

Abgebildete Komponenten

Die Nummerierung der abgebildeten Komponenten bezieht sich auf die Darstellung des Elektrowerkzeuges auf der Grafikkarte.

- 1 Schrauberbit*
- 2 Werkzeugaufnahme
- 3 Einstellring Drehmomentvorwahl
- 4 Drehrichtungsanzeige Rechtslauf
- 5 Akku-Ladezustandsanzeige
- 6 Drehrichtungsanzeige Linkslauf
- 7 Lampe „Power Light“
- 8 Ein-/Ausschalter
- 9 Drehrichtungsumschalter
- 10 Ladegerät

***Abgebildetes oder beschriebenes Zubehör gehört nicht zum Standard-Lieferumfang. Das vollständige Zubehör finden Sie in unserem Zubehörprogramm.**

14 | Deutsch

Technische Daten

Akku-Schrauber		PSR 7,2 LI
Sachnummer		3 603 J57 7..
Nennspannung	V=	7,2
Leerlaufdrehzahl	min ⁻¹	0–230
max. Drehmoment harter/weicher Schraubfall nach ISO 5393	Nm	10/6
max. Schrauben-Ø	mm	6
Gewicht entsprechend EPTA-Procedure 01/2003	kg	0,5
Akku		Li-Ionen
Kapazität	Ah	1,3
Anzahl der Akkuzellen		2
Ladegerät		
Sachnummer		2 607 225 553 (EU) 2 607 225 555 (UK)
Ladezeit	h	5,0

Bitte beachten Sie die Sachnummer auf dem Typenschild Ihres Elektrowerkzeugs. Die Handelsbezeichnungen einzelner Elektrowerkzeuge können variieren.



Geräusch-/Vibrationsinformation

Messwerte ermittelt entsprechend EN 60745.

Der A-bewertete Schalldruckpegel des Elektrowerkzeugs ist typischerweise kleiner als 70 dB(A). Unsicherheit K = 3 dB.

Der Geräuschpegel beim Arbeiten kann 80 dB(A) überschreiten.

Gehörschutz tragen!

Schwingungsgesamtwerte (Vektorsumme dreier Richtungen) ermittelt entsprechend EN 60745:

Schrauben: Schwingungsemissionswert $a_h < 2,5 \text{ m/s}^2$, Unsicherheit K = $1,5 \text{ m/s}^2$.

Der in diesen Anweisungen angegebene Schwingungspegel ist entsprechend einem in EN 60745 genormten Messverfahren gemessen worden und kann für den Vergleich von Elektrowerkzeugen miteinander verwendet werden. Er eignet sich auch für eine vorläufige Einschätzung der Schwingungsbelastung.

Der angegebene Schwingungspegel repräsentiert die hauptsächlichsten Anwendungen des Elektrowerkzeugs. Wenn allerdings das Elektrowerkzeug für andere Anwendungen, mit abweichenden Einsatzwerkzeugen oder ungenügender Wartung eingesetzt wird, kann der Schwingungspegel abweichen. Dies kann die Schwingungsbelastung über den gesamten Arbeitszeitraum deutlich erhöhen.

Für eine genaue Abschätzung der Schwingungsbelastung sollten auch die Zeiten berücksichtigt werden, in denen das Gerät abgeschaltet ist oder zwar läuft, aber nicht tatsächlich im Einsatz ist. Dies kann die Schwingungsbelastung über den gesamten Arbeitszeitraum deutlich reduzieren.

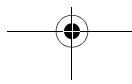
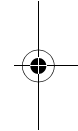
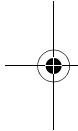



16 | Deutsch



Legen Sie zusätzliche Sicherheitsmaßnahmen zum Schutz des Bedieners vor der Wirkung von Schwingungen fest wie zum Beispiel: Wartung von Elektrowerkzeug und Einsatzwerkzeugen, Warmhalten der Hände, Organisation der Arbeitsabläufe.

Konformitätserklärung 

Wir erklären in alleiniger Verantwortung, dass das unter „Technische Daten“ beschriebene Produkt mit den folgenden Normen oder normativen Dokumenten übereinstimmt: EN 60745 (Akku-Gerät) und EN 60335 (Akku-Ladegerät) gemäß den Bestimmungen der Richtlinien 2006/95/EG, 2004/108/EG, 98/37/EG (bis 28.12.2009), 2006/42/EG (ab 29.12.2009).

Technische Unterlagen bei:
Robert Bosch GmbH, PT/ESC,
D-70745 Leinfelden-Echterdingen

 08

Dr. Egbert Schneider	Dr. Eckerhard Strötgen
Senior Vice President	Head of Product
Engineering	Certification

ppa. [Signature] i.v. [Signature]

Robert Bosch GmbH, Power Tools Division
D-70745 Leinfelden-Echterdingen
16.09.2008

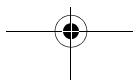

Montage

Akku laden (siehe Bild A)

- ▶ **Benutzen Sie kein anderes Ladegerät.** Das mitgelieferte Ladegerät ist auf den in Ihr Elektrowerkzeug eingebauten Li-Ionen-Akku abgestimmt.
- ▶ **Beachten Sie die Netzspannung!** Die Spannung der Stromquelle muss mit den Angaben auf dem Typenschild des Ladegerätes übereinstimmen. Mit 230 V gekennzeichnete Ladegeräte können auch an 220 V betrieben werden.

Hinweis: Der Akku wird teilgeladen ausgeliefert. Um die volle Leistung des Akkus zu gewährleisten, laden Sie vor dem ersten Einsatz den Akku vollständig im Ladegerät auf.

Der Li-Ionen-Akku kann jederzeit aufgeladen werden, ohne die Lebensdauer zu verkürzen. Eine Unterbrechung des Ladevorganges schädigt den Akku nicht.

Der Li-Ionen-Akku ist durch die „Electronic Cell Protection (ECP)“ gegen Tiefentladung geschützt. Bei entladem Akku wird das Elektrowerkzeug durch eine Schutzschaltung abgeschaltet: Das Einsatzwerkzeug bewegt sich nicht mehr.

⚠ ACHTUNG Drücken Sie nach dem automatischen Abschalten des Elektrowerkzeuges **nicht weiter auf den Ein-/Ausschalter**. Der Akku kann beschädigt werden.

Der Ladevorgang beginnt, sobald der Netzstecker des Ladegerätes in die Steckdose gesteckt und der Akku-Schrauber anschließend auf das Ladegerät **10** aufgelegt wird.

18 | Deutsch

Die Akku-Ladezustandsanzeige **5** zeigt den Ladefortschritt an. Beim Ladevorgang **blinkt** die Anzeige grün. Der Akku ist vollständig geladen, wenn die Anzeige **dauerhaft** grün leuchtet.

Beim Ladevorgang erwärmt sich der Handgriff des Elektrowerkzeuges. Dies ist normal.

Bei längerem Nichtgebrauch trennen Sie das Ladegerät bitte vom Stromnetz.

Das Elektrowerkzeug kann während des Ladevorgangs nicht benutzt werden; es ist nicht defekt, wenn es während des Ladevorgangs nicht funktioniert.

Beachten Sie die Hinweise zur Entsorgung.

Werkzeugwechsel (siehe Bild B)

- ▶ **Bringen Sie vor allen Arbeiten am Elektrowerkzeug (z.B. Wartung, Werkzeugwechsel etc.) sowie bei dessen Transport und Aufbewahrung den Drehrichtungsumschalter in Mittelstellung.** Bei unbeabsichtigtem Betätigen des Ein-/Ausschalters besteht Verletzungsgefahr.
- ▶ **Verwenden Sie keine 2-seitigen Schrauberklingen, die länger als 25 mm sind.**

Setzen Sie das Schrauberbit **1** direkt in die Werkzeugaufnahme **2** ein.

Betrieb

Inbetriebnahme

Drehrichtung einstellen (siehe Bild C)

Mit dem Drehrichtungsumschalter **9** können Sie die Drehrichtung des Elektrowerkzeuges ändern. Bei gedrücktem Ein-/Ausschalter **8** ist dies jedoch nicht möglich.

Rechtslauf: Zum Eindrehen von Schrauben drücken Sie den Drehrichtungsumschalter **9** nach links bis zum Anschlag durch.

 Die Drehrichtungsanzeige Rechtslauf **4** leuchtet bei betätigtem Ein-/Ausschalter **8** und laufendem Motor.

Linkslauf: Zum Lösen bzw. Herausdrehen von Schrauben drücken Sie den Drehrichtungsumschalter **9** nach rechts bis zum Anschlag durch.

 Die Drehrichtungsanzeige Linkslauf **6** leuchtet bei betätigtem Ein-/Ausschalter **8** und laufendem Motor.

Drehmoment vorwählen

Mit dem Einstellring Drehmomentvorwahl **3** können Sie das benötigte Drehmoment in 10 Stufen vorwählen. Sobald das eingestellte Drehmoment erreicht ist, wird das Einsatzwerkzeug gestoppt.

Stufe 1:

Kleineres Drehmoment zum Eindrehen von Schrauben mit kleinem Durchmesser oder in weiche Werkstoffe.

Stufe 10:

Größeres Drehmoment zum Eindrehen von Schrauben mit großem Durchmesser oder in harte Werkstoffe.



Ein-/Ausschalten

Drücken Sie zur **Inbetriebnahme** des Elektrowerkzeuges den Ein-/Ausschalter **8** und halten Sie ihn gedrückt.

Die Lampe **7** leuchtet bei leicht oder vollständig gedrücktem Ein-/Ausschalter **8** und ermöglicht das Ausleuchten des Arbeitsbereiches bei ungünstigen Lichtverhältnissen.

Um das Elektrowerkzeug **auszuschalten** lassen Sie den Ein-/Ausschalter **8** los.

Drehzahl einstellen

Sie können die Drehzahl des eingeschalteten Elektrowerkzeugs stufenlos regulieren, je nachdem, wie weit Sie den Ein-/Ausschalter **8** eindrücken.

Leichter Druck auf den Ein-/Ausschalter **8** bewirkt eine niedrige Drehzahl. Mit zunehmenden Druck erhöht sich die Drehzahl.

Vollautomatische Spindelarrretierung (Auto-Lock)

Bei nicht gedrücktem Ein-/Ausschalter **8** wird die Bohrspindel und damit die Werkzeugaufnahme arretiert.

Dies ermöglicht das Eindrehen von Schrauben auch bei entlademem Akku bzw. das Verwenden des Elektrowerkzeuges als Schraubendreher.

Temperaturabhängiger Überlastschutz

Bei bestimmungsgemäßen Gebrauch kann das Elektrowerkzeug nicht überlastet werden. Bei zu starker Belastung oder Überschreitung der zulässigen Akku-Temperatur von 70 °C schaltet die Elektronik das Elektrowerkzeug ab, bis diese wieder im optimalen Betriebstemperaturbereich ist.

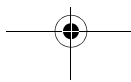
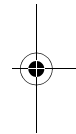
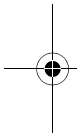

Tiefentladungsschutz

Der Li-Ionen-Akku ist durch die „Electronic Cell Protection (ECP)“ gegen Tiefentladung geschützt. Bei entladem Akku wird das Elektrowerkzeug durch eine Schutzschaltung abgeschaltet: Das Einsatzwerkzeug bewegt sich nicht mehr.

Arbeitshinweise

- ▶ **Setzen Sie das Elektrowerkzeug nur ausgeschaltet auf die Schraube auf.** Sich drehende Einsatzwerkzeuge können abrutschen.

Wartung und Service

Wartung und Reinigung

- ▶ **Bringen Sie vor allen Arbeiten am Elektrowerkzeug (z.B. Wartung, Werkzeugwechsel etc.) sowie bei dessen Transport und Aufbewahrung den Drehrichtungsumschalter in Mittelstellung.** Bei unbeabsichtigtem Betätigen des Ein-/Ausschalters besteht Verletzungsgefahr.
- ▶ **Halten Sie das Elektrowerkzeug und die Lüftungsschlitze sauber, um gut und sicher zu arbeiten.**

Ist der Akku nicht mehr funktionsfähig, wenden Sie sich bitte an eine autorisierte Kundendienststelle für Bosch-Elektrowerkzeuge.

Sollte das Elektrowerkzeug trotz sorgfältiger Herstellungs- und Prüfverfahren einmal ausfallen, ist die Reparatur von einer autorisierten Kundendienststelle für Bosch-Elektrowerkzeuge ausführen zu lassen.



Geben Sie bei allen Rückfragen und Ersatzteilbestellungen bitte unbedingt die 10-stellige Sachnummer laut Typenschild des Elektrowerkzeuges an.

Kundendienst und Kundenberatung

Der Kundendienst beantwortet Ihre Fragen zu Reparatur und Wartung Ihres Produkts sowie zu Ersatzteilen. Explosionszeichnungen und Informationen zu Ersatzteilen finden Sie auch unter:

www.bosch-pt.com

Das Bosch-Kundenberater-Team hilft Ihnen gerne bei Fragen zu Kauf, Anwendung und Einstellung von Produkten und Zubehör.

www.bosch-do-it.de, das Internetportal für Heimwerker und Gartenfreunde.

www.dha.de, das komplette Service-Angebot der Deutschen Heimwerker Akademie.

Deutschland

Robert Bosch GmbH
Servicezentrum Elektrowerkzeuge
Zur Luhne 2
37589 Kalefeld – Willershausen
Tel. Kundendienst: +49 (1805) 70 74 10
Fax: +49 (1805) 70 74 11
E-Mail: Servicezentrum.Elektrowerkzeuge@de.bosch.com
Tel. Kundenberatung: +49 (1803) 33 57 99
Fax: +49 (711) 7 58 19 30
E-Mail: kundenberatung.ew@de.bosch.com

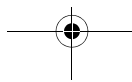
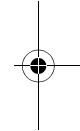
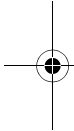



Deutsch | 23



Österreich

ABE Service GmbH
Jochen-Rindt-Straße 1
1232 Wien
Tel. Service: +43 (01) 61 03 80
Fax: +43 (01) 61 03 84 91
Tel. Kundenberater: +43 (01) 7 97 22 30 66
E-Mail: abe@abe-service.co.at

Schweiz

Tel.: +41 (044) 8 47 15 11
Fax: +41 (044) 8 47 15 51

Luxemburg

Tel.: +32 (070) 22 55 65
Fax: +32 (070) 22 55 75
E-Mail: outillage.gereedschap@be.bosch.com

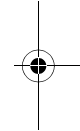
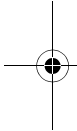

Transport

Der Akku ist nach UN-Handbuch ST/SG/AC.10/11/Rev.3 Teil III, Unterabschnitt 38.3 getestet. Er hat einen wirksamen Schutz gegen inneren Überdruck und Kurzschluss sowie Einrichtungen zur Verhinderung von Gewaltbruch und gefährlichem Rückstrom.

Die im Akku enthaltene Lithiumäquivalent-Menge liegt unterhalb einschlägiger Grenzwerte. Daher unterliegt der Akku weder als Einzelteil noch in ein Gerät eingesetzt den nationalen und internationalen Gefahrgutvorschriften. Die Gefahrgutvorschriften können jedoch beim Transport mehrerer Akkus relevant sein. Es kann in diesem Fall not-

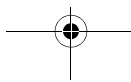



24 | Deutsch



wendig sein, besondere Bedingungen (z. B. bei der Verpackung) einzuhalten. Näheres können Sie einem Merkblatt unter folgender Internetadresse entnehmen:
<http://purchasing.bosch.com/de/start/Allgemeines/Download/index.htm>.

Entsorgung

Elektrowerkzeuge, Zubehör und Verpackungen sollen einer umweltgerechten Wiederverwertung zugeführt werden.

Nur für EU-Länder:



Werfen Sie Elektrowerkzeuge nicht in den Hausmüll!

Gemäß der Europäischen Richtlinie 2002/96/EG über Elektro- und Elektronik-Altgeräte und ihrer Umsetzung in nationales Recht müssen nicht mehr gebrauchsfähige Elektrowerkzeuge getrennt gesammelt und einer umweltgerechten Wiederverwertung zugeführt werden.

Akkus/Batterien:



Li-Ion:

Bitte beachten Sie die Hinweise im Abschnitt „Transport“, Seite 23.

Werfen Sie Akkus/Batterien nicht in den Hausmüll, ins Feuer oder ins Wasser. Akkus/Batterien sollen gesammelt, recycelt oder auf umweltfreundliche Weise entsorgt werden.

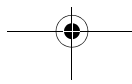



Nur für EU-Länder:

Gemäß der Richtlinie 91/157/EWG müssen defekte oder verbrauchte Akkus/Batterien recycelt werden.

Nicht mehr gebrauchsfähige Akkus/Batterien können direkt abgegeben werden bei:

Deutschland

Recyclingzentrum Elektrowerkzeuge
Osteroder Landstraße 3
37589 Kalefeld

Schweiz

Batrec AG
3752 Wimmis BE

Um den Akku aus dem Elektrowerkzeug zu entnehmen, betätigen Sie den Ein-/Ausschalter **8** solange, bis der Akku vollständig entladen ist. Drehen Sie die Schrauben am Gehäuse heraus und nehmen Sie die Gehäuseschale ab. Trennen Sie die Anschlüsse am Akku und nehmen Sie den Akku heraus.

Änderungen vorbehalten.

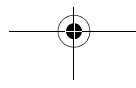
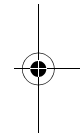
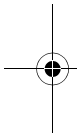



Safety Notes

General Power Tool Safety Warnings

⚠ WARNING Read all safety warnings and all instructions. Failure to follow the warnings and instructions may result in electric shock, fire and/or serious injury.

Save all warnings and instructions for future reference.

The term “power tool” in the warnings refers to your mains-operated (corded) power tool or battery-operated (cordless) power tool.

1) Work area safety

- a) **Keep work area clean and well lit.** Cluttered or dark areas invite accidents.
- b) **Do not operate power tools in explosive atmospheres, such as in the presence of flammable liquids, gases or dust.** Power tools create sparks which may ignite the dust or fumes.
- c) **Keep children and bystanders away while operating a power tool.** Distractions can cause you to lose control.

2) Electrical safety

- a) **Power tool plugs must match the outlet. Never modify the plug in any way. Do not use any adapter plugs with earthed (grounded) power tools.** Unmodified plugs and matching outlets will reduce risk of electric shock.

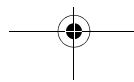

b) Avoid body contact with earthed or grounded surfaces, such as pipes, radiators, ranges and refrigerators. There is an increased risk of electric shock if your body is earthed or grounded.

c) Do not expose power tools to rain or wet conditions. Water entering a power tool will increase the risk of electric shock.

d) Do not abuse the cord. Never use the cord for carrying, pulling or unplugging the power tool. Keep cord away from heat, oil, sharp edges and moving parts. Damaged or entangled cords increase the risk of electric shock.

e) When operating a power tool outdoors, use an extension cord suitable for outdoor use. Use of a cord suitable for outdoor use reduces the risk of electric shock.

f) If operating a power tool in a damp location is unavoidable, use a residual current device (RCD) protected supply. Use of an RCD reduces the risk of electric shock.

3) Personal safety

a) Stay alert, watch what you are doing and use common sense when operating a power tool. Do not use a power tool while you are tired or under the influence of drugs, alcohol or medication. A moment of inattention while operating power tools may result in serious personal injury.

b) Use personal protective equipment. Always wear eye protection. Protective equipment such as dust mask, non-skid safety shoes, hard hat, or hearing protection used for appropriate conditions will reduce personal injuries.

c) Prevent unintentional starting. Ensure the switch is in the off-position before connecting to power source and/or battery pack, picking up or carrying the tool. Carrying power tools with your finger on the switch or energising power tools that have the switch on invites accidents.

d) Remove any adjusting key or wrench before turning the power tool on. A wrench or a key left attached to a rotating part of the power tool may result in personal injury.

e) Do not overreach. Keep proper footing and balance at all times. This enables better control of the power tool in unexpected situations.

f) Dress properly. Do not wear loose clothing or jewellery. Keep your hair, clothing and gloves away from moving parts. Loose clothes, jewellery or long hair can be caught in moving parts.

g) If devices are provided for the connection of dust extraction and collection facilities, ensure these are connected and properly used. Use of dust collection can reduce dust-related hazards.

4) Power tool use and care

a) Do not force the power tool. Use the correct power tool for your application. The correct power tool will do the job better and safer at the rate for which it was designed.

- b) Do not use the power tool if the switch does not turn it on and off.** Any power tool that cannot be controlled with the switch is dangerous and must be repaired.
- c) Disconnect the plug from the power source and/or the battery pack from the power tool before making any adjustments, changing accessories, or storing power tools.** Such preventive safety measures reduce the risk of starting the power tool accidentally.
- d) Store idle power tools out of the reach of children and do not allow persons unfamiliar with the power tool or these instructions to operate the power tool.** Power tools are dangerous in the hands of untrained users.
- e) Maintain power tools. Check for misalignment or binding of moving parts, breakage of parts and any other condition that may affect the power tool's operation. If damaged, have the power tool repaired before use.** Many accidents are caused by poorly maintained power tools.
- f) Keep cutting tools sharp and clean.** Properly maintained cutting tools with sharp cutting edges are less likely to bind and are easier to control.
- g) Use the power tool, accessories and tool bits etc. in accordance with these instructions, taking into account the working conditions and the work to be performed.** Use of the power tool for operations different from those intended could result in a hazardous situation.



5) Battery tool use and care

- a) **Recharge only with the charger specified by the manufacturer.** A charger that is suitable for one type of battery pack may create a risk of fire when used with another battery pack.
- b) **Use power tools only with specifically designated battery packs.** Use of any other battery packs may create a risk of injury and fire.
- c) **When battery pack is not in use, keep it away from other metal objects, like paper clips, coins, keys, nails, screws or other small metal objects, that can make a connection from one terminal to another.** Shorting the battery terminals together may cause burns or a fire.
- d) **Under abusive conditions, liquid may be ejected from the battery; avoid contact. If contact accidentally occurs, flush with water. If liquid contacts eyes, additionally seek medical help.** Liquid ejected from the battery may cause irritation or burns.

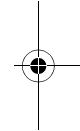
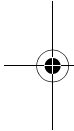

6) Service

- a) **Have your power tool serviced by a qualified repair person using only identical replacement parts.** This will ensure that the safety of the power tool is maintained.

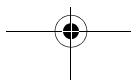

Safety Warnings for Screwdriver

- ▶ **Hold power tool by insulated gripping surfaces, when performing an operation where the fastener may contact hidden wiring.** Fasteners contacting a “live” wire may make exposed metal parts of the power tool “live” and could give the operator an electric shock.
- ▶ **Hold the machine with a firm grip.** High reaction torque can briefly occur while driving in and loosening screws.
- ▶ **Secure the workpiece.** A workpiece clamped with clamping devices or in a vice is held more secure than by hand.
- ▶ **Before any work on the machine (e. g., maintenance, tool change, etc.) as well as during transport and storage, set the rotational direction switch to the centre position.** Unintentional actuation of the On/Off switch can lead to injuries.
- ▶ **Avoid unintentional switching on. Ensure the On/Off switch is in the off position before inserting battery pack.** Carrying the power tool with your finger on the On/Off switch or inserting the battery pack into power tools that have the switch on invites accidents.
- ▶ **Do not open the battery.** Danger of short-circuiting.



Protect the power tool against heat, e. g., also against continuous sun irradiation and fire.

There is danger of explosion.



- ▶ **In case of damage and improper use of the battery, vapours may be emitted. Provide for fresh air and seek medical help in case of complaints.** The vapours can irritate the respiratory system.
- ▶ **When the battery is defective, liquid can escape and come into contact with adjacent components. Check any parts concerned.** Clean such parts or replace them, if required.

Safety Warnings for battery chargers



Keep the battery charger away from rain or moisture. Penetration of water in the battery charger increases the risk of an electric shock.

- ▶ **Do not charge other batteries.** The battery charger is suitable only for charging Bosch lithium ion batteries within the listed voltage range. Otherwise there is danger of fire and explosion.
- ▶ **Keep the battery charger clean.** Contamination can lead to danger of an electric shock.
- ▶ **Before each use, check the battery charger, cable and plug. If damage is detected, do not use the battery charger. Never open the battery charger yourself. Have repairs performed only by a qualified technician and only using original spare parts.** Damaged battery chargers, cables and plugs increase the risk of an electric shock.
- ▶ **Do not operate the battery charger on easily inflammable surfaces (e. g., paper, textiles, etc.) or surroundings.** The heating of the battery charger during the charging process can pose a fire hazard.

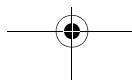
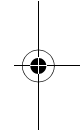
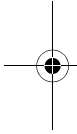

Functional Description



Read all safety warnings and all instructions. Failure to follow the warnings and instructions may result in electric shock, fire and/or serious injury.

Intended Use

The machine is intended for driving in and loosening screws.

Use the machine only when you can fully assess all functions and handle them without limitation, or after having received appropriate instructions.

Product Features

The numbering of the product features refers to the illustration of the machine on the graphics page.

- 1 Screwdriver bit*
- 2 Tool holder
- 3 Torque preselection ring
- 4 Indicator for right rotation
- 5 Battery charge-control indicator
- 6 Indicator for left rotation
- 7 "Power Light"
- 8 On/Off switch
- 9 Rotational direction switch
- 10 Battery charger

***Accessories shown or described are not part of the standard delivery scope of the product. A complete overview of accessories can be found in our accessories program.**

34 | English

Technical Data

Cordless Screwdriver		PSR 7,2 LI
Article number		3 603 J57 7..
Rated voltage	V=	7.2
No-load speed	min ⁻¹	0–230
Max. torque for hard/soft screwdriving application according to ISO 5393	Nm	10/6
Max. screw dia.	mm	6
Weight according to EPTA-Procedure 01/2003	kg	0.5
Battery		Li-Ion
Capacity	Ah	1.3
Number of battery cells		2
Battery Charger		
Article number		2 607 225 553 (EU) 2 607 225 555 (UK)
Charging time	h	5.0

Please observe the article number on the type plate of your machine. The trade names of the individual machines may vary.

Noise/Vibration Information

Measured values determined according to EN 60745.

Typically the A-weighted sound pressure level of the product is less than 70 dB(A). Uncertainty K = 3 dB.

The noise level when working can exceed 80 dB(A).

Wear hearing protection!

Vibration total values (triax vector sum) determined according to EN 60745:

Screwdriving without impact: Vibration emission value $a_h < 2.5 \text{ m/s}^2$, Uncertainty K = 1.5 m/s^2 .

The vibration emission level given in this information sheet has been measured in accordance with a standardised test given in EN 60745 and may be used to compare one tool with another. It may be used for a preliminary assessment of exposure.

The declared vibration emission level represents the main applications of the tool. However if the tool is used for different applications, with different accessories or poorly maintained, the vibration emission may differ. This may significantly increase the exposure level over the total working period.

An estimation of the level of exposure to vibration should also take into account the times when the tool is switched off or when it is running but not actually doing the job. This may significantly reduce the exposure level over the total working period.

Identify additional safety measures to protect the operator from the effects of vibration such as: maintain the tool and the accessories, keep the hands warm, organisation of work patterns.

Declaration of Conformity

We declare under our sole responsibility that the product described under "Technical data" is in conformity with the following standards or standardization documents: EN 60745 (battery powered product) and EN 60335 (battery charger) according to the provisions of the directives 2006/95/EC, 2004/108/EC, 98/37/EC (until 28 Dec 2009), 2006/42/EC (from 29 Dec 2009).



Technical file at:

Robert Bosch GmbH, PT/ESC,
D-70745 Leinfelden-Echterdingen

 08

Dr. Egbert Schneider
Senior Vice President
Engineering

Dr. Eckerhard Strötgen
Head of Product
Certification

 i.v. 

Robert Bosch GmbH, Power Tools Division
D-70745 Leinfelden-Echterdingen
16.09.2008

Assembly

Battery Charging (see figure A)

- ▶ **Do not use other battery chargers.** The supplied battery charger is designed for the Lithium-Ion battery in your machine.
- ▶ **Observe the mains voltage!** The voltage of the power supply must correspond with the data given on the nameplate of the battery charger. Battery chargers marked with 230 V can also be operated with 220 V.



Note: The battery is supplied partially charged. To ensure full capacity of the battery, completely charge the battery in the battery charger before using your power tool for the first time.

The lithium ion battery can be charged at any time without reducing its service life. Interrupting the charging procedure does not damage the battery.

The Li-ion battery is protected against deep discharging by the “Electronic Cell Protection (ECP)”. When the battery is empty, the machine is switched off by means of a protective circuit: The inserted tool no longer rotates.

⚠ WARNING Do not continue to press the On/Off switch after the machine has been automatically switched off. The battery can be damaged.

The charging procedure starts as soon as the main plug of the battery charger is inserted into the socket and the cordless screwdriver is afterwards placed on the battery charger **10**.

The battery charge-control indicator **5** indicates the charging progress. During the charging procedure, the indicator **flashes** green. The battery is fully charged when the indicator lights up green **continuously**.

During the charging procedure, the handle of the machine warms up. This is normal.

Disconnect the battery charger from the mains supply when not using it for longer periods.

The power tool cannot be used during the charge procedure; it is not defective when inoperative during the charging procedure.

Observe the notes for disposal.

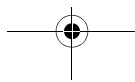
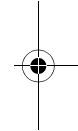
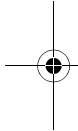



Changing the Tool (see figure B)

- ▶ **Before any work on the machine (e. g., maintenance, tool change, etc.) as well as during transport and storage, set the rotational direction switch to the centre position.** Unintentional actuation of the On/Off switch can lead to injuries.
- ▶ **Do not use double-sided screwdriver blades that are longer than 25 mm.**

Insert the screwdriver bit **1** directly into the tool holder **2**.

Operation

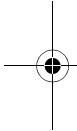

Starting Operation

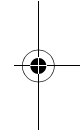

Reversing the Rotational Direction (see figure C)

The rotational direction switch **9** is used to reverse the rotational direction of the machine. However, this is not possible with the On/Off switch **8** actuated.

Right rotation: For driving in screws, push the rotational direction switch **9** left to the stop.

 The indicator for right rotation **4** lights up when the On/Off switch **8** is actuated and the motor is running.

Left Rotation: For loosening or unscrewing screws, push the rotational direction switch **9** right to the stop.

 The indicator for left rotation **6** lights up when the On/Off switch **8** is actuated and the motor is running.

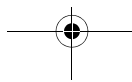



Setting the Torque

With the torque preselection ring **3**, the required torque can be preselected in 10 steps. The inserted tool is stopped as soon as the set torque is reached.

Position 1:

Lower torque for screwing in screws with small diameter or into soft materials.

Position 10:

Higher torque for screwing in screws with large diameter or into hard materials.

Switching On and Off

To **start** the machine, press the On/Off switch **8** and keep it pressed.

The light **7** is lit when the On/Off switch **8** is slightly or completely pressed in and permits to light the work area when the lighting conditions are bad.

To switch off the machine, **release** the On/Off switch **8**.

Adjusting the Speed

The speed of the switched on power tool can be variably adjusted, depending on how far the On/Off switch **8** is pressed.

Light pressure on the On/Off switch **8** results in a low rotational speed. Further pressure on the switch results in an increase in speed.

Fully automatic spindle locking (Auto-lock)

When the On/Off switch **8** is not pressed, the drill spindle and thus the tool holder are locked.

This enables screws to be screwed in, even when the battery is empty and allows for the machine to be used as a screwdriver.

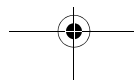
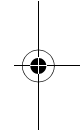
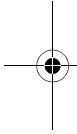

Temperature Dependent Overload Protection

When using as intended for, the power tool cannot be subject to overload. When the load is too high or the allowable battery temperature of 70 °C is exceeded, the electronic control switches off the power tool until the temperature is in the optimum temperature range again.

Protection Against Deep Discharging

The Li-ion battery is protected against deep discharging by the “Electronic Cell Protection (ECP)”. When the battery is empty, the machine is switched off by means of a protective circuit: The inserted tool no longer rotates.

Working Advice

- ▶ **Apply the power tool to the screw only when it is switched off.** Rotating tool inserts can slip off.

Maintenance and Service

Maintenance and Cleaning

- ▶ **Before any work on the machine (e. g., maintenance, tool change, etc.) as well as during transport and storage, set the rotational direction switch to the centre position.** Unintentional actuation of the On/Off switch can lead to injuries.
- ▶ **For safe and proper working, always keep the machine and ventilation slots clean.**



When the battery is no longer operative, please refer to an authorised after-sales service agent for Bosch power tools.

If the machine should fail despite the care taken in manufacturing and testing procedures, repair should be carried out by an after-sales service centre for Bosch power tools.

In all correspondence and spare parts order, please always include the 10-digit article number given on the type plate of the machine.

After-sales Service and Customer Assistance

Our after-sales service responds to your questions concerning maintenance and repair of your product as well as spare parts. Exploded views and information on spare parts can also be found under:

www.bosch-pt.com

Our customer consultants answer your questions concerning best buy, application and adjustment of products and accessories.

Great Britain

Robert Bosch Ltd. (B.S.C.)
P.O. Box 98
Broadwater Park
North Orbital Road
Denham
Uxbridge
UB 9 5HJ
Tel. Service: +44 (0844) 736 0109
Fax: +44 (0844) 736 0146
E-Mail: SPT-Technical.de@de.bosch.com

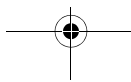
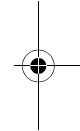
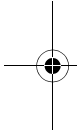



Ireland

Origo Ltd.
Unit 23 Magna Drive
Magna Business Park
City West
Dublin 24
Tel. Service: +353 (01) 4 66 67 00
Fax: +353 (01) 4 66 68 88

Australia, New Zealand and Pacific Islands

Robert Bosch Australia Pty. Ltd.
Power Tools
Locked Bag 66
Clayton South VIC 3169
Customer Contact Center
Inside Australia:
Phone: +61 (01300) 307 044
Fax: +61 (01300) 307 045
Inside New Zealand:
Phone: +64 (0800) 543 353
Fax: +64 (0800) 428 570
Outside AU and NZ:
Phone: +61 (03) 9541 5555
www.bosch.com.au

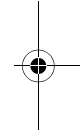
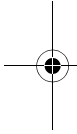

Transport

The battery is tested according to UN document ST/SG/AC.10/11/Rev.3 Part III, subsection 38.3. It has effective protection against internal overpressure and short circuiting as well as devices for the prevention of violent rupture and dangerous reverse current flow.

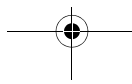

The lithium-equivalent content in the battery is below applicable limit values. Therefore, the battery is not subject to national or international regulations pertaining to dangerous mediums, neither as an individual component nor when inserted into a machine. However, the regulations governing dangerous goods may be relevant when transporting several batteries. In this case, it can be necessary to comply with special conditions (e.g., concerning the packaging). For more information, please refer to the instruction sheet (in English) under the following Internet address: <http://purchasing.bosch.com/en/start/Allgemeines/Download/index.htm>.

Disposal

The machine, accessories and packaging should be sorted for environmental-friendly recycling.

Only for EC countries:



Do not dispose of power tools into household waste!

According the European Guideline 2002/96/EC for Waste Electrical and Electronic Equipment and its implementation into national right, power tools that are no

longer usable must be collected separately and disposed of in an environmentally correct manner.

**Battery packs/batteries:****Li-ion:**

Please observe the instructions in section "Transport", page 42.

Do not dispose of battery packs/batteries into household waste, fire or water. Battery packs/batteries should be collected, recycled or disposed of in an environmental-friendly manner.

Only for EC countries:

Defective or dead out battery packs/batteries must be recycled according the guideline 91/157/EEC.

Batteries no longer suitable for use can be directly returned at:

Great Britain

Robert Bosch Ltd. (B.S.C.)

P.O. Box 98

Broadwater Park

North Orbital Road

Denham

Uxbridge

UB 9 5HJ

Tel. Service: +44 (0844) 736 0109

Fax: +44 (0844) 736 0146

E-Mail: SPT-Technical.de@de.bosch.com

When removing the battery from the machine, actuate the On/Off switch **8** until the battery is completely discharged. Unscrew the screw in the casing and take off the casing shell. Disconnect the connections on the battery and remove the battery.

Subject to change without notice.

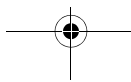

Consignes de sécurité

Avertissements de sécurité généraux pour l'outil

⚠ AVERTISSEMENT Lire tous les avertissements de sécurité et toutes les instructions. Ne pas suivre les avertissements et instructions peut donner lieu à un choc électrique, un incendie et/ou une blessure sérieuse.

Conserver tous les avertissements et toutes les instructions pour pouvoir s'y reporter ultérieurement.

Le terme « outil » dans les avertissements fait référence à votre outil électrique alimenté par le secteur (avec cordon d'alimentation) ou votre outil fonctionnant sur batterie (sans cordon d'alimentation).

1) Sécurité de la zone de travail

- a) **Conserver la zone de travail propre et bien éclairée.** Les zones en désordre ou sombres sont propices aux accidents.
- b) **Ne pas faire fonctionner les outils électriques en atmosphère explosive, par exemple en présence de liquides inflammables, de gaz ou de poussières.** Les outils électriques produisent des étincelles qui peuvent enflammer les poussières ou les fumées.
- c) **Maintenir les enfants et les personnes présentes à l'écart pendant l'utilisation de l'outil.** Les distractions peuvent vous faire perdre le contrôle de l'outil.

2) Sécurité électrique

- a) Il faut que les fiches de l'outil électrique soient adaptées au socle. Ne jamais modifier la fiche de quelque façon que ce soit. Ne pas utiliser d'adaptateurs avec des outils à branchement de terre.**

Des fiches non modifiées et des socles adaptés réduiront le risque de choc électrique.

- b) Éviter tout contact du corps avec des surfaces reliées à la terre telles que les tuyaux, les radiateurs, les cuisinières et les réfrigérateurs.** Il existe un risque accru de choc électrique si votre corps est relié à la terre.

- c) Ne pas exposer les outils à la pluie ou à des conditions humides.** La pénétration d'eau à l'intérieur d'un outil augmentera le risque de choc électrique.

- d) Ne pas maltraiter le cordon. Ne jamais utiliser le cordon pour porter, tirer ou débrancher l'outil. Maintenir le cordon à l'écart de la chaleur, du lubrifiant, des arêtes ou des parties en mouvement.** Les cordons endommagés ou emmêlés augmentent le risque de choc électrique.

- e) Lorsqu'on utilise un outil à l'extérieur, utiliser un prolongateur adapté à l'utilisation extérieure.** L'utilisation d'un cordon adapté à l'utilisation extérieure réduit le risque de choc électrique.

- f) Si l'usage d'un outil dans un emplacement humide est inévitable, utiliser une alimentation protégée par un dispositif à courant différentiel résiduel (RCD). L'usage d'un RCD réduit le risque de choc électrique.**

3) Sécurité des personnes

- a) Rester vigilant, regarder ce que vous êtes en train de faire et faire preuve de bon sens dans votre utilisation de l'outil. Ne pas utiliser un outil lorsque vous êtes fatigué ou sous l'emprise de drogues, d'alcool ou de médicaments.** Un moment d'inattention en cours d'utilisation d'un outil peut entraîner des blessures graves des personnes.
- b) Utiliser un équipement de sécurité. Toujours porter une protection pour les yeux.** Les équipements de sécurité tels que les masques contre les poussières, les chaussures de sécurité antidérapantes, les casques ou les protections acoustiques utilisés pour les conditions appropriées réduiront les blessures de personnes.
- c) Éviter tout démarrage intempestif. S'assurer que l'interrupteur est en position arrêt avant de brancher l'outil au secteur et/ou au bloc de batteries, de le ramasser ou de le porter.** Porter les outils en ayant le doigt sur l'interrupteur ou brancher des outils dont l'interrupteur est en position marche est source d'accidents.
- d) Retirer toute clé de réglage avant de mettre l'outil en marche.** Une clé laissée fixée sur une partie tournante de l'outil peut donner lieu à des blessures de personnes.
- e) Ne pas se précipiter. Garder une position et un équilibre adaptés à tout moment.** Cela permet un meilleur contrôle de l'outil dans des situations inattendues.

- f) S'habiller de manière adaptée. Ne pas porter de vêtements amples ou de bijoux. Garder les cheveux, les vêtements et les gants à distance des parties en mouvement.** Des vêtements amples, des bijoux ou les cheveux longs peuvent être pris dans des parties en mouvement.
- g) Si des dispositifs sont fournis pour le raccordement d'équipements pour l'extraction et la récupération des poussières, s'assurer qu'ils sont connectés et correctement utilisés.** Utiliser des collecteurs de poussière peut réduire les risques dus aux poussières.

4) Utilisation et entretien de l'outil

- a) Ne pas forcer l'outil. Utiliser l'outil adapté à votre application.** L'outil adapté réalisera mieux le travail et de manière plus sûre au régime pour lequel il a été construit.
- b) Ne pas utiliser l'outil si l'interrupteur ne permet pas de passer de l'état de marche à arrêt et vice versa.** Tout outil qui ne peut pas être commandé par l'interrupteur est dangereux et il faut le réparer.
- c) Débrancher la fiche de la source d'alimentation en courant et/ou le bloc de batteries de l'outil avant tout réglage, changement d'accessoires ou avant de ranger l'outil.** De telles mesures de sécurité préventives réduisent le risque de démarrage accidentel de l'outil.
- d) Conserver les outils à l'arrêt hors de la portée des enfants et ne pas permettre à des personnes ne connaissant pas l'outil ou les présentes instructions de le faire fonctionner.** Les outils sont dangereux entre les mains d'utilisateurs novices.

e) Observer la maintenance de l'outil. Vérifier qu'il n'y a pas de mauvais alignement ou de blocage des parties mobiles, des pièces cassées ou toute autre condition pouvant affecter le fonctionnement de l'outil. En cas de dommages, faire réparer l'outil avant de l'utiliser. De nombreux accidents sont dus à des outils mal entretenus.

f) Garder affûtés et propres les outils permettant de couper. Des outils destinés à couper correctement entretenus avec des pièces coupantes tranchantes sont moins susceptibles de bloquer et sont plus faciles à contrôler.

g) Utiliser l'outil, les accessoires et les lames etc., conformément à ces instructions, en tenant compte des conditions de travail et du travail à réaliser. L'utilisation de l'outil pour des opérations différentes de celles prévues pourrait donner lieu à des situations dangereuses.

5) Utilisation des outils fonctionnant sur batteries et précautions d'emploi

a) Ne recharger qu'avec le chargeur spécifié par le fabricant. Un chargeur qui est adapté à un type de bloc de batteries peut créer un risque de feu lorsqu'il est utilisé avec un autre type de bloc de batteries.

b) N'utiliser les outils qu'avec des blocs de batteries spécifiquement désignés. L'utilisation de tout autre bloc de batteries peut créer un risque de blessure et de feu.

c) Lorsqu'un bloc de batteries n'est pas utilisé, le maintenir à l'écart de tout autre objet métallique, par exemple trombones, pièces de monnaie, clés, clous, vis ou autres objets de petite taille qui peuvent donner lieu à une connexion d'une borne à une autre. Le court-circuitage des bornes d'une batterie entre elles peut causer des brûlures ou un feu.

d) Dans de mauvaises conditions, du liquide peut être éjecté de la batterie; éviter tout contact. En cas de contact accidentel, nettoyer à l'eau. Si le liquide entre en contact avec les yeux, rechercher en plus une aide médicale. Le liquide éjecté des batteries peut causer des irritations ou des brûlures.

6) Maintenance et entretien

a) Faire entretenir l'outil par un réparateur qualifié utilisant uniquement des pièces de rechange identiques. Cela assurera que la sécurité de l'outil est maintenue.

Avertissements de sécurité pour visseuses

- ▶ **Tenir l'outil par les surfaces de préhension isolées, lors de la réalisation d'une opération au cours de laquelle le dispositif de serrage peut entrer en contact avec un câblage non apparent.** Le contact avec un fil « sous tension » peut également mettre « sous tension » les parties métalliques exposées de l'outil électrique et provoquer un choc électrique sur l'opérateur.
- ▶ **Bien tenir l'appareil électroportatif.** Lors du vissage ou du dévissage, il peut y avoir des couples de réaction instantanés élevés.

- ▶ **Bloquer la pièce à travailler.** Une pièce à travailler serrée par des dispositifs de serrage ou dans un étau est fixée de manière plus sûre que tenue dans les mains.
- ▶ **Avant d'effectuer des travaux sur l'appareil (p. ex. travaux d'entretien, changement d'outils, etc.) et avant de le transporter ou stocker, toujours mettre le commutateur de sens de rotation en position médiane.** Il y a risque de blessure lorsqu'on appuie par mégarde sur l'interrupteur Marche/Arrêt.
- ▶ **Éviter une mise en marche par mégarde. S'assurer que l'interrupteur Marche/Arrêt est effectivement en position d'arrêt avant de monter un accu.** Le fait de porter l'outil électroportatif en laissant le doigt sur l'interrupteur Marche/Arrêt ou de mettre en place l'accu dans l'outil électroportatif lorsque celui-ci est en marche peut entraîner des accidents.
- ▶ **Ne pas ouvrir l'accu.** Risque de court-circuit.
 **Protégez l'outil électroportatif de toute source de chaleur, comme par ex. l'exposition directe au soleil et au feu.** Il y a risque d'explosion.
- ▶ **En cas d'endommagement et d'utilisation non conforme de l'accu, des vapeurs peuvent s'échapper. Ventiler le lieu de travail et, en cas de malaises, consulter un médecin.** Les vapeurs peuvent entraîner des irritations des voies respiratoires.
- ▶ **Lorsque l'accu est défectueux, du liquide peut sortir et enduire les objets avoisinants. Contrôler les éléments concernés.** Les nettoyer ou, le cas échéant, les remplacer.

Instructions de sécurité pour chargeurs



Ne pas exposer le chargeur à la pluie ou à l'humidité. La pénétration d'eau dans un chargeur augmente le risque d'un choc électrique.

- ▶ **Ne pas charger des accus autres que ceux indiqués ci-dessous.** Le chargeur n'est approprié que pour charger des accus à ions lithium Bosch des tensions indiquées dans les caractéristiques techniques. Sinon, il y a risque d'incendie et d'explosion.
- ▶ **Maintenir le chargeur propre.** Un encrassement cause le risque de choc électrique.
- ▶ **Avant toute utilisation, contrôler le chargeur, la fiche et le câble. Ne pas utiliser le chargeur si des défauts sont constatés. Ne pas ouvrir le chargeur soi-même et ne le faire réparer que par une personne qualifiée et seulement avec des pièces de rechange d'origine.** Des chargeurs, câbles et fiches endommagés augmentent le risque d'un choc électrique.
- ▶ **Ne pas utiliser le chargeur sur un support facilement inflammable (tel que papier, textiles etc.) ou dans un environnement inflammable.** L'échauffement du chargeur lors du processus de charge augmente le risque d'incendie.

Description du fonctionnement



Lire tous les avertissements et indications.

Le non-respect des avertissements et instructions indiqués ci-après peut entraîner un choc électrique, un incendie et/ou de graves blessures sur les personnes.



Utilisation conforme

L'appareil est conçu pour visser et dévisser des vis.

N'utilisez l'outil électroportatif que lorsque vous vous rendez compte de toutes ses fonctions et êtes capable de l'utiliser sans réserves ou après avoir reçu des instructions correspondantes.

Éléments de l'appareil

La numérotation des éléments de l'appareil se réfère à la représentation de l'outil électroportatif sur la page graphique.

- 1 Embout*
- 2 Porte-outil
- 3 Bague de réglage de présélection du couple
- 4 Indicateur du sens de rotation vers la droite
- 5 Voyant lumineux indiquant l'état de charge de l'accu
- 6 Indicateur du sens de rotation vers la gauche
- 7 Lampe « Power Light »
- 8 Interrupteur Marche/Arrêt
- 9 Commutateur du sens de rotation
- 10 Chargeur

***Les accessoires décrits ou montrés ne sont pas compris dans l'emballage standard. Vous trouverez les accessoires complets dans notre programme d'accessoires.**

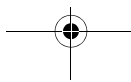
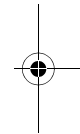
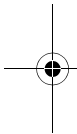

54 | Français

Caractéristiques techniques

Visseuse sans fil		PSR 7,2 LI
N° d'article		3 603 J57 7..
Tension nominale	V=	7,2
Vitesse de rotation en marche à vide	tr/min	0-230
Couple max. vissage dur/tendre suivant ISO 5393	Nm	10/6
Ø max. de vis	mm	6
Poids suivant EPTA-Procédure 01/2003	kg	0,5
Accu		ions lithium
Capacité	Ah	1,3
Nombre éléments d'accu		2
Chargeur		
N° d'article		2 607 225 553 (EU) 2 607 225 555 (UK)
Durée de charge	h	5,0

Respectez impérativement le numéro d'article se trouvant sur la plaque signalétique de l'outil électroportatif. Les désignations commerciales des différents outils électroportatifs peuvent varier.



Bruits et vibrations

Valeurs de mesure déterminées conformément à EN 60745.

La mesure réelle (A) du niveau de pression acoustique de l'outil est en général inférieur à 70 dB(A). Incertitude $K = 3$ dB.

Le niveau sonore en fonctionnement peut dépasser 80 dB(A).

Porter une protection acoustique !

Valeurs totales des vibrations (somme de vecteurs de trois sens) relevées conformément à EN 60745 :

Vissage : Valeur d'émission vibratoire $a_h < 2,5$ m/s², Incertitude $K = 1,5$ m/s².

L'amplitude d'oscillation indiquée dans ces instructions d'utilisation a été mesurée conformément à la norme EN 60745 et peut être utilisée pour une comparaison d'outils électroportatifs. Elle est également appropriée pour une estimation préliminaire de la sollicitation vibratoire.

L'amplitude d'oscillation représente les utilisations principales de l'outil électroportatif. Si l'outil électroportatif est cependant utilisé pour d'autres applications, avec d'autres outils de travail ou avec un entretien non approprié, l'amplitude d'oscillation peut être différente. Ceci peut augmenter considérablement la sollicitation vibratoire pendant toute la durée de travail.

Pour une estimation précise de la sollicitation vibratoire, il est recommandé de prendre aussi en considération les espaces de temps pendant lesquels l'appareil est éteint ou en fonctionnement, mais pas vraiment utilisé. Ceci peut réduire considérablement la sollicitation vibratoire pendant toute la durée de travail.

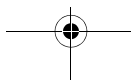
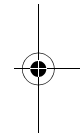
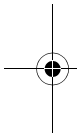



56 | Français



Déterminez des mesures de protection supplémentaires pour protéger l'utilisateur des effets de vibrations, telles que par exemple : Entretien de l'outil électroportatif et des outils de travail, maintenir les mains chaudes, organisation des opérations de travail.

Déclaration de conformité

Nous déclarons sous notre propre responsabilité que le produit décrit sous « Caractéristiques techniques » est en conformité avec les normes ou documents normatifs suivants : EN 60745 (appareils sans fil) respectivement EN 60335 (chargeurs électriques) conformément aux termes des réglementations 2006/95/CE, 2004/108/CE, 98/37/CE (jusqu'au 28.12.2009), 2006/42/CE (à partir du 29.12.2009).

Dossier technique auprès de :
Robert Bosch GmbH, PT/ESC,
D-70745 Leinfelden-Echterdingen

 08

Dr. Egbert Schneider Senior Vice President Engineering	Dr. Eckerhard Strötgen Head of Product Certification
--	--

ppa. Schneider *i.v. Strötgen*

Robert Bosch GmbH, Power Tools Division
D-70745 Leinfelden-Echterdingen
16.09.2008

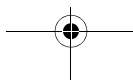

Montage

Charger l'accu (voir figure A)

- ▶ **Ne pas utiliser un autre chargeur.** Le chargeur fourni avec l'appareil est adapté à l'accumulateur à ions lithium intégré dans votre appareil électroportatif.
- ▶ **Tenir compte de la tension du réseau !** La tension de la source de courant doit coïncider avec les indications se trouvant sur la plaque signalétique du chargeur. Les chargeurs marqués 230 V peuvent également être mis en service sous 220 V.

Note : L'accu est fourni en état de charge faible. Afin de garantir la puissance complète de l'accu, charger complètement l'accu dans le chargeur avant la première mise en service.

L'accu à ions lithium peut être rechargé à tout moment, sans que sa durée de vie n'en soit réduite. Le fait d'interrompre le processus de charge n'endommage pas l'accu.

Grâce à la « Electronic Cell Protection (ECP) », l'accu à ions lithium est protégé contre une décharge profonde. Lorsque l'accumulateur est déchargé, l'outil électroportatif s'arrête grâce à un dispositif d'arrêt de protection : L'outil de travail ne tourne plus.

ATTENTION Après la mise hors fonctionnement automatique de l'outil électroportatif, **ne plus appuyer sur l'interrupteur Marche/Arrêt.** L'accu peut être endommagé.

Le processus de charge commence dès que la fiche de secteur du chargeur est branchée sur la prise de courant et que la visseuse sans fil est placée sur le chargeur **10**.

**58 | Français**

Le voyant lumineux indiquant l'état de charge de l'accu **5** indique la progression du processus de charge. Le voyant lumineux **clignote** vert lors du processus de charge. L'accu est complètement chargé lorsque le voyant lumineux vert **reste constamment allumé**.

La poignée de l'outil électroportatif chauffe durant le processus de charge. Ceci est normal.

Débrancher le chargeur lorsque celui-ci n'est pas utilisé pendant un certain temps.

Pendant le processus de charge, il n'est pas possible d'utiliser l'outil électroportatif ; il n'est pas défectueux lorsqu'il ne fonctionne pas pendant le processus de charge.

Respectez les indications concernant l'élimination.

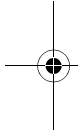

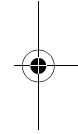
Changement de l'outil (voir figure B)

- ▶ **Avant d'effectuer des travaux sur l'appareil (p. ex. travaux d'entretien, changement d'outils, etc.) et avant de le transporter ou stocker, toujours mettre le commutateur de sens de rotation en position médiane.** Il y a risque de blessure lorsqu'on appuie par mégarde sur l'interrupteur Marche/Arrêt.
- ▶ **Ne pas utiliser les embouts de tournevis à deux faces qui mesurent plus de 25 mm.**

Monter l'embout **1** directement dans le porte-outil **2**.

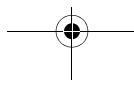

Mise en marche

Mise en service

Régler le sens de rotation (voir figure C)

Avec le commutateur de sens de rotation **9** le sens de rotation de l'outil électroportatif peut être inversé. Ceci n'est cependant pas possible, quand l'interrupteur Marche/Arrêt **8** est appuyé.

Rotation à droite : Pour serrer des vis, tourner le commutateur du sens de rotation **9** à fond vers la gauche.

 L'indicateur du sens de rotation vers la droite **4** s'allume lorsque l'interrupteur Marche/Arrêt **8** est actionné et que le moteur tourne.

Rotation à gauche : Pour desserrer ou dévisser des vis, tourner le commutateur du sens de rotation **9** à fond vers la droite.

 L'indicateur du sens de rotation vers la gauche **6** s'allume lorsque l'interrupteur Marche/Arrêt **8** est actionné et que le moteur tourne.

Présélection du couple

A l'aide de la bague de réglage de présélection du couple **3**, il est possible de présélectionner le couple nécessaire par 10 étapes. Dès que le couple réglé est atteint, l'outil de travail est arrêté.

Etape 1 :

Plus petit couple pour le vissage de vis d'un petit diamètre ou dans des matériaux tendres.

Etape 10 :

Couple plus élevé pour le vissage de vis d'un grand diamètre ou dans des matériaux durs.

Mise en Marche/Arrêt

Pour **mettre** l'outil électroportatif en marche, appuyer sur l'interrupteur Marche/Arrêt **8** et le maintenir vous appuyez.

La lampe **7** s'allume lorsque l'interrupteur Marche/Arrêt **8** est enfoncé un peu ou complètement et permet d'éclairer la zone de travail lorsque l'éclairage est mauvais.

Pour arrêter l'outil **électroportatif** vous relâchez l'interrupteur Marche/Arrêt **8**.

Réglage de la vitesse de rotation

Il est possible de régler sans à-coups la vitesse de rotation de l'outil électroportatif en opération suivant la façon dont on appuie sur l'interrupteur Marche/Arrêt **8**.

Une pression légère sur l'interrupteur Marche/Arrêt **8** entraîne une faible vitesse de rotation. Plus la pression augmente, plus la vitesse de rotation est élevée.

Blocage automatique de la broche (Auto-Lock)

L'interrupteur Marche/Arrêt **8** n'étant pas appuyé, la broche de perçage et donc le porte-outil sont bloqués.

Ceci permet de visser des vis même si l'accu est déchargé ou bien de se servir de l'outil électroportatif comme d'un tournevis classique.

Protection contre surcharge en fonction de la température

Si vous utilisez l'outil électroportatif conformément à sa conception, il ne peut pas subir de surcharge. Lors d'une sollicitation trop élevée ou lors d'un dépassement de la température d'accu admissible de 70 °C, l'électronique arrête l'outil électroportatif jusqu'à ce que la température se retrouve dans la plage de température de service admissible.



Protection de décharge profonde

Grâce à la « Electronic Cell Protection (ECP) », l'accu à ions lithium est protégé contre une décharge profonde. Lorsque l'accumulateur est déchargé, l'outil électroportatif s'arrête grâce à un dispositif d'arrêt de protection : L'outil de travail ne tourne plus.

Instructions d'utilisation

- **Poser l'outil électroportatif sur la vis seulement lorsque l'appareil est éteint.** Les outils de travail en rotation peuvent glisser.

Entretien et service après-vente

Nettoyage et entretien

- **Avant d'effectuer des travaux sur l'appareil (p. ex. travaux d'entretien, changement d'outils, etc.) et avant de le transporter ou stocker, toujours mettre le commutateur de sens de rotation en position médiane.** Il y a risque de blessure lorsqu'on appuie par mégarde sur l'interrupteur Marche/Arrêt.
- **Tenez toujours propres l'outil électroportatif ainsi que les ouïes de ventilation afin d'obtenir un travail impeccable et sûr.**

Au cas où l'accu ne fonctionnerait plus, veuillez vous adresser à une station de service après-vente agréée pour outillage Bosch.

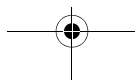
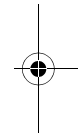
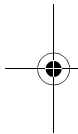



62 | Français



Si, malgré tous les soins apportés à la fabrication et au contrôle de l'appareil, celui-ci devait avoir un défaut, la réparation ne doit être confiée qu'à une station de service après-vente agréée pour outillage Bosch.

Pour toute demande de renseignement ou commande de pièces de rechange, précisez-nous impérativement le numéro d'article à dix chiffres de l'outil électroportatif indiqué sur la plaque signalétique.

Service après-vente et assistance des clients

Notre service après-vente répond à vos questions concernant la réparation et l'entretien de votre produit et les pièces de rechange. Vous trouverez des vues éclatées ainsi que des informations concernant les pièces de rechange également sous :

www.bosch-pt.com

Les conseillers techniques Bosch sont à votre disposition pour répondre à vos questions concernant l'achat, l'utilisation et le réglage de vos produits et leurs accessoires.

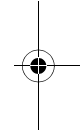
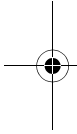

France

Robert Bosch (France) S.A.S.
Service Après-Vente Electroportatif
126, rue de Stalingrad
93705 DRANCY Cédex
Tel. : +33 (0143) 11 90 06
Fax : +33 (0143) 11 90 33
E-Mail :
sav.outillage-electroportatif@fr.bosch.com
N° Vert : +33 (0800) 05 50 51
www.bosch.fr

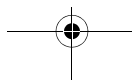

**Belgique, Luxembourg**

Tel. : +32 (070) 22 55 65

Fax : +32 (070) 22 55 75

E-Mail : outillage.gereedschap@be.bosch.com

Suisse

Tel. : +41 (044) 8 47 15 12

Fax : +41 (044) 8 47 15 52

Transport

L'accu a été testé suivant le manuel de l'ONU ST/SG/AC.10/11/Rév.3 partie III, chapitre 38.3. Il est doté d'une protection effective contre une surpression intérieure et les courts-circuits ainsi que de dispositifs empêchant toute destruction par la force et un courant de retour dangereux.

La quantité d'équivalent de lithium se trouvant dans l'accu est inférieure aux valeurs limites correspondantes. En tant que pièce détachée ou intégrée dans un appareil, un accu n'est donc pas soumis aux prescriptions concernant les transports de matériaux dangereux. Cependant ces prescriptions peuvent s'appliquer au transport de plusieurs accus. Dans un tel cas, il peut s'avérer nécessaire de respecter certaines conditions particulières, par ex. pour l'emballage). Pour des informations supplémentaires, consulter la fiche technique en langue anglaise sous : <http://purchasing.bosch.com/en/start/Allgemeines/Download/index.htm>.

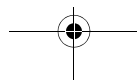
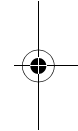
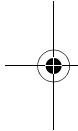

Élimination des déchets

Les outils électroportatifs, ainsi que leurs accessoires et emballages, doivent pouvoir suivre chacun une voie de recyclage appropriée.

Seulement pour les pays de l'Union Européenne :



Ne jetez pas votre appareil électroportatif avec les ordures ménagères ! Conformément à la directive européenne 2002/96/CE relative aux déchets d'équipements électriques et électroniques et sa réalisation dans les lois nationales, les

outils électroportatifs dont on ne peut plus se servir doivent être séparés et suivre une voie de recyclage appropriée.

Accus/piles :

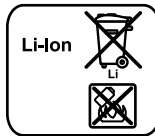

Ion lithium :

Veillez respecter les indications données dans le chapitre « Transport », page 63.

Ne pas jeter les accu/piles dans les ordures ménagères, ni dans les flammes ou l'eau. Les accu/piles doivent être collectés, recyclés ou éliminés en conformité avec les réglementations se rapportant à l'environnement.



Seulement pour les pays de l'Union Européenne :

Les accus/piles usés ou défectueux doivent être recyclés conformément à la directive 91/157/CEE.

Les accus/piles dont on ne peut plus se servir peuvent être déposés directement auprès de :

Suisse

Batrec AG
3752 Wimmis BE

Pour sortir l'accu de l'outil électroportatif, appuyer sur l'interrupteur Marche/Arrêt **8** jusqu'à ce que l'accu soit complètement déchargé. Desserrer les vis du carter et enlever la coque du carter. Débrancher les connexion sur l'accu et enlever celui-ci.

Sous réserve de modifications.

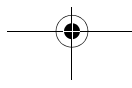
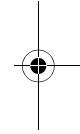
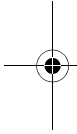

Instrucciones de seguridad

Advertencias de peligro generales para herramientas eléctricas

⚠ ADVERTENCIA Lea íntegramente estas advertencias de peligro e instrucciones. En caso de no atenerse a las advertencias de peligro e instrucciones siguientes, ello puede ocasionar una descarga eléctrica, un incendio y/o lesión grave.

Guardar todas las advertencias de peligro e instrucciones para futuras consultas.

El término herramienta eléctrica empleado en las siguientes advertencias de peligro se refiere a herramientas eléctricas de conexión a la red (con cable de red) y a herramientas eléctricas accionadas por acumulador (o sea, sin cable de red).

1) Seguridad del puesto de trabajo

- a) **Mantenga limpio y bien iluminado su puesto de trabajo.** El desorden o una iluminación deficiente en las áreas de trabajo pueden provocar accidentes.
- b) **No utilice la herramienta eléctrica en un entorno con peligro de explosión, en el que se encuentren combustibles líquidos, gases o material en polvo.** Las herramientas eléctricas producen chispas que pueden llegar a inflamar los materiales en polvo o vapores.
- c) **Mantenga alejados a los niños y otras personas de su puesto de trabajo al emplear la herramienta eléctrica.** Una distracción le puede hacer perder el control sobre la herramienta eléctrica.



2) Seguridad eléctrica

- a) **El enchufe de la herramienta eléctrica debe corresponder a la toma de corriente utilizada. No es admisible modificar el enchufe en forma alguna. No emplear adaptadores en herramientas eléctricas dotadas con una toma de tierra.** Los enchufes sin modificar adecuados a las respectivas tomas de corriente reducen el riesgo de una descarga eléctrica.
- b) **Evite que su cuerpo toque partes conectadas a tierra como tuberías, radiadores, cocinas y refrigeradores.** El riesgo a quedar expuesto a una sacudida eléctrica es mayor si su cuerpo tiene contacto con tierra.
- c) **No exponga la herramienta eléctrica a la lluvia y evite que penetren líquidos en su interior.** Existe el peligro de recibir una descarga eléctrica si penetran ciertos líquidos en la herramienta eléctrica.
- d) **No utilice el cable de red para transportar o colgar la herramienta eléctrica, ni tire de él para sacar el enchufe de la toma de corriente. Mantenga el cable de red alejado del calor, aceite, esquinas cortantes o piezas móviles.** Los cables de red dañados o enredados pueden provocar una descarga eléctrica.
- e) **Al trabajar con la herramienta eléctrica a la intemperie utilice solamente cables de prolongación apropiados para su uso en exteriores.** La utilización de un cable de prolongación adecuado para su uso en exteriores reduce el riesgo de una descarga eléctrica.

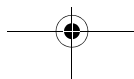
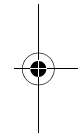
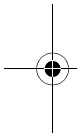



f) Si fuese imprescindible utilizar la herramienta eléctrica en un entorno húmedo, es necesario conectarla a través de un fusible diferencial. La aplicación de un fusible diferencial reduce el riesgo a exponerse a una descarga eléctrica.

3) Seguridad de personas

a) Esté atento a lo que hace y emplee la herramienta eléctrica con prudencia. No utilice la herramienta eléctrica si estuviese cansado, ni tampoco después de haber consumido alcohol, drogas o medicamentos. El no estar atento durante el uso de la herramienta eléctrica puede provocarle serias lesiones.

b) Utilice un equipo de protección personal y en todo caso unas gafas de protección. El riesgo a lesionarse se reduce considerablemente si, dependiendo del tipo y la aplicación de la herramienta eléctrica empleada, se utiliza un equipo de protección adecuado como una mascarilla antipolvo, zapatos de seguridad con suela antideslizante, casco, o protectores auditivos.

c) Evite una puesta en marcha fortuita. Asegurarse de que la herramienta eléctrica esté desconectada antes de conectarla a la toma de corriente y/o al montar el acumulador, al recogerla, y al transportarla. Si transporta la herramienta eléctrica sujetándola por el interruptor de conexión/desconexión, o si introduce el enchufe en la toma de corriente con la herramienta eléctrica conectada, ello puede dar lugar a un accidente.

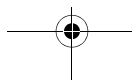
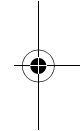
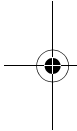



d) Retire las herramientas de ajuste o llaves fijas antes de conectar la herramienta eléctrica. Una herramienta de ajuste o llave fija colocada en una pieza rotante puede producir lesiones al poner a funcionar la herramienta eléctrica.

e) Evite posturas arriesgadas. Trabaje sobre una base firme y mantenga el equilibrio en todo momento. Ello le permitirá controlar mejor la herramienta eléctrica en caso de presentarse una situación inesperada.

f) Lleve puesta una vestimenta de trabajo adecuada. No utilice vestimenta amplia ni joyas. Mantenga su pelo, vestimenta y guantes alejados de las piezas móviles. La vestimenta suelta, el pelo largo y las joyas se pueden enganchar con las piezas en movimiento.

g) Siempre que sea posible utilizar unos equipos de aspiración o captación de polvo, asegúrese que éstos estén montados y que sean utilizados correctamente. El empleo de estos equipos reduce los riesgos derivados del polvo.

4) Uso y trato cuidadoso de herramientas eléctricas

a) No sobrecargue la herramienta eléctrica. Use la herramienta eléctrica prevista para el trabajo a realizar. Con la herramienta adecuada podrá trabajar mejor y más seguro dentro del margen de potencia indicado.

b) No utilice herramientas eléctricas con un interruptor defectuoso. Las herramientas eléctricas que no se puedan conectar o desconectar son peligrosas y deben hacerse reparar.

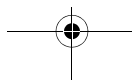
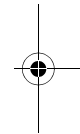
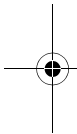

c) Saque el enchufe de la red y/o desmonte el acumulador antes de realizar un ajuste en la herramienta eléctrica, cambiar de accesorio o al guardar la herramienta eléctrica. Esta medida preventiva reduce el riesgo a conectar accidentalmente la herramienta eléctrica.

d) Guarde las herramientas eléctricas fuera del alcance de los niños. No permita la utilización de la herramienta eléctrica a aquellas personas que no estén familiarizadas con su uso o que no hayan leído estas instrucciones. Las herramientas eléctricas utilizadas por personas inexpertas son peligrosas.

e) Cuide la herramienta eléctrica con esmero. Controle si funcionan correctamente, sin atascarse, las partes móviles de la herramienta eléctrica, y si existen partes rotas o deterioradas que pudieran afectar al funcionamiento de la herramienta eléctrica. Haga reparar estas piezas defectuosas antes de volver a utilizar la herramienta eléctrica. Muchos de los accidentes se deben a herramientas eléctricas con un mantenimiento deficiente.

f) Mantenga los útiles limpios y afilados. Los útiles mantenidos correctamente se dejan guiar y controlar mejor.

g) Utilice la herramienta eléctrica, accesorios, útiles, etc. de acuerdo a estas instrucciones, considerando en ello las condiciones de trabajo y la tarea a realizar. El uso de herramientas eléctricas para trabajos diferentes de aquellos para los que han sido concebidas puede resultar peligroso.

5) Trato y uso cuidadoso de herramientas accionadas por acumulador

- a) **Solamente cargar los acumuladores con los cargadores recomendados por el fabricante.** Existe riesgo de incendio al intentar cargar acumuladores de un tipo diferente al previsto para el cargador.
- b) **Solamente emplee los acumuladores previstos para la herramienta eléctrica.** El uso de otro tipo de acumuladores puede provocar daños e incluso un incendio.
- c) **Si no utiliza el acumulador, guárdelo separado de clips, monedas, llaves, clavos, tornillos o demás objetos metálicos que pudieran puentear sus contactos.** El cortocircuito de los contactos del acumulador puede causar quemaduras o un incendio.
- d) **La utilización inadecuada del acumulador puede provocar fugas de líquido. Evite el contacto con él. En caso de un contacto accidental enjuagar el área afectada con abundante agua. En caso de un contacto con los ojos recurra además inmediatamente a un médico.** El líquido del acumulador puede irritar la piel o producir quemaduras.

6) Servicio

- a) **Únicamente haga reparar su herramienta eléctrica por un profesional, empleando exclusivamente piezas de repuesto originales.** Solamente así se mantiene la seguridad de la herramienta eléctrica.

Instrucciones de seguridad para atornilladoras

- ▶ **Sujete la herramienta eléctrica por las superficies de agarre aisladas al realizar trabajos en los que el tornillo pueda llegar a tocar conductores eléctricos ocultos.** El contacto del tornillo con conductores bajo tensión puede hacer que las partes metálicas de la herramienta eléctrica le provoquen una descarga eléctrica.
- ▶ **Sujete firmemente la herramienta eléctrica.** Al apretar o aflojar tornillos pueden presentarse bruscamente unos elevados pares de reacción.
- ▶ **Asegure la pieza de trabajo.** Una pieza de trabajo fijada con unos dispositivos de sujeción, o en un tornillo de banco, se mantiene sujeta de forma mucho más segura que con la mano.
- ▶ **Antes de cualquier manipulación en la herramienta eléctrica (p.ej. en su mantenimiento, cambio de útil, etc.), así como al transportarla o guardarla, colocar en posición central el selector de sentido de giro.** Vd. podría accidentarse en caso de un accionamiento fortuito del interruptor de conexión/desconexión.
- ▶ **Evite una puesta en marcha fortuita. Antes de montar el acumulador, asegúrese primero de que esté desconectado el interruptor de conexión/desconexión aparato.** El transporte de la herramienta eléctrica, sujetándola por el gatillo del interruptor de conexión/desconexión, o la inserción del acumulador estando conectada la herramienta eléctrica, puede provocar un accidente.

- ▶ **No intente abrir el acumulador.** Podría provocar un cortocircuito.



Proteja la herramienta eléctrica del calor excesivo como, p.ej., de una exposición prolongada al sol y del fuego. Existe el riesgo de explosión.

- ▶ **Si el acumulador se daña o usa de forma inapropiada puede que éste emane vapores. Ventile con aire fresco el recinto y acuda a un médico si nota alguna molestia.** Los vapores pueden llegar a irritar las vías respiratorias.
- ▶ **Un acumulador defectuoso puede perder líquido y humedecer la piezas adyacentes. Examine las piezas afectadas.** Límpielas, o sustitúyalas si fuese necesario.

Instrucciones de seguridad para cargadores



No exponga el cargador a la lluvia ni a la humedad. La penetración de agua en el cargador aumenta el riesgo de electrocución.

- ▶ **No cargue acumuladores de otra marca.** El cargador solamente es adecuado para cargar acumuladores Bosch de iones de Li de las tensiones indicadas en los datos técnicos. En caso de no atenerse a ello podría originarse un incendio o explosión.
- ▶ **Siempre mantenga limpio el cargador.** La suciedad puede comportar un riesgo de electrocución.
- ▶ **Antes de cada utilización verificar el estado del cargador, cable y enchufe. No utilice el cargador en caso de detectar algún desperfecto. Jamás intente abrir el cargador por su propia cuenta, y solamente hágalo reparar por personal técnico cualificado empleando exclusivamente piezas de repuesto originales.** Un cargador, cable y enchufe deteriorado comportan un mayor riesgo de electrocución.



- ▶ **No utilice el cargador sobre una base fácilmente inflamable (p.ej. papel, tela, etc.) ni en un entorno inflamable.** Puesto que el cargador se calienta durante el proceso de carga existe un peligro de incendio.

Descripción del funcionamiento



Lea íntegramente estas advertencias de peligro e instrucciones. En caso de no atenerse a las advertencias de peligro e instrucciones siguientes, ello puede ocasionar una descarga eléctrica, un incendio y/o lesión grave.

Utilización reglamentaria

El aparato ha sido diseñado para apretar y aflojar tornillos.

Únicamente utilice la herramienta eléctrica si conoce y domina todas sus funciones, o si ha sido instruido al respecto.

Componentes principales

La numeración de los componentes está referida a la imagen de la herramienta eléctrica en la página ilustrada.

- 1 Punta de atornillar*
- 2 Alojamiento del útil
- 3 Anillo de ajuste para preselección del par
- 4 Indicador de sentido de giro a derechas
- 5 Indicador del estado de carga del acumulador
- 6 Indicador de sentido de giro a izquierdas
- 7 Bombilla "Power Light"
- 8 Interruptor de conexión/desconexión

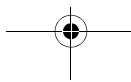

9 Selector de sentido de giro

10 Cargador

***Los accesorios descritos e ilustrados no corresponden al material que se adjunta de serie. La gama completa de accesorios opcionales se detalla en nuestro programa de accesorios.**

Datos técnicos

Atornilladora accionada por acumulador		PSR 7,2 LI
Nº de artículo		3 603 J57 7..
Tensión nominal	V=	7,2
Revoluciones en vacío	min ⁻¹	0–230
Par de giro máx. en unión atornillada rígida/blanda según ISO 5393	Nm	10/6
Ø máx. de tornillos	mm	6
Peso según EPTA-Procedure 01/2003	kg	0,5
Acumulador		iones Li
Capacidad	Ah	1,3
Nº de celdas		2
Cargador		
Nº de artículo		2 607 225 553 (EU) 2 607 225 555 (UK)
Tiempo de carga	h	5,0
Preste atención al nº de artículo en la placa de características de su aparato, ya que las denominaciones comerciales de algunos aparatos pueden variar.		



Información sobre ruidos y vibraciones

Determinación de los valores de medición según EN 60745.

El nivel de presión sonora del aparato, determinado con un filtro A, es normalmente inferior a 70 dB(A). Tolerancia K = 3 dB.

El nivel de ruido al trabajar puede sobrepasar los 80 dB(A).

¡Colocarse unos protectores auditivos!

Nivel total de vibraciones (suma vectorial de tres direcciones) determinado según EN 60745:

Atornillar: Valor de vibraciones generadas a $a_h < 2,5 \text{ m/s}^2$, tolerancia K = $1,5 \text{ m/s}^2$.

El nivel de vibraciones indicado en estas instrucciones ha sido determinado según el procedimiento de medición fijado en la norma EN 60745 y puede servir como base de comparación con otras herramientas eléctricas. También es adecuado para estimar provisionalmente la sollicitación experimentada por las vibraciones.

El nivel de vibraciones indicado ha sido determinado para las aplicaciones principales de la herramienta eléctrica. Por ello, el nivel de vibraciones puede ser diferente si la herramienta eléctrica se utiliza para otras aplicaciones, con útiles diferentes, o si el mantenimiento de la misma fuese deficiente. Ello puede suponer un aumento drástico de la sollicitación por vibraciones durante el tiempo total de trabajo.

Para determinar con exactitud la sollicitación experimentada por las vibraciones, es necesario considerar también aquellos tiempos en los que el aparato esté desconectado, o bien, esté en funcionamiento, pero sin ser utilizado realmente. Ello puede suponer una disminución drástica

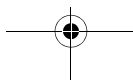
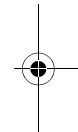
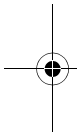



Español | 77



de la sollicitación por vibraciones durante el tiempo total de trabajo.

Fije unas medidas de seguridad adicionales para proteger al usuario de los efectos por vibraciones, como por ejemplo: Mantenimiento de la herramienta eléctrica y de los útiles, conservar calientes las manos, organización de las secuencias de trabajo.



Declaración de conformidad

Declaramos bajo nuestra responsabilidad, que el producto descrito bajo "Datos técnicos" está en conformidad con las normas o documentos normalizados siguientes: EN 60745 (aparatos accionados por acumulador), o bien EN 60335 (cargadores de acumuladores) de acuerdo con las regulaciones 2006/95/CE, 2004/108/CE, 98/37/CE (hasta el 28.12.2009), 2006/42/CE (a partir del 29.12.2009).

Expediente técnico en:
Robert Bosch GmbH, PT/ESC,
D-70745 Leinfelden-Echterdingen

 08

Dr. Egbert Schneider Senior Vice President Engineering	Dr. Eckerhard Strötgen Head of Product Certification
--	--

Robert Bosch GmbH, Power Tools Division
D-70745 Leinfelden-Echterdingen
16.09.2008



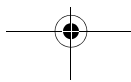
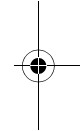
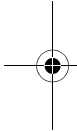

Montaje

Carga del acumulador (ver figura A)

- ▶ **No utilice un cargador diferente.** El cargador suministrado ha sido concebido exclusivamente para el acumulador de iones de litio que incorpora su herramienta eléctrica.
- ▶ **¡Preste atención a la tensión de red!** La tensión de alimentación deberá coincidir con aquella indicada en la placa de características del cargador. Los cargadores para 230 V pueden funcionar también a 220 V.

Observación: El acumulador se suministra parcialmente cargado. Con el fin de obtener la plena potencia del acumulador, antes de su primer uso, cárguelo completamente en el cargador.

El acumulador de iones de litio puede recargarse siempre que se quiera, sin que ello merme su vida útil. Una interrupción del proceso de carga no afecta al acumulador.

El acumulador de iones de litio va protegido contra altas descargas por "Electronic Cell Protection (ECP) (Protección Electrónica de Celdas)". Si el acumulador está descargado, un circuito de protección se encarga de desconectar la herramienta eléctrica. El útil deja de moverse.

⚠ ATENCIÓN En caso de una desconexión automática de la herramienta eléctrica no mantenga accionado el interruptor de conexión/desconexión. El acumulador podría dañarse.

Una vez conectado el cargador a la red, el proceso de carga comienza nada más depositar la atornilladora accionada por acumulador en el cargador **10**.

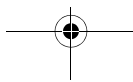
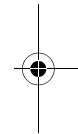
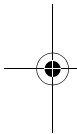

El indicador de estado de carga del acumulador **5** muestra dos situaciones de carga. Durante el proceso de carga el indicador **parpadea** de color verde. Si el acumulador está completamente cargado, el indicador se ilumina **permanentemente** de color verde.

Durante el proceso de carga es normal que se caliente la empuñadura de la herramienta eléctrica.

Desconecte el cargador de la red si prevé que no va a usarlo durante largo tiempo.

La herramienta eléctrica no puede utilizarse mientras ésta se esté cargando, y no es por lo tanto síntoma de defecto si, en este caso, no funciona.

Observe las indicaciones referentes a la eliminación.

Cambio de útil (ver figura B)

- ▶ **Antes de cualquier manipulación en la herramienta eléctrica (p.ej. en su mantenimiento, cambio de útil, etc.), así como al transportarla o guardarla, colocar en posición central el selector de sentido de giro.** Vd. podría accidentarse en caso de un accionamiento fortuito del interruptor de conexión/desconexión.
- ▶ **No utilice láminas de atornillar de doble punta con una longitud superior a 25 mm.**

Monte la punta de atornillar **1** directamente en el alojamiento del útil **2**.

Operación

Puesta en marcha

Ajuste del sentido de giro (ver figura C)

Con el selector **9** puede invertirse el sentido de giro actual de la herramienta eléctrica. Esto no es posible, sin embargo, con el interruptor de conexión/desconexión **8** accionado.

Giro a derechas: Para enroscar tornillos presione hasta el tope hacia la izquierda el selector de sentido de giro **9**.

 El indicador de sentido de giro a derechas **4** se enciende estando funcionando el motor con el interruptor de conexión/desconexión accionado **8**.

Giro a izquierdas: Para aflojar y desenroscar tornillos presionar hasta el tope hacia la derecha el selector de sentido de giro **9**.

 El indicador de sentido de giro a izquierdas **6** se enciende estando funcionando el motor con el interruptor de conexión/desconexión accionado **8**.

Preselección del par de giro

Con el anillo de ajuste para la preselección del par **3** puede Ud. preseleccionar el par de giro precisado en 10 etapas diferentes. En el momento de alcanzarse el par ajustado se detiene el útil.

Etapas 1:

Par de giro reducido para enroscar tornillos de pequeño diámetro o para enroscar en materiales blandos.

Etapas 10:

Par de giro elevado para enroscar tornillos de gran diámetro o para enroscar en materiales duros.



Conexión/desconexión

Para la **puesta en marcha** de la herramienta eléctrica accionar y mantener en esa posición el interruptor de conexión/desconexión **8**.

La bombilla **7** se enciende al presionar levemente, o del todo, el interruptor de conexión/desconexión **8**, lo cual permite iluminar el área de trabajo en lugares con poca luz.

Para **desconectar** la herramienta eléctrica soltar el interruptor de conexión/desconexión **8**.

Ajuste de las revoluciones

Variando la presión ejercida sobre el interruptor de conexión/desconexión **8** puede Ud. regular de forma continua las revoluciones de la herramienta eléctrica.

Apretando levemente el interruptor de conexión/desconexión **8** se obtienen unas revoluciones bajas. Incrementando paulatinamente la presión van aumentando las revoluciones en igual medida.

Retención automática del husillo (Auto-Lock)

El husillo, y con ello, también el alojamiento del útil, quedan retenidos siempre que no se accione el interruptor de conexión/desconexión **8**.

Esto permite enroscar tornillos a mano si el acumulador estuviese descargado o emplear la herramienta eléctrica como destornillador.

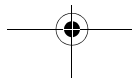
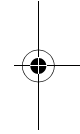
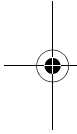



Protección contra sobrecarga térmica

La herramienta eléctrica no puede sobrecargarse si ésta se utiliza de forma reglamentaria. En caso de solicitarse excesivamente, o al superarse de temperatura admisible del acumulador de 70 °C, la herramienta eléctrica se desconecta hasta que logre alcanzar la temperatura de servicio óptima.

Protección contra altas descargas

El acumulador de iones de litio va protegido contra altas descargas por "Electronic Cell Protection (ECP) (Protección Electrónica de Celdas)". Si el acumulador está descargado, un circuito de protección se encarga de desconectar la herramienta eléctrica. El útil deja de moverse.

Instrucciones para la operación

- ▶ **Solamente aplique la herramienta eléctrica desconectada contra el tornillo.** Los útiles en rotación pueden resbalar.

Mantenimiento y servicio

Mantenimiento y limpieza

- ▶ **Antes de cualquier manipulación en la herramienta eléctrica (p.ej. en su mantenimiento, cambio de útil, etc.), así como al transportarla o guardarla, colocar en posición central el selector de sentido de giro.** Vd. podría accidentarse en caso de un accionamiento fortuito del interruptor de conexión/desconexión.
- ▶ **Mantenga limpia la herramienta eléctrica y las rejillas de refrigeración para trabajar con eficacia y seguridad.**

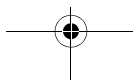



Si el acumulador fuese inservible diríjase a un servicio técnico autorizado para herramientas eléctricas Bosch.

Si a pesar de los esmerados procesos de fabricación y control, la herramienta eléctrica llegase a averiarse, la reparación deberá encargarse a un servicio técnico autorizado para herramientas eléctricas Bosch.

Para cualquier consulta o pedido de piezas de repuesto es imprescindible indicar el nº de artículo de 10 dígitos que figura en la placa de características de la herramienta eléctrica.

Servicio técnico y atención al cliente

El servicio técnico le asesorará en las consultas que pueda Ud. tener sobre la reparación y mantenimiento de su producto, así como sobre piezas de recambio. Los dibujos de despiece e informaciones sobre las piezas de recambio las podrá obtener también en internet bajo:

www.bosch-pt.com

Nuestro equipo de asesores técnicos le orientará gustosamente en cuanto a la adquisición, aplicación y ajuste de los productos y accesorios.

España

Robert Bosch España, S.A.
Departamento de ventas
Herramientas Eléctricas
C/Hermanos García Noblejas, 19
28037 Madrid
Tel. Asesoramiento al cliente: +34 (0901) 11 66 97
Fax: +34 (091) 327 98 63

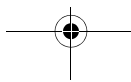
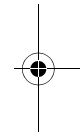
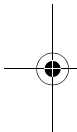



Venezuela

Robert Bosch S.A.
Final Calle Vargas. Edf. Centro Berimer P.B.
Boleita Norte
Caracas 107
Tel.: +58 (02) 207 45 11

México

Robert Bosch S.A. de C.V.
Tel. Interior: +52 (01) 800 627 1286
Tel. D.F.: +52 (01) 52 84 30 62
E-Mail: arturo.fernandez@mx.bosch.com

Argentina

Robert Bosch Argentina S.A.
Av. Córdoba 5160
C1414BAW Ciudad Autonoma de Buenos Aires
Atencion al Cliente
Tel.: +54 (0810) 555 2020
E-Mail: herramientas.bosch@ar.bosch.com

Perú

Autorex Peruana S.A.
República de Panamá 4045,
Lima 34
Tel.: +51 (01) 475-5453
E-Mail: vhe@autorex.com.pe

Chile

EMASA S.A.
Irrarázaval 259 – Ñuñoa
Santiago
Tel.: +56 (02) 520 3100
E-Mail: emasa@emasa.cl

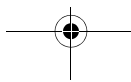
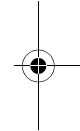
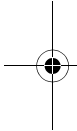

Transporte

El acumulador ha sido ensayado conforme al manual UN ST/SG/AC.10/11/Rev.3 Parte III, Subinciso 38.3. Dispone de una eficaz protección contra una sobrepresión o cortocircuito interior, así como de unos dispositivos contra la rotura forzada o corrientes inversas peligrosas.

La cantidad equivalente de litio que contiene el acumulador es inferior a los valores límite pertinentes. Es por ello, por lo que el acumulador, tanto si va suelto como si va montado en el aparato, no está sujeto a las directivas nacionales e internacionales sobre el transporte de mercancías peligrosas. Sin embargo, esto si puede ser de relevancia, si son varios los acumuladores transportados. En este caso puede que sea imperativo cumplir ciertas exigencias (p.ej. en el embalaje). Para más detalles le remitimos a la ficha técnica redactada en inglés que puede consultar en internet bajo la siguiente dirección: <http://purchasing.bosch.com/en/start/Allgemeines/Download/index.htm>.

Eliminación

Recomendamos que las herramientas eléctricas, accesorios y embalajes sean sometidos a un proceso de recuperación que respete el medio ambiente.

Sólo para los países de la UE:



¡No arroje las herramientas eléctricas a la basura!

Conforme a la Directriz Europea 2002/96/CE sobre aparatos eléctricos y electrónicos inservibles, tras su transposición en ley nacional, deberán acumularse por separado las herramientas eléctricas para ser sometidas a un reciclaje ecológico.

Acumuladores/pilas:**Iones de Litio:**

Observe las indicaciones comprendidas en el apartado “Transporte”, página 85.

No arroje los acumuladores/pilas a la basura, ni al fuego, ni al agua. Los acumuladores/pilas deberán guardarse y reciclarse o eliminarse de manera ecológica.

Sólo para los países de la UE:

Conforme a la directriz 91/157/CEE deberán reciclarse los acumuladores/pilas defectuosos o agotados.

Los acumuladores/pilas agotados pueden entregarse directamente a su distribuidor habitual de Bosch:

España

Servicio Central de Bosch
Servilotec, S.L.
Polig. Ind. II, 27
Cabanillas del Campo
Tel.: +34 9 01 11 66 97

Para desmontar el acumulador de la herramienta eléctrica, mantenga accionado el interruptor de conexión/desconexión **8**, hasta que se haya descargado completamente el acumulador. Afloje los tornillos de la carcasa y desmonte la semicarcasa. Corte los cables de conexión y saque el acumulador.

Reservado el derecho de modificación.



Indicações de segurança

Indicações gerais de advertência para ferramentas eléctricas

⚠ ATENÇÃO Devem ser lidas todas as indicações de advertência e todas as instruções. O desrespeito das advertências e instruções apresentadas abaixo pode causar choque eléctrico, incêndio e/ou graves lesões.

Guarde bem todas as advertências e instruções para futura referência.

O termo “Ferramenta eléctrica” utilizado a seguir nas indicações de advertência, refere-se a ferramentas eléctricas operadas com corrente de rede (com cabo de rede) e a ferramentas eléctricas operadas com acumulador (sem cabo de rede).

1) Segurança da área de trabalho

- a) **Mantenha a sua área de trabalho sempre limpa e bem iluminada.** Desordem ou áreas de trabalho insuficientemente iluminadas podem levar a acidentes.
- b) **Não trabalhar com a ferramenta eléctrica em áreas com risco de explosão, nas quais se encontrem líquidos, gases ou pós inflamáveis.** Ferramentas eléctricas produzem faíscas, que podem inflamar pós ou vapores.
- c) **Manter crianças e outras pessoas afastadas da ferramenta eléctrica durante a utilização.** No caso de distração é possível que perca o controlo sobre o aparelho.

2) Segurança eléctrica

- a) A ficha de conexão da ferramenta eléctrica deve caber na tomada. A ficha não deve ser modificada de maneira alguma. Não utilizar uma ficha de adaptação junto com ferramentas eléctricas protegidas por ligação à terra.** Fichas não modificadas e tomadas apropriadas reduzem o risco de um choque eléctrico.
- b) Evitar que o corpo possa entrar em contacto com superfícies ligadas à terra, como tubos, aquecimentos, fogões e frigoríficos.** Há um risco elevado devido a choque eléctrico, se o corpo estiver ligado à terra.
- c) Manter o aparelho afastado de chuva ou humidade.** A infiltração de água numa ferramenta eléctrica aumenta o risco de choque eléctrico.
- d) Não deverá utilizar o cabo para outras finalidades. Jamais utilizar o cabo para transportar a ferramenta eléctrica, para pendurá-la, nem para puxar a ficha da tomada. Manter o cabo afastado de calor, óleo, cantos afiados ou partes do aparelho em movimento.** Cabos danificados ou emaranhados aumentam o risco de um choque eléctrico.
- e) Se trabalhar com uma ferramenta eléctrica ao ar livre, só deverá utilizar cabos de extensão apropriados para áreas exteriores.** A utilização de um cabo de extensão apropriado para áreas exteriores reduz o risco de um choque eléctrico.

f) Se não for possível evitar o funcionamento da ferramenta eléctrica em áreas húmidas, deverá ser utilizado um disjuntor de corrente de avaria. A utilização de um disjuntor de corrente de avaria reduz o risco de um choque eléctrico.

3) Segurança de pessoas

a) Esteja atento, observe o que está a fazer e tenha prudência ao trabalhar com a ferramenta eléctrica. Não utilizar uma ferramenta eléctrica quando estiver fatigado ou sob a influência de drogas, álcool ou medicamentos. Um momento de descuido ao utilizar a ferramenta eléctrica, pode levar a lesões graves.

b) Utilizar equipamento de protecção pessoal e sempre óculos de protecção. A utilização de equipamento de protecção pessoal, como máscara de protecção contra pó, sapatos de segurança antiderrapantes, capacete de segurança ou protecção auricular, de acordo com o tipo e aplicação da ferramenta eléctrica, reduz o risco de lesões.

c) Evitar uma colocação em funcionamento involuntária. Assegure-se de que a ferramenta eléctrica esteja desligada, antes de conectá-la à alimentação de rede e/ou ao acumulador, antes de levantá-la ou de transportá-la. Se tiver o dedo no interruptor ao transportar a ferramenta eléctrica ou se o aparelho for conectado à alimentação de rede enquanto estiver ligado, poderão ocorrer acidentes.

d) Remover ferramentas de ajuste ou chaves de boca antes de ligar a ferramenta eléctrica. Uma ferramenta ou chave que se encontre numa parte do aparelho em movimento pode levar a lesões.

90 | Português

- e) **Evite uma posição anormal. Mantenha uma posição firme e mantenha sempre o equilíbrio.** Desta forma é mais fácil controlar a ferramenta eléctrica em situações inesperadas.
- f) **Usar roupa apropriada. Não usar roupa larga nem jóias. Mantenha os cabelos, roupas e luvas afastadas de partes em movimento.** Roupas frouxas, cabelos longos ou jóias podem ser agarrados por peças em movimento.
- g) **Se for possível montar dispositivos de aspiração ou de recolha, assegure-se de que estejam conectados e utilizados correctamente.** A utilização de uma aspiração de pó pode reduzir o perigo devido ao pó.

4) Utilização e manuseio cuidadoso de ferramentas eléctricas

- a) **Não sobrecarregue o aparelho. Utilize a ferramenta eléctrica apropriada para o seu trabalho.** É melhor e mais seguro trabalhar com a ferramenta eléctrica apropriada na área de potência indicada.
- b) **Não utilizar uma ferramenta eléctrica com um interruptor defeituoso.** Uma ferramenta eléctrica que não pode mais ser ligada nem desligada, é perigosa e deve ser reparada.
- c) **Puxar a ficha da tomada e/ou remover o acumulador antes de executar ajustes no aparelho, de substituir acessórios ou de guardar o aparelho.** Esta medida de segurança evita o arranque involuntário da ferramenta eléctrica.



d) Guardar ferramentas eléctricas não utilizadas fora do alcance de crianças. Não permita que pessoas que não estejam familiarizadas com o aparelho ou que não tenham lido estas instruções, utilizem o aparelho. Ferramentas eléctricas são perigosas se forem utilizadas por pessoas inexperientes.

e) Tratar a ferramenta eléctrica com cuidado. Controlar se as partes móveis do aparelho funcionam perfeitamente e não emperram, e se há peças quebradas ou danificadas que possam prejudicar o funcionamento da ferramenta eléctrica. Permitir que peças danificadas sejam reparadas antes da utilização. Muitos acidentes têm como causa, a manutenção insuficiente de ferramentas eléctricas.

f) Manter as ferramentas de corte afiadas e limpas. Ferramentas de corte cuidadosamente tratadas e com cantos de corte afiados emperram com menos frequência e podem ser conduzidas com maior facilidade.

g) Utilizar a ferramenta eléctrica, acessórios, ferramentas de aplicação, etc. conforme estas instruções. Considerar as condições de trabalho e a tarefa a ser executada. A utilização de ferramentas eléctricas para outras tarefas a não ser as aplicações previstas, pode levar a situações perigosas.

5) Manuseio e utilização cuidadosos de ferramentas com acumuladores

a) Só carregar acumuladores em carregadores recomendados pelo fabricante. Há perigo de incêndio se um carregador apropriado para um certo tipo de acumuladores for utilizado para carregar acumuladores de outros tipos.

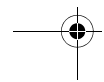
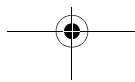
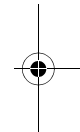
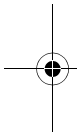

92 | Português

b) Só utilizar ferramentas eléctricas com os acumuladores apropriados. A utilização de outros acumuladores pode levar a lesões e perigo de incêndio.

c) Manter o acumulador que não está sendo utilizado afastado de cliques, moedas, chaves, parafusos ou outros pequenos objectos metálicos que possam causar um curto-circuito dos contactos. Um curto-circuito entre os contactos do acumulador pode ter como consequência queimaduras ou fogo.

d) No caso de aplicação incorrecta pode vaziar líquido do acumulador. Evitar o contacto. No caso de um contacto accidental, deverá enxaguar com água. Se o líquido entrar em contacto com os olhos, também deverá consultar um médico. Líquido que escapa do acumulador pode levar a irritações da pele ou a queimaduras.

6) Serviço

a) Só permita que o seu aparelho seja reparado por pessoal especializado e qualificado e só com peças de reposição originais. Desta forma é assegurado o funcionamento seguro do aparelho.

Indicações de segurança para aparafusadoras

- ▶ **Ao executar trabalhos durante os quais possam ser atingidos cabos eléctricos, deverá sempre segurar a ferramenta eléctrica pelas superfícies isoladas do punho.** O contacto com um cabo sob tensão também pode colocar sob tensão as peças metálicas da ferramenta eléctrica e levar a um choque eléctrico.

- ▶ **Segurar a ferramenta eléctrica com firmeza.** Ao apertar ou soltar parafusos podem ocorrer, por instantes, altos momentos de reacção.
- ▶ **Fixar a peça a ser trabalhada.** Uma peça a ser trabalhada fixa com dispositivos de aperto ou com torno de bancada está mais firme do que segurada com a mão.
- ▶ **Colocar o comutador do sentido de rotação na posição central antes de todos os trabalhos na ferramenta eléctrica (p. ex. manutenção, troca de ferramenta etc.), assim como o para o transporte e arrecadação.** Há perigo de lesões se o interruptor de ligar-desligar for accionado involuntariamente.
- ▶ **Evitar que o aparelho seja ligado sem querer. Assegure-se de que o interruptor de ligar-desligar esteja na posição desligada, antes de colocar um acumulador.** Não deverá transportar a ferramenta eléctrica com o seu dedo sobre o interruptor de ligar-desligar nem colocar o acumulador na ferramenta eléctrica ligada, pois isto poderá causar acidentes.
- ▶ **Não abrir o acumulador.** Há risco de um curto-circuito.
 **Proteger a ferramenta eléctrica contra calor, p.ex. também contra uma permanente radiação solar, e fogo.** Há risco de explosão.
- ▶ **Em caso de danos e de utilização incorrecta do acumulador, podem escapar vapores. Arejar bem o local de trabalho e consultar um médico se forem constatados quaisquer sintomas.** É possível que os vapores irrite as vias respiratórias.

- ▶ **Se o acumulador estiver com defeito, o fluido poderá escorrer e danificar as peças adjacentes. Controlar as peças em questão.** Estas peças devem ser limpas e se necessário substituídas.

Indicações de segurança para carregadores



Manter o carregador afastado de chuva ou humidade. A infiltração de água num carregador aumenta o risco de choque eléctrico.

- ▶ **Não carregar acumuladores de outras marcas.** O carregador só é apropriado para carregar acumuladores Bosch de íões de lítio com as tensões indicadas nos dados técnicos. Caso contrário, há risco de incêndio e explosão.
- ▶ **Manter o carregador limpo.** Há risco de choque eléctrico devido a sujidade.
- ▶ **Antes de cada utilização é necessário verificar o carregador, o cabo e a ficha. Não utilizar o carregador se forem verificados danos. Não abrir pessoalmente o carregador e só permita que seja reparado por pessoal qualificado e que só sejam utilizadas peças sobressalentes originais.** Carregadores, cabos e fichas danificados aumentam o risco de um choque eléctrico.
- ▶ **Não operar o carregador sobre uma base facilmente inflamável (p. ex. papel, tecidos etc.) ou em ambiente combustível.** Há perigo de incêndio devido ao aquecimento do carregador durante o carregamento.

Descrição de funções



Devem ser lidas todas as indicações de advertência e todas as instruções. O desrespeito das advertências e instruções apresentadas abaixo pode causar choque eléctrico, incêndio e/ou graves lesões.

Utilização conforme as disposições

O aparelho é destinado para apertar e soltar parafusos. Só utilizar a ferramenta eléctrica se puder avaliar exactamente todas as funções e se for capaz de exetá-las sem limitações ou se tiver sido respectivamente instruído.

Componentes ilustrados

A numeração dos componentes ilustrados refere-se à apresentação da ferramenta eléctrica na página de esquemas.

- 1 Bit de aparafusamento*
- 2 Fixação da ferramenta
- 3 Anel de pré-selecção do binário
- 4 Indicação do sentido de rotação à direita
- 5 Indicação do estado de carga do acumulador
- 6 Indicação do sentido de rotação à esquerda
- 7 Lâmpada "Power Light"
- 8 Interruptor de ligar-desligar
- 9 Comutador do sentido de rotação
- 10 Carregador

***Acessórios apresentados ou descritos não pertencem ao volume de fornecimento padrão. Todos os acessórios encontram-se no nosso programa de acessórios.**

96 | Português

Dados técnicos

Aparafusadora sem fio		PSR 7,2 LI
Nº do produto		3 603 J57 7..
Tensão nominal	V=	7,2
Nº de rotações em ponto morto	min ⁻¹	0-230
Máx. binário de aparafusamento duro/macio conforme ISO 5393	Nm	10/6
máx. Ø de aparafusamento	mm	6
Peso conforme EPTA-Procedure 01/2003	kg	0,5
Acumulador		Li-Iões
Capacidade	Ah	1,3
Número de elementos de acumulador		2
Carregador		
Nº do produto		2 607 225 553 (EU) 2 607 225 555 (UK)
Tempo de carga	h	5,0

Observar o número de produto na placa de características da sua ferramenta eléctrica. A designação comercial das ferramentas eléctricas individuais pode variar.

Informação sobre ruídos/vibrações

Valores de medição averiguados conforme EN 60745.

O nível de pressão acústica avaliado como A do aparelho é tipicamente inferior a 70 dB(A). Incerteza K = 3 dB.

O nível de ruído durante o trabalho pode ultrapassar 80 dB(A).

Usar um protector auricular!

Valores totais de vibração (soma dos vectores das três direcções) determinadas conforme EN 60745:

Parafusos: Valor de emissão de vibrações

$a_h < 2,5 \text{ m/s}^2$, incerteza K = 1,5 m/s^2 .

O nível de oscilações indicado nestas instruções de serviço foi medido de acordo com um processo de medição normalizado pela norma EN 60745 e pode ser utilizado para a comparação de aparelhos. Ele também é apropriado para uma avaliação provisória da carga de vibrações. O nível de vibrações indicado representa as aplicações principais da ferramenta eléctrica. Se a ferramenta eléctrica for utilizada para outras aplicações, com outras ferramentas de trabalho ou com manutenção insuficiente, é possível que o nível de vibrações seja diferente. Isto pode aumentar sensivelmente a carga de vibrações para o período completo de trabalho.

Para uma estimacção exacta da carga de vibrações, também deveriam ser considerados os períodos nos quais o aparelho está desligado ou funciona, mas não está sendo utilizado. Isto pode reduzir a carga de vibrações durante o completo período de trabalho.



98 | Português



Além disso também deverão ser estipuladas medidas de segurança para proteger o operador contra o efeito de vibrações, como por exemplo: Manutenção de ferramentas eléctricas e de ferramentas de trabalho, manter as mãos quentes e organização dos processos de trabalho.



Declaração de conformidade

Declaramos sob nossa exclusiva responsabilidade que o produto descrito em “Dados técnicos” cumpre as seguintes normas ou documentos normativos: EN 60745 (aparelhos com acumuladores) ou EN 60335 (carregadores de acumuladores) conforme as disposições das directivas 2006/95/CE, 2004/108/CE, 98/37/CE (até 28.12.2009), 2006/42/CE (a partir de 29.12.2009).

Processo técnico em:
Robert Bosch GmbH, PT/ESC,
D-70745 Leinfelden-Echterdingen

 08

Dr. Egbert Schneider	Dr. Eckerhard Strötgen
Senior Vice President	Head of Product
Engineering	Certification

Robert Bosch GmbH, Power Tools Division
D-70745 Leinfelden-Echterdingen
16.09.2008

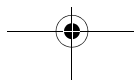

Montagem

Carregar o acumulador (veja figura A)

- ▶ **Não utilizar outro carregador.** O carregador fornecido está adaptado ao acumulador de Li-íões montado na sua ferramenta eléctrica.
- ▶ **Observar a tensão de rede!** A tensão da fonte de corrente deve coincidir com a chapa de identificação do carregador. Carregadores marcados para 230 V também podem ser operados com 220 V.

Nota: O acumulador é fornecido parcialmente carregado. Para assegurar a completa potência do acumulador, o acumulador deverá ser carregado completamente no carregador antes da primeira utilização.

O acumulador de íões de lítio pode ser carregado a qualquer altura, sem que a sua vida útil seja reduzida. Uma interrupção do processo de carga não danifica o acumulador.

O acumulador de íões de lítio está protegido por “Electronic Cell Protection (ECP)” contra descarga total. A ferramenta eléctrica é desligada através de um disjuntor de protecção, logo que o acumulador estiver descarregado. A ferramenta de trabalho não se movimenta mais.

⚠ ATENÇÃO Não continuar a premir o interruptor de ligar-desligar após o desligamento automático da ferramenta eléctrica. O acumulador pode ser danificado.

O processo de carga começa assim que introduzir a ficha de rede do carregador na tomada e colocar a aparafusadora sem fio sobre o carregador **10**.

100 | Português

A indicação do estado de carga do acumulador **5** indica o progresso de carga. Durante o processo de carga a indicação **pisca** verde. O acumulador está completamente carregado, se a indicação verde estiver **permanentemente** acesa.

O punho da ferramenta eléctrica aquece-se durante o processo de carga. Isto é normal.

Separar o carregador da rede eléctrica se não for utilizado por muito tempo.

A ferramenta eléctrica não pode ser utilizada durante o processo de carga; ela não está com defeito se não funcionar durante o processo de carga.

Observar a indicação sobre a eliminação de forma ecológica.

Troca de ferramenta (veja figura B)

- **Colocar o comutador do sentido de rotação na posição central antes de todos os trabalhos na ferramenta eléctrica (p. ex. manutenção, troca de ferramenta etc.), assim como o para o transporte e arrecadação.**

Há perigo de lesões se o interruptor de ligar-desligar for accionado involuntariamente.

- **Não utilizar pontas de aparafusar duplas com um comprimento superior a 25 mm.**

Colocar a ponta de aparafusar **1** directamente no encabudo da ferramenta **2**.

Funcionamento

Colocação em funcionamento

Ajustar o sentido de rotação (veja figura C)

Com o comutador de sentido de rotação **9** é possível alterar o sentido de rotação da ferramenta eléctrica. Com o interruptor de ligar-desligar pressionado **8** isto no entanto não é possível.

Rotação à direita: Premir o comutador do sentido de rotação **9** completamente para a esquerda, para atarraxar parafusos.

 A indicação do sentido de rotação à direita **4** ilumina-se quando o interruptor de ligar-desligar **8** está premido e quando o motor está em funcionamento.

Marcha à esquerda: Premir o comutador do sentido de rotação completamente para a direita **9** para soltar ou desatarraxar parafusos.

 A indicação do sentido de rotação à esquerda **6** ilumina-se quando o interruptor de ligar-desligar **8** está premido e quando o motor está em funcionamento.

Pré-seleccionar o binário

Com o anel de pré-selecção do binário **3** é possível pré-seleccionar, com escalonamento, o binário necessário **10**. A ferramenta de trabalho é parada assim que o binário ajustado for alcançado.

102 | Português**Nível 1:**

Pequeno binário para atarraxar parafusos com pequeno diâmetro ou em materiais macios.

Nível 10:

Maior binário para atarraxar parafusos com maior diâmetro ou em materiais duros.

Ligar e desligar

Para a **colocação em funcionamento** da ferramenta eléctrica deverá pressionar o interruptor de ligar-desligar **8** e manter pressionado.

A lâmpada **7** ilumina-se quando o interruptor de ligar-desligar **8** está parcialmente ou completamente premido e ilumina o local de trabalho se a luz ambiente não for suficiente.

Para **desligar** a ferramenta eléctrica, deverá soltar novamente o interruptor de ligar-desligar **8**.

Ajustar o número de rotações

O número de rotações da ferramenta eléctrica ligada pode ser regulada sem escalonamento, dependendo de quanto premir o interruptor de ligar-desligar **8**.

Uma leve pressão sobre o interruptor de ligar-desligar **8** proporciona um número de rotações baixo. Aumentando a pressão, é aumentado o nº de rotações.

Bloqueio automático do veio (Auto-Lock)

Sempre que o interruptor de ligar-desligar **8** não estiver premido, a árvore porta-brocas e portanto a admissão da ferramenta está travada.

Desta forma é possível apertar parafusos até mesmo com o acumulador descarregado ou utilizar a ferramenta eléctrica como chave de fendas.

Protecção contra sobrecarga em dependência da temperatura

A ferramenta eléctrica não pode ser sobrecarregada se for utilizada de acordo com as disposições. Se a carga for excessiva ou se a temperatura do acumulador ultrapassar os admissíveis 70 °C, a electrónica desligará a ferramenta eléctrica até esta retornar à faixa de temperatura de funcionamento optimizada.

Protecção contra descarga total

O acumulador de iões de lítio está protegido por “Electronic Cell Protection (ECP)” contra descarga total. A ferramenta eléctrica é desligada através de um disjuntor de protecção, logo que o acumulador estiver descarregado. A ferramenta de trabalho não se movimenta mais.

Indicações de trabalho

- ▶ **A ferramenta eléctrica só deve ser colocada sobre o parafuso quando estiver desligada.** Ferramentas de trabalho em rotação podem escorregar.

Manutenção e serviço

Manutenção e limpeza

- ▶ **Colocar o comutador do sentido de rotação na posição central antes de todos os trabalhos na ferramenta eléctrica (p. ex. manutenção, troca de ferramenta etc.), assim como o para o transporte e arrecadação.** Há perigo de lesões se o interruptor de ligar-desligar for accionado involuntariamente.

104 | Português**► Manter a ferramenta eléctrica e as aberturas de ventilação sempre limpas, para trabalhar bem e de forma segura.**

O acumulador não funciona mais; dirija-se a um serviço pós-venda autorizado para ferramentas eléctricas Bosch. Se a ferramenta eléctrica falhar apesar de cuidadosos processos de fabricação e de teste, a reparação deverá ser executada por uma oficina de serviço autorizada para ferramentas eléctricas Bosch.

Para todas as questões e encomendas de peças sobressalentes é imprescindível indicar o número de produto de 10 dígitos como consta na placa de características da ferramenta eléctrica.

Serviço pós-venda e assistência ao cliente

O serviço pós-venda responde às suas perguntas a respeito de serviços de reparação e de manutenção do seu produto, assim como das peças sobressalentes. Desenhos explodidos e informações sobre peças sobressalentes encontram-se em:

www.bosch-pt.com

A nossa equipa de consultores Bosch esclarece com prazer todas as suas dúvidas a respeito da compra, aplicação e ajuste dos produtos e acessórios.

Portugal

Robert Bosch LDA
Avenida Infante D. Henrique
Lotes 2E – 3E
1800 Lisboa
Tel.: +351 (021) 8 50 00 00
Fax: +351 (021) 8 51 10 96



Brasil

Robert Bosch Ltda.
Caixa postal 1195
13065-900 Campinas
Tel.: +55 (0800) 70 45446
E-Mail: sac@bosch-sac.com.br

Transporte

O acumulador foi testado conforme o manual UN ST/SG/AC.10/11/Rev.3 parte III, sub-capítulo 38.3. Ele é protegido contra sobre-pressão interior e contra curto-circuitos e tem dispositivos para evitar rupturas violentas e perigosas correntes de retorno.

A quantidade equivalente de lítio contida no acumulador é inferior aos respectivos valores limites. Por este motivo o acumulador, como unidade ou introduzido num aparelho, não está sujeito às leis nacionais nem internacionais para materiais perigosos. As leis para materiais perigosos podem no entanto ser relevantes para o transporte de vários acumuladores. Neste caso pode ser necessário manter certas condições especiais (p. ex. referentes à embalagem). Informações detalhadas estão disponíveis numa folha de instruções no seguinte endereço internet: <http://purchasing.bosch.com/en/start/Allgemeines/Download/index.htm>.

Eliminação

Ferramentas eléctricas, acessórios e embalagens devem ser enviados a uma reciclagem ecológica de matérias primas.

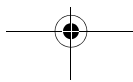
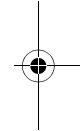
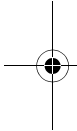

106 | Português**Apenas países da União Europeia:**

Não deitar ferramentas eléctricas no lixo doméstico!

De acordo com a directiva europeia 2002/96/CE para aparelhos eléctricos e electrónicos velhos, e com as respectivas realizações nas leis nacionais, as ferramentas eléctricas que não servem mais para a utilização, devem ser enviadas separadamente a uma reciclagem ecológica.

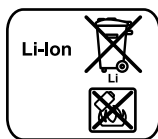
Acumuladores/pilhas:**Baterias de lítio:**

Observar as indicações no capítulo “Transporte”, Página 105.

Acumuladores/pilhas não devem ser deitados no lixo doméstico, nem no fogo nem na água. Acumuladores/pilhas devem ser recolhidos, reciclados ou eliminados de forma ecológica.

Apenas países da União Europeia:

Acumuladores e pilhas defeituosos ou gastos devem ser reciclados conforme a directiva 91/157/CEE.

Accionar o interruptor de ligar-desligar **8** para retirar o acumulador da ferramenta eléctrica, até o acumulador estar completamente descarregado. Desaparafusar os parafusos da carcaça e retirar a cápsula da carcaça. Separar as conexões no acumulador e retirar o acumulador.

Sob reserva de alterações.

Norme di sicurezza

Avvertenze generali di pericolo per elettroutensili

⚠ AVVERTENZA Leggere tutte le avvertenze di pericolo e le istruzioni operative. In caso di mancato rispetto delle avvertenze di pericolo e delle istruzioni operative si potrà creare il pericolo di scosse elettriche, incendi e/o incidenti gravi.

Conservare tutte le avvertenze di pericolo e le istruzioni operative per ogni esigenza futura.

Il termine «elettrotensile» utilizzato nelle avvertenze di pericolo si riferisce ad utensili elettrici alimentati dalla rete (con linea di allacciamento) ed ad utensili elettrici alimentati a batteria (senza linea di allacciamento).

1) Sicurezza della postazione di lavoro

- a) **Tenere la postazione di lavoro sempre pulita e ben illuminata.** Il disordine oppure zone della postazione di lavoro non illuminate possono essere causa di incidenti.
- b) **Evitare d'impiegare l'elettrotensile in ambienti soggetti al rischio di esplosioni nei quali si abbia presenza di liquidi, gas o polveri infiammabili.** Gli elettrotensili producono scintille che possono far infiammare la polvere o i gas.
- c) **Tenere lontani i bambini ed altre persone durante l'impiego dell'elettrotensile.** Eventuali distrazioni potranno comportare la perdita del controllo sull'elettrotensile.

2) Sicurezza elettrica

- a) La spina di allacciamento alla rete dell'elettro-
tensile deve essere adatta alla presa. Evitare as-
solutamente di apportare modifiche alla spina.
Non impiegare spine adattatrici assieme ad elet-
troutensili dotati di collegamento a terra.** Le spine
non modificate e le prese adatte allo scopo riducono
il rischio di scosse elettriche.
- b) Evitare il contatto fisico con superfici collegate a
terra, come tubi, riscaldamenti, cucine elettriche
e frigoriferi.** Sussiste un maggior rischio di scosse
elettriche nel momento in cui il corpo è messo a
massa.
- c) Custodire l'elettrotenso al riparo dalla pioggia
o dall'umidità.** La penetrazione dell'acqua in un
elettrotenso aumenta il rischio di una scossa
elettrica.
- d) Non usare il cavo per scopi diversi da quelli previ-
sti ed, in particolare, non usarlo per trasportare o
per appendere l'elettrotenso oppure per
estrarre la spina dalla presa di corrente. Non avvi-
cinare il cavo a fonti di calore, olio, spigoli taglien-
ti e neppure a parti della macchina che siano in
movimento.** I cavi danneggiati o aggrovigliati au-
mentano il rischio d'insorgenza di scosse elettri-
che.
- e) Qualora si voglia usare l'elettrotenso all'aperto,
impiegare solo ed esclusivamente cavi di prolun-
ga che siano adatti per l'impiego all'esterno.** L'uso
di un cavo di prolunga omologato per l'impiego
all'esterno riduce il rischio d'insorgenza di scosse
elettriche.

f) Qualora non fosse possibile evitare di utilizzare l'elettro utensile in ambiente umido, utilizzare un interruttore di sicurezza. L'uso di un interruttore di sicurezza riduce il rischio di una scossa elettrica.

3) Sicurezza delle persone

a) È importante concentrarsi su ciò che si sta facendo e maneggiare con giudizio l'elettro utensile durante le operazioni di lavoro. Non utilizzare mai l'elettro utensile in caso di stanchezza oppure quando ci si trovi sotto l'effetto di droghe, bevande alcoliche e medicinali. Un attimo di distrazione durante l'uso dell'elettro utensile può essere causa di gravi incidenti.

b) Indossare sempre equipaggiamento protettivo individuale, nonché guanti protettivi. Indossando abbigliamento di protezione personale come la maschera per polveri, scarpe di sicurezza che non scivolino, elmetto di protezione oppure protezione acustica a seconda del tipo e dell'applicazione dell'elettro utensile, si riduce il rischio di incidenti.

c) Evitare l'accensione involontaria dell'elettro utensile. Prima di collegarlo alla rete di alimentazione elettrica e/o alla batteria ricaricabile, prima di prenderlo oppure prima di iniziare a trasportarlo, assicurarsi che l'elettro utensile sia spento. Tenendo il dito sopra l'interruttore mentre si trasporta l'elettro utensile oppure collegandolo all'alimentazione di corrente con l'interruttore inserito, si vengono a creare situazioni pericolose in cui possono verificarsi seri incidenti.



d) Prima di accendere l'elettrotensile togliere gli attrezzi di regolazione o la chiave inglese. Un accessorio oppure una chiave che si trovi in una parte rotante della macchina può provocare seri incidenti.

e) Evitare una posizione anomala del corpo. Avere cura di mettersi in posizione sicura e di mantenere l'equilibrio in ogni situazione. In questo modo è possibile controllare meglio l'elettrotensile in caso di situazioni inaspettate.

f) Indossare vestiti adeguati. Non indossare vestiti larghi, né portare bracciali e catenine. Tenere i capelli, i vestiti ed i guanti lontani da pezzi in movimento. Vestiti lenti, gioielli o capelli lunghi potranno impigliarsi in pezzi in movimento.

g) In caso fosse previsto il montaggio di dispositivi di aspirazione della polvere e di raccolta, assicurarsi che gli stessi siano collegati e che vengano utilizzati correttamente. L'utilizzo di un'aspirazione polvere può ridurre lo svilupparsi di situazioni pericolose dovute alla polvere.

4) Trattamento accurato ed uso corretto degli elettrotensili

a) Non sottoporre la macchina a sovraccarico. Per il proprio lavoro, utilizzare esclusivamente l'elettrotensile esplicitamente previsto per il caso.

Con un elettrotensile adatto si lavora in modo migliore e più sicuro nell'ambito della sua potenza di prestazione.

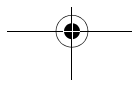
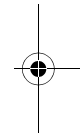
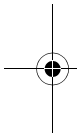

b) Non utilizzare mai elettroutensili con interruttori difettosi. Un elettroutensile con l'interruttore rotto è pericoloso e deve essere aggiustato.

c) Prima di procedere ad operazioni di regolazione sulla macchina, prima di sostituire parti accessorie oppure prima di posare la macchina al termine di un lavoro, estrarre sempre la spina dalla presa della corrente e/o estrarre la batteria ricaricabile. Tale precauzione eviterà che l'elettroutensile possa essere messo in funzione involontariamente.

d) Quando gli elettroutensili non vengono utilizzati, conservarli al di fuori del raggio di accesso di bambini. Non fare usare l'elettroutensile a persone che non siano abituate ad usarlo o che non abbiano letto le presenti istruzioni. Gli elettroutensili sono macchine pericolose quando vengono utilizzati da persone non dotate di sufficiente esperienza.

e) Eseguire la manutenzione dell'elettroutensile operando con la dovuta diligenza. Accertarsi che le parti mobili della macchina funzionino perfettamente, che non s'inzeppino e che non ci siano pezzi rotti o danneggiati al punto da limitare la funzione dell'elettroutensile stesso. Prima di iniziare l'impiego, far riparare le parti danneggiate. Numerosi incidenti vengono causati da elettroutensili la cui manutenzione è stata effettuata poco accuratamente.

f) Mantenere gli utensili da taglio sempre affilati e puliti. Gli utensili da taglio curati con particolare attenzione e con taglienti affilati s'inzeppano meno frequentemente e sono più facili da condurre.

g) Utilizzare l'elettro utensile, gli accessori opzionali, gli utensili per applicazioni specifiche ecc., sempre attenendosi alle presenti istruzioni. Così facendo, tenere sempre presente le condizioni di lavoro e le operazioni da eseguire. L'impiego di elettro utensili per usi diversi da quelli consentiti potrà dar luogo a situazioni di pericolo.

5) Trattamento ed utilizzo appropriato di utensili dotati di batterie ricaricabili

a) Caricare la batteria ricaricabile solo ed esclusivamente nei dispositivi di carica consigliati dal produttore. Per un dispositivo di carica previsto per un determinato tipo di batteria sussiste pericolo di incendio se viene utilizzato con un tipo diverso di batteria ricaricabile.

b) Avere cura d'impiegare negli elettro utensili solo ed esclusivamente batterie ricaricabili esplicitamente previste. L'uso di batterie ricaricabili di tipo diverso potrà dare insorgenza a lesioni e comportare il rischio d'incendi.

c) Non avvicinare batterie non utilizzate a fermagli, monete, chiavi, chiodi, viti e neppure ad altri piccoli oggetti metallici che potrebbero provocare un cavallottamento dei contatti. Un eventuale corto circuito tra i contatti dell'accumulatore potrà dare origine a bruciature o ad incendi.

d) In caso d'impiego errato si provoca il pericolo di fuoriuscita di liquido dalla batteria ricaricabile. Evitarne assolutamente il contatto. In caso di contatto accidentale, sciacquare accuratamente con acqua. Rivolgersi immediatamente al medico, qualora il liquido dovesse entrare in contatto con gli occhi. Il liquido fuoriuscito dalla batteria ricaricabile potrà causare irritazioni cutanee o ustioni.

6) Assistenza

- a) **Fare riparare l'elettrotensile solo ed esclusivamente da personale specializzato e solo impiegando pezzi di ricambio originali.** In tale maniera potrà essere salvaguardata la sicurezza dell'elettrotensile.

Norme di sicurezza per avvitatore

- ▶ **Tenere l'apparecchio per le superfici isolate dell'impugnatura qualora venissero effettuati lavori durante i quali la vite potrebbe venire a contatto con cavi elettrici nascosti.** Il contatto della vite con un cavo sotto tensione può mettere sotto tensione anche parti metalliche dell'apparecchio, causando una scossa elettrica.
- ▶ **Tenere sempre ben saldo l'elettrotensile.** Serrando a fondo ed allentando le viti è possibile che si verifichino temporaneamente alti momenti di reazione.
- ▶ **Assicurare il pezzo in lavorazione.** Un pezzo in lavorazione può essere bloccato con sicurezza in posizione solo utilizzando un apposito dispositivo di serraggio oppure una morsa a vite e non tenendolo con la semplice mano.
- ▶ **Prima di effettuare lavori all'elettrotensile (ad es. lavori di manutenzione, cambio d'utensile, ecc.), nonché in caso di trasporto e di conservazione dello stesso, avere sempre cura di portare in posizione media il commutatore per la reversibilità.** In difetto, sussisterà il pericolo di lesioni in caso di azionamento accidentale dell'interruttore di avvio/di arresto.

114 | Italiano

- ▶ **Evitare accensioni accidentali. Prima di inserire una batteria ricaricabile, assicurarsi che l'interruttore di avvio/arresto si trovi in posizione disinserita.** Trasportando l'elettrotrattensile tenendolo con il dito all'interruttore di avvio/arresto oppure inserendo la batteria ricaricabile quando l'elettrotrattensile è acceso si possono provocare seri incidenti.
- ▶ **Non aprire la batteria.** Vi è il pericolo di un corto circuito.



Proteggere l'elettrotrattensile dal calore, p.es. anche dall'irradiazione solare continuo e dal fuoco. Esiste pericolo di esplosione.

- ▶ **In caso di difetto e di uso improprio della batteria ricaricabile vi è il pericolo di una fuoriuscita di vapori. Far entrare aria fresca e farsi visitare da un medico in caso di disturbi.** I vapori possono irritare le vie respiratorie.
- ▶ **In caso di batterie difettose vi può essere una fuoriuscita di liquidi che possono umettare oggetti vicini. Controllare le relative parti.** Pulire queste parti e, se il caso, sostituirle.

Indicazioni di sicurezza per caricabatteria

Custodire il caricabatteria al riparo dalla pioggia o dall'umidità. L'eventuale infiltrazione di acqua in un caricabatteria va ad aumentare il rischio d'insorgenza di scosse elettriche.

- ▶ **Non caricare batterie di altra fabbricazione.** Il caricabatteria è idoneo esclusivamente per operazioni di ricarica di batterie Bosch agli ioni di litio con tensioni indicate sotto dati tecnici. In caso contrario si viene a creare il pericolo di incendio e di esplosione.
- ▶ **Avere cura di mantenere il caricabatteria sempre pulito.** Attraverso accumuli di sporcizia si crea il pericolo di una scossa elettrica.
- ▶ **Prima di ogni impiego controllare il caricabatteria, il cavo e la spina. Non utilizzare il caricabatteria in caso doveste riscontrare dei danni. Non aprire mai personalmente il caricabatteria e farlo riparare soltanto da personale qualificato e soltanto con pezzi di ricambio originali.** In caso di caricabatterie per batterie, cavi e spine danneggiate si aumenta il pericolo di una scossa elettrica.
- ▶ **Non utilizzare il caricabatteria su basi facilmente infiammabili (p. es. carta, tessuti ecc.) oppure in ambienti infiammabili.** Per via del riscaldamento del caricabatteria che si ha durante la fase di ricarica si viene a creare il pericolo di incendio.

Descrizione del funzionamento



Leggere tutte le avvertenze di pericolo e le istruzioni operative. In caso di mancato rispetto delle avvertenze di pericolo e delle istruzioni operative si potrà creare il pericolo di scosse elettriche, incendi e/o incidenti gravi.



Uso conforme alle norme

La macchina è adatta per avvitare e svitare viti.

Utilizzare l'elettrotensile esclusivamente se sono state completamente valutate tutte le funzioni e possono essere effettuate senza limitazioni oppure sono state mantenute le relative istruzioni.

Componenti illustrati

La numerazione dei componenti illustrati si riferisce all'illustrazione dell'elettrotensile che si trova sulla pagina con la rappresentazione grafica.

- 1 Bit cacciavite*
- 2 Mandrino portautensile
- 3 Anello di regolazione preselezione della coppia
- 4 Visualizzazione della direzione di marcia, rotazione destrorsa
- 5 Indicatore dello stato di carica della batteria
- 6 Visualizzazione della direzione di marcia, rotazione sinistrorsa
- 7 Illuminazione del punto di avvitatura «PowerLight»
- 8 Interruttore di avvio/arresto
- 9 Commutatore del senso di rotazione
- 10 Dispositivo di carica

***L'accessorio illustrato oppure descritto non è compreso nel volume di fornitura standard. L'accessorio completo è contenuto nel nostro programma accessori.**

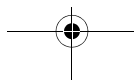
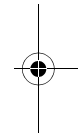
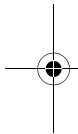

Dati tecnici

Avvitatore a batteria		PSR 7,2 LI
Codice prodotto		3 603 J57 7..
Tensione nominale	V=	7,2
Numero di giri a vuoto	min ⁻¹	0–230
Mass. momento di coppia avvitamento di giunti rigidi/elastici conforme alla norma ISO 5393	Nm	10/6
Diam. max. delle viti	mm	6
Peso in funzione della EPTA-Procedure 01/2003	kg	0,5
Batteria ricaricabile		Li-Ionen
Autonomia	Ah	1,3
Numero degli elementi della batteria ricaricabile		2
Stazione di ricarica		
Codice prodotto		2 607 225 553 (EU) 2 607 225 555 (UK)
Tempo di ricarica	h	5,0

Si prega di tenere presente il codice prodotto applicato sulla targhetta di costruzione del Vostro elettroutensile. Le descrizioni commerciali di singoli elettroutensili possono variare.



Informazioni sulla rumorosità e sulla vibrazione

Valori misurati conformemente alla norma EN 60745.

Il livello di pressione acustica stimato A della macchina ammonta ad un valore minore di 70 dB(A). Incertezza della misura $K = 3$ dB.

Il livello di rumore durante il lavoro può superare 80 dB(A).

Usare la protezione acustica!

Valori complessivi di oscillazioni (somma vettoriale in tre direzioni) misurati conformemente alla norma 60745:

Avvitamento: Valore di emissione oscillazioni $a_h < 2,5$ m/s², incertezza della misura $K = 1,5$ m/s².

Il livello di vibrazioni indicato nelle presenti istruzioni è stato rilevato seguendo una procedura di misurazione conforme alla norma EN 60745 e può essere utilizzato per confrontare gli elettrotensili. Lo stesso è idoneo anche per una valutazione temporanea della sollecitazione da vibrazioni.

Il livello di vibrazioni indicato rappresenta gli impieghi principali dell'elettrotensile. Qualora l'elettrotensile venisse utilizzato tuttavia per altri impieghi, con accessori differenti oppure con manutenzione insufficiente, il livello di vibrazioni può differire. Questo può aumentare sensibilmente la sollecitazione da vibrazioni per l'intero periodo di tempo operativo.

Per una valutazione precisa della sollecitazione da vibrazioni bisognerebbe considerare anche i tempi in cui l'apparecchio è spento oppure è acceso ma non è utilizzato effettivamente. Questo può ridurre chiaramente la sollecitazione da vibrazioni per l'intero periodo operativo.

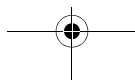
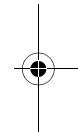
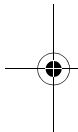

Italiano | 119

Adottare misure di sicurezza supplementari per la protezione dell'operatore dall'effetto delle vibrazioni come p. es.: manutenzione dell'elettrotensile e degli accessori, mani calde, organizzazione dello svolgimento del lavoro.



Dichiarazione di conformità

Assumendone la piena responsabilità, dichiariamo che il prodotto descritto nei «Dati tecnici» è conforme alle seguenti normative ed ai relativi documenti: EN 60745 (macchine a batteria) oppure EN 60335 (caricatori batteria) in base alle prescrizioni delle direttive 2006/95/CE, 2004/108/CE, 98/37/CE (fino al 28.12.2009), 2006/42/CE (a partire dal 29.12.2009).

Fascicolo tecnico presso:
Robert Bosch GmbH, PT/ESC,
D-70745 Leinfelden-Echterdingen

 08

Dr. Egbert Schneider	Dr. Eckerhard Strötgen
Senior Vice President	Head of Product
Engineering	Certification

Robert Bosch GmbH, Power Tools Division
D-70745 Leinfelden-Echterdingen
16.09.2008

Montaggio

Caricare la batteria (vedi figura A)

- ▶ **Non utilizzare mai un altro tipo di caricabatteria.** Il caricabatteria fornito in dotazione è adattato alla batteria ricaricabile agli ioni di litio di cui è dotato l'elettro utensile.
- ▶ **Osservare la tensione di rete!** La tensione della rete deve corrispondere a quella indicata sulla stazione di ricarica. Stazioni di ricarica previste per l'uso con 230 V possono essere azionate anche a 220 V.

Nota bene: La batteria ricaricabile viene fornita parzialmente carica. Per garantire l'intera potenza della batteria ricaricabile, prima del primo impiego ricaricare completamente la batteria ricaricabile nella stazione di ricarica.

La batteria ricaricabile a ioni di litio può essere ricaricata in qualsiasi momento senza ridurne la durata. Un'interruzione dell'operazione di ricarica non danneggia la batteria ricaricabile.

La batteria ricaricabile agli ioni di litio non è protetta dalla «Electronic Cell Protection (ECP)» contro lo scaricamento completo. In caso di batteria scarica l'elettro utensile si spegne attraverso un interruttore automatico: Il portautensile od accessorio non si muove più.

⚠ ATTENZIONE Dopo la disattivazione automatica dell'elettro utensile non continuare a premere l'interruttore di avvio/arresto. La batteria ricaricabile potrebbe subire dei danni.

L'operazione di ricarica inizia non appena si inserisce la spina della stazione di ricarica nella presa di alimentazione e si applica dunque l'avvitatore a batteria nella stazione di ricarica **10**.

L'indicatore dello stato di carica della batteria **5** indica il progresso della carica. Durante l'operazione di ricarica l'indicatore **lampeggia** verde. La batteria ricaricabile è completamente carica quando l'indicatore è illuminato **permanentemente** verde.

Durante l'operazione di ricarica l'impugnatura dell'elettrotroutensile si riscalda. Ciò è normale.

In caso di pause maggiori, si consiglia di staccare il carica-batteria dalla rete di alimentazione.

Durante l'operazione di ricarica l'elettrotroutensile non può essere utilizzato, lo stesso non è difettoso se durante l'operazione di ricarica non funziona.

Si prega di attenersi alle indicazioni relative allo smaltimento.

Cambio degli utensili (vedi figura B)

► **Prima di effettuare lavori all'elettrotroutensile (ad es. lavori di manutenzione, cambio d'utensile, ecc.), nonché in caso di trasporto e di conservazione dello stesso, avere sempre cura di portare in posizione media il commutatore per la reversibilità.** In difetto, sussisterà il pericolo di lesioni in caso di azionamento accidentale dell'interruttore di avvio/di arresto.

► **Non utilizzare lame a cacciavite (bit) bilaterali con una lunghezza di oltre 25 mm.**

Applicare il bit cacciavite **1** direttamente nel mandrino portautensile **2**.



Uso

Messa in funzione

Impostazione del senso di rotazione (vedi figura C)

Con il commutatore del senso di rotazione **9** è possibile modificare il senso di rotazione dell'elettrotensile. Comunque, ciò non è possibile quando l'interruttore di avvio/arresto **8** è premuto.

Rotazione destrorsa: Per avvitare viti, premere completamente il commutatore del senso di rotazione **9** verso sinistra fino alla battuta di arresto.



La visualizzazione della direzione di marcia rotazione destrorsa **4** si illumina quando si aziona l'interruttore di avvio/arresto **8** ed il motore è in funzione.

Rotazione sinistrorsa: Per allentare oppure svitare viti, premere completamente il commutatore del senso di rotazione **9** verso destra fino alla battuta di arresto.



La visualizzazione della direzione di marcia rotazione sinistrorsa **6** si illumina quando si aziona l'interruttore di avvio/arresto **8** ed il motore è in funzione.

Preselezione della coppia

Con l'anello di regolazione preselezione della coppia **3** è possibile preselezionare la coppia necessaria in 10 livelli. Non appena la coppia regolata è raggiunta, l'accessorio viene fermato.

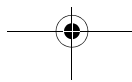

Livello 1:

Momento di coppia minore per avvitare viti con un diametro piccolo oppure in materiali teneri.

Livello 10:

Momento di coppia maggiore per avvitare viti con un diametro grande oppure in materiali duri.

Accendere/spegnere

Per **accendere** l'elettrotensile premere l'interruttore di avvio/arresto **8** e tenerlo premuto.

La lampadina **7** è illuminata in caso di interruttore di avvio/arresto **8** premuto leggermente oppure premuto completamente e consente l'illuminazione del settore di lavoro in caso di condizioni di luce sfavorevoli.

Per **spegnere** l'elettrotensile rilasciare di nuovo l'interruttore di avvio/arresto **8**.

Regolazione del numero di giri

È possibile regolare la velocità dell'elettrotensile in funzione operando con la pressione che si esercita sull'interruttore avvio/arresto **8**.

Esercitando una leggera pressione sull'interruttore di avvio/arresto **8** si ha una velocità bassa. Aumentando la pressione si aumenta la velocità.

Blocco automatico del mandrino (Auto-Lock)

Quando l'interruttore di avvio/arresto **8** non è premuto si blocca il mandrino e con esso il mandrino portautensile.

In questo modo è possibile avvitare viti anche in caso di batteria scarica oppure utilizzare l'elettrotensile come cacciavite.

124 | Italiano

Protezione termosensibile contro sovraccarichi

In caso di uso corretto non è possibile sottoporre l'elettrotroutensile a carico eccessivo. In caso di carico eccessivo oppure di superamento della temperatura ammessa della batteria ricaricabile pari a 70 °C il sistema elettronico spegne l'elettrotroutensile fino a quando non avrà di nuovo raggiunto il campo di temperatura ottimale per l'esercizio.

Protezione contro lo scaricamento totale

La batteria ricaricabile agli ioni di litio non è protetta dalla «Electronic Cell Protection (ECP)» contro lo scaricamento completo. In caso di batteria scarica l'elettrotroutensile si spegne attraverso un interruttore automatico: Il portautensile od accessorio non si muove più.

Indicazioni operative

- **Applicare l'elettrotroutensile sulla vite soltanto quando è spento.** Utensili accessori in rotazione possono scivolare.

Manutenzione ed assistenza

Manutenzione e pulizia

- **Prima di effettuare lavori all'elettrotroutensile (ad es. lavori di manutenzione, cambio d'utensile, ecc.), nonché in caso di trasporto e di conservazione dello stesso, avere sempre cura di portare in posizione media il commutatore per la reversibilità.** In difetto, sussisterà il pericolo di lesioni in caso di azionamento accidentale dell'interruttore di avvio/di arresto.



► **Per poter garantire buone e sicure operazioni di lavoro, tenere sempre puliti l'elettrotensile e le prese di ventilazione.**

Se la batteria ricaricabile non dovesse più funzionare, rivolgersi ad un Centro per il Servizio Clienti elettrotensili Bosch autorizzato.

Se nonostante gli accurati procedimenti di produzione e di controllo l'elettrotensile dovesse guastarsi, la riparazione va fatta effettuare da un punto di assistenza autorizzato per gli elettrotensili Bosch.

In caso di richieste o di ordinazione di pezzi di ricambio, comunicare sempre il codice prodotto a 10 cifre riportato sulla targhetta di fabbricazione dell'elettrotensile!

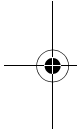

Servizio di assistenza ed assistenza clienti

Il servizio di assistenza risponde alle Vostre domande relative alla riparazione ed alla manutenzione del Vostro prodotto nonché concernenti le parti di ricambio. Disegni in vista esplosa ed informazioni relative alle parti di ricambio sono consultabili anche sul sito:

www.bosch-pt.com

Il team assistenza clienti Bosch è a Vostra disposizione per rispondere alle domande relative all'acquisto, impiego e regolazione di apparecchi ed accessori.

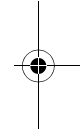

Italia

Officina Riparazioni Elettrotensili c/o GEODIS

Viale Lombardia 18

20010 Arluno

Tel.: +39 (02) 36 96 26 63

Fax: +39 (02) 36 96 26 62

e-mail: officina.elettrotensili@it.bosch.com

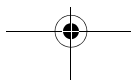

**Svizzera**

Tel.: +41 (044) 8 47 15 13

Fax: +41 (044) 8 47 15 53

Trasporto

La batteria ricaricabile è stata collaudata secondo il manuale UN [Recommendations on the Transport of Dangerous Goods, Manual of Tests and Criteria]

ST/SG/AC.10/11/Rev.3 Parte III, sottoparagrafo 38.3. Essa è dotata sia di un'efficace protezione contro la sovrappressione interna e pericolo di corto circuito che di dispositivi adatti ad impedirne una rottura dovuta a sovraccarico ed il pericolo di corrente inversa.

La quantità di equivalente di litio contenuta nella batteria ricaricabile si trova al di sotto dei valori di soglia vigenti. Per questo motivo la batteria ricaricabile quale singolo elemento o come elemento applicato in una macchina non rientra tra i prodotti considerati particolarmente pericolosi nelle norme nazionali o internazionali. In caso di trasporto di diverse batterie ricaricabili, può comunque darsi il caso che le norme relative ai prodotti pericolosi acquistino rilevanza. In questo caso può essere necessario attenersi alle speciali condizioni (p. es. l'imballaggio) in esse prescritte. Per ulteriori informazioni è possibile consultare il foglio di istruzioni in lingua inglese reperibile al seguente sito internet: <http://purchasing.bosch.com/en/start/Allgemeines/Download/index.htm>.

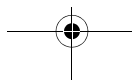
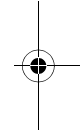
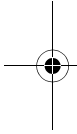

Smaltimento

Avviare ad un riciclaggio rispettoso dell'ambiente gli imballaggi, gli elettrodomestici e gli accessori dismessi.

Solo per i Paesi della CE:



Non gettare elettrodomestici dismessi tra i rifiuti domestici!

Conformemente alla norma della direttiva 2002/96/CE sui rifiuti di apparecchiature elettriche ed elettroniche (RAEE) ed all'attuazione del recepimento nel diritto nazionale, gli elettrodomestici diventati inservibili devono essere raccolti separatamente ed essere inviati ad una riutilizzazione ecologica.

Batterie ricaricabili/Batterie:



Li-Ion:

Si prega di tener presente le indicazioni riportate nel paragrafo «Trasporto», pagina 126.

Qualunque sia il tipo di batteria esaurita, essa non deve essere gettata tra i rifiuti domestici, nel fuoco o nell'acqua. Ogni tipo di batteria esaurita deve essere, riciclata oppure smaltita rispettando rigorosamente la protezione dell'ambiente.



128 | Italiano



Solo per i Paesi della CE:

Ogni tipo di batteria difettosa oppure esaurita deve essere riciclata secondo la direttiva CEE 91/157.

Le batterie ricaricabili/le batterie non funzionanti potranno essere consegnate direttamente presso:

Italia

Ecoelit
Viale Misurata 32
20146 Milano
Tel.: +39 02 / 4 23 68 63
Fax: +39 02 / 48 95 18 93

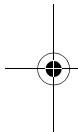

Svizzera

Batrec AG
3752 Wimmis BE

Per estrarre la batteria ricaricabile dall'elettrotensile, premere l'interruttore di avvio/arresto **8** fino al momento in cui la batteria ricaricabile si sarà scaricata completamente. Svitare completamente le viti della carcassa e togliere il rivestimento portante a guscio. Staccare i collegamenti alla batteria ricaricabile ed estrarre la batteria ricaricabile.

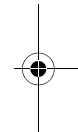

Con ogni riserva di modifiche tecniche.

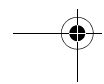
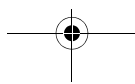

Veiligheidsvoorschriften

Algemene veiligheidswaarschuwingen voor elektrische gereedschappen

⚠ WAARSCHUWING Lees alle veiligheidswaarschuwingen en alle voorschriften. Als de waarschuwingen en voorschriften niet worden opgevolgd, kan dit een elektrische schok, brand of ernstig letsel tot gevolg hebben.

Bewaar alle waarschuwingen en voorschriften voor toekomstig gebruik.

Het in de waarschuwingen gebruikte begrip „elektrisch gereedschap” heeft betrekking op elektrische gereedschappen voor gebruik op het stroomnet (met netsnoer) en op elektrische gereedschappen voor gebruik met een accu (zonder netsnoer).

1) Veiligheid van de werkomgeving

- a) **Houd uw werkomgeving schoon en goed verlicht.**
Een rommelige of onverlichte werkomgeving kan tot ongevallen leiden.
- b) **Werk met het elektrische gereedschap niet in een omgeving met explosiegevaar waarin zich brandbare vloeistoffen, brandbare gassen of brandbaar stof bevinden.** Elektrische gereedschappen veroorzaken vonken die het stof of de dampen tot ontsteking kunnen brengen.
- c) **Houd kinderen en andere personen tijdens het gebruik van het elektrische gereedschap uit de buurt.** Wanneer u wordt afgeleid, kunt u de controle over het gereedschap verliezen.

2) Elektrische veiligheid

- a) De aansluitstekker van het elektrische gereedschap moet in het stopcontact passen. De stekker mag in geen geval worden veranderd. Gebruik geen adapterstekkers in combinatie met geaarde elektrische gereedschappen.** Onveranderde stekkers en passende stopcontacten beperken het risico van een elektrische schok.
- b) Voorkom aanraking van het lichaam met geaarde oppervlakken, bijvoorbeeld van buizen, verwarmingen, fornuizen en koelkasten.** Er bestaat een verhoogd risico door een elektrische schok wanneer uw lichaam geaard is.
- c) Houd het gereedschap uit de buurt van regen en vocht.** Het binnendringen van water in het elektrische gereedschap vergroot het risico van een elektrische schok.
- d) Gebruik de kabel niet voor een verkeerd doel, om het elektrische gereedschap te dragen of op te hangen of om de stekker uit het stopcontact te trekken. Houd de kabel uit de buurt van hitte, olie, scherpe randen en bewegende gereedschapsdelen.** Beschadigde of in de war geraakte kabels vergroten het risico van een elektrische schok.
- e) Wanneer u buitenshuis met elektrisch gereedschap werkt, dient u alleen verlengkabels te gebruiken die voor gebruik buitenshuis zijn goedgekeurd.** Het gebruik van een voor gebruik buitenshuis geschikte verlengkabel beperkt het risico van een elektrische schok.

f) Als het gebruik van het elektrische gereedschap in een vochtige omgeving onvermijdelijk is, dient u een aardlekschakelaar te gebruiken. Het gebruik van een aardlekschakelaar vermindert het risico van een elektrische schok.

3) Veiligheid van personen

a) Wees alert, let goed op wat u doet en ga met verstand te werk bij het gebruik van het elektrische gereedschap. Gebruik geen elektrisch gereedschap wanneer u moe bent of onder invloed staat van drugs, alcohol of medicijnen. Een moment van onoplettendheid bij het gebruik van het elektrische gereedschap kan tot ernstige verwondingen leiden.

b) Draag persoonlijke beschermende uitrusting. Draag altijd een veiligheidsbril. Het dragen van persoonlijke beschermende uitrusting zoals een stofmasker, slipvaste werkschoenen, een veiligheidshelm of gehoorbescherming, afhankelijk van de aard en het gebruik van het elektrische gereedschap, vermindert het risico van verwondingen.

c) Voorkom per ongeluk inschakelen. Controleer dat het elektrische gereedschap uitgeschakeld is voordat u de stekker in het stopcontact steekt of de accu aansluit en voordat u het gereedschap oppakt of draagt. Wanneer u bij het dragen van het elektrische gereedschap uw vinger aan de schakelaar hebt of wanneer u het gereedschap ingeschakeld op de stroomvoorziening aansluit, kan dit tot ongevallen leiden.

132 | Nederlands

d) Verwijder instelgereedschappen of schroefsleutels voordat u het elektrische gereedschap inschakelt. Een instelgereedschap of sleutel in een draaiend deel van het gereedschap kan tot verwondingen leiden.

e) Voorkom een onevenwichtige lichaamshouding. Zorg ervoor dat u stevig staat en steeds in evenwicht blijft. Daardoor kunt u het elektrische gereedschap in onverwachte situaties beter onder controle houden.

f) Draag geschikte kleding. Draag geen loshangende kleding of sieraden. Houd haren, kleding en handschoenen uit de buurt van bewegende delen. Loshangende kleding, lange haren en sieraden kunnen door bewegende delen worden meegenomen.

g) Wanneer stofafzuigings- of stofopvangvoorzieningen kunnen worden gemonteerd, dient u zich ervan te verzekeren dat deze zijn aangesloten en juist worden gebruikt. Het gebruik van een stofafzuiging beperkt het gevaar door stof.

4) Zorgvuldige omgang met en zorgvuldig gebruik van elektrische gereedschappen

a) Overbelast het gereedschap niet. Gebruik voor uw werkzaamheden het daarvoor bestemde elektrische gereedschap. Met het passende elektrische gereedschap werkt u beter en veiliger binnen het aangegeven capaciteitsbereik.

b) Gebruik geen elektrisch gereedschap waarvan de schakelaar defect is. Elektrisch gereedschap dat niet meer kan worden in- of uitgeschakeld, is gevaarlijk en moet worden gerepareerd.



- c) Trek de stekker uit het stopcontact of neem de accu uit het elektrische gereedschap voordat u het gereedschap instelt, toebehoren wisselt of het gereedschap weglegt.** Deze voorzorgsmaatregel voorkomt onbedoeld starten van het elektrische gereedschap.
- d) Bewaar niet-gebruikte elektrische gereedschappen buiten bereik van kinderen. Laat het gereedschap niet gebruiken door personen die er niet mee vertrouwd zijn en deze aanwijzingen niet hebben gelezen.** Elektrische gereedschappen zijn gevaarlijk wanneer deze door onervaren personen worden gebruikt.
- e) Verzorg het elektrische gereedschap zorgvuldig. Controleer of bewegende delen van het gereedschap correct functioneren en niet vastklemmen en of onderdelen zodanig gebroken of beschadigd zijn dat de werking van het elektrische gereedschap nadelig wordt beïnvloed. Laat deze beschadigde onderdelen voor het gebruik repareren.** Veel ongevallen hebben hun oorzaak in slecht onderhouden elektrische gereedschappen.
- f) Houd snijdende inzetgereedschappen scherp en schoon.** Zorgvuldig onderhouden snijdende inzetgereedschappen met scherpe snijkanten klemmen minder snel vast en zijn gemakkelijker te geleiden.
- g) Gebruik elektrisch gereedschap, toebehoren, inzetgereedschappen en dergelijke volgens deze aanwijzingen. Let daarbij op de arbeidsomstandigheden en de uit te voeren werkzaamheden.** Het gebruik van elektrische gereedschappen voor andere dan de voorziene toepassingen kan tot gevaarlijke situaties leiden.

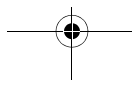
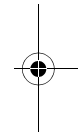
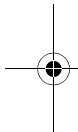

134 | Nederlands**5) Gebruik en onderhoud van accugereedschappen**

a) Laad accu's alleen op in oplaadapparaten die door de fabrikant worden geadviseerd. Voor een oplaadapparaat dat voor een bepaald type accu geschikt is, bestaat brandgevaar wanneer het met andere accu's wordt gebruikt.

b) Gebruik alleen de daarvoor bedoelde accu's in de elektrische gereedschappen. Het gebruik van andere accu's kan tot verwondingen en brandgevaar leiden.

c) Voorkom aanraking van de niet-gebruikte accu met paperclips, munten, sleutels, spijkers, schroeven en andere kleine metalen voorwerpen die overbrugging van de contacten kunnen veroorzaken. Kortsluiting tussen de accucontacten kan brandwonden of brand tot gevolg hebben.

d) Bij verkeerd gebruik kan vloeistof uit de accu lekken. Voorkom contact daarmee. Spoel bij onvoorziën contact met water af. Wanneer de vloeistof in de ogen komt, dient u bovendien een arts te raadplegen. Gelekte accuvloeistof kan tot huidirritaties en verbrandingen leiden.

6) Service

a) Laat het elektrische gereedschap alleen repareren door gekwalificeerd en vakkundig personeel en alleen met originele vervangingsonderdelen. Daarmee wordt gewaarborgd dat de veiligheid van het gereedschap in stand blijft.

Veiligheidsvoorschriften voor schroeven- draaiers

- ▶ **Houd het gereedschap aan de geïsoleerde greepvlakken vast als u werkzaamheden uitvoert waarbij de schroef verborgen stroomleidingen kan raken.** Contact van de schroef met een onder spanning staande leiding kan ook metalen delen van het gereedschap onder spanning zetten en tot een elektrische schok leiden.
- ▶ **Houd het elektrische gereedschap goed vast.** Bij het vast- of losdraaien van schroeven kunnen gedurende korte tijd grote reactiemomenten optreden.
- ▶ **Zet het werkstuk vast.** Een met spanvoorzieningen of een bankschroef vastgehouden werkstuk wordt beter vastgehouden dan u met uw hand kunt doen.
- ▶ **Zet de draairichtingschakelaar in de middelste stand voor werkzaamheden aan het elektrische gereedschap (zoals het uitvoeren van onderhoud en het wisselen van inzetgereedschap) en voordat u het gereedschap vervoert of opbergt.** Bij per ongeluk bedienen van de aan/uit-schakelaar bestaat verwondingsgevaar.
- ▶ **Voorkom per ongeluk inschakelen. Controleer dat de aan/uit-schakelaar in de uitgeschakelde stand staat voordat u een accu inzet.** Het dragen van het elektrische gereedschap met uw vinger aan de aan/uit-schakelaar of het inzetten van de accu in het ingeschakelde elektrische gereedschap kan tot ongevallen leiden.
- ▶ **Open de accu niet.** Er bestaat gevaar voor kortsluiting.



Bescherm het elektrische gereedschap tegen warmte, bijvoorbeeld ook tegen continu zonlicht en vuur. Er bestaat explosiegevaar.

136 | Nederlands

- ▶ **Bij beschadiging en onjuist gebruik van de accu kunnen er dampen vrijkomen. Zorg voor frisse lucht en raadpleeg bij klachten een arts.** De dampen kunnen de luchtwegen irriteren.
- ▶ **Als de accu defect is, kan er vloeistof uit de accu lekken, waardoor aangrenzende voorwerpen worden bevochtigd. Controleer de betrokken onderdelen.** Reinig deze of vervang ze indien nodig.

Veiligheidsvoorschriften voor oplaadapparaten

Houd het oplaadapparaat uit de buurt van regen en vocht. Het binnendringen van water in het oplaadapparaat vergroot het risico van een elektrische schok.

- ▶ **Laad geen accu's van andere fabrikanten op.** Het oplaadapparaat is alleen geschikt voor het opladen van Bosch-lithiumionaccu's met de in de technische gegevens vermelde spanningen. Anders bestaat er brand- en explosiegevaar.
- ▶ **Houd het oplaadapparaat schoon.** Door vervuiling bestaat gevaar voor een elektrische schok.
- ▶ **Controleer voor elk gebruik oplaadapparaat, kabel en stekker. Gebruik het oplaadapparaat niet als u een beschadiging hebt vastgesteld. Open het oplaadapparaat niet zelf en laat het alleen door gekwalificeerd personeel en alleen met originele vervangingsonderdelen repareren.** Beschadigde oplaadapparaten, kabels en stekkers vergroten het risico van een elektrische schok.
- ▶ **Gebruik het oplaadapparaat niet op een gemakkelijk brandbare ondergrond (zoals papier of textiel) of in een brandbare omgeving.** Vanwege de bij het opladen optredende verwarming van het oplaadapparaat bestaat brandgevaar.

Functiebeschrijving



Lees alle veiligheidswaarschuwingen en alle voorschriften. Als de waarschuwingen en voorschriften niet worden opgevolgd, kan dit een elektrische schok, brand of ernstig letsel tot gevolg hebben.

Gebruik volgens bestemming

De machine is bestemd voor het indraaien en losdraaien van schroeven en bouten.

Gebruik het elektrische gereedschap alleen wanneer u alle functies volledig kunt inschatten en zonder beperkingen kunt gebruiken of daarvoor bestemde instructies heeft ontvangen.

Afgebeelde componenten

De componenten zijn genummerd zoals op de afbeelding van het elektrische gereedschap op de pagina met afbeeldingen.

- 1 Bit*
- 2 Gereedschapopname
- 3 Instelring vooraf instelbaar draaimoment
- 4 Draarichtingindicatie rechtsdraaien
- 5 Accu-oplaadindicatie
- 6 Draarichtingindicatie linksdraaien
- 7 Lamp „Power Light”
- 8 Aan/uit-schakelaar
- 9 Draairichtingschakelaar
- 10 Oplaadapparaat

*** Niet elk afgebeeld en beschreven toebehoren wordt standaard meegeleverd. Het volledige toebehoren vindt u in ons toebehorenprogramma.**

138 | Nederlands**Technische gegevens**

Accuschroevendraaier		PSR 7,2 LI
Zaaknummer		3 603 J57 7..
Nominale spanning	V=	7,2
Onbelast toerental	min ⁻¹	0–230
Max. draaimoment harde/flexibele schroefverbinding volgens ISO 5393	Nm	10/6
Max. schroef-Ø	mm	6
Gewicht volgens EPTA-Procedure 01/2003	kg	0,5
Accu		Li-Ion
Capaciteit	Ah	1,3
Aantal accucellen		2
Oplaadapparaat		
Zaaknummer		2 607 225 553 (EU) 2 607 225 555 (UK)
Oplaadtijd	h	5,0

Let op het zaaknummer op het typeplaatje van het elektrische gereedschap. De handelsbenamingen van sommige elektrische gereedschappen kunnen afwijken.



Informatie over geluid en trillingen

Meetwaarden bepaald volgens EN 60745.

Het A-gewogen geluidsdrukniveau van het gereedschap is kenmerkend lager dan 70 dB(A). Onzekerheid K = 3 dB. Het geluidsniveau tijdens de werkzaamheden kan 80 dB(A) overschrijden.

Draag een gehoorbescherming.

Totale trillingswaarden (vectorsom van drie richtingen) bepaald volgens EN 60745:

schroeven: Trillingsemisiewaarde $a_h < 2,5 \text{ m/s}^2$, onzekerheid K = $1,5 \text{ m/s}^2$.

Het in deze gebruiksaanwijzing vermelde trillingsniveau is gemeten met een volgens EN 60745 genormeerde meetmethode en kan worden gebruikt om elektrische gereedschappen met elkaar te vergelijken. Het is ook geschikt voor een voorlopige inschatting van de trillingsbelasting. Het aangegeven trillingsniveau representeert de voornaamste toepassingen van het elektrische gereedschap. Als echter het elektrische gereedschap wordt gebruikt voor andere toepassingen, met afwijkende inzetgereedschappen of onvoldoende onderhoud, kan het trillingsniveau afwijken. Dit kan de trillingsbelasting gedurende de gehele arbeidsperiode duidelijk verhogen.

Voor een nauwkeurige schatting van de trillingsbelasting moet ook rekening worden gehouden met de tijd waarin het gereedschap uitgeschakeld is, of waarin het gereedschap wel loopt, maar niet werkelijk wordt gebruikt. Dit kan de trillingsbelasting gedurende de gehele arbeidsperiode duidelijk verminderen.

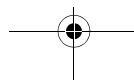
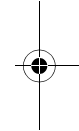
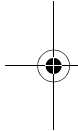



140 | Nederlands



Leg aanvullende veiligheidsmaatregelen ter bescherming van de bediener tegen het effect van trillingen vast, zoals: Onderhoud van elektrische gereedschappen en inzetgereedschappen, warm houden van de handen, organisatie van het arbeidsproces.

Conformiteitsverklaring 

Wij verklaren als alleen verantwoordelijke dat het onder „Technische gegevens” beschreven product voldoet aan de volgende normen en normatieve documenten: EN 60745 (accugereedschappen) resp. EN 60335 (accuoplaadapparaten) volgens de bepalingen van de richtlijnen 2006/95/EG, 2004/108/EG, 98/37/EG (tot 28-12-2009) en 2006/42/EG (vanaf 29-12-2009).

Technisch dossier bij:
Robert Bosch GmbH, PT/ESC,
D-70745 Leinfelden-Echterdingen

 08

Dr. Egbert Schneider	Dr. Eckerhard Strötgen
Senior Vice President	Head of Product
Engineering	Certification

ppa. Schneider *i.v. Strötgen*

Robert Bosch GmbH, Power Tools Division
D-70745 Leinfelden-Echterdingen
16.09.2008



Montage

Accu opladen (zie afbeelding A)

- ▶ **Gebruik geen ander oplaadapparaat.** Het meegeleverde oplaadapparaat is afgestemd op de in het elektrische gereedschap ingebouwde lithium-ion accu.
- ▶ **Let op de netspanning!** De spanning van de stroombron moet overeenkomen met de gegevens op het typeplaatje van het oplaadapparaat. Met 230 V aangeduide oplaadapparaten kunnen ook met 220 V worden gebruikt.

Opmerking: De accu wordt gedeeltelijk opgeladen geleverd. Om de volledige capaciteit van de accu te verkrijgen, laadt u voor het eerste gebruik de accu volledig in het oplaadapparaat op.

De lithiumionaccu kan op elk moment worden opgeladen zonder de levensduur te verkorten. Een onderbreking van het opladen schaadt de accu niet.

De lithiumionaccu is door middel van „Electronic Cell Protection (ECP)” beschermd tegen te sterk ontladen. Als de accu leeg is, wordt het elektrische gereedschap door een veiligheidsschakeling uitgeschakeld. Het inzetgereedschap beweegt niet meer.

⚠ LET OP **Druk na het automatisch uitschakelen van het elektrische gereedschap niet meer op de aan/uit-schakelaar.** De accu kan anders beschadigd worden.

Het opladen begint zodra de stekker van het oplaadapparaat in het stopcontact wordt gestoken en de accuschroevendraaier vervolgens op het oplaadapparaat **10** wordt geplaatst.

142 | Nederlands

De accuoplaadindicatie **5** geeft de voortgang tijdens het opladen aan. Tijdens het opladen **knippert** de indicatie groen. De accu is volledig opgeladen als de indicatie **continu** groen brandt.

Tijdens het opladen wordt de handgreep van het elektrische gereedschap warm. Dit is normaal.

Als het oplaadapparaat langdurig niet wordt gebruikt, dient u de verbinding met het stroomnet te verbreken.

Het elektrische gereedschap kan tijdens het opladen niet worden gebruikt. Het is niet defect wanneer het tijdens het opladen niet werkt.

Neem de voorschriften ten aanzien van de afvalverwijdering in acht.

Inzetgereedschap wisselen (zie afbeelding B)

► **Zet de draairichtingomschakelaar in de middelste stand voor werkzaamheden aan het elektrische gereedschap (zoals het uitvoeren van onderhoud en het wisselen van inzetgereedschap) en voordat u het gereedschap vervoert of opbergt.** Bij per ongeluk bedienen van de aan/uit-schakelaar bestaat verwondingsgevaar.

► **Gebruik geen dubbele bits die langer dan 25 mm zijn.**

Plaats het bit **1** rechtstreeks in de gereedschapopname **2**.

Gebruik

Ingebruikneming

Draairichting instellen (zie afbeelding C)

Met de draairichtingschakelaar **9** kunt u de draairichting van het elektrische gereedschap veranderen. Als de aan/uit-schakelaar **8** is ingedrukt, is dit echter niet mogelijk.

Rechtsdraaien: Als u schroeven wilt indraaien, duwt u de draairichtingschakelaar **9** naar links tot aan de aanslag door.

 De draairichtingindicatie voor rechtsdraaien **4** brandt als de aan/uit-schakelaar **8** wordt bediend en de motor loopt.

Linksdraaien: Als u schroeven wilt uit- of losdraaien, duwt u de draairichtingschakelaar **9** naar rechts tot aan de aanslag door.

 De draairichtingindicatie voor linksdraaien **6** brandt als de aan/uit-schakelaar **8** wordt bediend en de motor loopt.

Draaimoment vooraf instellen

Met de instelring vooraf instelbaar draaimoment **3** kunt u het benodigde draaimoment in 10 stappen vooraf instellen. Zodra het ingestelde draaimoment bereikt is, wordt het inzetgereedschap gestopt.

Stand 1:

Kleiner draaimoment voor het indraaien van schroeven met een kleine diameter of in zachte materialen.

Stand 10:

Groter draaimoment voor het indraaien van schroeven met een grote diameter of in harde materialen.



In- en uitschakelen

Als u het elektrische gereedschap wilt **inschakelen** drukt u op de aan/uit-schakelaar **8** en houdt u deze ingedrukt.

De lamp **7** brandt als de aan/uit-schakelaar **8** licht of volledig is ingedrukt. Met de lamp kan de plaats waar wordt gewerkt bij ongunstige lichtomstandigheden worden verlicht.

Als u het elektrische gereedschap wilt **uitschakelen** laat u de aan-/uitschakelaar **8** los.

Toerental instellen

U kunt het toerental van het ingeschakelde elektrische gereedschap traploos regelen naarmate u de aan/uit-schakelaar **8** indrukt.

Lichte druk op de aan/uit-schakelaar **8** heeft een lager toerental tot gevolg. Met toenemende druk wordt het toerental hoger.

Volautomatische blokkering van de uitgaande as (Auto-Lock)

Als de aan/uit-schakelaar **8** niet is ingedrukt, wordt de uitgaande as en daarmee de gereedschapopname geblokkeerd.

Hierdoor kunnen schroeven ook als de accu leeg is worden ingedraaid en kan het elektrische gereedschap ook als schroevendraaier worden gebruikt.

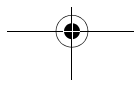
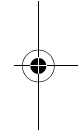
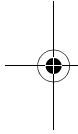

Temperatuurafhankelijke beveiliging tegen overbelasting

Bij gebruik volgens de voorschriften kan het elektrische gereedschap niet worden overbelast. Bij te sterke belasting of overschrijding van de toegestane accutemperatuur van 70 °C schakelt de elektronica het elektrische gereedschap uit tot het zich weer in het optimale bedrijfstemperatuurbereik bevindt.

Bescherming tegen te sterk ontladen

De lithiumionaccu is door middel van „Electronic Cell Protection (ECP)” beschermd tegen te sterk ontladen. Als de accu leeg is, wordt het elektrische gereedschap door een veiligheidsschakeling uitgeschakeld. Het inzetgereedschap beweegt niet meer.

Tips voor de werkzaamheden

- **Plaats het elektrische gereedschap alleen uitgeschakeld op de schroef.** Draaiende inzetgereedschappen kunnen uitglijden.

Onderhoud en service

Onderhoud en reiniging

- **Zet de draairichtingschakelaar in de middelste stand voor werkzaamheden aan het elektrische gereedschap (zoals het uitvoeren van onderhoud en het wisselen van inzetgereedschap) en voordat u het gereedschap vervoert of opbergt.** Bij per ongeluk bedienen van de aan/uit-schakelaar bestaat verwondingsgevaar.



146 | Nederlands



► Houd het elektrische gereedschap en de ventilatieopeningen altijd schoon om goed en veilig te werken.

Neem contact op met een erkende klantenservicewerkplaats voor Bosch elektrische gereedschappen als de accu niet meer naar behoren werkt.

Mocht het elektrische gereedschap ondanks zorgvuldige fabricage- en testmethoden toch defect raken, dient de reparatie te worden uitgevoerd door een erkende klantenservice voor Bosch elektrische gereedschappen.

Vermeld bij vragen en bestellingen van vervangingsonderdelen altijd het uit tien cijfers bestaande zaaknummer volgens het typeplaatje van het elektrische gereedschap.

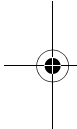

Klantenservice en advies

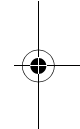

Onze klantenservice beantwoordt uw vragen over reparatie en onderhoud van uw product en over vervangingsonderdelen. Explosietekeningen en informatie over vervangingsonderdelen vindt u ook op:

www.bosch-pt.com

De medewerkers van onze klantenservice adviseren u graag bij vragen over de aankoop, het gebruik en de instelling van producten en toebehoren.

Nederland

Tel.: +31 (076) 579 54 54

Fax: +31 (076) 579 54 94

E-mail: gereedschappen@nl.bosch.com

België en Luxemburg

Tel.: +32 (070) 22 55 65

Fax: +32 (070) 22 55 75

E-mail: outillage.gereedschap@be.bosch.com

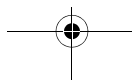

Vervoer

De accu is getest volgens UN-handboek ST/SG/AC.10/11/Rev.3 deel III, paragraaf 38.3. De accu heeft een werkzame bescherming tegen inwendige overdruk en kortsluiting en voorzieningen ter voorkoming van breuk door geweld en gevaarlijke terugstroom. De in de accu aanwezige lithiumequivalentiehoeveelheid ligt onder de geldende grenswaarden. Daarom zijn op de accu (als los onderdeel of in het gereedschap ingezet) geen nationale of internationale voorschriften voor gevaarlijke goederen van toepassing. De voorschriften voor gevaarlijke goederen kunnen echter bij het vervoer van meerdere accu's relevant zijn. Het kan in dit geval noodzakelijk zijn om bijzondere voorwaarden (bijvoorbeeld bij de verpakking) in acht te nemen. Meer informatie vindt u in een informatieblad in het Engels onder het volgende internetadres: <http://purchasing.bosch.com/en/start/Allgemeines/Download/index.htm>.

Afvalverwijdering

Elektrische gereedschappen, toebehoren en verpakkingen moeten op een voor het milieu verantwoorde wijze worden hergebruikt.

Alleen voor landen van de EU:



Gooi elektrische gereedschappen niet bij het huisvuil. Volgens de Europese richtlijn 2002/96/EG over elektrische en elektronische oude apparaten en de omzetting van de richtlijn in nationaal recht moeten niet meer bruikbare elektrische gereedschappen apart worden ingezameld en op een voor het milieu verantwoorde wijze worden hergebruikt.

Accu's en batterijen:



Li-ion:

Lees de aanwijzingen in het gedeelte „Vervoer”, pagina 147 en neem deze in acht.

Gooi accu's of batterijen niet bij het huisvuil en evenmin in het vuur of het water. Accu's en batterijen moeten worden ingezameld, gerecycled of op een voor het milieu verantwoorde wijze worden afgevoerd.

Alleen voor landen van de EU:

Volgens richtlijn 91/157/EEG moeten defecte of versleten accu's en batterijen worden gerecycled.

Als u de accu uit het elektrische gereedschap wilt nemen, bedient u de aan/uit-schakelaar **8** totdat de accu volledig leeg is. Draai de schroeven van het machinehuis los en verwijder de schaal van het huis. Maak de aansluitingen op de accu los en neem de accu uit het gereedschap.

Wijzigingen voorbehouden.

Sikkerhedsinstrukser

Generelle advarselshenvisninger for el-værktøj

⚠ ADVARSEL Læs alle advarselshenvisninger og instrukser. I tilfælde af manglende overholdelse af advarselshenvisningerne og instrukserne er der risiko for elektrisk stød, brand og/eller alvorlige kvæstelser.

Opbevar alle advarselshenvisninger og instrukser til senere brug.

Det i advarselshenvisningerne benyttede begreb „el-værktøj“ refererer til netdrevet el-værktøj (med netkabel) og akkudrevet el-værktøj (uden netkabel).

1) Sikkerhed på arbejdspladsen

- a) **Sørg for, at arbejdsområdet er rent og rigtigt belyst.** Uorden eller uoplyste arbejdsområder øger faren for uheld.
- b) **Brug ikke el-værktøjet i eksplosionsfarlige omgivelser, hvor der findes brændbare væsker, gasser eller støv.** El-værktøj kan slå gnister, der kan antænde støv eller dampe.
- c) **Sørg for, at andre personer og ikke mindst børn holdes væk fra arbejdsområdet, når maskinen er i brug.** Hvis man distraheres, kan man miste kontrollen over maskinen.

2) Elektrisk sikkerhed

- a) **El-værktøjets stik skal passe til kontakten. Stikket må under ingen omstændigheder ændres. Brug ikke adapterstik sammen med jordforbundet el-værktøj.** Uændrede stik, der passer til kontakterne, nedsætter risikoen for elektrisk stød.

b) Undgå kropskontakt med jordforbundne overflader som f.eks. rør, radiatorer, komfurer og køleskabe. Hvis din krop er jordforbundet, øges risikoen for elektrisk stød.

c) Maskinen må ikke udsættes for regn eller fugt. Indtrængning af vand i et el-værktøj øger risikoen for elektrisk stød.

d) Brug ikke ledningen til formål, den ikke er beregnet til (f.eks. må man aldrig bære el-værktøjet i ledningen, hænge el-værktøjet op i ledningen eller rykke i ledningen for at trække stikket ud af kontakten). Beskyt ledningen mod varme, olie, skarpe kanter eller maskindele, der er i bevægelse. Beskadigede eller indviklede ledninger øger risikoen for elektrisk stød.

e) Hvis el-værktøjet benyttes i det fri, må der kun benyttes en forlængerledning, der er egnet til udendørs brug. Brug af forlængerledning til udendørs brug nedsætter risikoen for elektrisk stød.

f) Hvis det ikke kan undgås at bruge el-værktøjet i fugtige omgivelser, skal der bruges et HFI-relæ. Brug af et HFI-relæ reducerer risikoen for at få elektrisk stød.

3) Personlig sikkerhed

a) Det er vigtigt at være opmærksom, se, hvad man laver, og bruge el-værktøjet fornuftigt. Brug ikke noget el-værktøj, hvis du er træt, har nydt alkohol eller er påvirket af medikamenter eller euforiserende stoffer. Få sekunders uopmærksomhed ved brug af el-værktøjet kan føre til alvorlige personskader.



- b) Brug beskyttelsesudstyr og hav altid beskyttelsesbriller på.** Brug af sikkerhedsudstyr som f.eks. støvmaske, skridsikkert fodtøj, beskyttelseshjelm eller høreværn afhængig af maskintype og anvendelse nedsætter risikoen for personskader.
- c) Undgå utilsigtet igangsætning. Kontrollér, at el-værktøjet er slukket, før du tilslutter det til strømtilførslen og/eller akkuen, løfter eller bærer det.** Undgå at bære el-værktøjet med fingeren på afbryderen og sørg for, at el-værktøjet ikke er tændt, når det sluttes til nettet, da dette øger risikoen for personskader.
- d) Gør det til en vane altid at fjerne indstillingsværktøj eller skruenøgle, før el-værktøjet tændes.** Hvis et stykke værktøj eller en nøgle sidder i en roterende maskindel, er der risiko for personskader.
- e) Undgå en anormal legemsposition. Sørg for at stå sikkert, mens der arbejdes, og kom ikke ud af balance.** Dermed har du bedre muligheder for at kontrollere el-værktøjet, hvis der skulle opstå uventede situationer.
- f) Brug egnet arbejdstøj. Undgå løse beklædningsgenstande eller smykker. Hold hår, tøj og handsker væk fra dele, der bevæger sig.** Dele, der er i bevægelse, kan gribe fat i løstsiddende tøj, smykker eller langt hår.
- g) Hvis støvudsugnings- og opsamlingsudstyr kan monteres, er det vigtigt, at dette tilsluttes og benyttes korrekt.** Brug af en støvopsugning kan reducere støvmængden og dermed den fare, der er forbundet støv.

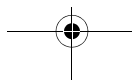
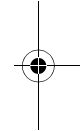
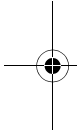

4) Omhyggelig omgang med og brug af el-værktøj

- a) Undgå overbelastning af maskinen. Brug altid et el-værktøj, der er beregnet til det stykke arbejde, der skal udføres.** Med det passende el-værktøj arbejder man bedst og mest sikkert inden for det angivne effektområde.
- b) Brug ikke et el-værktøj, hvis afbryder er defekt.** Et el-værktøj, der ikke kan startes og stoppes, er farligt og skal repareres.
- c) Træk stikket ud af stikkontakten og/eller fjern akkuen, inden maskinen indstilles, der skiftes tilbehørsdele, eller maskinen lægges fra.** Disse sikkerhedsforanstaltninger forhindrer utilsigtet start af el-værktøjet.
- d) Opbevar ubenyttet el-værktøj uden for børns rækkevidde. Lad aldrig personer, der ikke er fortrolige med maskinen eller ikke har gennemlæst disse instrukser, benytte maskinen.** El-værktøj er farligt, hvis det benyttes af ukyndige personer.
- e) El-værktøjet bør vedligeholdes omhyggeligt. Kontroller, om bevægelige maskindele fungerer korrekt og ikke sidder fast, og om delene er brækket eller beskadiget, således at el-værktøjets funktion påvirkes. Få beskadigede dele repareret, inden maskinen tages i brug.** Mange uheld skyldes dårligt vedligeholdte el-værktøjer.
- f) Sørg for, at skæreværktøjer er skarpe og rene.** Omhyggeligt vedligeholdte skæreværktøjer med skarpe skærekanter sætter sig ikke så hurtigt fast og er nemmere at føre.

g) Brug el-værktøj, tilbehør, indsatsværktøj osv. iht. disse instrukser. Tag hensyn til arbejdsforholdene og det arbejde, der skal udføres. Anvendelse af el-værktøjet til formål, som ligger uden for det fastsatte anvendelsesområde, kan føre til farlige situationer.

5) Omhyggelig omgang med og brug af akku-værktøj

- a) Oplad kun akku'er i ladeaggregater, der er anbefalet af fabrikanten.** Et ladeaggregat, der er egnet til en bestemt type batterier, må ikke benyttes med andre batterier – brandfare.
- b) Brug kun de akku'er, der er beregnet til el-værktøjet.** Brug af andre akku'er øger risikoen for personskader og er forbundet med brandfare.
- c) Ikke benyttede akku'er må ikke komme i berøring med kontorclips, mønter, nøgler, søm, skruer eller andre små metalgenstande, da disse kan kortslutte kontakterne.** En kortslutning mellem batterikontakterne øger risikoen for personskader i form af forbrændinger.
- d) Hvis akku'en anvendes forkert, kan der slippe væske ud af akku'en. Undgå at komme i kontakt med denne væske. Hvis det alligevel skulle ske, skylles med vand. Søg læge, hvis væsken kommer i øjnene.** Akku-væske kan give hudirritation eller forbrændinger.

6) Service

- a) Sørg for, at el-værktøj kun repareres af kvalificerede fagfolk og at der kun benyttes originale reservedele.** Dermed sikres størst mulig maskinsikkerhed.

Sikkerhedshenvisninger til skruemaskine

- ▶ **Hold el-værktøjet i de isolerede gribeblader, når du udfører arbejde, hvor skruen kan ramme bøjede strømledninger.** Skruens kontakt med en spændingsførende ledning kan også sætte el-værktøjets metaldele under spænding, hvilket kan føre til elektrisk stød.
- ▶ **Hold el-værktøjet godt fast.** Når skrue spændes og løsnes, kan der opstå korte, høje reaktionsmomenter.
- ▶ **Sikr emnet.** Et emne holdes bedre fast med spændeordninger eller skruestik end med hånden.
- ▶ **Retningsomskifteren skal altid stå i midten, før der indstilles på maskinen (f.eks. vedligeholdelse, værktøjsskift osv.) samt før maskinen transporteres og stilles til opbevaring.** Utilsigtet start ved aktivering af start-stop-kontakten kan føre til kvæstelser.
- ▶ **Undgå utilsigtet tænding. Kontrollér, at start-stop-kontakten står i slukket position, før en akku sættes i.** Undgå at bære el-værktøjet med fingeren på start-stop-kontakten eller at sætte akkuen i el-værktøjet, når det er tændt, da dette kan føre til uheld.
- ▶ **Åben ikke akkuen.** Fare for kortslutning.
 **Beskyt el-værktøjet mod varme f.eks. også mod varige solstråler og brand.** Fare for eksplosion.
- ▶ **Beskadiges akkuen eller bruges den forkert, kan der sive dampe ud. Tilfør frisk luft og søg læge, hvis du føler dig utilpas.** Dampene kan irritere luftvejene.
- ▶ **Er akkuen defekt, kan væske trænge ud og befugte nærliggende genstande. Kontrollér berørte dele.** Rengør disse eller skift dem i givet fald ud.

Sikkerhedsforskrifter for ladeaggregater



Ladeaggregatet må ikke udsættes for regn eller fugtighed. Indtrængning af vand i ladeaggregatet øger risikoen for elektrisk stød.

- ▶ **Lad ikke fremmede akkuer.** Ladeaggregatet er kun beregnet til ladning af Bosch Li-ion-akkuer med de spændinger, der er angivet i de tekniske data. Ellers er der fare for brand og eksplosion.
- ▶ **Renhold ladeaggregatet.** Snavs øger faren for elektrisk stød.
- ▶ **Kontrollér ladeaggregat, kabel og stik før brug. Anvend ikke ladeaggregatet, hvis det er beskadiget. Forsøg ikke at åbne ladeaggregatet og sørg for at det reparerer af kvalificerede fagfolk, og at der kun benyttes originale reservedele.** Beskadigede ladeaggregater, kabler og stik øger risikoen for elektrisk stød.
- ▶ **Anvend ikke ladeaggregatet på let brændbar undergrund (f.eks. papir, tekstiler osv.) eller i brændbare omgivelser.** Pas på! Ladeaggregatet bliver varmt under opladningen. Brandfare!

Funktionsbeskrivelse



Læs alle advarselshenvisninger og instrukser. I tilfælde af manglende overholdelse af advarselshenvisningerne og instrukserne er der risiko for elektrisk stød, brand og/eller alvorlige kvæstelser.



Beregnet anvendelse

Maskinen er beregnet til at iskrue og løsne skruer.

Brug kun el-værktøjet, hvis du er i stand til at vurdere alle funktioner 100 % og gennemføre dem uden indskrænkninger eller har modtaget tilsvarende instruktioner.

Illustrerede komponenter

Nummereringen af de illustrerede komponenter refererer til illustrationen af el-værktøjet på illustrationssiden.

- 1 Skruebit*
- 2 Værktøjsholder
- 3 Ring til indstilling af drejningsmoment
- 4 Indikator for højreløb
- 5 Akku-ladetilstandsindikator
- 6 Indikator for venstreløb
- 7 Lampe „Power Light“
- 8 Start-stop-kontakt
- 9 Retningsomskifter
- 10 Ladeaggregat

***Tilbehør, som er illustreret og beskrevet i betjeningsvejledningen, er ikke indeholdt i leveringen. Det fuldstændige tilbehør findes i vores tilbehørsprogram.**

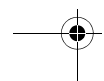
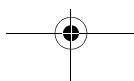
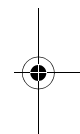
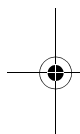

Dansk | 157

Tekniske data

Akku-skruetrækker		PSR 7,2 LI
Typenummer		3 603 J57 7..
Nominel spænding	V=	7,2
Omdrejningstal, ubelastet	min ⁻¹	0–230
Max. drejningsmoment hårdt/blødt skruearbejde iht. ISO 5393	Nm	10/6
Max. skrue-Ø	mm	6
Vægt svarer til EPTA-Procedure 01/2003	kg	0,5
Akku		Li-Ion
Kapacitet	Ah	1,3
Antal akkuceller		2
Ladeaggregat		
Typenummer		2 607 225 553 (EU) 2 607 225 555 (UK)
Ladetid	h	5,0

Se typenummer på el-værktøjets typeskilt. Handelsbetegnelserne for de enkelte el-værktøjer kan variere.



Støj/vibrationsinformation

Måleværdier er beregnet iht. EN 60745.

Værktøjets A-vurderede lydtrykniveau er typisk mindre end 70 dB(A). Usikkerhed K = 3 dB.

Støjniveauet kan overstige 80 dB(A) under arbejdet.

Brug høreværn!

Samlede vibrationsværdier (vektorsum for tre retninger) beregnet iht. EN 60745:

Skruning: Vibrationseksponering $a_{h1} < 2,5 \text{ m/s}^2$, usikkerhed $K = 1,5 \text{ m/s}^2$.

Det svingningsniveau, der er angivet i nærværende instruktioner, er blevet målt iht. en standardiseret måleproces i EN 60745, og kan bruges til at sammenligne el-værktøjer. Det er også egnet til en foreløbig vurdering af svingningsbelastningen.

Det angivende svingningsniveau repræsenterer de væsentlige anvendelser af el-værktøjet. Hvis el-værktøjet dog anvendes til andre formål, med afvigende indsatsværktøj eller utilstrækkelig vedligeholdelse, kan svingningsniveauet afvige. Dette kan føre til en betydelig forøgelse af svingningsbelastningen i hele arbejdstidsrummet.

Til en nøjagtig vurdering af svingningsbelastningen bør der også tages højde for de tider, i hvilke værktøjet er slukket eller godt nok kører, men rent faktisk ikke anvendes. Dette kan føre til en betydelig reduktion af svingningsbelastningen i hele arbejdstidsrummet.

Fastlæg ekstra sikkerhedsforanstaltninger til beskyttelse af brugeren mod svingningers virkning som f.eks.: Vedligeholdelse af el-værktøj og indsatsværktøj, holde hænder varme, organisation af arbejdsforløb.

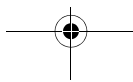
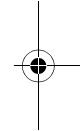
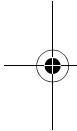

Overensstemmelseserklæring

Vi erklærer under almindeligt ansvar, at det produkt, der er beskrevet under „Tekniske data“, er i overensstemmelse med følgende standarder eller normative dokumenter: EN 60745 (batteridrevne maskiner) resp. EN 60335 (batteridrevne ladeaggregater) iht. bestemmelserne i direktiverne 2006/95/EF, 2004/108/EF, 98/37/EF (indtil 28.12.2009), 2006/42/EF (fra 29.12.2009).

Teknisk dossier hos:
Robert Bosch GmbH, PT/ESC,
D-70745 Leinfelden-Echterdingen

 08

Dr. Egbert Schneider Senior Vice President Engineering	Dr. Eckerhard Strötgen Head of Product Certification
--	--

Dr. Egbert Schneider *Dr. Eckerhard Strötgen*

Robert Bosch GmbH, Power Tools Division
D-70745 Leinfelden-Echterdingen
16.09.2008

Montering

Opladning af akku (se Fig. A)

- **Anvend ikke noget andet ladeaggregat.** Det medleverede ladeaggregat er afstemt, så det passer til den Li-Ion-akku, der er monteret i el-værktøjet.

160 | Dansk

- **Kontrollér netspændingen!** Strømkildens spænding skal stemme overens med angivelserne på ladeaggregatets typeskilt. Ladeaggregater til 230 V kan også tilsluttes 220 V.

Bemærk: Akkuen er til dels oplades ved udleveringen. For at sikre at akkuen fungerer 100 % oplades akkuen helt før første ibrugtagning.

Li-ion-akkuen kan oplades til enhver tid, uden at levetiden forkortes. En afbrydelse af opladningen beskadiger ikke akkuen.

Li-ion-akkuen er beskyttet mod afladning med „Electronic Cell Protection (ECP)“. Er akkuen afladet, slukkes el-værktøjet med en beskyttelseskontakt: Indsatsværktøjet bevæger sig ikke mere.

⚠ PAS PÅ Tryk ikke videre på start-stop-kontakten efter automatisk slukning af el-værktøjet.

Akkuen kan blive beskadiget.

Opladningen går i gang, så snart ladeaggregatets stik sættes i stikdåsen og akku-skruetrækkeren anbringes på ladeaggregatet **10**.

Akku-ladetilstandsindikatoren **5** viser ladefremskridtet. Under opladningen **blinker** visningen grøn. Akkuen er helt opladet, når visningen lyser grøn **hele tiden**.

El-værktøjets håndgreb bliver varmt under opladningen. Dette er helt normalt.

Afbryd ladeaggregatet fra strømnettet, hvis det ikke skal anvendes i længere tid.

El-værktøjet kan ikke anvendes under opladningen; det er ikke defekt, når det ikke fungerer under opladningen.

Læs og overhold henvisningerne mhr. bortskaffelse.

Værktøjsskift (se Fig. B)

- ▶ **Retningsomskifteren skal altid stå i midten, før der indstilles på maskinen (f.eks. vedligeholdelse, værktøjsskift osv.) samt før maskinen transporteres og stilles til opbevaring.** Utilsigtet start ved aktivering af start-stop-kontakten kan føre til kvæstelser.
- ▶ **Brug ikke 2-sidede skrueklanker, der er længere end 25 mm.**

Sæt skruebitten **1** direkte ind i værktøjsholderen **2**.

Brug

Ibrugtagning

Indstil drejeretning (se Fig. C)

Med retningsomskifteren **9** kan du ændre el-værktøjets drejeretning. Ved nedtrykket start-stop-kontakt **8** er dette ikke muligt.

Højreløb: Til idrejning af skrue trykkes retningsomskifteren **9** helt til venstre.

 Drejeretningsindikatoren højreløb **4** lyser, når der trykkes på start-stop-kontakten **8** og motoren går.

Venstreløb: Skrue løsnes og drejes ud ved at trykke drejeretningsomskifteren **9** helt mod højre.

 Drejeretningsindikatoren venstreløb **6** lyser, når der trykkes på start-stop-kontakten **8** og motoren går.



Vælg drejningsmoment

Ringen til indstilling af drejningsmomentet **3** bruges til at indstille det nødvendige drejningsmoment i 10 trin. Så snart det indstillede drejningsmoment er nået, stoppes indsatsværktøjet.

Trin 1:

Lille drejningsmoment til idrejning af skruer med lille diameter eller i bløde materialer.

Trin 10:

Stort drejningsmoment til idrejning af skruer med stor diameter eller i hårde materialer.

Tænd/sluk

Til **ibrugtagning** af el-værktøjet tryk på start-stop-kontakten **8** og hold den nede.

Lampen **7** lyser, når start-stop-kontakten **8** trykkes halvt eller helt ned, hvilket gør det muligt at oplyse arbejdsområdet ved dårlige lysforhold.

El-værktøjet **slukkes** ved at slippe start-stop-kontakten **8**.

Indstil omdrejningstal

Du kan regulere omdrejningstallet til det tændte el-værktøj trinløst afhængigt af hvor meget du trykker på start-stop-kontakten **8**.

Let tryk på start-stop-kontakten **8** fører til et lavt omdrejningstal. Med tiltagende tryk øges omdrejningstallet.

Automatisk spindellås (Auto-Lock)

Borespindlen og dermed værktøjsholderen er fastlåst, når start-stop-kontakten **8** ikke er trykket ned.

Dette gør det muligt at idreje skruer, selv om akkuen er afladet, og at bruge el-værktøjet som skruetrækker.

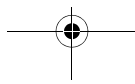
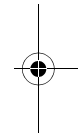
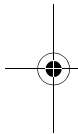

Temperaturlafhængig overbelastningsbeskyttelse

El-værktøjet kan ikke overbelastes, hvis det bruges iht. formålet. Udsættes el-værktøjet for for meget belastning eller overskrider den tilladte akku-temperatur på 70 °C, slukker el-værktøjets elektroniske system, til dette igen befinder sig i det optimale driftstemperaturområde.

Beskyttelse mod dybdeafledning

Li-ion-akkuen er beskyttet mod afladning med „Electronic Cell Protection (ECP)“. Er akkuen afladet, slukkes el-værktøjet med en beskyttelseskontakt: Indsatsværktøjet bevæger sig ikke mere.

Arbejdsvejledning

- **El-værktøjet skal altid være slukket, når det anbringes på skruen.** Roterende indsatsværktøj kan glide af.

Vedligeholdelse og service

Vedligeholdelse og rengøring

- **Retningsomskifteren skal altid stå i midten, før der indstilles på maskinen (f.eks. vedligeholdelse, værktøjsskift osv.) samt før maskinen transporteres og stilles til opbevaring.** Utilsigtet start ved aktivering af start-stop-kontakten kan føre til kvæstelser.
- **El-værktøj og el-værktøjets ventilationsåbninger skal altid holdes rene for at sikre et godt og sikkert arbejde.**



164 | Dansk



Når akkuen ikke fungerer mere, bedes du kontakte et autoriseret serviceværksted for Bosch el-værktøj.

Skulle el-værktøjet trods omhyggelig fabrikation og kontrol holde op med at fungere, skal reparationen udføres af et autoriseret serviceværksted for Bosch-elektroværktøj.

El-værktøjets 10-cifrede typenummer (se typeskilt) skal altid angives ved forespørgsler og bestilling af reservedele.

Kundeservice og kunderådgivning

Kundeservice besvarer dine spørgsmål vedr. reparation og vedligeholdelse af dit produkt samt reservedele. Reservedelstegninger og informationer om reservedele findes også under:

www.bosch-pt.com

Bosch kundeservice-team vil gerne hjælpe dig med at besvare spørgsmål vedr. køb, anvendelse og indstilling af produkter og tilbehør.

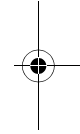
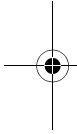

Dansk

Bosch Service Center
Telegrafvej 3
2750 Ballerup
Tel. Service Center: +45 (4489) 8855
Fax: +45 (4489) 87 55
E-Mail: vaerktoej@dk.bosch.com

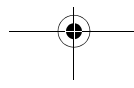

Transport

Akkuen er testet iht. UN-manualen ST/SG/AC.10/11/rev.3 del III, underafsnit 38.3. Den har en effektiv beskyttelse mod indvendigt overtryk og kortslutning; desuden er den udstyret med anordninger, der forhindrer brud som følge af vold og farlig tilbagestrøm.

Litiumækvivalent-mængden i akkuen ligger under de almindelige grænseværdier. Af den grund er akkuen hverken som enkeltstående del eller som del indsat i et værktøj underkastet nationale og internationale forskrifter vedr. farligt gods. Forskrifterne vedr. farligt gods kan dog være relevant, hvis flere akkuer transporteres. I dette tilfælde kan det være nødvendigt at overholde særlige betingelser (f.eks. i forbindelse med emballage). Du kan læse mere herom i det engelsksprogede indsatskort under følgende internetadresse: <http://purchasing.bosch.com/en/start/Allgemeines/Download/index.htm>.

Bortskaffelse

El-værktøj, tilbehør og emballage skal genbruges på en miljøvenlig måde.

Gælder kun i EU-lande:



Smid ikke el-værktøj ud sammen med det almindelige husholdningsaffald!
Iht. det europæiske direktiv 2002/96/EF om affald af elektrisk og elektronisk udstyr skal kasseret elektrisk udstyr indsamles separat og genbruges iht. gældende miljøforskrifter.

Akkuer/batterier:**Li-Ion:**

Læs og overhold henvisningerne i afsnit „Transport“, side 165.

Gamle akkuer/batterier må ikke smides ud sammen med det almindelige husholdningsaffald, ej heller brændes eller smides i vandet. Akkuer/batterier skal indsamles, genbruges eller bortskaffes iht. gældende miljøforskrifter.

Gælder kun i EU-lande:

Iht. direktivet 91/157/EØF skal defekte eller brugte akkuer/batterier genbruges.

Akkuen tages ud af el-værktøjet ved at trykke på start-stop-kontakten **8**, til akkuen er helt afladet. Drej skruerne ud på huset og tag huset af. Afbryd for tilslutningerne på akkuen og tag akkuen ud.

Ret til ændringer forbeholdes.

Säkerhetsanvisningar

Allmänna säkerhetsanvisningar för elverktyg

⚠ VARNING Läs noga igenom alla anvisningar. Fel som uppstår till följd av att anvisningarna nedan inte följts kan orsaka elstöt, brand och/eller allvarliga kroppsskador.

Förvara alla varningar och anvisningar för framtida bruk.

Nedan använt begrepp "Elverktyg" hänför sig till nätdrivna elverktyg (med nätsladd) och till batteridrivna elverktyg (sladdlösa).

1) Arbetsplats säkerhet

- a) **Håll arbetsplatsen ren och välbelyst.** Oordning på arbetsplatsen och dåligt belyst arbetsområde kan leda till olyckor.
- b) **Använd inte elverktyget i explosionsfarlig omgivning med brännbara vätskor, gaser eller damm.** Elverktygen alstrar gnistor som kan antända dammet eller gaserna.
- c) **Håll under arbetet med elverktyget barn och obehöriga personer på betryggande avstånd.** Om du störs av obehöriga personer kan du förlora kontrollen över elverktyget.

2) Elektrisk säkerhet

- a) **Elverktygets stickpropp måste passa till vägguttaget. Stickproppen får absolut inte förändras. Använd inte adapterkontakter tillsammans med skyddsjordade elverktyg.** Oförändrade stickproppar och passande vägguttag reducerar risken för elstöt.

- b) Undvik kroppskontakt med jordade ytor som t. ex. rör, värmeelement, spisar och kylskåp.** Det finns en större risk för elstöt om din kropp är jordad.
- c) Skydda elverktyget mot regn och väta.** Tränger vatten in i ett elverktyg ökar risken för elstöt.
- d) Missbruka inte nätsladden och använd den inte för att bära eller hänga upp elverktyget och inte heller för att dra stickproppen ur vägguttaget. Håll nätsladden på avstånd från värme, olja, skarpa kanter och rörliga maskindelar.** Skadade eller tilltrasslade ledningar ökar risken för elstöt.
- e) När du arbetar med ett elverktyg utomhus använd endast förlängningssladdar som är avsedda för utomhusbruk.** Om en lämplig förlängningssladd för utomhusbruk används minskar risken för elstöt.
- f) Använd ett felströmsskydd om det inte är möjligt att undvika elverktygets användning i fuktig miljö.** Felströmsskyddet minskar risken för elstöt.
- 3) Personsäkerhet**
- a) Var uppmärksam, kontrollera vad du gör och använd elverktyget med förnuft. Använd inte elverktyg när du är trött eller om du är påverkad av droger, alkohol eller mediciner.** Under användning av elverktyg kan även en kort uppmärksamhet leda till allvarliga kroppsskador.

- b) Bär alltid personlig skyddsutrustning och skyddsglasögon.** Användning av personlig skyddsutrustning som t. ex. dammfiltermask, halkfria säkerhetskör, skyddshjälm och hörselskydd reducerar alltefter elverktygets typ och användning risken för kroppsskada.
- c) Undvik oavsiktlig igångsättning. Kontrollera att elverktyget är frånkopplat innan du ansluter stickproppen till vägguttaget och/eller ansluter/tar bort batteriet, tar upp eller bär elverktyget.** Om du bär elverktyget med fingret på strömställaren eller ansluter påkopplat elverktyg till nätströmmen kan olycka uppstå.
- d) Ta bort alla inställningsverktyg och skruvnycklar innan du kopplar på elverktyget.** Ett verktyg eller en nyckel i en roterande komponent kan medföra kroppsskada.
- e) Undvik onormala kroppsställningar. Se till att du står stadigt och håller balansen.** I detta fall kan du lättare kontrollera elverktyget i oväntade situationer.
- f) Bär lämpliga arbetskläder. Bär inte löst hängande kläder eller smycken. Håll håret, kläderna och handskarna på avstånd från rörliga delar.** Löst hängande kläder, långt hår och smycken kan dras in av roterande delar.
- g) Vid elverktyg med dammsugnings- och -uppsamlingsutrustning, se till att denna är rätt monterade och används på korrekt sätt.** Användning av dammsugning minskar de risker damm orsakar.

4) Korrekt användning och hantering av elverktyg

- a) Överbelasta inte elverktyget. Använd för aktuellt arbete avsett elverktyg.** Med ett lämpligt elverktyg kan du arbeta bättre och säkrare inom angivet effektområde.
- b) Ett elverktyg med defekt strömställare får inte längre användas.** Ett elverktyg som inte kan kopplas in eller ur är farligt och måste repareras.
- c) Dra stickproppen ur vägguttaget och/eller ta bort batteriet innan inställningar utförs, tillbehörskomponenter byts ut eller elverktyget lagras.** Denna skyddsåtgärd förhindrar oavsiktlig inkoppling av elverktyget.
- d) Förvara elverktygen oåtkomliga för barn. Låt elverktyget inte användas av personer som inte är förtrogna med dess användning eller inte läst denna anvisning.** Elverktygen är farliga om de används av oerfarna personer.
- e) Sköt elverktyget omsorgsfullt. Kontrollera att rörliga komponenter fungerar felfritt och inte kärvar, att komponenter inte brustit eller skadats; orsaker som kan leda till att elverktygets funktioner påverkas menligt. Låt skadade delar repareras innan elverktyget tas i bruk.** Många olyckor orsakas av dåligt skötta elverktyg.
- f) Håll skärverktygen skarpa och rena.** Omsorgsfullt skötta skärverktyg med skarpa eggar kommer inte så lätt i kläm och går lättare att styra.

g) Använd elverktyget, tillbehör, insatsverktyg osv. enligt dessa anvisningar. Ta hänsyn till arbetsvillkoren och arbetsmomenten. Om elverktyget används på ett sätt som det inte är avsett för kan farliga situationer uppstå.

5) Omsorgsfull hantering och användning av sladdlösa elverktyg

a) Ladda batterierna endast i de laddare som tillverkaren rekommenderat. Om en laddare som är avsedd för en viss typ av batterier används för andra batterityper finns risk för brand.

b) Använd endast batterier som är avsedda för aktuellt elverktyg. Används andra batterier finns risk för kroppsskada och brand.

c) Håll gem, mynt, nycklar, spikar, skruvar och andra små metallföremål på avstånd från reservbatterier för att undvika en bygling av kontakterna. En kortslutning av batteriets kontakter kan leda till brännskador eller brand.

d) Om batteriet används på fel sätt finns risk för att vätska rinner ur batteriet. Undvik kontakt med vätskan. Vid oavsiktlig kontakt spola med vatten. Om vätska kommer i kontakt med ögonen uppsök dessutom läkare. Batterivätskan kan medföra hudirritation och brännskada.

6) Service

a) Låt endast kvalificerad fackpersonal reparera elverktyget och endast med originalreservdelar. Detta garanterar att elverktygets säkerhet upprätthålls.

Säkerhetsanvisningar för skruvdragare

- ▶ **Håll i elverktyget endast vid de isolerade greppytorna när arbeten utförs på ställen där skruven kan skada dolda elledningar.** Skruvens kontakt med en spänningsförande ledning kan sätta maskinens metalldelar under spänning och leda till elstöt.
- ▶ **Håll stadigt tag i elverktyget.** Vid idragning och urdragning av skruvar kan kortvarigt höga reaktionsmoment uppstå.
- ▶ **Säkra arbetsstycket.** Ett arbetsstycke som är fastspänt i en uppspänningsanordning eller ett skruvstycke hålls säkrare än med handen.
- ▶ **Innan åtgärder utförs på elverktyget (t. ex. underhåll, verktygsbyte osv) och för transport och lagring ställ riktningsskopplaren i mittläge.** Om strömställaren Till/Från oavsiktligt påverkas finns risk för kroppsskada.
- ▶ **Undvik oavsiktlig påkoppling. Kontrollera att strömställaren är i frånslaget läge innan batterimodulen sätts in.** Att bära elverktyget med fingret på strömställaren eller att sätta in batterimodulen i påkopplat elverktyg kan leda till olyckor.
- ▶ **Öppna inte batterimodulen.** Detta kan leda till kortslutning.



Skydda elverktyget mot hög värme som t.ex. längre solbestrålning och eld. Explosionsrisk föreligger.

- ▶ **I skadad eller felanvänd batterimodul kan ångor uppstå. Tillför friskluft och uppsök läkare vid åkomor.** Ångorna kan leda till irritation i andningsvägarna.
- ▶ **Från ett defekt batteri kan vätska rinna ut och väta föremål i närheten. Kontrollera berörda delar.** Rengör eller byt ut dem vid behov.

Säkerhetsanvisningar för laddare

-  **Skydda laddaren mot regn och väta.** Tränger vatten in i laddaren ökar risken för elektrisk stöt.
- ▶ **Ladda inte batterimoduler av främmande fabrikat.** Laddaren är lämplig endast för laddning av Bosch lijonbatterimoduler med den spänning som anges i Tekniska data. I annat fall finns risk för brand och explosion.
- ▶ **Håll laddaren ren.** Förorening kan leda till elektrisk stöt.
- ▶ **Kontrollera laddare, kabel och stickkontakt före varje användning. En skadad laddare får inte användas. Du får själv aldrig öppna laddaren, låt den repareras av kvalificerad fackman och endast med originalreservdelar.** Skadade laddare, ledningar eller stickkontakter ökar risken för elektrisk stöt.
- ▶ **Använd inte laddaren på lättantändligt underlag (t. ex. papper, textilier mm) resp. i brännbar omgivning.** Vid laddningen värms laddaren upp vilket kan medföra brandrisk.

Funktionsbeskrivning



Läs noga igenom alla anvisningar. Fel som uppstår till följd av att anvisningarna nedan inte följts kan orsaka elstöt, brand och/eller allvarliga kroppsskador.

Ändamålsenlig användning

Elverktyget är avsett för i- och urdragning av skruvar.

Använd elverktyget endast om du är förtrogen med dess funktioner och utan inskränkning behärskar hanteringen eller om du fått de anvisningar för manövrering som krävs.

Illustrerade komponenter

Numreringen av komponenterna hänvisar till illustration av elverktyget på grafiksida.

- 1 Skruvbits*
- 2 Verktygsfäste
- 3 Ställring för vridmomentsförval
- 4 Rotationsindikator högergång
- 5 Indikering av batterimodulens laddningstillstånd
- 6 Rotationsindikator vänstergång
- 7 Lampa "Power Light"
- 8 Strömställare Till/Från
- 9 Riktningssomkopplare
- 10 Laddare

***I bruksanvisningen avbildat och beskrivet tillbehör ingår inte i standardleveransen. I vårt tillbehörsprogram beskrivs allt tillbehör som finns.**

Tekniska data

Sladdlös skruvdragare		PSR 7,2 LI
Produktnummer		3 603 J57 7..
Märkspänning	V=	7,2
Tomgångsvarvtal	min ⁻¹	0–230
Max. vridmoment hårt/mjukt skruvförband enligt ISO 5393	Nm	10/6
max. skruv-Ø	mm	6
Vikt enligt EPTA-Procedure 01/2003	kg	0,5
Batterimodul		Li-jon
Kapacitet	Ah	1,3
Antal battericeller		2
Laddare		
Produktnummer		2 607 225 553 (EU) 2 607 225 555 (UK)
Laddningstid	h	5,0

Beakta produktnumret på elverktygets typskylt. Handelsbeteckningarna för enskilda elverktyg kan variera.



Buller-/vibrationsdata

Mätvärdena har bestämts baserande på EN 60745.

Elverktygets A-vägda ljudtrycksnivå är i typiska fall mindre än 70 dB(A). Onoggrannhet K = 3 dB.

Ljudnivån kan vid arbeten överskrida 80 dB(A).

Använd hörselskydd!

Totala vibrationsvärden (vektorsumma ur tre riktningar) framtaget enligt EN 60745:

skruvdragning: Vibrationsemissionsvärde $a_h < 2,5 \text{ m/s}^2$, onoggrannhet K = $1,5 \text{ m/s}^2$.

Mätningen av den vibrationsnivå som anges i denna anvisning har utförts enligt en mätmetod som är standardiserad i EN 60745 och kan användas vid jämförelse av olika elverktyg. Mätmetoden är även lämplig för preliminär bedömning av vibrationsbelastningen.

Den angivna vibrationsnivån representerar den huvudsakliga användningen av elverktyget. Om däremot elverktyget används för andra ändamål och med andra insatsverktyg eller inte underhållits ordentligt kan vibrationsnivån avvika. Härvid kan vibrationsbelastningen under arbetsperioden öka betydligt.

För en exakt bedömning av vibrationsbelastningen bör även de tider beaktas när elverktyget är frånkopplat eller är igång men inte används. Detta reducerar tydligt vibrationsbelastningen för den totala arbetsperioden.

Bestäm extra säkerhetsåtgärder för att skydda operatören mot vibrationernas inverkan t.ex.: underhåll av elverktyget och insatsverktygen, att hålla händerna varma, organisation av arbetsförloppen.

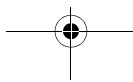
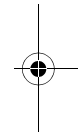
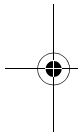

Försäkran om överensstämmelse

Vi försäkrar härmed under exklusivt ansvar att denna produkt som beskrivs i "Tekniska data" överensstämmer med följande normer och normativa dokument: EN 60745 (sladdlösa verktyg) resp EN 60335 (batteriladdare) enligt bestämmelserna i direktiven 2006/95/EG, 2004/108/EG, 98/37/EG (till 28.12.2009), 2006/42/EG (from 29.12.2009).

Teknisk tillverkningsdokumentation finns hos:
Robert Bosch GmbH, PT/ESC,
D-70745 Leinfelden-Echterdingen

 08

Dr. Egbert Schneider Senior Vice President Engineering	Dr. Eckerhard Strötgen Head of Product Certification
--	--

Dr. Egbert Schneider *Dr. Eckerhard Strötgen*

Robert Bosch GmbH, Power Tools Division
D-70745 Leinfelden-Echterdingen
16.09.2008

Montage

Batteriets laddning (se bild A)

- **Använd inte andra laddare.** Den medlevererade laddaren är anpassad till det li-jonbatteri som är monterat i elverktyget.

178 | Svenska

- ▶ **Beakta nätspänningen!** Kontrollera att strömkällans spänning överensstämmer med uppgifterna på laddarens typskylt. Laddare märkta med 230 V kan även anslutas till 220 V.

Anvisning: Batterimodulen levereras ofullständigt uppladdad. För full effekt ska batterimodulen före första användningen laddas upp i laddaren.

Litium-jonbatteriet kan när som helst laddas upp eftersom detta inte påverkar livslängden. Batteriet skadas inte om laddning avbryts.

Litium-jonbatteriet är med "Electronic Cell Protection (ECP)" skyddad mot djupurladdning. Vid urladdat batteri kopplar skyddskopplingen från elverktyget: Insatsverktyget roterar inte längre.

⚠ OBS Undvik att trycka på strömställaren Till/Från efter en automatisk frånkoppling av elverktyget. Batteriet kan skadas.

Laddningen startar när laddarens stickpropp ansluts till nätuttaget och den sladdlösa skruvdragaren placeras på laddaren **10**.

Batteriladdningsindikatorn **5** visar hur laddningen fortskrider. Under laddning **blinkar** indikatorn med grönt ljus. Batterimodulen är fullständigt uppladdad när indikatorn **permanent** lyser med grönt ljus.

Under laddning blir elverktygets handtag varmt. Detta är normalt.

Koppla från nätströmmen till laddaren om den inte ska användas under en längre tid.

Elverktyget kan under uppladdning inte användas; dvs. batteriet är inte defekt även om det inte fungerar under uppladdning.

Beakta anvisningarna för avfallshantering.

Verktogsbyte (se bild B)

- ▶ **Innan åtgärder utförs på elverkytet (t. ex. underhåll, verktygsbyte osv) och för transport och lagring ställ riktningsskopplaren i mittläge.** Om strömställaren Till/Från oavsiktligt påverkas finns risk för kroppsskada.
- ▶ **Använd inte tvåsidiga skruvbits som är längre än 25 mm.**

Skjut in skruvbitsen **1** direkt i verktygsfästet **2**.

Drift

Driftstart

Inställning av rotationsriktning (se bild C)

Med riktningsskopplaren **9** kan elverkygets rotationsriktning ändras. Vid nedtryckt strömställare Till/Från **8** kan omkoppling inte ske.

Högergång: För idragning av skruvar tryck riktningsskopplaren **9** åt vänster mot stopp.

 Rotationsindikatorn högergång **4** lyser när strömställaren Till/Från **8** påverkats och motorn är igång.

Vänstergång: För lossning och urdragning av skruvar tryck riktningsskopplaren **9** åt höger mot stopp.

 Rotationsindikatorn vänstergång **6** lyser när strömställaren Till/Från **8** påverkats och motorn är igång.



Förval av vridmoment

Med ställringen för vridmomentförval **3** kan det vridmoment som behövs väljas i 10 steg. När det inställda vridmomentet uppnås stoppas insatsverktyget.

Steg 1:

Lågt vridmoment för idragning av skruvar med liten diameter eller i mjukt material.

Steg 10:

Högre vridmoment för idragning av skruvar med stor diameter eller i hårt material.

In- och urkoppling

Tryck för **start** av elverktyget ned strömställaren Till/Från **8** och håll den nedtryckt.

Lampan **7** lyser vid lätt eller helt nedtryckt strömställare **8** och belyser arbetsområdet vid ogynnsamma belysningsförhållanden.

För **frånkoppling** av elverktyget släpp strömställaren Till/Från **8**.

Inställning av varvtalet

Varvtalet på inkopplat elverktyg kan justeras steglöst genom att mer eller mindre trycka ned strömställaren Till/Från **8**.

Ett lätt tryck på strömställaren Till/Från **8** ger ett lågt varvtalet. Med tilltagande tryck ökar varvtalet.

Helautomatisk spindellåsning (Auto-Lock)

Vid opåverkad strömställare Till/Från **8** är borrarspindeln och även verktygsfästet låsta.

Detta möjliggör idragning av skruvar även om batteriet är förbrukat, dvs verktyget kan användas som en normal skruvdragare.

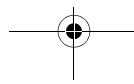
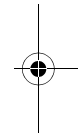
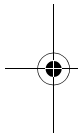

Temperaturberoende överbelastningsskydd

Om elverktyget används på ändamålsenligt sätt kan det inte överbelastas. Vid för kraftig belastning eller om tillåten batteritemperatur på 70 °C överskrids, kopplar elektroniken bort elverktyget tills det åter uppnått optimal drifttemperatur.

Djupurladdningsskydd

Litium-jonbatteriet är med "Electronic Cell Protection (ECP)" skyddad mot djupurladdning. Vid urladdat batteri kopplar skyddskopplingen från elverktyget: Insatsverktyget roterar inte längre.

Arbetsanvisningar

- **Elverktyget ska vara fränkopplat när det förs mot skruven.** Roterande einsatsverktyg kan slira bort.

Underhåll och service

Underhåll och rengöring

- **Innan åtgärder utförs på elverktyget (t. ex. underhåll, verktygsbyte osv) och för transport och lagring ställ riktningssomkopplaren i mittläge.** Om strömställaren Till/Från oavsiktligt påverkas finns risk för kroppsskada.
- **Håll elverktyget och dess ventilationsöppningar rena för bra och säkert arbete.**



182 | Svenska



Kontakta en auktoriserad serviceverkstad för Bosch-elverktyg när batterimodulen inte längre är funktionsduglig.

Om i elverktyget trots exakt tillverkning och sträng kontroll störning skulle uppstå, bör reparation utföras av auktoriserad serviceverkstad för Bosch elverktyg.

Ange alltid vid förfrågningar och reservdelsbeställningar det 10-siffriga produktnumret som finns på elverktygets typskylt.

Kundservice och kundkonsulter

Kundservicen ger svar på frågor beträffande reparation och underhåll av produkter och reservdelar. Sprängskissar och informationer om reservdelar lämnas även på adressen:

www.bosch-pt.com

Bosch kundkonsultgruppen hjälper gärna när det gäller frågor beträffande köp, användning och inställning av produkter och tillbehör.

Svenska

Bosch Service Center
Telegrafvej 3
2750 Ballerup
Danmark
Tel.: +46 (020) 41 44 55
Fax: +46 (011) 18 76 91

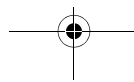
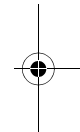
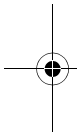

Transport

Batterimodulen har testats enligt UN-handboken ST/SG/AC.10/11/rev.3 del III, underavsnitt 38.3. Den är effektivt skyddad mot inre övertryck och kortslutning samt har anordningar för att förhindra brott genom återkan och farlig returström.

Den i batterimodulen ingående litiumekvivalentmängden ligger under tillämpliga gränsvärden. För batterimodulen som separat del eller insatt i ett verktyg gäller därför varken nationella eller internationella föreskrifter avseende farligt gods. Föreskrifterna för farligt gods kan dock gälla vid transport av flera batterimoduler. I detta fall kan det vara nödvändigt att uppfylla vissa villkor (t.ex. beträffande förpackning). Ytterligare detaljer lämnas i ett informationsblad med följande internetadress:

<http://purchasing.bosch.com/en/start/Allgemeines/Download/index.htm>.

Avfallshantering

Elverktyg, tillbehör och förpackning ska omhändertas på miljövänligt sätt för återvinning.

Endast för EU-länder:



Släng inte elverktyg i hushållsavfall!
Enligt europeiska direktivet 2002/96/EG för kasserade elektriska och elektroniska apparater och dess modifiering till nationell rätt måste obrukbara elverktyg omhändertas separat och på miljövänligt sätt lämnas in för återvinning.

Sekundär-/primärbatterier:



Li-jon:

Beakta anvisningarna i avsnittet "Transport", sida 183.

Förbrukade batterier får inte slängas i hushållsavfall och inte heller i eld eller vatten. Batterierna ska samlas för återvinning eller omhändertas på miljövänligt sätt.

Endast för EU-länder:

Defekta eller förbrukade batterier måste enligt direktivet 91/157/EEG omhändertas för återvinning.

Aktivera, när elverktygets batterimodul skall tas bort, strömställaren Till/Från **8** tills batteriet är fullständigt urladdat. Skruva loss skruvarna på huset och ta bort huskalet. Lossa batterimodulens anslutningar och ta ut batterimodulen.

Ändringar förbehålles.

Sikkerhetsinformasjon

Generelle advarsler for elektroverktøy

⚠ ADVARSEL Les gjennom alle advarslene og anvisningene. Feil ved overholdelsen av advarslene og nedenstående anvisninger kan medføre elektriske støt, brann og/eller alvorlige skader.

Ta godt vare på alle advarslene og informasjonene.

Det nedenstående anvendte uttrykket «elektroverktøy» gjelder for strømdrevne elektroverktøy (med ledning) og batteridrevne elektroverktøy (uten ledning).

1) Sikkerhet på arbeidsplassen

- a) **Hold arbeidsområdet rent og ryddig og sørg for bra belysning.** Rotete arbeidsområder eller arbeidsområder uten lys kan føre til ulykker.
- b) **Ikke arbeid med elektroverktøyet i eksplosjonsut-satte omgivelser – der det befinner seg brennbare væsker, gass eller støv.** Elektroverktøy lager gnister som kan antenne støv eller damper.
- c) **Hold barn og andre personer unna når elektroverktøyet brukes.** Hvis du blir forstyrret under arbeidet, kan du miste kontrollen over elektroverktøyet.

2) Elektrisk sikkerhet

- a) **Støpselet til elektroverktøyet må passe inn i stikkontakten. Støpselet må ikke forandres på noen som helst måte. Ikke bruk adapterstøpsler sammen med jordede elektroverktøy.** Bruk av støpsler som ikke er forandret på og passende stikkontakter reduserer risikoen for elektriske støt.

b) Unngå kroppskontakt med jordede overflater slik som rør, ovner, komfyrer og kjøleskap. Det er større fare ved elektriske støt hvis kroppen din er jordet.

c) Hold elektroverktøyet unna regn eller fuktighet. Dersom det kommer vann i et elektroverktøy, øker risikoen for elektriske støt.

d) Ikke bruk ledningen til andre formål, f. eks. til å bære elektroverktøyet, henge det opp eller trekke det ut av stikkontakten. Hold ledningen unna varme, olje, skarpe kanter eller verktøydeler som beveger seg. Med skadede eller opphopede ledninger øker risikoen for elektriske støt.

e) Når du arbeider utendørs med et elektroverktøy, må du kun bruke en skjøteledning som er egnet til utendørs bruk. Når du bruker en skjøteledning som er egnet for utendørs bruk, reduseres risikoen for elektriske støt.

f) Hvis det ikke kan unngås å bruke elektroverktøyet i fuktige omgivelser, må du bruke en jordfeilbryter. Bruk av en jordfeilbryter reduserer risikoen for elektriske støt.

3) Personsikkerhet

a) Vær oppmerksom, pass på hva du gjør, gå fornuftig frem når du arbeider med et elektroverktøy. Ikke bruk elektroverktøy når du er trett eller er påvirket av narkotika, alkohol eller medikamenter. Et øyeblikks uoppmerksomhet ved bruk av elektroverktøyet kan føre til alvorlige skader.

b) Bruk personlig verneutstyr og husk alltid å bruke vernebriller. Bruk av personlig sikkerhetsutstyr som støvmaske, sklifaste arbeidssko, hjelm eller hørselvern – avhengig av type og bruk av elektroverktøyet – reduserer risikoen for skader.

c) Unngå å starte verktøyet ved en feiltagelse. Forviss deg om at elektroverktøyet er slått av før du kobler det til strømmen og/eller batteriet, løfter det opp eller bærer det. Hvis du holder fingeren på bryteren når du bærer elektroverktøyet eller kobler elektroverktøyet til strømmen i innkoblet tilstand, kan dette føre til uhell.

d) Fjern innstillingsverktøy eller skrunøkler før du slår på elektroverktøyet. Et verktøy eller en nøkkel som befinner seg i en roterende verktøydell, kan føre til skader.

e) Unngå en unormal kroppsholdning. Sørg for å stå stødig og i balanse. Dermed kan du kontrollere elektroverktøyet bedre i uventede situasjoner.

f) Bruk alltid egnede klær. Ikke bruk vide klær eller smykker. Hold hår, tøy og hansker unna deler som beveger seg. Løstsittende tøy, smykker eller langt hår kan komme inn i deler som beveger seg.

g) Hvis det kan monteres støvavsug- og oppsamlingsinnretninger, må du forvise deg om at disse er tilkoblet og brukes på korrekt måte. Bruk av et støvavsug reduserer farer på grunn av støv.

4) Omhyggelig bruk og håndtering av elektroverktøy**a) Ikke overbelast verktøyet. Bruk et elektroverktøy som er beregnet til den type arbeid du vil utføre.**

Med et passende elektroverktøy arbeider du bedre og sikrere i det angitte effektområdet.

b) Ikke bruk elektroverktøy med defekt på-/av-bryter. Et elektroverktøy som ikke lenger kan slås av eller på, er farlig og må repareres.**c) Trekk støpselet ut av stikkontakten og/eller fjern batteriet før du utfører innstillinger på elektroverktøyet, skifter tilbehørsdeler eller legger maskinen bort. Disse tiltakene forhindrer en utilsiktet start av elektroverktøyet.****d) Elektroverktøy som ikke er i bruk må oppbevares utilgjengelig for barn. Ikke la maskinen brukes av personer som ikke er fortrolig med dette eller ikke har lest disse anvisningene. Elektroverktøy er farlige når de brukes av uerfarne personer.****e) Vær nøye med vedlikeholdet av elektroverktøyet. Kontroller om bevegelige verktøydeler fungerer feilfritt og ikke klemmes fast, og om deler er bruket eller skadet, slik at dette innvirker på elektroverktøyets funksjon. La disse skadede delene repareres før elektroverktøyet brukes. Dårlig vedlikeholdte elektroverktøy er årsaken til mange uhell.****f) Hold skjæreverktøyene skarpe og rene. Godt stelte skjæreverktøy med skarpe skjær setter seg ikke så ofte fast og er lettere å føre.**

g) Bruk elektroverktøy, tilbehør, verktøy osv. i henhold til disse anvisningene. Ta hensyn til arbeidsforholdene og arbeidet som skal utføres. Bruk av elektroverktøy til andre formål enn det som er angitt kan føre til farlige situasjoner.

5) Omhyggelig bruk og håndtering av batteridrevne verktøy

- a) Lad batteriet kun opp i ladeapparater som er anbefalt av produsenten.** Det oppstår brannfare hvis et ladeapparat som er egnet til en bestemt type batterier, brukes med andre batterier.
- b) Bruk derfor kun riktig type batterier for elektroverktøyene.** Bruk av andre batterier kan medføre skader og brannfare.
- c) Hold batteriet som ikke er i bruk unna binders, mynter, nøkler, spikre, skruer eller andre mindre metallgjenstander, som kan lage en forbindelse mellom kontaktene.** En kortslutning mellom batterikontaktene kan føre til forbrenninger eller brann.
- d) Ved gal bruk kan det lekke væske ut av batteriet. Unngå kontakt med denne væsken. Ved tilfeldig kontakt må det skylles med vann. Hvis det kommer væske i øynene, må du i tillegg oppsøke en lege.** Batterivæske som renner ut kan føre til irritasjoner på huden eller forbrenninger.

6) Service

- a) Elektroverktøyet ditt skal alltid kun repareres av kvalifisert fagpersonale og kun med originale reservedeler.** Slik opprettholdes verktøyets sikkerhet.

Sikkerhetsinformasjoner for skrutrekkere

- ▶ **Hold elektroverktøyet på de isolerte gripeflatene, hvis du utfører arbeid der skruen kan treffe på skjulte strømløsningsledninger.** Kontakt mellom skruen og en spenningsførende ledning kan også sette elektroverktøyet metalldele under spenning og føre til elektriske støt.
- ▶ **Hold elektroverktøyet godt fast.** Ved tiltrekking eller løsning av skruer kan det ett øyeblikk oppstå høye reaksjonsmomenter.
- ▶ **Sikre arbeidsstykket.** Et arbeidsstykke som holdes fast med spenningsretninger eller en skrustikke, holdes sikrere enn med hånden.
- ▶ **Sett høyre-/venstre-bryteren i midtstilling før alle arbeider på elektroverktøyet utføres (f. eks. vedlikehold, verktøyskifte osv.) og når den transporteres eller lagres.** Det er ellers fare for skader hvis du trykker på på-/av-bryteren ved en feiltagelse.
- ▶ **Unngå en uvilkårlig innkopling. Forviss deg om at på-/av-bryteren er i utkopletposisjon før du setter inn et batteri.** Hvis du bærer elektroverktøyet med fingeren på på-/av-bryteren eller setter batteriet inn i et innkoplett elektroverktøy kan det føre til uhell.
- ▶ **Batteriet må ikke åpnes.** Det er fare for kortslutning.



Beskytt el-verktøyet mot varme, f. eks. også mot permanent solinnvirkning, og ild. Det er fare for eksplosjoner.

- ▶ **Ved skader og usakkyndig bruk av batteriet kan det slippe ut damp. Tilfør frisk luft og gå til lege hvis det oppstår helseproblemer.** Dampene kan irritere åndretnsorganene.
- ▶ **Ved defekt batteri kan det lekke ut væske som fukter gjenstander i nærheten. Sjekk de aktuelle delene.** Rengjør disse eller bytt dem eventuelt ut.

Sikkerhetsinformasjoner for ladeapparater



Hold ladeapparatet unna regn eller fuktighet. Dersom det kommer vann i et ladeapparat, øker risikoen for elektriske støt.

- ▶ **Ikke lad opp oppladbare batterier fra andre produsenter.** Ladeapparatet er kun egnet til opplading av Bosch li-ion-batterier med spenninger som angitt i Tekniske data. Ellers er det fare for brann og eksplosjoner.
- ▶ **Hold ladeapparatet rent.** Smuss fører til fare for elektriske støt.
- ▶ **Før hver bruk må du kontrollere ladeapparatet, ledningen og støpselet. Ikke bruk ladeapparatet hvis du registrerer skader. Du må ikke åpne ladeapparatet selv og la det alltid kun repareres av kvalifisert fagpersonale og kun med originale reservedeler.** Skadet ladeapparat, ledning og støpsel øker risikoen for elektriske støt.
- ▶ **Ikke bruk ladeapparatet på lett brennbar undergrunn (f. eks. papir, tekstiler etc.) eller i brennbare omgivelser.** Ladeapparatet oppvarmes under oppladingen og det er derfor fare for brann.



Funksjonsbeskrivelse



Les gjennom alle advarslene og anvisningene. Feil ved overholdelsen av advarslene og nedenstående anvisninger kan medføre elektriske støt, brann og/eller alvorlige skader.

Formålmessig bruk

Maskinen er beregnet til inn- og utskruing av skruer.

Bruk elektroverktøyet kun hvis du kan beregne alle funksjonene og kan utføre disse uten innskrenkninger eller har fått tilsvarende instruksjer.

Illustrerte komponenter

Nummereringen av de illustrerte komponentene gjelder for bildet av elektroverktøyet på illustrasjonssiden.

- 1 Skrubits*
- 2 Verktøyfeste
- 3 Innstillingsring for dreiemomentforvalg
- 4 Dreieretningsanvisning for høyregang
- 5 Batteri-ladetilstandsindikator
- 6 Dreieretningsanvisning for venstregang
- 7 Lampen «Power Light»
- 8 På-/av-bryter
- 9 Høyre-/venstrebryter
- 10 Ladeapparat

***Illustrert eller beskrevet tilbehør inngår ikke i standard-leveransen. Det komplette tilbehøret finner du i vårt tilbehørsprogram.**

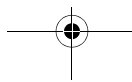
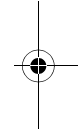
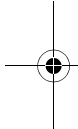

Norsk | 193

Tekniske data

Akku-skrutrekker		PSR 7,2 LI
Produktnummer		3 603 J57 7..
Nominell spenning	V=	7,2
Tomgangsturtall	min ⁻¹	0–230
Max. dreiemoment for hard/myk skruing jf. ISO 5393	Nm	10/6
max. skrue-Ø	mm	6
Vekt tilsvarende EPTA-Procedure 01/2003	kg	0,5
Batteri		Li-ioner
Kapasitet	Ah	1,3
Antall battericeller		2
Ladeapparat		
Produktnummer		2 607 225 553 (EU) 2 607 225 555 (UK)
Oppladingstid	h	5,0

Legg merke til produktnummeret på typeskiltet til elektroverktøyet ditt. Handelsbetegnelsene for de enkelte elektroverktøyene kan variere.



Støy-/vibrasjonsinformasjon

Måleverdier funnet i henhold til EN 60745.

Det typiske A-bedømte lydtryknivået for elektroverktøyet er mindre enn 70 dB(A). Usikkerhet K = 3 dB.

Støynivået kan i løpet av arbeidet overskride 80 dB(A).

Bruk hørselvern!

Totale svingningsverdier (vektorsum fra tre retninger) beregnet jf. EN 60745:

Skruing: Svingningsemisjonsverdi $a_h < 2,5 \text{ m/s}^2$, usikkerhet K = $1,5 \text{ m/s}^2$.

Vibrasjonsnivået som er angitt i disse anvisningene er målt iht. en målemetode som er standardisert i EN 60745 og kan brukes til sammenligning av elektroverktøy med hverandre. Den egner seg til en foreløbig vurdering av svingningsbelastningen.

Det angitte svingningsnivået representerer de hovedsakelige anvendelsene til elektroverktøyet. Men hvis elektroverktøyet brukes til andre anvendelser, med avvikende innsatsverktøy eller utilstrekkelig vedlikehold, kan svingningsnivået avvike. Dette kan føre til en tydelig øking av svingningsbelastningen over hele arbeidstidsrommet.

Til en nøyaktig vurdering av svingningsbelastningen skal det også tas hensyn til de tidene maskinen er slått av eller går, men ikke virkelig brukes. Dette kan tydelig redusere svingningsbelastningen over hele arbeidstidsrommet.

Bestem ekstra sikkerhetstiltak til beskyttelse av brukeren mot svingningenes virkning, som for eksempel: Vedlikehold av elektroverktøy og innsatsverktøy, holde hendene varme, organisere arbeidsforløpene.

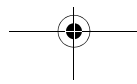
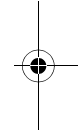
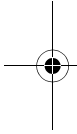



Samsvarserklæring

Vi erklærer som eneansvarlig at produktet som beskrives under «Tekniske data» stemmer overens med følgende normer eller normative dokumenter: EN 60745 (akku-redskap) hhv. EN 60335 (akku-ladere) jf. bestemmelsene i direktivene 2006/95/EF, 2004/108/EF, 98/37/EF (frem til 28.12.2009), 2006/42/EF (fra 29.12.2009).

Tekniske underlag hos:
Robert Bosch GmbH, PT/ESC,
D-70745 Leinfelden-Echterdingen

 08

Dr. Egbert Schneider Senior Vice President Engineering	Dr. Eckerhard Strötgen Head of Product Certification
--	--

Robert Bosch GmbH, Power Tools Division
D-70745 Leinfelden-Echterdingen
16.09.2008

Montering

Opplading av batteriet (se bilde A)

- **Ikke bruk et annet ladeapparat.** Det medleverte ladeapparatet er tilpasset til Li-ion-batteriet som er innebygget i elektroverktøyet.

- **Ta hensyn til strømspenningen!** Spenningen til strømkilden må stemme overens med angivelsene på ladeapparatets typeskilt. Ladeapparater som er merket med 230 V kan også brukes med 220 V.

Merk: Batteriet leveres delvis oppladet. For å sikre full effekt fra batteriet, må du lade det fullstendig opp i ladeapparatet før førstegangs bruk.

Litium-ion-batteriet kan lades opp til enhver tid uten at levetiden forkortes. Det skader ikke batteriet å avbryte oppladingen.

Litium-ion-batteriet er beskyttet av «Electronic Cell Protection (ECP)» mot total utlading. Når batteriet er utladet, kobles elektroverktøyet ut med en beskyttelseskobling: Innsatsverktøyet beveger seg ikke lenger.

⚠ OBS Trykk etter automatisk utkobling av elektroverktøyet ikke videre på på-/ av-bryteren. Batteriet kan ta skade.

Oppladingen begynner med en gang nettstøpselet til ladeapparatet settes inn i stikkkontakten og batteriskruetrekkeren deretter settes på ladeapparatet **10**.

Batteri-ladetilstandsindikatoren **5** viser hvor langt oppladingen er kommet. Ved opplading **blinker** meldingen grønt. Batteriet er fullt oppladet når meldingen lyser **kontinuerlig** grønt.

Under oppladingen oppvarmes håndtaket på elektroverktøyet. Dette er normalt.

Når ladeapparatet ikke er i bruk over lengre tid må det adskilles fra strømnettet.

Elektroverktøyet kan ikke brukes under opplading; det er ikke defekt hvis det ikke fungerer i løpet av oppladingen.

Følg informasjonene om kassering.

Verktøyskifte (se bilde B)

- ▶ **Sett høyre-/venstre-bryteren i midtstilling før alle arbeider på elektroverktøyet utføres (f. eks. vedlikehold, verktøyskifte osv.) og når den transporteres eller lagres.** Det er ellers fare for skader hvis du trykker på på-/av-bryteren ved en feiltagelse.
- ▶ **Ikke bruk skrutrekkerklinger med 2 sider som er lengre enn 25 mm.**

Sett skrubitsen **1** direkte inn i verktøyfestet **2**.

Bruk

Igangsetting

Innstilling av rotasjonsretningen (se bilde C)

Med høyre-/venstre-bryteren **9** kan du endre dreieretningen til elektroverktøyet. Ved trykt på-/av-bryter **8** er dette ikke mulig.

Høyregang: Til innskruing av skruer trykker du høyre-/venstre-bryteren **9** helt inn mot venstre.

 Dreieretningsindikatoren for høyregang **4** lyser ved trykt på-/av-bryter **8** og når motoren går.

Venstregang: Til løsning hhv. utskruing av skruer trykker du høyre-/venstre-bryteren **9** helt inn mot høyre.

 Dreieretningsindikatoren for venstregang **6** lyser ved trykt på-/av-bryter **8** og når motoren går.



Forvalg av dreiemoment

Med innstillingsringen for dreiemomentforvalg **3** kan du forhåndsinnstille det nødvendige dreiemomentet i 10 trinn. Så snart det innstilte dreiemomentet er nådd, stanses innsatsverktøyet.

Trinn 1:

Mindre dreiemoment til innskruing av skruer med mindre diameter eller i myke materialer.

Trinn 10:

Større dreiemoment til innskruing av skruer med større diameter eller i harde materialer.

Inn-/utkobling

Trykk til **igangsetting** av elektroverktøyet på på-/av-bryteren **8** og hold den trykt inne.

Lampen **7** lyser ved litt eller helt inntrykket på-/av-bryter **8** og muliggjør opplysning av arbeidsområdet ved ugunstige lysforhold.

Til **utkobling** av elektroverktøyet slipper du på-/av-bryteren **8**.

Innstilling av turtallet

Du kan innstille turtallet på innkoplet elektroverktøy trinnløst, avhengig av hvor langt du trykker på-/av-bryteren **8** inn.

Et svakt trykk på på-/av-bryteren **8** fører til et lavt turtall. Turtallet økes med økende trykk.

Helautomatisk spindellås (Auto-Lock)

Ved ikke trykt på-/av-bryter **8** låses borespindelen og verktøyholderen låses.

Dette muliggjør en innskruing av skruer også når batteriet er utladet hhv. hvis elektroverktøyet brukes som skrutrekker.

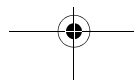
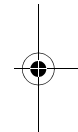
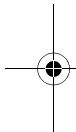

Temperaturavhengig overlastbeskyttelse

Ved formålmessig bruk kan elektroverktøyet ikke overbelastes. Ved for sterk belastning eller overskridelse av godkjent batteri-temperatur på 70 °C kobler elektronikken ut elektroverktøyet, til det igjen er i optimal driftstemperaturområde.

Beskyttelse mot total utlading

Litium-ion-batteriet er beskyttet av «Electronic Cell Protection (ECP)» mot total utlading. Når batteriet er utladet, kobles elektroverktøyet ut med en beskyttelseskobling: Innsatsverktøyet beveger seg ikke lenger.

Arbeidshenvisninger

- ▶ **Sett elektroverktøyet bare på skruen når det er slått av.** Innsatsverktøy som dreier seg kan skli.

Service og vedlikehold

Vedlikehold og rengjøring

- ▶ **Sett høyre-/venstre-bryteren i midtstilling før alle arbeider på elektroverktøyet utføres (f. eks. vedlikehold, verktøyskifte osv.) og når den transporteres eller lagres.** Det er ellers fare for skader hvis du trykker på på-/av-bryteren ved en feiltagelse.
- ▶ **Hold elektroverktøyet og ventilasjonsspaltene alltid rene, for å kunne arbeide bra og sikkert.**



200 | Norsk



Hvis batteriet ikke lenger er funksjonsdyktig, må du henvende deg til en autorisert kundeservice for Bosch-elektroverktøy.

Hvis elektroverktøyet til tross for omhyggelige produktions- og kontrollmetoder en gang skulle svikte, må reparasjonen utføres av et autorisert serviceverksted for Bosch-elektroverktøy.

Ved alle forespørsler og reservedelsbestillinger må du oppgi det 10-sifrede produktnummeret som er angitt på elektroverktøyets typeskilt.

Kundeservice og kunderådgivning

Kundeservice hjelper deg ved spørsmål om reparasjon og vedlikehold av produktet ditt og reservedelene. Deltagninger og informasjonen om reservedeler finner du også under:

www.bosch-pt.com

Bosch-kunderådgiver-teamet er gjerne til hjelp ved spørsmål om kjøp, bruk og innstilling av produkter og tilbehør.

Norsk

Robert Bosch AS
Postboks 350
1402 Ski
Tel: + 47 (6487) 89 50
Faks: + 47 (6487) 89 55

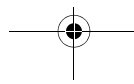
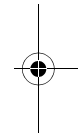
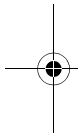

Transport

Batteriet er testet jf. UN-håndbok ST/SG/AC.10/11/Rev.3 del III, underavsnitt 38.3. Det har en virksom beskyttelse mot indre overtrykk og kortslutning samt innretninger til forhindring av brudd etter vold og farlig tilbakestrøm. Litiumekvivalent-mengden som finnes i batteriet er under vanlig grenseverdi. Derfor gjelder de nasjonale og internasjonale forskriftene for farlig gods verken for batteriet som enkelt del eller innsatt i elektroverktøyet. Men forskriftene for farlig gods kan være relevant ved transport av flere batterier. Det kan i dette tilfellet være nødvendig å overholde spesielle vilkår (f. eks. med emballasjen). Nærmere informasjon får du i en engelsk informasjon under følgende internetadresse:
<http://purchasing.bosch.com/en/start/Allgemeines/Download/index.htm>.

Deponering

Elektroverktøy, tilbehør og emballasje må leveres inn til miljøvennlig gjenvinning.

Kun for EU-land:



Ikke kast elektroverktøy i vanlig søppel! Jf. det europeiske direktivet 2002/96/EF vedr. gamle elektriske og elektroniske apparater og tilpassingen til nasjonale lover må gammelt elektroverktøy som ikke lenger kan brukes samles inn og leveres inn til en miljøvennlig resirkulering.

Batterier/oppladbare batterier:



Li-ion:

Ta hensyn til informasjonene i avsnittet «Transport», side 201.

Ikke kast batterier i vanlig søppel, ild eller vann. Batterier skal samles inn, resirkuleres eller deponeres på en miljøvennlig måte.

Kun for EU-land:

Defekte eller oppbrukte batterier må resirkuleres iht. direktiv 91/157/EØF.

For å ta batteriet ut av elektroverktøyet, trykker du på-/avbryteren **B** helt til batteriet er helt utladet. Skru skruene på huset ut og ta av selve huset. Adskill koblingene på batteriet og ta batteriet ut.

Retten til endringer forbeholdes.

Turvallisuusohjeita

Sähkötyökalujen yleiset turvallisuusohjeet

VAROITUS Lue kaikki turvallisuus- ja muut ohjeet. Turvallisuusohjeiden noudattamisen laiminlyönti saattaa johtaa sähköiskuun, tulipaloon ja/tai vakavaan loukkaantumiseen.

Säilytä kaikki turvallisuus- ja muut ohjeet tulevaisuutta varten.

Turvallisuusohjeissa käytetty käsite ”sähkötyökalu” käsittää verkkokäyttöisiä sähkötyökaluja (verkkojohdolla) ja akkukäyttöisiä sähkötyökaluja (ilman verkkojohtoa).

1) Työpaikan turvallisuus

- a) **Pidä työskentelyalue puhtaana ja hyvin valaistuna.** Työpaikan epäjärjestys tai valaisemattomat työalueet voivat johtaa tapaturmiin.
- b) **Älä työskentele sähkötyökalulla räjähdysalttiissa ympäristössä, jossa on palavaa nestettä, kaasua tai pölyä.** Sähkötyökalu muodostaa kipinöitä, jotka saattavat sytyttää pölyn tai höyryt.
- c) **Pidä lapset ja sivulliset loitolla sähkötyökalua käyttäessäsi.** Voit menettää laitteesi hallinnan, huomiosi suuntautuessa muualle.

2) Sähköturvallisuus

- a) **Sähkötyökalun pistotulpan tulee sopia pistorasiaan. Pistotulppaa ei saa muuttaa millään tavalla. Älä käytä mitään pistorasia-adaptoreita maadoitettujen sähkötyökalujen kanssa.** Alkuperäisessä kunnossa olevat pistotulpat ja sopivat pistorasiat vähentävät sähköiskun vaaraa.

**204 | Suomi**

- b) Vältä koskettamasta maadoitettuja pintoja, kuten putkia, pattereita, liesiä tai jääkaappeja.** Sähköiskun vaara kasvaa, jos kehosi on maadoitettu.
- c) Älä aseta sähkötyökalua alttiiksi sateelle tai kosteudelle.** Veden tunkeutuminen sähkötyökalun sisään kasvattaa sähköiskun riskiä.
- d) Älä käytä verkkojohtoa väärin. Älä käytä sitä sähkötyökalun kantamiseen, ripustamiseen tai pistotulpan irrottamiseen pistorasiasta vetämällä. Pidä johto loitolla kuumuudesta, öljystä, terävistä reunoista ja liikkuvista osista.** Vahingoittuneet tai sotkeutuneet johdot kasvattavat sähköiskun vaaraa.
- e) Käyttäessäsi sähkötyökalua ulkona, käytä ainoastaan ulkokäyttöön soveltuvaa jatkojohtoa.** Ulkokäyttöön soveltuvan jatkojohdon käyttö pienentää sähköiskun vaaraa.
- f) Jos sähkötyökalun käyttö kosteassa ympäristössä ei ole vältettävissä, tulee käyttää vikavirtasuojakytkintä.** Vikavirtasuojakytkimen käyttö vähentää sähköiskun vaaraa.

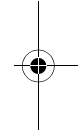
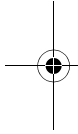
**3) Henkilöturvallisuus**

- a) Ole valpas, kiinnitä huomiota työskentelyysi ja noudata tervettä järkeä sähkötyökalua käyttäessäsi. Älä käytä mitään sähkötyökalua, jos olet väsynyt tai huumeiden, alkoholin tahi lääkkeiden vaikutuksen alaisena.** Hetken tarkkaamattomuus sähkötyökalua käytettäessä, saattaa johtaa vakavaan loukkaantumiseen.

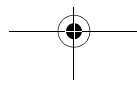

b) Käytä suojarusteita. Käytä aina suojalaseja.

Henkilökohtaisen suojarustuksen käyttö, kuten pölynaamarin, luistamattomien turvakenkien, suojakypärän tai kuulonsuojaimien, riippuen sähkötyökalun lajista ja käyttötavasta, vähentää loukaantumisriskiä.

c) Vältä tahatonta käynnistämistä. Varmista, että sähkötyökalu on poiskytkettyä, ennen kuin liität sen sähköverkkoon ja/tai liität akun, otat sen käteen tai kannat sitä. Jos kannat sähkötyökalua sormi käynnistyskytkimellä tai kytket sähkötyökalun pistotulpan pistorasiaan, käynnistyskytkimen ollessa käyntiasennossa, altistat itsesi onnettomuudelle.**d) Poista kaikki säätötyökalut ja ruuvitaltat, ennen kuin käynnistät sähkötyökalun.** Työkalu tai avain, joka sijaitsee laitteen pyörivässä osassa, saattaa johtaa loukkaantumiseen.**e) Vältä epänormaalia kehon asentoa. Huolehdi aina tukevasta seisoma-asennosta ja tasapainosta.** Täten voit paremmin hallita sähkötyökalua odottamattomissa tilanteissa.**f) Käytä tarkoitukseen soveltuvia vaatteita. Älä käytä löysiä työvaatteita tai koruja. Pidä hiukset, vaatteet ja käsineet loitolla liikkuvista osista.** Väljät vaatteet, korut ja pitkät hiukset voivat takertua liikkuviin osiin.**g) Jos pölynimu- ja keräilylaitteita voidaan asentaa, tulee sinun tarkistaa, että ne on liitetty ja että ne käytetään oikealla tavalla.** Pölynimulaitteiston käyttö vähentää pölyn aiheuttamia vaaroja.

4) Sähkötyökalujen huolellinen käyttö ja käsittely

- a) Älä ylikuormita laitetta. Käytä kyseiseen työhön tarkoitettua sähkötyökalua.** Sopivaa sähkötyökalua käyttäen työskentelet paremmin ja varmemmin tehoalueella, jolle sähkötyökalu on tarkoitettu.
- b) Älä käytä sähkötyökalua, jota ei voida käynnistää ja pysäyttää käynnistyskytkimestä.** Sähkötyökalu, jota ei enää voida käynnistää ja pysäyttää käynnistyskytkimellä, on vaarallinen ja se täytyy korjata.
- c) Irrota pistotulppa pistorasiasta, ennen kuin suoritat säätöjä, vaihdat tarvikkeita tai siirrät sähkötyökalun varastoitavaksi.** Nämä turvatoimenpiteet estävät sähkötyökalun tahattoman käynnistyksen.
- d) Säilytä sähkötyökalut poissa lasten ulottuvilta, kun niitä ei käytetä. Älä anna sellaisten henkilöiden käyttää sähkötyökalua, jotka eivät tunne sitä tai jotka eivät ole lukeneet tätä käyttöohjetta.** Sähkötyökalut ovat vaarallisia, jos niitä käyttävät kokemattomat henkilöt.
- e) Hoida sähkötyökalusi huolella. Tarkista, että liikkuvat osat toimivat moitteettomasti, eivätkä ole puristuksessa sekä, että siinä ei ole murtuneita tai vahingoittuneita osia, jotka saattaisivat vaikuttaa haitallisesti sähkötyökalun toimintaan. Anna korjata nämä vioittuneet osat ennen käyttöä.** Momen tapaturman syyt löytyvät huonosti huolletuista laitteista.
- f) Pidä leikkausterät terävinä ja puhtaina.** Huolellisesti hoidetut leikkaustyökalut, joiden leikkausreunat ovat teräviä, eivät tartu helposti kiinni ja niitä on helpompi hallita.

g) Käytä sähkötyökaluja, tarvikkeita, vaihtotyökaluja jne. näiden ohjeiden mukaisesti. Ota tällöin huomioon työolosuhteet ja suoritettava toimenpide.

Sähkötyökalun käyttö muuhun kuin sille määrättyyn käyttöön, saattaa johtaa vaarallisiin tilanteisiin.

5) Akkukäyttöisten työkalujen huolellinen käsittely ja käyttö

a) Lataa akku vain valmistajan suosittelemassa latauslaitteessa. Latauslaite, joka soveltuu määrätyn tyyppiselle akulle, saattaa muodostaa tulipalovaar-
an erilaista akkua ladattaessa.

b) Käytä sähkötyökalussa ainoastaan kyseiseen sähkötyökaluun tarkoitettua akkua. Jonkun muun akun käyttö saattaa johtaa loukkaantumiseen ja tulipaloon.

c) Pidä irrallista akkua loitolla metalliesineistä, kuten paperinliittimistä, kolikoista, avaimista, nauhoista, ruuveista tai muista pienistä metalliesineistä, jotka voivat oikosulkea akun koskettimet. Akkukoskettimien välinen oikosulku saattaa aiheuttaa palovammoja tai johtaa tulipaloon.

d) Väärästä käytöstä johtuen, akusta saattaa vuotaa nestettä. Vältä koskettamasta nestettä. Jos nestettä vahingossa joutuu iholle, huuhtelee kosketuskohta vedellä. Jos nestettä pääsee silmiin, tarvitaan tämän lisäksi lääkärin apua. Akusta vuotava neste saattaa aiheuttaa ärsytystä ja palovammoja.

6) Huolto

a) Anna ainoastaan koulutettujen ammattihenkilöiden korjata sähkötyökalusi ja hyväksy korjauksiin vain alkuperäisiä varaosia. Täten varmistat, että sähkötyökalu säilyy turvallisena.

Ruuvinvääntimien turvallisuusohjeet

- ▶ **Pidä sähkötyökalua eristetyistä pinnoista, tehdessäsi työtä, jossa ruuvi saattaisi osua piilossa olevaan sähköjohtoon.** Ruuvin kosketus jännitteeseen johtoon voi saattaa myös sähkötyökalun metalliosat jännitteiseksi ja johtaa sähköiskuun.
- ▶ **Pidä tukevasti kiinni sähkötyökalusta.** Ruuvia kiristettäessä ja avattaessa saattaa hetkellisesti syntyä voimakkaita vastamomentteja.
- ▶ **Varmista työkappale.** Kiinnityslaitteilla tai ruuvipenkissä kiinnitetty työkappale pysyy tukevammin paikoillaan, kuin kädessä pidettynä.
- ▶ **Aseta aina suunnanvaihtokytkin keskiasentoon ennen kaikkia laitteeseen kohdistuvia töitä (esim. huolto, työkalun vaihto jne.) sekä laitetta kuljetettaessa ja säilytettäessä.** Muutoin käynnistyskytkimen tahaton painallus muodostaa loukkaantumisvaaran.
- ▶ **Vältä käynnistämästä työkalua turhaan. Ennen kuin asetat akun paikalleen työkaluun, katso, että pääkytkin (ON/OFF) on kytketty pois päältä.** Jos työkalua kuljetetaan mukana niin, että se roikkuu pääkytkimen varassa tai jos akku asetetaan paikalleen virran ollessa päällä, seurauksena voi olla työtapaturma.
- ▶ **Älä avaa akkua.** On olemassa oikosulun vaara.



Suojaa sähkötyökalu kuumuudelta, esim. myös pitkäaikaiselta auringonpaisteelta ja tulelta.

On olemassa räjähdysvaara.

- ▶ **Jos akku vaurioituu tai sitä käytetään asiaankuulumattomalla tavalla, saattaa siitä purkautua höyryjä. Tuuleta raikkaalla ilmalla ja hakeudu lääkärin luo, jos ilmenee haittoja.** Höyryt voivat ärsyttää hengitystiehy-eitä.
- ▶ **Viallisesta akusta voi vuotaa nestettä, joka kostuttaa viereisiä esineitä. Tarkista kastuneet osat.** Puhdista tai vaihda ne tarvittaessa.

Latauslaitteiden turvallisuusohjeet



Pidä sähkötyökalu poissa sateesta ja kosteudesta. Veden tunkeutuminen latauslaitteen sisään kasvattaa sähköiskun riskiä.

- ▶ **Älä lataa vieraita akkuja.** Latauslaite soveltuu ainoastaan Bosch-litiumioni akkujen lataukseen, joiden jännite on teknisissä tiedoissa mainittu. Muussa tapauksessa syntyy tulipalo- ja räjähdysvaara.
- ▶ **Pidä latauslaite puhtaana.** Likaantuminen lisää sähköiskun vaaraa.
- ▶ **Tarkista latauslaite, johto ja pistoke, ennen jokaista käyttöä. Älä käytä latauslaitetta, jos huomaat siinä olevan vaurioita. Älä avaa latauslaitetta itse ja anna ainoastaan ammattitaitoisten henkilöiden korjata sitä, alkuperäisiä varaosia käyttäen.** Vahingoittuneet latauslaitteet, johdot tai pistokkeet kasvattavat sähköiskun vaaraa.
- ▶ **Älä käytä latauslaitetta helposti palavalla alustalla (esim. paperi, kangas jne.) tai palavassa ympäristössä.** Latauslaitteen kuumeneminen latauksen aikana synnyttää tulipalovaaran.

Toimintaselostus



Lue kaikki turvallisuus- ja muut ohjeet. Turvallisuusohjeiden noudattamisen laiminlyönti saattaa johtaa sähköiskuun, tulipalloon ja/tai vakavaan loukkaantumiseen.

Määräyksenmukainen käyttö

Laite on tarkoitettu ruuvien kiristämiseen ja avaamiseen. Käytä sähkötyökalua ainoastaan, jos täysin pystyt arvioimaan ja hallitsemaan rajoituksetta kaikkia toimintoja tai olet saanut vastaavia ohjeita.

Kuvassa olevat osat

Kuvassa olevien osien numerointi viittaa grafiikkasivussa olevaan sähkötyökalun kuvaan.

- 1 Ruuvauskärki*
- 2 Työkalunpidin
- 3 Vääntömomenttiasetuksen säätörengas
- 4 Kiertosuunnan näyttö oikealle
- 5 Akun latausvalvontanäyttö
- 6 Kiertosuunnan näyttö vasemmalle
- 7 "Power Light"-lamppu
- 8 Käynnistyskytkin
- 9 Suunnanvaihtokytkin
- 10 Latauslaite

***Kuvassa tai selostuksessa esiintyvä lisätarvike ei kuulu vakio-toimitukseen. Löydät täydellisen tarvikeluettelon tarvikeohjelmastamme.**

Suomi | 211

Tekniset tiedot

Akkuruuvinväännin		PSR 7,2 LI
Tuotenumero		3 603 J57 7..
Nimellisjännite	V=	7,2
Tyhjäkäyntikierrosluku	min ⁻¹	0–230
Suurin vääntömomentti kovassa/pehmeässä ruuvinväännössä ISO 5393 mukaan	Nm	10/6
maks. ruuvin Ø	mm	6
Paino vastaa EPTA-Procedure 01/2003	kg	0,5
Akku		Li-ioni
Kapasiteetti	Ah	1,3
Akkukennojen lukumäärä		2
Latauslaite		
Tuotenumero		2 607 225 553 (EU) 2 607 225 555 (UK)
Latausaika	h	5,0

Ota huomioon sähkötyökalusi mallikilvessä oleva tuotenumero. Yksittäisten koneiden kaupanimitys saattaa vaihdella.

Melu-/värinätiedot

Mittausarvot määritetty EN 60745 mukaan.

Laitteen A-arvioitu äänen painetaso on tyypillisesti alle 70 dB(A). Epävarmuus K = 3 dB.

Melu saattaa työn aikana ylittää 80 dB(A).

Käytä kuulinsuojaimia!

Värähtelyn yhteisarvot (kolmen suunnan vektorisumma) mitattuna EN 60745 mukaan:

Ruuvit: Värähtelyemissioarvo $a_h < 2,5 \text{ m/s}^2$, epävarmuus $K = 1,5 \text{ m/s}^2$.

Näissä ohjeissa mainittu värähtelytaso on mitattu EN 60745 standardoidun mittausmenetelmän mukaisesti ja sitä voidaan käyttää sähkötyökalujen vertailussa. Se soveltuu myös värähtelyrasituksen väliaikaiseen arviointiin. Ilmoitettu värähtelytaso vastaa sähkötyökalun pääasiallisia käyttötapoja. Jos sähkötyökalua kuitenkin käytetään muissa töissä, poikkeavilla vaihtotyökaluilla tai riittämättömästi huollettuna, saattaa värähtelytaso poiketa. Tämä saattaa kasvattaa koko työaikajakson värähtelyrasitusta huomattavasti.

Värähtelyrasituksen tarkkaa arviointia varten määrätyn työaikajakson aikana tulisi ottaa huomioon myös se aika, jolloin laite on sammutettuna tai käy, mutta sitä ei tosiasias-
assa käytetä. Tämä voi selvästi pienentää koko työaikajakson värähtelyrasitusta.

Määrittele lisävarotoimenpiteet käyttäjän suojaksi värähtelyn vaikutukselta, kuten esimerkiksi: Sähkötyökalujen ja vaihtotyökalujen huolto, käsien pitäminen lämpiminä, työnkulun organisointi.

Standardinmukaisuusvakuutus 

Vakuutamme yksin vastaavamme siitä, että kohdassa "Tekniset tiedot" selostettu tuote vastaa seuraavia standardeja tai standardoituja asiakirjoja: EN 60745 (akkulaitteet) ja EN 60335 (akkulaturit) direktiivien 2006/95/EY, 2004/108/EY, 98/37/EY (28.12.2009 asti), 2006/42/EY (29.12.2009 alkaen) määräysten mukaan.

Tekninen tiedosto kohdasta:
Robert Bosch GmbH, PT/ESC,
D-70745 Leinfelden-Echterdingen

CE 08

Dr. Egbert Schneider Senior Vice President Engineering	Dr. Eckerhard Strötgen Head of Product Certification
--	--

Dr. Egbert Schneider *Dr. Eckerhard Strötgen*

Robert Bosch GmbH, Power Tools Division
D-70745 Leinfelden-Echterdingen
16.09.2008

Asennus**Akun lataus (katso kuva A)**

- **Älä käytä mitään muuta latauslaitetta.** Toimitukseen kuuluva latauslaite on sovitettu laitteen sisäänrakennetulle Li-ioni-akulle.

**214 | Suomi**

- ▶ **Ota huomioon verkkojännite!** Virtalähteen jännitteen tulee vastata laitteen tyyppikilvessä olevia tietoja. 230 V merkityjä laitteita voidaan käyttää myös 220 V verkoissa.

Huomio: Akku toimitetaan osittain ladattuna. Jotta akun täysi teho voitaisiin taata, tulee akku ennen ensimmäistä käyttöönottoa ladata täyteen latauslaitteessa.

Litiumioni-akkua voidaan ladata milloin vain, lyhentämättä akun elinikää. Latauksen keskeytys ei vaurioita akkua.

Li-ioni-akku on suojattu syväpurkausta vastaan "Electronic Cell Protection (ECP)" avulla. Akun tyhjetessä suoja-kytkentä pysäyttää sähkötyökalun: Vaihtotyökalu ei enää liiku.

⚠ HUOM Älä enää paina käynnistyskytkintä sähkötyökalun automaattisen poiskytkennän jälkeen. Akku saattaa vahingoittua.

Lataustapahtuma alkaa heti, kun latauslaitteen verkkopistotulppa liitetään pistorasiaan ja akkuruuvinväännin samalla asetetaan latauslaitteeseen **10**.

Akun latausvalvontanäyttö **5** osoittaa latauksen jatkumisen. Latauksen aikana näytön valo **vilkkuu** vihreänä. Akku on täysin ladattu, kun näytön valo on **pysyvästi** vihreä.

Latauksen aikana sähkötyökalun kahva lämpenee. Tämä on normaalia.

Irrota latauslaitteen pistotulppa pistorasiasta, ellei sitä käytetä pitkään aikaan.

Sähkötyökalua ei voi käyttää latauksen aikana; siinä ei ole vikaa, kun se ei toimi latauksen aikana.

Ota huomioon hävitysohjeet.

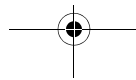
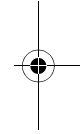
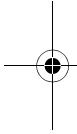

Työkalunvaihto (katso kuva B)

- ▶ **Aseta aina suunnanvaihtokytkin keskiasentoon ennen kaikkia laitteeseen kohdistuvia töitä (esim. huolto, työkalun vaihto jne.) sekä laitetta kuljettaessa ja säilytettäessä.** Muutoin käynnistyskytkimen tahaton painallus muodostaa loukkaantumisvaaran.
- ▶ **Älä käytä kaksipuolisia, yli 25 mm pitkiä ruuvitaltoja.**

Aseta ruuvauskärki **1** suoraan työkalunpitimeen **2**.

Käyttö

Käyttöönotto

Kiertosuunnan asetus (katso kuva C)

Suunnanvaihtokytkimellä **9** voit muuttaa sähkötyökalun kiertosuunnan. Käynnistyskytkimen **8** ollessa painettuna tämä ei kuitenkaan ole mahdollista.

Kierto oikealle: Ruuvien sisäänkiristämistä varten painat suunnanvaihtokytkintä **9** vasemmalle vasteseen asti.

 Kiertosuunnan näyttö oikealle **4** palaa käynnistyskytkintä **8** painettaessa ja moottorin käydessä.

Kierto vasemmalle: Ruuvien ja muttereiden avaamista ja uloskiertoa varten painat suunnanvaihtokytkintä **9** oikealle vasteseen asti.

 Kiertosuunnan näyttö vasemmalle **6** palaa käynnistyskytkintä **8** painettaessa ja moottorin käydessä.



Vääntömomentin asetus

Vääntömomenttiasetuksen säätörenkaalla **3** voit asettaa tarvittavan vääntömomentin 10 portaassa. Heti, kun asetettu vääntömomentti on saavutettu, vaihtotyökalu pysäytetään.

Vaihe 1:

Pieni vääntömomentti ruuvinvääntöön pieniläpimittaisille ruuveille tai pehmeään materiaaliin.

Vaihe 10:

Suurempi vääntömomentti, ruuvinvääntöön suuriläpimittaisille ruuveille tai kovaan materiaaliin.

Käynnistys ja pysäytys

Paina sähkötyökalun **käynnistystä varten** käynnistyskytkintä **8** ja pidä se painettuna.

Lamppu **7** palaa, kun käynnistyskytkintä **8** painetaan vähän tai kokonaan pohjaan ja mahdollistaa ruuvauskohdan valaisun epäsuotuisissa valo-olosuhteissa.

Sähkötyökalun **pysäytys** päästämällä käynnistys- kytkin **8** vapaaksi.

Kierrosluvun asetus

Voit säätää käynnissä olevan sähkötyökalun kierroslukua portaattomasti, riippuen siitä miten syvälle painat käynnistyskytkintä **8**.

Käynnistyskytkimen **8** kevyt painallus aikaansaa alhaisen kierrosluvun. Paineen kasvaessa, nousee kierrosluku.

Täysautomaattinen karalukitus (Auto-Lock)

Poraistukka ja samalla työkalunpidin ovat lukkiutuneena, kun käynnistyskytkintä **8** ei paineta.

Tämä mahdollistaa ruuvien sisäänruuvauksen myös tyhjällä akulla sekä tuotteen käytön ruuvitaltana.

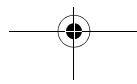
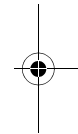
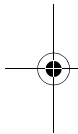

Lämpötilariippuva ylikuormitusuoja

Asiallisessa käytössä ei sähkötyökalua voida ylikuormittaa. Liian suurella kuormalla tai, jos akun sallittu lämpötila 70 °C ylitetään kytkee sähkötyökalun elektroniikka irti, kunnes työkalu taas on saavuttanut optimaalisen käyttölämpötilan.

Syväpurkaussuoja

Li-ioni-akku on suojattu syväpurkausta vastaan "Electronic Cell Protection (ECP)" avulla. Akun tyhjetessä suoja-kytkentä pysäyttää sähkötyökalun: Vaihtotyökalu ei enää liiku.

Työskentelyohjeita

- **Laske työkalu ruuvin päälle, ennen kuin kytket virran.** Varo, ettei käynnissä oleva työkalu luiskahda pois paikaltaan.

Hoito ja huolto

Huolto ja puhdistus

- **Aseta aina suunnanvaihtokytkin keskiasentoon ennen kaikkia laitteeseen kohdistuvia töitä (esim. huolto, työkalun vaihto jne.) sekä laitetta kuljetettaessa ja säilytettäessä.** Muutoin käynnistyskytkimen tahaton painallus muodostaa loukkaantumisvaaran.
- **Pidä aina sähkötyökalua ja sähkötyökalun tuuletusaukkoja puhtaana, jotta voit työskennellä hyvin ja turvallisesti.**



218 | Suomi



Jos akku ei enää toimi, käänny Bosch-sopimushuollon puoleen.

Jos sähkötyökalussa, huolellisesta valmistuksesta ja koestusmenettelystä huolimatta esiintyy vikaa, tulee korjaus antaa Bosch sopimushuollon tehtäväksi.

Ilmoita kaikissa kyselyissä ja varaosatilauksissa 10-numeroinen tuotenumero, joka löytyy laitteen mallikilvestä.

Asiakaspalvelu ja asiakasneuvonta

Asiakaspalvelu vastaa tuotteesi korjausta ja huoltoa sekä varaosia koskeviin kysymyksiin. Räjähdyspiirustuksia ja tietoja varaosista löydät myös osoitteesta:

www.bosch-pt.com

Bosch-asiakasneuvontatiimi auttaa mielellään sinua tuotteiden ja lisätarvikkeiden ostoa, käyttöä ja säätöä koskeissa kysymyksissä.

Suomi

Robert Bosch Oy
Bosch-keskushuolto
Pakkalantie 21 A
01510 Vantaa
Puh.: +358 (09) 435 991
Faksi: +358 (09) 870 2318
www.bosch.fi

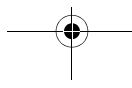
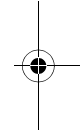
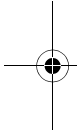

Kuljetus

Akku on testattu UN-käsikirjan ST/SG/AC.10/11/korj.3 osa III, alaotsikko 38.3 mukaan. Siinä on aktiivinen suoja sisäistä ylipainetta ja oikosulkua vasten sekä rakenteita, jotka estävät väkivaltaisen murron ja vaarallisen takavirran.

Akun sisältämä litiumekvivalenttimäärä alittaa kyseisiä raja-arvoja. Tästä johtuen akku ei yksikkönä eikä laitteeseen asennettuna kuulu kansallisiin tai kansainvälisiin vaarallisten aineiden säännösten piiriin. Vaarallisten aineiden säännökset voivat kuitenkin tulla kysymykseen kuljetettaessa useita akkuja. Tässä tapauksessa saattaa olla välttämätöntä noudattaa määrättyjä edellytyksiä (esim. pakkauksen suhteen). Tarkemmat tiedot löydät englanninkielisestä ohjelehdessä allaolevasta internetsoitteesta: <http://purchasing.bosch.com/en/start/Allgemeines/Download/index.htm>.

Hävitys

Sähkötyökalu, lisätarvikkeet ja pakkaukset tulee toimittaa ympäristöystävälliseen uusiokäyttöön.

Vain EU-maita varten:



Älä heitä sähkötyökaluja talousjätteisiin! Eurooppalaisen vanhoja sähkö- ja elektroniikkalaitteita koskevan direktiivin 2002/96/EY ja sen kansallisten lakien muunnosten mukaan, tulee käyttökelvottomat sähkötyökalut kerätä erikseen ja toimittaa ympäristöystävälliseen uusiokäyttöön.

220 | Suomi**Akut/paristot:****Li-ioni:**

Katso ohjeita kappaleessa "Kuljetus", sivu 219.

Älä heitä akkua/paristoja talousjätteisiin, tuleen tai veteen. Akut/paristot tulee kerätä, kierrättää tai hävittää ympäristöystävällisellä tavalla.

Vain EU-maita varten:

Vialliset tai loppuunkäytetyt akut tulee kierrättää direktiivin 91/157/ETY mukaisesti.

Poistaaksesi akun sähkötyökalusta, painat käynnistyskytkintä **8** kunnes akku on purkautunut täysin. Kierrä auki kotelon ruuvit ja poista kuppikotelo. Irrota akun liitokset ja ota akku ulos.

Oikeus teknisiin muutoksiin pidätetään.

Υποδείξεις ασφαλείας

Γενικές προειδοποιητικές υποδείξεις για ηλεκτρικά εργαλεία

⚠ ΠΡΟΕΙΔΟΠΟΙΗΣΗ Διαβάστε όλες τις προειδοποιητικές υποδείξεις.

Αμέλειες κατά την τήρηση των προειδοποιητικών υποδείξεων μπορεί να προκαλέσουν ηλεκτροπληξία, κίνδυνο πυρκαγιάς ή/και σοβαρούς τραυματισμούς.

Φυλάξτε όλες τις προειδοποιητικές υποδείξεις και οδηγίες για κάθε μελλοντική χρήση.

Ο ορισμός «Ηλεκτρικό εργαλείο» που χρησιμοποιείται στις προειδοποιητικές υποδείξεις αναφέρεται σε ηλεκτρικά εργαλεία που τροφοδοτούνται από το ηλεκτρικό δίκτυο (με ηλεκτρικό καλώδιο) καθώς και σε ηλεκτρικά εργαλεία που τροφοδοτούνται από μπαταρία (χωρίς ηλεκτρικό καλώδιο).

1) Ασφάλεια στο χώρο εργασίας

a) Διατηρείτε τον τομέα που εργάζεσθε καθαρό και καλά φωτισμένο. Αταξία ή μη φωτισμένες περιοχές εργασίας μπορεί να οδηγήσουν σε ατυχήματα.

b) Μην εργάζεσθε με το ηλεκτρικό εργαλείο σε περιβάλλον όπου υπάρχει κίνδυνος έκρηξης, στο οποίο υπάρχουν εύφλεκτα υγρά, αέρια ή σκόνες. Τα ηλεκτρικά εργαλεία δημιουργούν σπινθηρισμό ο οποίος μπορεί να αναφλέξει τη σκόνη ή τις αναθυμιάσεις.

c) Όταν χρησιμοποιείτε το ηλεκτρικό εργαλείο κρατάτε μακριά απ' αυτό τα παιδιά κι άλλα τυχόν παρευρισκόμενα άτομα. Σε περίπτωση απόσπασης της προσοχής σας μπορεί να χάσετε τον έλεγχο του μηχανήματος.

222 | Ελληνικά

2) Ηλεκτρική ασφάλεια

- a) Το φως του ηλεκτρικού εργαλείου πρέπει να ταιριάζει στην πρίζα. Δεν επιτρέπεται με κανέναν τρόπο η μετατροπή του φως. Μη χρησιμοποιείτε προσαρμοστικά φως σε συνδυασμό με γειωμένα ηλεκτρικά εργαλεία. Μη μεταποιημένα φως και κατάλληλες πρίζες μειώνουν τον κίνδυνο ηλεκτροπληξίας.**
- b) Αποφεύγετε την επαφή του σώματός σας με γειωμένες επιφάνειες όπως σωλήνες, θερμαντικά σώματα (καλοριφέρ), κουζίνες ή ψυγεία. Όταν το σώμα σας είναι γειωμένο αυξάνεται ο κίνδυνος ηλεκτροπληξίας.**
- c) Μην εκθέτετε τα μηχανήματα στη βροχή ή την υγρασία. Η διείσδυση νερού σ' ένα ηλεκτρικό εργαλείο αυξάνει τον κίνδυνο ηλεκτροπληξίας.**
- d) Μη χρησιμοποιείτε το ηλεκτρικό καλώδιο για να μεταφέρετε ή να αναρτήσετε το ηλεκτρικό εργαλείο, ή για να βγάλετε το φως από την πρίζα. Κρατάτε το ηλεκτρικό καλώδιο μακριά από υπερβολικές θερμοκρασίες, κοφτερές ακμές και/ή από κινητά εξαρτήματα. Τυχόν χαλασμένα ή περιπλεγμένα ηλεκτρικά καλώδια αυξάνουν τον κίνδυνο ηλεκτροπληξίας.**
- e) Όταν εργάζεστε μ' ένα ηλεκτρικό εργαλείο στο ύπαιθρο να χρησιμοποιείτε καλώδια επιμήκυνσης (μπαλαντέζες) που είναι κατάλληλα και για χρήση στο ύπαιθρο. Η χρήση καλωδίων επιμήκυνσης κατάλληλων για υπαίθριους χώρους ελαττώνει τον κίνδυνο ηλεκτροπληξίας.**

f) Όταν η χρήση του ηλεκτρικού εργαλείου σε υγρό περιβάλλον είναι αναπόφευκτη, τότε χρησιμοποιήστε έναν προστατευτικό διακόπτη διαρροής (διακόπτη FI). Η χρήση ενός προστατευτικού διακόπτη διαρροής ελαττώνει τον κίνδυνο ηλεκτροπληξίας.

3) Ασφάλεια προσώπων

a) Να είστε πάντοτε προσεκτικός/προσεκτική, να δίνετε προσοχή στην εργασία που κάνετε και να χειρίζεστε το μηχάνημα με περίσκεψη. Μη χρησιμοποιήσετε ένα ηλεκτρικό εργαλείο όταν είστε κουρασμένος/κουρασμένη ή όταν βρίσκεστε υπό την επιρροή ναρκωτικών, οινοπνεύματος ή φαρμάκων. Μια στιγμιαία απροσεξία κατά το χειρισμό του ηλεκτρικού εργαλείου μπορεί να οδηγήσει σε σοβαρούς τραυματισμούς.

b) Φοράτε έναν κατάλληλο για σας προστατευτικό εξοπλισμό και πάντοτε προστατευτικά γυαλιά. Όταν φοράτε έναν κατάλληλο προστατευτικό εξοπλισμό όπως μάσκα προστασίας από σκόνη, αντιολισθητικά υποδήματα ασφαλείας, προστατευτικό κράνος ή ωτασπίδες, ανάλογα με εκάστοτε εργαλείο και τη χρήση του, ελαττώνεται ο κίνδυνος τραυματισμών.

c) Αποφεύγετε την αθέλητη εκκίνηση. Βεβαιωθείτε ότι το ηλεκτρικό εργαλείο έχει αποζευχτεί πριν το συνδέσετε με το ηλεκτρικό δίκτυο ή με την μπαταρία καθώς και πριν το παραλάβετε ή το μεταφέρετε. Όταν μεταφέρετε το ηλεκτρικό εργαλείο έχοντας το δάχτυλό σας στο διακόπτη ή όταν συνδέσετε το μηχάνημα με την πηγή ρεύματος όταν αυτό είναι ακόμη συζευγμένο, τότε δημιουργείται κίνδυνος τραυματισμών.

**224 | Ελληνικά****d) Αφαιρείτε από τα ηλεκτρικά εργαλεία τυχόν συναρμολογημένα εργαλεία ρύθμισης ή κλειδιά πριν θέσετε το ηλεκτρικό εργαλείο σε λειτουργία.**

Ένα εργαλείο ή κλειδί συναρμολογημένο σ' ένα περιστρεφόμενο τμήμα ενός μηχανήματος μπορεί να οδηγήσει σε τραυματισμούς.

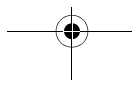
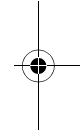
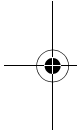
e) Μην υπερεκτιμάτε τον εαυτό σας. Φροντίζετε για την ασφαλή στάση του σώματός σας και διατηρείτε πάντοτε την ισορροπία σας. Έτσι μπορείτε να ελέγξετε καλύτερα το μηχάνημα σε περιπτώσεις απροσδόκητων περιστάσεων.**f) Φοράτε κατάλληλα ενδύματα. Μη φοράτε φαρδιά ρούχα ή κοσμήματα. Κρατάτε τα μαλλιά σας, τα ρούχα σας και τα γάντια σας μακριά από κινούμενα εξαρτήματα.** Χαλαρή ενδυμασία, κοσμήματα ή μακριά μαλλιά μπορεί να εμπλακούν στα κινούμενα εξαρτήματα.**g) Όταν υπάρχει η δυνατότητα συναρμολόγησης διατάξεων αναρρόφησης ή συλλογής σκόνης, βεβαιωθείτε ότι αυτές είναι συνδεδεμένες με το μηχάνημα καθώς και ότι χρησιμοποιούνται σωστά.** Η χρήση μιας αναρρόφησης σκόνης μπορεί να ελαττώσει τον κίνδυνο που προκαλείται από τη σκόνη.**4) Επιμελής χειρισμός και χρήση ηλεκτρικών εργαλείων****a) Μην υπερφορτώνετε το μηχάνημα. Χρησιμοποιείτε για την εκάστοτε εργασία το ηλεκτρικό εργαλείο που προορίζεται γι' αυτήν.** Με το κατάλληλο ηλεκτρικό εργαλείο εργάζεστε καλύτερα και ασφαλέστερα στην αναφερόμενη περιοχή ισχύος.



b) Μη χρησιμοποιήσετε ποτέ ένα μηχάνημα που έχει χαλασμένο διακόπτη. Ένα ηλεκτρικό εργαλείο που δεν μπορείτε πλέον να το θέσετε σε λειτουργία και/ή εκτός λειτουργίας είναι επικίνδυνο και πρέπει να επισκευαστεί.

c) Βγάζετε το φις από την πρίζα και/ή αφαιρέστε την μπαταρία πριν διεξάγετε στο μηχάνημα μια οποιαδήποτε εργασία ρύθμισης, πριν αλλάξετε ένα εξάρτημα ή όταν πρόκειται να διαφυλάξετε/να αποθηκεύσετε το μηχάνημα. Αυτά τα προληπτικά μέτρα ασφαλείας μειώνουν τον κίνδυνο από τυχόν αθέλητη εκκίνηση του ηλεκτρικού εργαλείου.

d) Διαφυλάγετε τα ηλεκτρικά εργαλεία που δε χρησιμοποιείτε μακριά από παιδιά. Μην επιτρέψετε τη χρήση του μηχανήματος σε άτομα που δεν είναι εξοικειωμένα μ' αυτό ή δεν έχουν διαβάσει τις παρούσες οδηγίες. Τα ηλεκτρικά εργαλεία είναι επικίνδυνα όταν χρησιμοποιούνται από άπειρα πρόσωπα.

e) Να περιποιείστε προσεκτικά το ηλεκτρικό εργαλείο. Ελέγχετε, αν τα κινούμενα εξαρτήματα λειτουργούν άψογα, χωρίς να μπλοκάρουν, ή μήπως έχουν σπάσει ή φθαρεί τυχόν εξαρτήματα τα οποία επηρεάζουν τον τρόπο λειτουργίας του ηλεκτρικού εργαλείου. Δώστε αυτά τα χαλασμένα εξαρτήματα για επισκευή πριν τα ξαναχρησιμοποιήσετε. Η κακή συντήρηση των ηλεκτρικών εργαλείων αποτελεί αιτία πολλών ατυχημάτων.

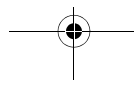
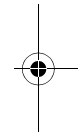
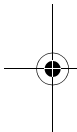



f) Διατηρείτε τα εργαλεία κοπής κοφτερά και καθαρά. Προσεκτικά συντηρημένα κοπτικά εργαλεία σφηνώνουν δυσκολότερα και οδηγούνται ευκολότερα.

g) Χρησιμοποιείτε ηλεκτρικά εργαλεία, εξαρτήματα, παρελκόμενα εργαλεία κτλ. σύμφωνα με τις παρούσες οδηγίες. Λαμβάνετε επίσης υπόψη σας τις εκάστοτε συνθήκες και την υπό εκτέλεση εργασία. Η χρησιμοποίηση των ηλεκτρικών εργαλείων για εργασίες που δεν προβλέπονται γι' αυτά μπορεί να δημιουργήσει επικίνδυνες καταστάσεις.

5) Προσεκτικός χειρισμός και χρήση εργαλείων μπαταρίας

a) Φορτίζετε τις μπαταρίες μόνο με φορτιστές που προτείνονται από τον κατασκευαστή. Ένας φορτιστής που είναι κατάλληλος μόνο για ένα συγκεκριμένο τύπο μπαταριών δημιουργεί κίνδυνο πυρκαγιάς όταν χρησιμοποιηθεί για άλλες μπαταρίες.

b) Χρησιμοποιείτε στα ηλεκτρικά εργαλεία μόνο μπαταρίες που προορίζονται γι' αυτά. Η χρήση άλλων μπαταριών μπορεί να οδηγήσει σε τραυματισμούς και να δημιουργήσει κίνδυνο πυρκαγιάς.

c) Κρατάτε τις μπαταρίες που δε χρησιμοποιείτε μακριά από συνδετήρες χαρτιών, νομίσματα, κλειδιά, καρφιά, βίδες κι άλλα μικρά μεταλλικά αντικείμενα που μπορούν να βραχυκυκλώσουν τις επαφές της μπαταρίας. Ένα βραχυκύκλωμα των επαφών της μπαταρίας μπορεί να προκαλέσει τραυματισμούς ή φωτιά.

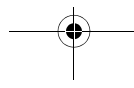
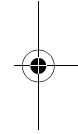
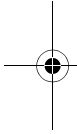

d) Μια τυχόν εσφαλμένη χρησιμοποίηση μπορεί να οδηγήσει σε διαρροή υγρών από την μπαταρία. Αποφεύγετε κάθε επαφή μ' αυτά. Σε περίπτωση τυχαίας επαφής ξεπλύνετε καλά με νερό. Σε περίπτωση που τα υγρά θα έρθουν σε επαφή με τα μάτια, πρέπει να ζητήσετε επίσης και ιατρική βοήθεια. Διαρρέοντα υγρά μπαταρίας μπορεί να οδηγήσουν σε ερεθισμούς του δέρματος ή σε εγκαύματα.

6) Service

a) Δώστε το ηλεκτρικό σας εργαλείο σας για επισκευή από άριστα εκπαιδευμένο προσωπικό και με γνήσια ανταλλακτικά. Έτσι εξασφαλίζετε τη διατήρηση της ασφάλειας του μηχανήματος.

Υποδείξεις ασφαλείας για κατασβίδια

- ▶ **Να πιάνετε το μηχάνημα από τις μονωμένες επιφάνειες συγκράτησης όταν πρόκειται να διεξάγετε εργασίες κατά τις οποίες υπάρχει κίνδυνος η βίδα να συναντήσει τυχόν μη ορατές ηλεκτροφόρες γραμμές.** Η επαφή της βίδας με μια υπό τάση ευρισκόμενη ηλεκτρική γραμμή μπορεί να θέσει μεταλλικά τμήματα του μηχανήματος επίσης υπό τάση και να οδηγήσει έτσι σε ηλεκτροπληξία.
- ▶ **Κρατάτε καλά το ηλεκτρικό εργαλείο.** Όταν βιδώνετε ή λύνετε βίδες μπορεί να εμφανιστούν πρόσκαιρα αντιδραστικές ροπές (κλοσήματα).
- ▶ **Ασφαλιζετε το υπό κατεργασία τεμάχιο.** Ένα υπό κατεργασία τεμάχιο συγκρατείται ασφαλέστερα με μια διάταξη σύσφιγξης ή με μια μέγγενη παρά με το χέρι σας.

228 | Ελληνικά

- ▶ **Πριν διεξάγετε οποιαδήποτε εργασία στο ίδιο το ηλεκτρικό εργαλείο (π. χ. συντήρηση, αλλαγή εργαλείου κτλ.) καθώς και όταν πρόκειται να το μεταφέρετε θέστε το διακόπτη αλλαγής φοράς περιστροφής στη μεσαία θέση.** Σε περίπτωση αθέλητης ενεργοποίησης του διακόπτη ON/OFF υπάρχει κίνδυνος τραυματισμού.
- ▶ **Αποφεύγετε την αθέλητη εκκίνηση. Πριν τοποθετήσετε μια μπαταρία βεβαιωθείτε ότι ο διακόπτης ON/OFF είναι απενεργοποιημένος (βρίσκεται στη θέση OFF).** Όταν μεταφέρετε το ηλεκτρικό εργαλείο έχοντας το δάχτυλό σας στο διακόπτη ON/OFF, ή όταν τοποθετήσετε την μπαταρία στο ηλεκτρικό εργαλείο όταν αυτό είναι ακόμη συζευγμένο, δημιουργείται κίνδυνος τραυματισμών.
- ▶ **Μην ανοίγετε την μπαταρία.** Υπάρχει κίνδυνος βραχυκυκλώματος.
 -  **Να προστατεύετε το ηλεκτρικό εργαλείο από υψηλές θερμοκρασίες, π.χ. επίσης και από διαρκή ηλιακή ακτινοβολία, καθώς και από φωτιά.** Υπάρχει κίνδυνος έκρηξης.
- ▶ **Σε περίπτωση βλάβης ή/και αντικανονικής χρήσης της μπαταρίας μπορεί να εξέλθουν αναθυμιάσεις από την μπαταρία. Αφήστε να μπει φρέσκος αέρας και επισκεφτείτε ένα γιατρό αν αισθανθείτε ενοχλήσεις.** Οι αναθυμιάσεις μπορεί να ερεθίσουν τις αναπνευστικές οδούς.
- ▶ **Όταν η μπαταρία είναι χαλασμένη μπορεί να εκρεύσουν υγρά και να υγράνουν τα γειτονικά αντικείμενα. Να ελέγχετε τα σχετικά εξαρτήματα.** Να καθαρίζετε τα εξαρτήματα αυτά και, αν χρειαστεί, να τα αντικαθιστάτε.

Υποδείξεις ασφαλείας για φορτιστές



Μην εκθέτετε τη συσκευή στη βροχή και την υγρασία. Η διείσδυση νερού σ' ένα φορτιστή αυξάνει τον κίνδυνο ηλεκτροπληξίας.

- ▶ **Μη φορτίζετε ξένες μπαταρίες.** Ο φορτιστής προορίζεται μόνο για τη φόρτιση μπαταριών ιόντων λιθίου της Bosch με τις τάσεις που αναφέρονται στα Τεχνικά Χαρακτηριστικά. Διαφορετικά υπάρχει κίνδυνος έκρηξης και πυρκαγιάς.
- ▶ **Διατηρείτε το φορτιστή καθαρό.** Η ρύπανση της συσκευής δημιουργεί κίνδυνο ηλεκτροπληξίας.
- ▶ **Ελέγχετε πριν από κάθε χρήση το φορτιστή, το ηλεκτρικό καλώδιο και το φις.** Μη χρησιμοποιήσετε το φορτιστή σε περίπτωση που θα εξακριβώσετε κάποιες βλάβες ή ζημιές. Μη ανοίξετε οι ίδιοι το φορτιστή αλλά δώστε τον οπωσδήποτε σε ειδικά εκπαιδευμένο τεχνικό προσωπικό για να το επισκευάσει με γνήσια εξαρτήματα. Χαλασμένοι φορτιστές, καλώδια και φις αυξάνουν τον κίνδυνο ηλεκτροπληξίας.
- ▶ **Μην αφήσετε το φορτιστή να λειτουργήσει επάνω σε μια εύφλεκτη επιφάνεια (π.χ. χαρτί, υφάσματα κτλ.) ή μέσα σε εύφλεκτο περιβάλλον.** Δημιουργείται κίνδυνος πυρκαγιάς εξαιτίας της θέρμανσης του φορτιστή.

Περιγραφή λειτουργίας



Διαβάστε όλες τις προειδοποιητικές υποδείξεις. Αμέλειες κατά την τήρηση των προειδοποιητικών υποδείξεων μπορεί να προκαλέσουν ηλεκτροπληξία, κίνδυνο πυρκαγιάς ή/και σοβαρούς τραυματισμούς.



Χρήση σύμφωνα με τον προορισμό

Το μηχάνημα προορίζεται για το βίδωμα και το λύσιμο βιδών.

Να χρησιμοποιείτε το ηλεκτρικό εργαλείο μόνο όταν είστε σε θέση να αξιολογήσετε όλες τις λειτουργίες του και μπορείτε να τις εκτελέσετε χωρίς κανέναν περιορισμό ή όταν έχετε λάβει ανάλογες οδηγίες.

Απεικονιζόμενα στοιχεία

Η απαρίθμηση των απεικονιζόμενων στοιχείων αναφέρεται στην απεικόνιση του ηλεκτρικού εργαλείου στη σελίδα γραφικών.

- 1 Μύτη βιδώματος (bit) *
- 2 Υποδοχή εργαλείου
- 3 Δακτύλιος ρύθμισης προεπιλογής ροπής στρέψης
- 4 Ένδειξη φοράς περιστροφής Δεξιόστροφη κίνηση
- 5 Ένδειξη κατάστασης φόρτισης
- 6 Ένδειξη φοράς περιστροφής Αριστερόστροφη κίνηση
- 7 Λάμπα «Power Light»
- 8 Διακόπτης ON/OFF
- 9 Διακόπτης αλλαγής φοράς περιστροφής
- 10 Φορτιστής

*** Εξαρτήματα που απεικονίζονται ή περιγράφονται δεν περιέχονται στη στάνταρ συσκευασία. Για τον πλήρη κατάλογο εξαρτημάτων κοιτά το πρόγραμμα εξαρτημάτων.**

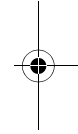
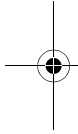

Τεχνικά χαρακτηριστικά

Δραπανοκατσάβιδο μπαταρίας		PSR 7,2 LI
Αριθμός ευρετηρίου		3 603 J57 7..
Ονομαστική τάση	V=	7,2
Αριθμός στροφών χωρίς φορτίο	min ⁻¹	0–230
μέγιστη ροπή στρέψης σκληρή/μαλακή περίπτωση βιδώματος σύμφωνα με ISO 5393	Nm	10/6
μέγιστη διάμετρος βίδας	mm	6
Βάρος σύμφωνα με EPTA-Procedure 01/2003	kg	0,5
Μπαταρία		Ιόντα λιθίου
Χωρητικότητα	Ah	1,3
Αριθμός των στοιχείων μπαταρίας		2
Φορτιστής		
Αριθμός ευρετηρίου		2 607 225 553 (EU) 2 607 225 555 (UK)
Χρόνος φόρτισης	h	5,0
<p>Παρακαλούμε να προσέξετε τον αριθμό ευρετηρίου στην πινακίδα κατασκευαστή του ηλεκτρικού εργαλείου σας. Οι εμπορικοί χαρακτηρισμοί ορισμένων ηλεκτρικών εργαλείων μπορεί να διαφέρουν.</p>		



Πληροφορίες για θόρυβο και δονήσεις

Οι τιμές μέτρησης εξακριβώθηκαν σύμφωνα με την προδιαγραφή EN 60745.

Σύμφωνα με την καμπύλη η χαρακτηριστική στάθμη ακουστικής πίεσης του μηχανήματος είναι μικρότερη από 70 dB(A). Ανασφάλεια K = 3 dB.

Η στάθμη θορύβου κατά την εργασία μπορεί να ξεπεράσει τα 80 dB(A).

Φοράτε ωτασπίδες!

Οι ολικές τιμές κραδασμών (άθροισμα ανυσμάτων τριών διευθύνσεων) εξακριβώθηκαν σύμφωνα με το πρότυπο EN 60745:

Βίδωμα: Τιμή εκπομπής κραδασμών $a_h < 2,5 \text{ m/s}^2$, ανασφάλεια K = 1,5 m/s^2 .

Η στάθμη κραδασμών που αναφέρεται σ' αυτές τις οδηγίες έχει μετρηθεί σύμφωνα με μια διαδικασία μέτρησης τυποποιημένη στο πλαίσιο του προτύπου EN 60745 και μπορεί να χρησιμοποιηθεί στη σύγκριση των διάφορων μηχανημάτων. Είναι επίσης κατάλληλη για έναν προσωρινό υπολογισμό της επιβάρυνσης από τους κραδασμούς.

Η στάθμη κραδασμών που αναφέρεται αντιπροσωπεύει τις βασικές χρήσεις του ηλεκτρικού εργαλείου. Σε περίπτωση, όμως, που το ηλεκτρικό εργαλείο θα χρησιμοποιηθεί διαφορετικά, με παρεκκλίνοντα εργαλεία ή χωρίς επαρκή συντήρηση, τότε η στάθμη κραδασμών μπορεί να είναι κι αυτή διαφορετική. Αυτό μπορεί να αυξήσει σημαντικά την επιβάρυνση από τους κραδασμούς κατά τη συνολική διάρκεια ολόκληρου του χρονικού διαστήματος που εργάζεσθε.

Για την ακριβή εκτίμηση της επιβάρυνσης από τους κραδασμούς θα πρέπει να λαμβάνονται επίσης υπόψη και οι χρόνοι κατά τη διάρκεια των οποίων το μηχάνημα

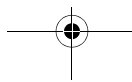
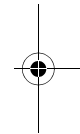
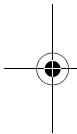



Ελληνικά | 233



βρίσκεται εκτός λειτουργίας ή λειτουργεί, χωρίς όμως στην πραγματικότητα να χρησιμοποιείται. Αυτό μπορεί να μειώσει σημαντικά την επιβάρυνση από τους κραδασμούς κατά τη διάρκεια ολόκληρου του χρονικού διαστήματος που εργάζεσθε.

Γι' αυτό, πριν αρχίσει η δράση των κραδασμών, να καθορίζετε πρόσθετα μέτρα ασφαλείας για την προστασία του χειριστή όπως: συντήρηση του ηλεκτρικού εργαλείου και των εργαλείων που χρησιμοποιείτε, ζέσταμα των χεριών, οργάνωση της εκτέλεσης των διάφορων εργασιών.

Δήλωση συμβατότητας **CE**

Δηλώνουμε υπευθύνως ότι το προϊόν που περιγράφεται στα «Τεχνικά χαρακτηριστικά» εκπληρώνει τους εξής κανονισμούς ή κατασκευαστικές συστάσεις: EN 60745 (συσκευές μπαταρίας) ή αντίστοιχα: EN 60335 (φορτιστές μπαταριών) σύμφωνα με τις διατάξεις των οδηγιών 2006/95/EK, 2004/108/EK, 98/37/EK (έως 28.12.2009), 2006/42/EK (από 29.12.2009).

Τεχνικός φάκελος από:
Robert Bosch GmbH, PT/ESC,
D-70745 Leinfelden-Echterdingen

CE 08

Dr. Egbert Schneider Senior Vice President Engineering	Dr. Eckerhard Strötgen Head of Product Certification
--	--

Dr. Egbert Schneider *Dr. Eckerhard Strötgen*

Robert Bosch GmbH, Power Tools Division
D-70745 Leinfelden-Echterdingen
16.09.2008

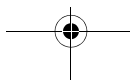

Συναρμολόγηση

Φόρτιση μπαταρίας (βλέπε εικόνα A)

- ▶ **Μη χρησιμοποιήσετε άλλο φορτιστή.** Ο φορτιστής που συμπαραδίδεται μαζί με το ηλεκτρικό εργαλείο είναι εναρμονισμένος με την ενσωματωμένη μπαταρία ιόντων λιθίου.
- ▶ **Προσέξτε την τάση του δικτύου!** Η τάση της πηγής ηλεκτρικού ρεύματος πρέπει να ταυτίζεται με τα στοιχεία στην πινακίδα κατασκευαστή του φορτιστή. Φορτιστές με τάση 230 V μπορούν να λειτουργήσουν και με 220 V.

Υπόδειξη: Η μπαταρία παραδίδεται μερικώς φορτισμένη. Για να εξασφαλίσετε την πλήρη ισχύ της μπαταρίας πρέπει να την φορτίσετε στο φορτιστή πριν την χρησιμοποιήσετε για πρώτη φορά.

Η μπαταρία ιόντων λιθίου μπορεί να φορτιστεί ανά πάσα στιγμή. Η διακοπή της φόρτισης δεν βλάπτει την μπαταρία.

Η μπαταρία ιόντων λιθίου προστατεύεται από μια ολοκληρωτική εκφόρτιση από τη διάταξη «Electronic Cell Protection (ECP)». Όταν αδειάσει η μπαταρία το ηλεκτρικό εργαλείο αποζευγνύεται από μια προστατευτική διάταξη: Το εργαλείο δεν κινείται πλέον.

⚠ ΠΡΟΣΟΧΗ Μετά την αυτόματη απόζευξη του ηλεκτρικού εργαλείου μη συνεχίσετε να πατάτε το διακόπτη ON/OFF. Η μπαταρία μπορεί να υποστεί ζημιά ή βλάβη.

Η φόρτιση αρχίζει μόλις βάλετε το φικ του φορτιστή στην πρίζα δικτύου και ακολούθως τοποθετήσετε το δραπανοκατσάβιδο μπαταρίας στο φορτιστή **10**.

Η ένδειξη κατάστασης φόρτισης **5** δείχνει την πρόοδο της φόρτισης. Κατά τη διάρκεια της φόρτισης η ένδειξη **αναβοσβήνει** με χρώμα πράσινο. Η μπαταρία είναι τελείως φορτισμένη όταν η ένδειξη ανάβει με χρώμα πράσινο **διαρκώς**.

Κατά τη διάρκεια της φόρτισης θερμαίνεται η λαβή του ηλεκτρικού εργαλείου. Αυτό είναι φυσικό.

Όταν δεν πρόκειται να χρησιμοποιήσετε το φορτιστή για ένα σχετικά μεγάλο χρονικό διάστημα, διακόψτε τη σύνδεσή του με το ηλεκτρικό δίκτυο.

Κατά τη διάρκεια της φόρτισης δεν μπορείτε να χρησιμοποιήσετε το ηλεκτρικό εργαλείο. Δεν είναι, λοιπόν, χαλασμένο όταν κατά τη διάρκεια της φόρτισης δεν λειτουργεί.

Δώστε προσοχή στις υποδείξεις απόσυρσης.

Αντικατάσταση εξαρτήματος (βλέπε εικόνα B)

- ▶ **Πριν διεξάγετε οποιαδήποτε εργασία στο ίδιο το ηλεκτρικό εργαλείο (π. χ. συντήρηση, αλλαγή εργαλείου κτλ.) καθώς και όταν πρόκειται να το μεταφέρετε θέστε το διακόπτη αλλαγής φοράς περιστροφής στη μεσαία θέση.** Σε περίπτωση αθέλητης ενεργοποίησης του διακόπτη ON/OFF υπάρχει κίνδυνος τραυματισμού.
- ▶ **Μη χρησιμοποιείτε 2πλές καταβιδόλαμες που είναι μεγαλύτερες από 25 mm.**

Τοποθετήστε την καταβιδόλαμα **1** κατευθείαν στην υποδοχή εργαλείου **2**.

Λειτουργία

Εκκίνηση

Ρύθμιση φοράς περιστροφής (βλέπε εικόνα C)

Με το διακόπτη αλλαγής φοράς περιστροφής **9** μπορείτε ν' αλλάξετε τη φορά περιστροφής του ηλεκτρικού εργαλείου. Αυτό, όμως, δεν είναι δυνατό αν ο διακόπτης ON/OFF **8** είναι πατημένος.

Δεξιόστροφη κίνηση: Για να βιδώσετε πατήστε το διακόπτη αλλαγής φοράς περιστροφής **9** τέρμα αριστερά.

 Η ένδειξη φοράς περιστροφής δεξιόστροφη κίνηση **4** ανάβει όταν ο διακόπτης ON/OFF **8** είναι ενεργοποιημένος και ο κινητήρας εργάζεται.

Αριστερόστροφη κίνηση: Για το λύσιμο ή το ξεβίδωμα βιδών πατήστε το διακόπτη αλλαγής φοράς περιστροφής **9** τέρμα δεξιά.

 Η ένδειξη φοράς περιστροφής αριστερόστροφη κίνηση **6** ανάβει όταν ο διακόπτης ON/OFF **8** είναι ενεργοποιημένος και ο κινητήρας εργάζεται.

Προεπιλογή ροπής στρέψης

Με το δακτύλιο ρύθμισης προεπιλογής ροπής στρέψης **3** μπορείτε να ρυθμίσετε την αναγκαία ροπή στρέψης σε 10 συνολικά βαθμίδες. Το ηλεκτρικό εργαλείο σταματά μόλις επιτευχθεί η ρυθμισμένη ροπή στρέψης.

Βαθμίδα 1:

Μικρή ροπή στρέψης για το βίδωμα βιδών με μικρή διάμετρο ή για βίδωμα σε μαλακά υλικά.

Βαθμίδα 10:

Μεγάλη ροπή στρέψης για το βίδωμα βιδών με μεγάλη διάμετρο ή για βίδωμα σε σκληρά υλικά.

Θέση σε λειτουργία κι εκτός λειτουργίας

Για να **θέσετε σε λειτουργία** το ηλεκτρικό εργαλείο πατήστε το διακόπτη ON/OFF **8** και κρατήστε τον πατημένο.

Η λάμπα **7** ανάβει όταν ο διακόπτης ON/OFF **8** είναι ελαφρά ή τέρμα πατημένος και φωτίζει έτσι την περιοχή εργασίας υπό δυσμενείς συνθήκες φωτισμού.

Για να **θέσετε εκτός λειτουργίας** το ηλεκτρικό εργαλείο αφήστε ελεύθερο το διακόπτη ON/OFF **8**.

Ρύθμιση αριθμού στροφών

Μπορείτε να ρυθμίσετε ομαλά τον αριθμό στροφών του ευρισκόμενου σε λειτουργία ηλεκτρικού εργαλείου, ανάλογα με την πίεση που ασκείτε στο διακόπτη ON/OFF **8**.

Ελαφριά πίεση του διακόπτη ON/OFF **8** έχει σαν αποτέλεσμα χαμηλό αριθμό στροφών. Ο αριθμός στροφών αυξάνει ανάλογα με την αύξηση της πίεσης.

Τελειώς αυτόματη μανδάλωση άξονα (Auto-Lock)

Όταν ο διακόπτης ON/OFF **8** δεν είναι πατημένος είναι μανδλωμένος ο άξονας και μαζί μ' αυτόν και η υποδοχή εργαλείου.

Έτσι μπορείτε να βιδώσετε ακόμη κι αν οι μπαταρίες είναι άδειες και, γενικά, να χρησιμοποιήσετε το ηλεκτρικό εργαλείο σαν κατσαβίδι.

Προστασία από υπερφόρτωση σε εξάρτηση από τη θερμοκρασία

Όταν το ηλεκτρικό εργαλείο χρησιμοποιείται σύμφωνα με τον προορισμό του τότε δεν υπάρχει κίνδυνος υπερφόρτωσης. Σε περίπτωση πολύ ισχυρής επιβάρυνσης, ή όταν υπερσκελιστεί η οριακή θερμοκρασία των 70 °C της



238 | Ελληνικά



μπαταρίας, το ηλεκτρονικό σύστημα αποζευγνύει το ηλεκτρικό εργαλείο, μέχρι η θερμοκρασία της μπαταρίας να μεταβεί πάλι στην εγκριμένη περιοχή της θερμοκρασίας λειτουργίας.

Προστασία από ολοκληρωτική εκφόρτιση

Η μπαταρία ιόντων λιθίου προστατεύεται από μια ολοκληρωτική εκφόρτιση από τη διάταξη «Electronic Cell Protection (ECP)». Όταν αδειάσει η μπαταρία το ηλεκτρικό εργαλείο αποζευγνύεται από μια προστατευτική διάταξη: Το εργαλείο δεν κινείται πλέον.

Υποδείξεις εργασίας

- ▶ **Να βάζετε το ηλεκτρικό εργαλείο επάνω στη βίδα μόνο όταν αυτό βρίσκεται εκτός λειτουργίας.** Περιστρεφόμενα εργαλεία μπορεί να γλιστρήσουν.

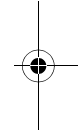
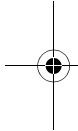

Συντήρηση και Service

Συντήρηση και καθαρισμός

- ▶ **Πριν διεξάγετε οποιαδήποτε εργασία στο ίδιο το ηλεκτρικό εργαλείο (π. χ. συντήρηση, αλλαγή εργαλείου κτλ.) καθώς και όταν πρόκειται να το μεταφέρετε θέστε το διακόπτη αλλαγής φοράς περιστροφής στη μεσαία θέση.** Σε περίπτωση αθέλητης ενεργοποίησης του διακόπτη ON/OFF υπάρχει κίνδυνος τραυματισμού.
- ▶ **Διατηρείτε το ηλεκτρικό εργαλείο και τις σχισμές αερισμού καθαρές για να μπορείτε να εργάζεσθε καλά και ασφαλώς.**

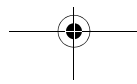



Όταν η μπαταρία δε λειτουργεί πλέον, παρακαλούμε να απευθυνθείτε σ' ένα εξουσιοδοτημένο κατάστημα Service για ηλεκτρικά εργαλεία της Bosch.

Αν παρ' όλες τις επιμελημένες μεθόδους κατασκευής κι ελέγχου το ηλεκτρικό εργαλείο σταματήσει κάποτε να λειτουργεί, τότε η επισκευή του πρέπει να ανατεθεί σ' ένα εξουσιοδοτημένο συνεργείο για ηλεκτρικά εργαλεία της Bosch.

Όταν ζητάτε διασαφητικές πληροφορίες καθώς και όταν παραγγέλνετε ανταλλακτικά πρέπει να αναφέρετε οπωσδήποτε το 10ψήφιο αριθμό ευρετηρίου που αναγράφεται στην πινακίδα κατασκευαστή.

Service και σύμβουλος πελατών

Το Service απαντά στις ερωτήσεις σας σχετικά με την επισκευή και τη συντήρηση του προϊόντος σας καθώς και για τα αντίστοιχα ανταλλακτικά. Λεπτομερή σχέδια και πληροφορίες για τα ανταλλακτικά θα βρείτε στην ηλεκτρονική διεύθυνση:

www.bosch-pt.com

Η ομάδα συμβούλων της Bosch σας υποστηρίζει με ευχαρίστηση όταν έχετε ερωτήσεις σχετικές με την αγορά, τη χρήση και τη ρύθμιση των προϊόντων και ανταλλακτικών.

Ελλάδα

Robert Bosch A.E.
Κηφισσού 162
12131 Περιστέρι-Αθήνα
Tel.: +30 (0210) 57 01 200 KENTPO
Tel.: +30 (0210) 57 70 081 – 83 KENTPO
Fax: +30 (0210) 57 01 263
Fax: +30 (0210) 57 70 080
www.bosch.gr

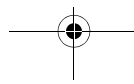
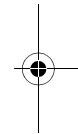
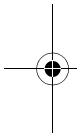

**240 | Ελληνικά**

ABZ Service A.E.
Tel.: +30 (0210) 57 01 375 – 378 SERVICE
Fax: +30 (0210) 57 73 607

Μεταφορά

Η μπαταρία δοκιμάστηκε σύμφωνα με το εγχειρίδιο UN (Ηνωμένων Εθνών) ST/SG/AC.10/11/Rev.3 Μέρος III, ημικεφάλαιο 38.3. Διαθέτει μια αποτελεσματική προστασία ενάντια σε εσωτερική πίεση και βραχυκύκλωμα καθώς και διατάξεις προστασίας από τυχόν βίαιο σπάσιμο και επικίνδυνο ρεύμα αναστροφής.

Το ισοδύναμο της ποσότητας λιθίου που περιέχει η μπαταρία δεν υπερβαίνει τα αντίστοιχα σχετικά όρια. Γι' αυτό η μπαταρία δεν υπόκειται στις εθνικές ή/και στις διεθνείς διατάξεις περί επικινδύνων εμπορευμάτων, ούτε σαν μεμονωμένο εξάρτημα ούτε τοποθετημένη σε μια συσκευή. Όμως, οι διατάξεις περί επικινδύνων εμπορευμάτων μπορεί να αποκτήσουν σημασία όταν μεταφέρονται ταυτόχρονα πολλές μπαταρίες μαζί. Σε μια τέτοια περίπτωση μπορεί να χρειαστεί να παρθούν ιδιαίτερα μέτρα (π.χ. κατά τη συσκευασία). Περισσότερες σχετικές πληροφορίες περιέχει ένα ενημερωτικό έγγραφο στην αγγλική γλώσσα το οποίο μπορείτε να προμηθευτείτε στην εξής ηλεκτρονική διεύθυνση:
<http://purchasing.bosch.com/en/start/Allgemeines/Download/index.htm>.

Απόσυρση

Τα ηλεκτρικά εργαλεία, τα εξαρτήματα και οι συσκευασίες πρέπει να ανακυκλώνονται με τρόπο φιλικό προς το περιβάλλον.

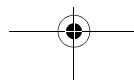
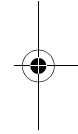
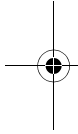

Μόνο για χώρες της ΕΕ:

Μην ρίχνετε τα ηλεκτρικά εργαλεία στα απορρίμματα του σπιτιού σας! Σύμφωνα με την Κοινοτική Οδηγία 2002/96/ΕΚ σχετικά με τις παλαιές ηλεκτρικές και ηλεκτρονικές συσκευές και τη μεταφορά της οδηγίας αυτής σε εθνικό δίκαιο δεν είναι πλέον υποχρεωτικό τα άχρηστα ηλεκτρικά εργαλεία να συλλέγονται ξεχωριστά για να ανακυκλωθούν με τρόπο φιλικό προς το περιβάλλον.

Μπαταρίες/Επαναφορτιζόμενες μπαταρίες:

Li-Ion:
Παρακαλούμε να δώσετε προσοχή στις υποδείξεις στο κεφάλαιο «Μεταφορά», σελίδα 240.

Μη ρίχνετε τις μπαταρίες/τις επαναφορτιζόμενες μπαταρίες στα απορρίμματα του σπιτιού σας, στη φωτιά ή στο νερό. Οι μπαταρίες/οι επαναφορτιζόμενες μπαταρίες πρέπει να συλλέγονται και να ανακυκλώνονται ή να αποσύρονται με τρόπο φιλικό προς το περιβάλλον.

Μόνο για χώρες της ΕΕ:

Σύμφωνα με την Οδηγία 91/157/ΕΟΚ οι χαλασμένες ή αναλωμένες μπαταρίες/οι επαναφορτιζόμενες μπαταρίες πρέπει να ανακυκλώνονται.

Για να αφαιρέσετε την μπαταρία από το ηλεκτρικό εργαλείο, πατήστε και κρατήστε πατημένο το διακόπτη ON/OFF **8** μέχρι να εκφορτιστεί εντελώς η μπαταρία. Ξεβιδώστε τις βίδες στο περίβλημα και αφαιρέστε το κέλυφος του περιβλήματος. Λύστε τις συνδέσεις της μπαταρίας και ακολουθήστε αφαιρέστε την.

Τηρούμε το δικαίωμα αλλαγών.

Güvenlik Talimatı

Elektrikli El Aletleri İçin Genel Uyarı Talimatı

⚠ UYARI Bütün uyarıları ve talimat hükümlerini **okuyun**. Açıklanan uyarılara ve talimat hükümlerine uyulmadığı takdirde elektrik çarpmalarına, yangınlara ve/veya ağır yaralanmalara neden olunabilir. **Bütün uyarıları ve talimat hükümlerini ileride kullanmak üzere saklayın.**

Uyarı ve talimat hükümlerinde kullanılan "Elektrikli El Aleti" kavramı, akım şebekesine bağlı (şebeke bağlantı kablosu ile) aletlerle akü ile çalışan aletleri (akım şebekesine bağlantısı olmayan aletler) kapsamaktadır.

1) Çalışma yeri güvenliği

- Çalıştığınız yeri temiz tutun ve iyi aydınlatın.**
Çalıştığınız yer düzensiz ise ve iyi aydınlatılmamışsa kazalar ortaya çıkabilir.
- Yakınında patlayıcı maddeler, yanıcı sıvı, gaz veya tozların bulunduğu yerlerde elektrikli el aleti ile çalışmayın.** Elektrikli el aletleri, toz veya buharların tutuşmasına neden olabilecek kıvılcımlar çıkarırlar.
- Elektrikli el aleti ile çalışırken çocukları ve başkalarını uzakta tutun.** Dikkatiniz dağılacak olursa aletin kontrolünü kaybedebilirsiniz.

2) Elektrik Güvenliği

- Elektrikli el aletinin bağlantı fişi prize uymalıdır. Fişi hiçbir zaman değiştirmeyin. Koruyucu topraklanmış elektrikli el aletleri ile birlikte adaptör fiş kullanmayın.** Değiştirilmemiş fiş ve uygun priz elektrik çarpma tehlikesini azaltır.

b) Borular, kalorifer petekleri, ısıtıcılar ve buzdolapları gibi topraklanmış yüzeylerle bedensel temasa gelmekten kaçınınız. Bedeniniz topraklandığı anda büyük bir elektrik çarpma tehlikesi ortaya çıkar.

c) Aleti yağmur altında veya nemli ortamlarda bırakmayınız. Suyun elektrikli el aleti içine sızması elektrik çarpma tehlikesini artırır.

d) Elektrikli el aletini kablosundan tutarak taşımayınız, kabloyu kullanarak asmayınız veya kablodan çekerek fişi çıkarmayınız. Kabloyu ısıdan, yağdan, keskin kenarlı cisimlerden veya aletin hareketli parçalarından uzak tutunuz. Hasarlı veya dolaşmış kablo elektrik çarpma tehlikesini artırır.

e) Bir elektrikli el aleti ile açık havada çalışırken, mutlaka açık havada kullanılmaya uygun uzatma kablosu kullanınız. Açık havada kullanılmaya uygun uzatma kablosunun kullanılması elektrik çarpma tehlikesini azaltır.

f) Elektrikli el aletinin nemli ortamlarda çalıştırılması şartsa, mutlaka arıza akımı koruma şalteri kullanınız. Arıza akımı koruma şalterinin kullanımı elektrik çarpma tehlikesini azaltır.

3) Kişilerin Güvenliği

a) Dikkatli olun, ne yaptığınıza dikkat edin, elektrikli el aleti ile işinizi makul bir tempo ve yöntemle yürütün. Yorgunsanız, aldığınız hapların, ilaçların veya alkolün etkisinde iseniz elektrikli el aletini kullanmayınız. Aleti kullanırken bir anki dikkatsizlik önemli yaralanmalara neden olabilir.

244 | Türkçe

b) Daima kişisel koruyucu donanım ve bir koruyucu gözlük kullanın. Elektrikli el aletinin türü ve kullanımına uygun olarak; toz maskesi, kaymayan iş ayakkabıları, koruyucu kask veya koruyucu kulaklık gibi koruyucu donanım kullanımı yaralanma tehlikesini azaltır.

c) Aleti yanlışlıkla çalıştırmaktan kaçının. Akım ikmal şebekesine ve/veya aküye bağlamadan, elinize alıp taşımadan önce elektrikli el aletinin kapalı olduğundan emin olun. Elektrikli el aletini parmağınız şalter üzerinde dururken taşırsanız ve alet açıkken fişi prize sokarsanız kazalara neden olabilirsiniz.

d) Elektrikli el aletini çalıştırmadan önce ayar aletlerini veya anahtarları aletten çıkarın. Aletin dönen parçaları içinde bulunabilecek bir yardımcı alet yaralanmalara neden olabilir.

e) Çalışırken bedeniniz anormal durumda olmasın. Çalışırken duruşunuz güvenli olsun ve dengenizi her zaman koruyun. Bu sayede aleti beklenmedik durumlarda daha iyi kontrol edebilirsiniz.

f) Uygun iş elbiseleri giyin. Geniş giysiler giymeyin ve takı takmayın. Saçlarınızı, giysilerinizi ve eldivenlerinizi aletin hareketli parçalarından uzak tutun. Bol giysiler, uzun saçlar veya takılar aletin hareketli parçaları tarafından tutulabilir.

g) Toz emme donanımı veya toz tutma tertibatı kullanırken, bunların bağlı olduğundan ve doğru kullanıldığından emin olun. Toz emme donanımının kullanımı tozdan kaynaklanabilecek tehlikeleri azaltır.

4) Elektrikli el aletlerinin özenle kullanımı ve bakımı

a) Aleti aşırı ölçüde zorlamayın. Yaptığınız işe uygun elektrikli el aletleri kullanın. Uygun performanslı elektrikli el aleti ile, belirlenen çalışma alanında daha iyi ve güvenli çalışırsınız.

b) Şalteri bozuk olan elektrikli el aletini kullanmayın. Açılıp kapanamayan bir elektrikli el aleti tehlikelidir ve onarılmalıdır.

c) Alette bir ayarlama işlemine başlamadan ve/veya aküyü çıkarmadan önce, herhangi bir aksesuarı değiştirirken veya aleti elinizden bırakırken fişi prizden çekin. Bu önlem, elektrikli el aletinin yanlışlıkla çalışmasını önler.

d) Kullanım dışı duran elektrikli el aletlerini çocukların ulaşamayacağı bir yerde saklayın. Aleti kullanmayı bilmeyen veya bu kullanım kılavuzunu okumayan kişilerin aletle çalışmasına izin vermeyin. Deneyimsiz kişiler tarafından kullanıldığında elektrikli el aletleri tehlikelidir.

e) Elektrikli el aletinizin bakımını özenle yapın. Elektrikli el aletinizin kusursuz olarak işlev görmesini engelleyebilecek bir durum olup olmadığını, hareketli parçaların kusursuz olarak işlev görüp görmediklerini ve sıkışıp sıkışmadıklarını, parçaların hasarlı olup olmadığını kontrol edin. Aleti kullanmaya başlamadan önce hasarlı parçaları onartın. Birçok iş kazası elektrikli el aletlerinin kötü bakımından kaynaklanır.

f) Kesici uçları daima keskin ve temiz tutun. Özenle bakımı yapılmış keskin kenarlı kesme uçlarının malzeme içinde sıkışma tehlikesi daha azdır ve daha rahat kullanım olanağı sağlarlar.

**246 | Türkçe**

g) Elektrikli el aletini, aksesuarı, uçları ve benzerlerini, bu özel tip alet için öngörülen talimata göre kullanın. Bu sırada çalışma koşullarını ve yaptığınız işi dikkate alın. Elektrikli el aletlerinin kendileri için öngörülen alanın dışında kullanılması tehlikeli durumlara neden olabilir.

5) Akülü aletlerin özenli bakımı ve kullanımı

a) Aküyü sadece üreticinin tavsiye ettiği şarj cihazı ile şarj edin. Bir akünün şarjına uygun olarak üretilmiş şarj cihazı başka bir akünün şarjı için kullanılırsa yangın tehlikesi ortaya çıkar.

b) Sadece ilgili elektrikli el aleti için öngörülen aküleri kullanın. Başka akülerin kullanımı yaralanmalara ve yangınlara neden olabilir.

c) Kullanılmayan aküyü büro ataçları, madeni bozuk paralar, anahtarlar, çiviler, vidalar veya metal nesnelere uzak tutun. Bunlar köprüleme yaparak kontaklara neden olabilir. Akü kontakları arasındaki bir kısa devre yanmalara veya yangınlara neden olabilir.

d) Yanlış kullanım durumunda aküden sıvı dışarı sızabilir. Bu sıvı ile temasa gelmeyin. Yanlışlıkla temasa gelerseniz su ile iyice yıkayın. Eğer sıvı gözlerinize gelecek olursa hemen bir hekime başvurun. Dışarı sızan akü sıvısı cilt tahrişlerine ve yanmalara neden olabilir.

6) Servis

a) Elektrikli el aletinizi sadece yetkili personele ve orijinal yedek parça kullanma koşulu ile onartın. Bu sayede aletin güvenliğini sürekli hale getirirsiniz.

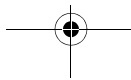
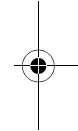
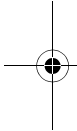

Vidalama makinesi güvenlik talimatı

- ▶ **Vidanın görünmeyen elektrik kablolarına veya aletin kendi şebeke bağlantı kablosuna rastlama olasılığı bulunan işleri yaparken elektrikli el aletini izolasyonlu tutamağından tutun.** Vidanın gerilim ileten kablolarla teması elektrikli el aletinin metal parçalarını da elektrik akımına maruz bırakabilir ve elektrik çarpmasına neden olabilir.
- ▶ **Elektrikli el aletini sıkıca tutun.** Vidalar takılıp sökülürken kısa süreli yüksek reaksiyon momentleri ortaya çıkabilir.
- ▶ **İş parçasını emniyete alın.** Bir germe tertibatı veya mengene ile sabitlenen iş parçası elle tutmaya oranla daha güvenli tutulur.
- ▶ **Aletin kendinde bir çalışma yapmadan önce (örneğin bakım ve uç değiştirme işlerinden önce), aleti bir yere taşıırken veya saklarken her defasında dönme yönü değiştirme şalterini orta konuma getirin.** Açma/kapama şalterine yanlışlıkla basıldığında yaralanma tehlikesi ortaya çıkabilir.
- ▶ **Aletin yanlışlıkla çalışmaması için gerekli önlemleri alın. Aküyü yerine yerleştirmeden önce açma/kapama şalterinin kapalı pozisyonda bulunduğundan emin olun.** Parmağınız açma/kapama şalteri üzerinde iken elektrikli el aletini taşırsanız veya elektrikli el aleti çalışır durumda iken aküyü takmak isterseniz kazalara neden olabilirsiniz.
- ▶ **Aküyü açmayın.** Kısa devre tehlikesi vardır.



Elektrikli el aletini, örneğin sürekli güneş ışını da dahil olmak üzere aşırı sıcaktan ve ateşten koruyun. Patlama tehlikesi vardır.

248 | Türkçe

- ▶ **Hasar gördüklerinde veya usulüne uygun kullanılmadıklarında aküler buhar çıkarabilir. Çalıştığınız yeri havalandırın ve şikayet olursa hekime başvurun.** Akülerden çıkan buharlar nefes yollarını tahriş edebilir.
- ▶ **Arızalı akülerde sızıntı olabilir ve bu sızıntı çevreye yayılabilir. Lütfen ilgili parçaları kontrol edin.** Üzerinde sıvı olan parçaları temizleyin veya gerekiyorsa değiştirin.

Şarj cihazları için güvnelik talimatı**Şarj cihazını yağmur ve neme karşı koruyun.**

Şarj cihazının içine su sızması elektrik çarpma tehlikesini artırır.

- ▶ **Yabancı marka akü şarj etmeyin.** Bu şarj cihazı sadece teknik veriler bölümünde belirtilen gerilime sahip Bosch Li-Ionen-Akülerin şarjına uygundur. Yabancı marka akülerin şarjı yangın ve patlama tehlikesinin oluşmasına neden olabilir.
- ▶ **Şarj cihazını temiz tutun.** Kirlenme nedeniyle elektrik çarpma tehlikesi ortaya çıkar.
- ▶ **Her kullanımdan önce şarj cihazını, kabloyu ve fişi kontrol edin. Hasar tespit ederseniz şarj cihazını kullanmayın. Şarj cihazını kendiniz açmayın, sadece kalifiye elemanlara veya uzmanlara açtırın ve sadece orijinal yedek parçalar kullanın.** Hasarlı şarj cihazı, kablo ve fişler elektrik çarpma tehlikesini artırır.
- ▶ **Şarj cihazını kolay tutuşan zeminlerde kullanmayın (örneğin kağıt, tekstil malzemesi vb.).** Şarj işlemi sırasında şarj cihazında meydana gelen ısınma yangın tehlikesi doğurur.

Fonksiyon tanımı



Bütün uyarıları ve talimat hükümlerini okuyun. Açıklanan uyarılara ve talimat hükümlerine uyulmadığı takdirde elektrik çarpmalarına, yangınlara ve/veya ağır yaralanmalara neden olunabilir.

Usulüne uygun kullanım

Bu alet vidaların takılması ve sökülmesi için geliştirilmiştir. Elektrikli el aletini; bütün fonksiyonlarını öğrendikten, bunları tam olarak uygulayabildikten sonra veya ilgili talimatı hükümlerini öğrendikten sonra kullanın.

Şekli gösterilen elemanlar

Şekli gösterilen elemanların numaraları grafik sayfasındaki elektrikli el aleti resmindeki numaralarla aynıdır.

- 1 Vidalama ucu*
- 2 Uç kovani
- 3 Tork ön seçimi ayar halkası
- 4 Dönme yönü göstergesi, sağa dönüş
- 5 Akü şarj durumu göstergesi
- 6 Dönme yönü göstergesi, sola dönüş
- 7 "Power Light" lambası
- 8 Açma/kapama şalteri
- 9 Dönme yönü değiştirme şalteri
- 10 Şarj cihazı

***Şekli gösterilen veya tanımlanan aksesuar standart teslimat kapsamında değildir. Aksesuarın tümünü aksesuar programımızda bulabilirsiniz.**

250 | Türkçe**Teknik veriler**

Akülü vidalama makinesi		PSR 7,2 LI
Ürün kodu		3 603 J57 7..
Anma gerilimi	V=	7,2
Boştaki devir sayısı	dev/dak	0–230
ISO 5393'e göre sert/yumuşak vidalamada maksimum tork	Nm	10/6
maks. vidalama-Ø	mm	6
Ağırlığı EPTA-Procedure 01/2003'e göre	kg	0,5
Akü		Li-Ionen
Kapasitesi	Ah	1,3
Akü hücrelerinin sayısı		2
Şarj cihazı		
Ürün kodu		2 607 225 553 (EU) 2 607 225 555 (UK)
Şarj süresi	h	5,0

Lütfen elektrikli el aletinizin tip etiketi üzerindeki ürün koduna dikkat edin. Tek tek aletlerin ticari kodları değişik olabilir.

Gürültü/Titreşim bilgisi

Ölçüm değerleri EN 60745'e göre tespit edilmiştir.

Aletin A olarak değerlendirilen ses basıncı seviyesi tipik olarak 70 dB(A)'dan düşüktür. Tolerans K = 3 dB.

Çalışma sırasında gürültü seviyesi 80 dB(A)'yı aşabilir.

Koruyucu kulaklık kullanın!

Toplam titreşim değeri (üç yönün vektör toplamı) EN 60745'e göre tespit edilmiştir:

Vidalama: Titreşim emisyon değeri $a_h < 2,5 \text{ m/s}^2$, tolerans $K = 1,5 \text{ m/s}^2$.

Bu talimatta belirtilen titreşim seviyesi EN 60745'e göre normlandırılmış bir ölçme yöntemi ile tespit edilmiştir ve elektrikli el aletlerinin karşılaştırılmasında kullanılabilir. Bu değer geçici olarak titreşim seviyesinin tahmin edilmesine uygundur.

Belirtilen titreşim seviyesi elektrikli el aletinin temel kullanım alanlarını temsil eder. Ancak elektrikli el aleti başka kullanım alanlarında kullanılırken, farklı uçlarla kullanılırken veya yetersiz bakımla kullanılırken, titreşim seviyesi belirtilen değerden farklı olabilir. Bu da toplam çalışma süresi içindeki titreşim yükünü önemli ölçüde artırabilir.

Titreşim yükünü tam olarak tahmin edebilmek için aletin kapalı olduğu veya çalıştığı halde kullanılmadığı süreler de dikkate alınmalıdır. Bu, toplam çalışma süresi içindeki titreşim yükünü önemli ölçüde azaltabilir.

Titreşimin kullanıcıya bindirdiği yük için önceden ek güvenlik önlemleri alın. Örneğin: Elektrikli el aletinin ve uçların bakımı, ellerin sıcak tutulması, iş aşamalarının organize edilmesi.

252 | Türkçe

Uygunluk beyanı 

Tek sorumlu olarak "Teknik veriler" bölümünde tanımlanan bu ürünün: 2006/95/AT, 2004/108/AT ile 98/37/AT yönetmelikleri hükümleri uyarınca (28.12.2009 tarihine kadar) ve 2006/42/AT yönetmelikle hükümleri uyarınca da (29.12.2009 tarihinden itibaren) EN 60745'e (akülü aletler) ve EN 60335 (akü şarj cihazları) normlarına veya bu normlara ait normatif belgelere uygunluğunu beyan ederiz.

Teknik belgelerin bulunduğu merkez:
Robert Bosch GmbH, PT/ESC,
D-70745 Leinfelden-Echterdingen

CE 08

Dr. Egbert Schneider Senior Vice President Engineering	Dr. Eckerhard Strötgen Head of Product Certification
--	--

Dr. Egbert Schneider *Dr. Eckerhard Strötgen*

Robert Bosch GmbH, Power Tools Division
D-70745 Leinfelden-Echterdingen
16.09.2008

Montaj**Akünün şarjı (Bakınız: Şekil A)**

- **Başka şarj cihazı kullanmayın.** Aletle birlikte teslim edilen şarj cihazı, alet içindeki Li-Ionen akülere uyarlanmıştır.

- **Şebeke gerilimine dikkat edin!** Akım kaynağının gerilimi şarj cihazının tip etiketindeki verilere uymalıdır. 230 V işaretli şarj cihazları 220 V ile de çalıştırılabilir.

Açıklama: Akü kısmı şarjlı olarak teslim edilir. Aküden tam performansı elde edebilmek için ilk kullanımdan önce aküyü şarj cihazında tam olarak şarj edin.

Li-Ionen aküler kullanım ömürleri kısalmadan istendiği zaman şarj edilebilir. Şarj işleminin kesilmesi aküye zarar vermez.

Li-Ionen-Aküler Electronic Cell Protection (ECP) sistemi ile derin şarja karşı korumalıdır. Akü deşarj olduğunda elektrikli el aleti koruyucu kesme sistemi ile kapatılır: Elektrikli el aleti artık hareket etmez.

⚠ DİKKAT Elektrikli el aletiniz otomatik olarak kapandığında artık açma/kapama şalterine basmayın. Aksi takdirde akü hasar görebilir.

Şarj cihazının şebeke fişi prize takıldıktan ve akülü vidalama makinesi şarj cihazına **10** yerleştirildikten sonra şarj işlemi başlar.

Akü şarj durumu göstergesi **5** şarj sürecini gösterir. Şarj süreci boyunca gösterge yeşil olarak **yanıp söner**.

Gösterge **sürekli olarak** yeşil yandığında akü tam olarak şarj olmuş demektir.

Şarj işlemi sırasında elektrikli el aletinin tutamağı ısınır. Bu normaldir.

Uzun süre kullanmayacaksanız şarj cihazını şebekeden ayırın.

Elektrikli el aleti şarj işlemi esnasında kullanılamaz; şarj işlemi esnasında işlev görmeyen elektrikli el aleti arızalı değildir.

Tasfiye konusundaki talimat hükümlerine uyun.

Uç deęiřtirme (Bakınız: Őekil B)

- **Aletin kendinde bir alıřma yapmadan nce (rneęin bakım ve u deęiřtirme iřlerinden nce), aleti bir yere tařırken veya saklarken her defasında dnme yn deęiřtirme Őalterini orta konuma getirin.**
Ama/kapama Őalterine yanlıřlıkla basıldıęında yaralanma tehlikesi ortaya ıkabilir.

- **25 mm'den uzun 2 taraflı tornavida ucu kullanmayın.**

Vidalama ucunu **1** doęrudan u kovanına **2** yerleřtirin.

İřletim

alıřtırma

Dnme ynnn ayarlanması (Bakınız: Őekil C)

Dnme yn deęiřtirme Őalteri **9** ile elektrikli el aletinin dnme ynn deęiřtirebilirsiniz. Ancak ama/kapama Őalteri **8** basılı iken bu mmkn deęildir.

Saęa dnř: Vidaları takmak iin dnme yn deęiřtirme Őalterini **9** sola doęru sonuna kadar bastırın.

 Saęa dnř yn gstergesi **4** ama/kapama Őalteri **8** basılı iken ve motor alıřırken yanar.

Sola dnř: Vidaları gevřetmek veya skmek iin dnme yn deęiřtirme Őalterini **9** sonuna kadar saęa bastırın.

 Sola dnř yn gstergesi **6** ama/kapama Őalteri **8** basılı iken ve motor alıřırken yanar.

Tork ön seçimi

Tork ön seçim ayar halkası **3** ile gerekli torku 10 kademesiz olarak ayarlayabilirsiniz. Ayarlanan torka ulaşıldığında elektrikli el aleti durdurulur.

Kademe 1:

Küçük çaplı vidaların takılması veya yumuşak malzemede küçük tork.

Kademe 10:

Büyük çaplı vidaların takılması veya sert malzemede büyük tork.

Açma/kapama

Aleti **çalıştırmak** için açma/kapama şalterine **8** basın ve şalteri basılı tutun.

Lamba **7** açma/kapama şalteri **8** hafifçe veya tam olarak basılı iken yanar ve elverişsiz aydınlatma koşullarında çalışma yerinin aydınlatılmasını sağlar.

Elektrikli el aletini **kapamak** için açma/kapama şalterini **8** bırakın.

Devir sayısının ayarlanması

Açma/kapama şalterine **8** basma durumunuza göre elektrikli el aleti açıkken devir sayısını kademeler halinde ayarlayabilirsiniz.

Açma/kapama şalteri **8** üzerine hafif bir bastırma kuvveti uygulanınca alet düşük devir sayısı ile çalışır. Bastırma kuvveti yükseldikçe devir sayısı da yükselir.

Tam otomatik mil kilitleme (Auto-Lock)

Açma/kapama şalteri **8** basılı değilken matkap mili ve uç kovanı kilitlidir.

Bu sayede vidalar akü boş durumda iken de vidalanabilir veya alet tornavida olarak kullanılabilir.

256 | Türkçe**Sıcaklığa bağlı aşırı zorlanma emniyeti**

Usulüne uygun olarak kullanıldığında elektrikli el aleti aşırı ölçüde zorlanamaz. Aşırı zorlama durumunda veya 70 °C'lik müsaade edilen akü sıcaklığının aşılması durumunda tekrar optimal işletim sıcaklığına ulaşıncaya kadar elektrikli el aletinin elektronik sistemi aleti kapatır.

Derin şarj emniyeti

Li-Ionen-Aküler Electronic Cell Protection (ECP) sistemi ile derin şarja karşı korumalıdır. Akü deşarj olduğunda elektrikli el aleti koruyucu kesme sistemi ile kapatılır: Elektrikli el aleti artık hareket etmez.

Çalışırken dikkat edilecek hususlar

- ▶ **Elektrikli el aletini daima kapalı durumda vida üzerine yerleştirin.** Dönmekte olan uçlar kayabilir.

Bakım ve servis**Bakım ve temizlik**

- ▶ **Aletin kendinde bir çalışma yapmadan önce (örneğin bakım ve uç değiştirme işlerinden önce), aleti bir yere taşıırken veya saklarken her defasında dönme yönü değiştirme şalterini orta konuma getirin.** Açma/kapama şalterine yanlışlıkla basıldığında yaralanma tehlikesi ortaya çıkabilir.
- ▶ **İyi ve güvenli çalışabilmek için elektrikli el aletini ve havalandırma deliklerini daima temiz tutun.**



Akü artık işlev görmüyorsa lütfen Bosch elektrikli el aletleri için yetkili bir servise başvurun.

Dikkatli biçimde yürütülen üretim ve test yöntemlerine rağmen elektrikli el aleti arıza yapacak olursa, onarım Bosch elektrikli aletleri için yetkili bir serviste yapılmalıdır.

Bütün başvuru ve yedek parça siparişlerinizde mutlaka aletinizin tip etiketindeki 10 haneli ürün kodunu belirtiniz.

Müşteri servisi ve müşteri danışmanlığı

Müşteri servisleri ürününüzün onarım ve bakımı ile yedek parçalarına ait sorularınızı yanıtladılır. Demonte görünüşler ve yedek parçalara ait bilgileri şu adreste de bulabilirsiniz:

www.bosch-pt.com

Bosch müşteri servisi timi satın alacağınız ürünün özellikleri, bu ürünün kullanımı ve ayar işlemleri hakkındaki sorularınız ile yedek parçalarına ait sorularınızı memnuniyetle yanıtladılır.

Türkçe

Bosch San. ve Tic. A.S.
Ahi Evran Cad. No:1 Kat:22
Polaris Plaza
80670 Maslak/Istanbul
Müşteri Danışmanı: +90 (0212) 335 06 66
Müşteri Servis Hattı: +90 (0212) 335 07 52

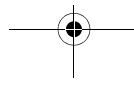
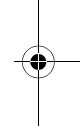
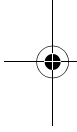

258 | Türkçe**Nakliye**

Akü UN-Kitapçığı ST/SG/AC.10/11/Rev.3 Kısım III, alt bölüm 38.3'e göre test edilmiştir. Akünün ayrıca iç basınç, kısa devre, zorlama ile kırılma ve tehlikeli geri akıma karşı etkin koruma sistemi vardır.

Akü içinde bulunan lityum miktarı yasal sınırların altındadır. Bu nedenle akü ne tek başına ne de bir alet içinde iken ulusal ve uluslararası tehlikeli madde kapsamına girer. Ancak çok sayıda akünün naklinde tehlikeli madde hükümleri önem kazanabilir. Bu gibi durumlarda özel koşulların sağlanması (örneğin ambalajda) gerekli olabilir. Bu konuda daha ayrıntılı bilgiyi aşağıdaki İnternet adresinde İngilizce olarak bulabilirsiniz: <http://purchasing.bosch.com/en/start/Allgemeines/Download/index.htm>.

Tasfiye

Elektrikli el aleti, aksesuar ve ambalaj malzemesi çevre dostu bir yöntemle tasfiye edilmek üzere tekrar kazanım merkezine gönderilmelidir.

Sadece AB üyesi ülkeler için:

Elektrikli el aletini evsel çöplerin içine atmayın!
Elektrikli el aletleri ve eski elektronik aletlere ilişkin 2002/96/AT sayılı Avrupa Birliği yönetmeliği ve bunların tek tek ülkelerin hukuklarına uyarlanması uyarınca, kullanım ömrünü tamamlamış elektrikli el aletleri ayrı ayrı toplanmak ve çevre dostu bir yöntemle tasfiye edilmek üzere yeniden kazanım merkezlerine gönderilmek zorundadır.

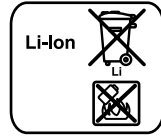
Aküler/Bataryalar:**Li-Ion:**

Lütfen bölüm "Nakliye", sayfa içindeki uyarılara uyun 258.

Aküleri ve bataryaları evsel çöplerin içine, ateşe veya suya atmayın. Aküler ve bataryalar toplanmak, tekrar kazanım işlemine tabi tutulmak ve çevre dostu bir yöntemle tasfiye edilmek zorundadır.

Sadece AB üyesi ülkeler için:

91/157/AET Yönetmeliği uyarınca arızalı veya kullanım ömrünü tamamlamış aküler ve bataryalar yeniden kazanım işlemine tabi tutulmak zorundadır.

Aküyü elektrikli el aletinden çıkarmak için, akü tam olarak boş alıncaya kadar açma/kapama şalterine **8** basın. Gövdedeki vidaları sökün ve gövde muhafazasını alın. Akü bağlantılarını ayırın ve aküyü dışarı çıkarın.

Değişiklik haklarımız saklıdır.