

- Ⓓ Montage- und Betriebsanleitung • ⒼⒸ Assembly and Operating Instructions
- Ⓕ Instructions de montage et d'utilisation • Ⓔ Instrukcijas de uso y montaje
- Ⓖ Instrukções de montagem e modo de utilização
- Ⓗ Montage- en gebruiksaanwijzing • Ⓘ Istruzioni di montaggio e d'uso
- Ⓒ Monterings- och bruksanvisning • Ⓙ Instrukcja obsługi i montażu
- Ⓕ Összeszerelési és használati útmutató

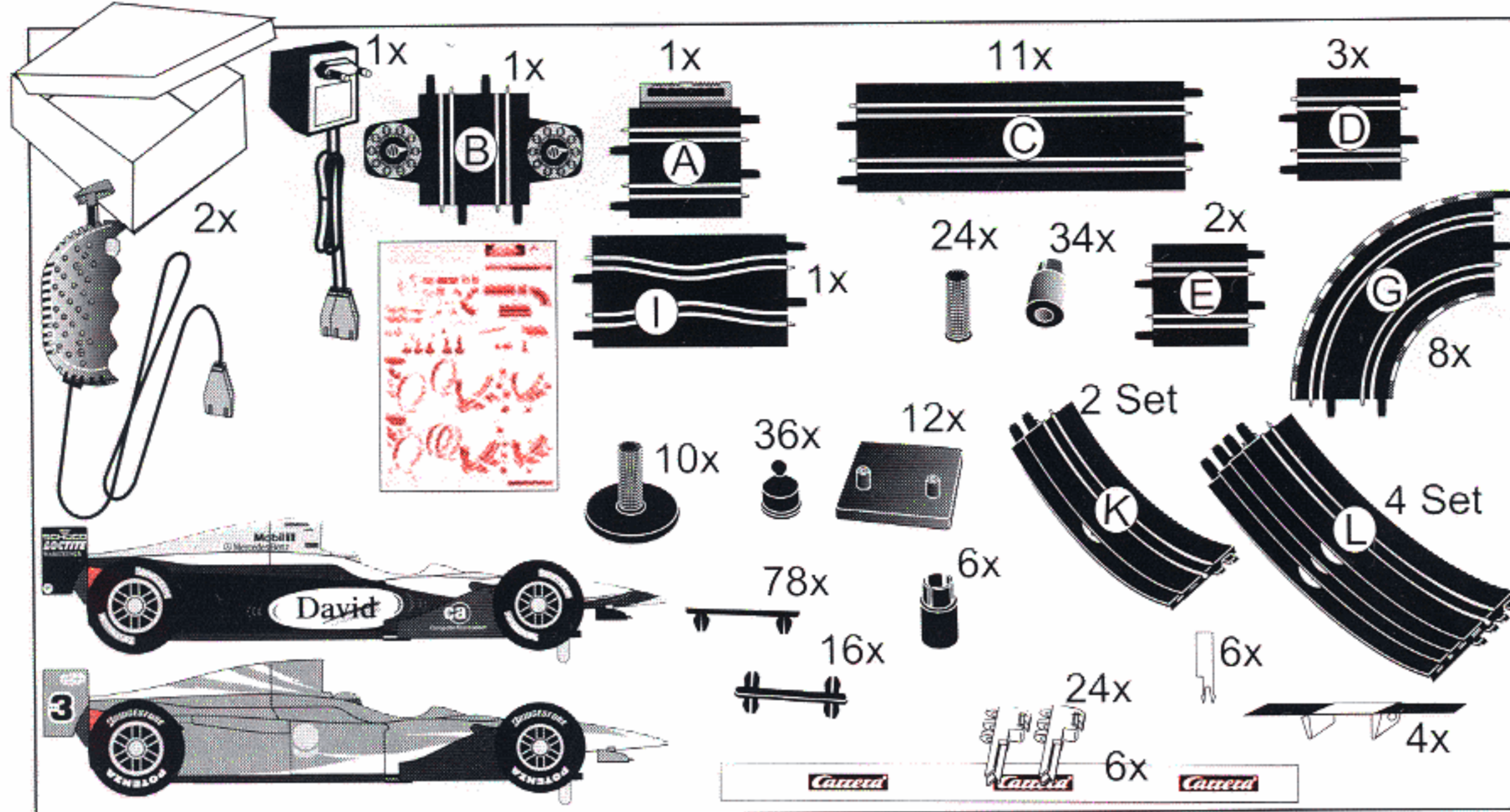

Stadlbauer • Marketing + Vertrieb Ges.m.b.H.
 Magazinstraße 4 • 5027 Salzburg • Austria
 Internet: <http://www.carrera-toys.de>
<http://www.carreraclub.com>



F1 Championship 60520

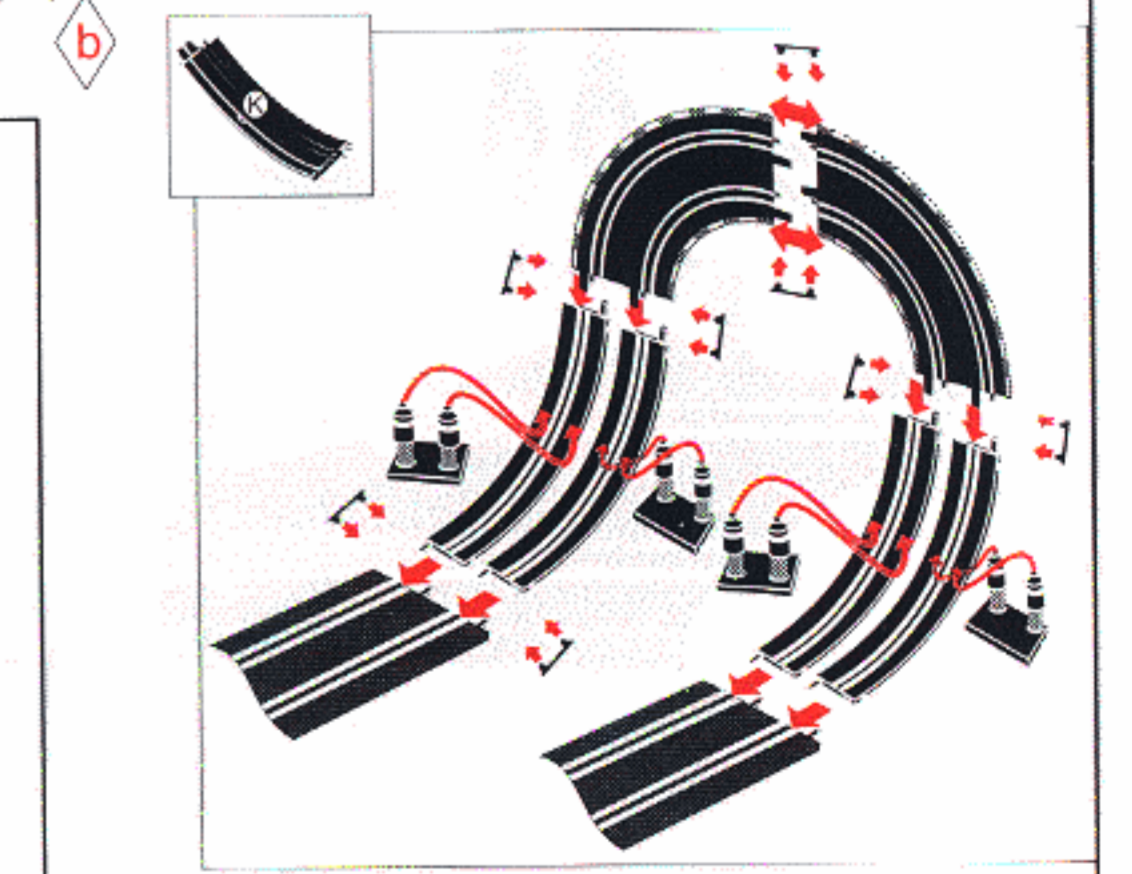
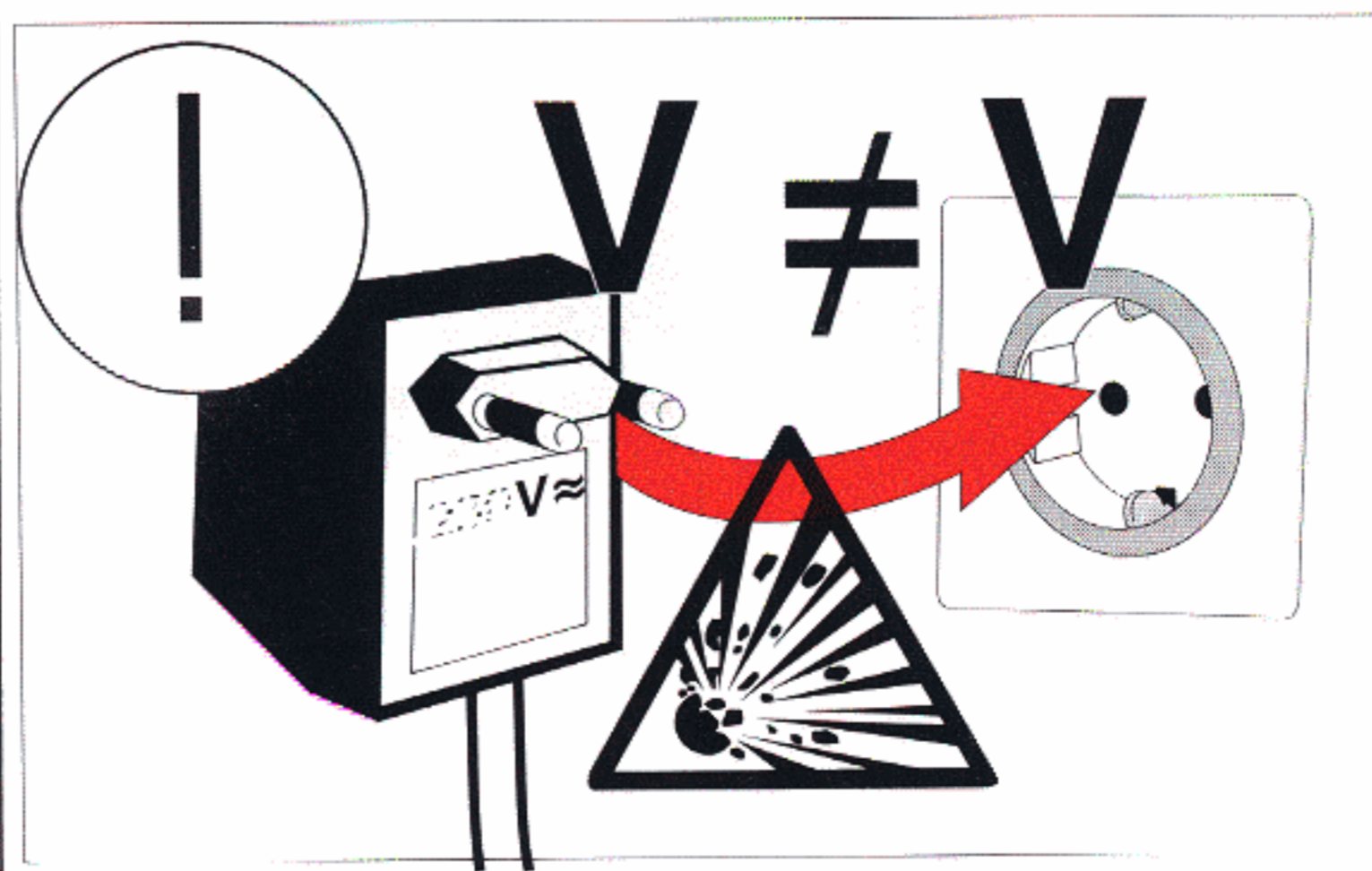
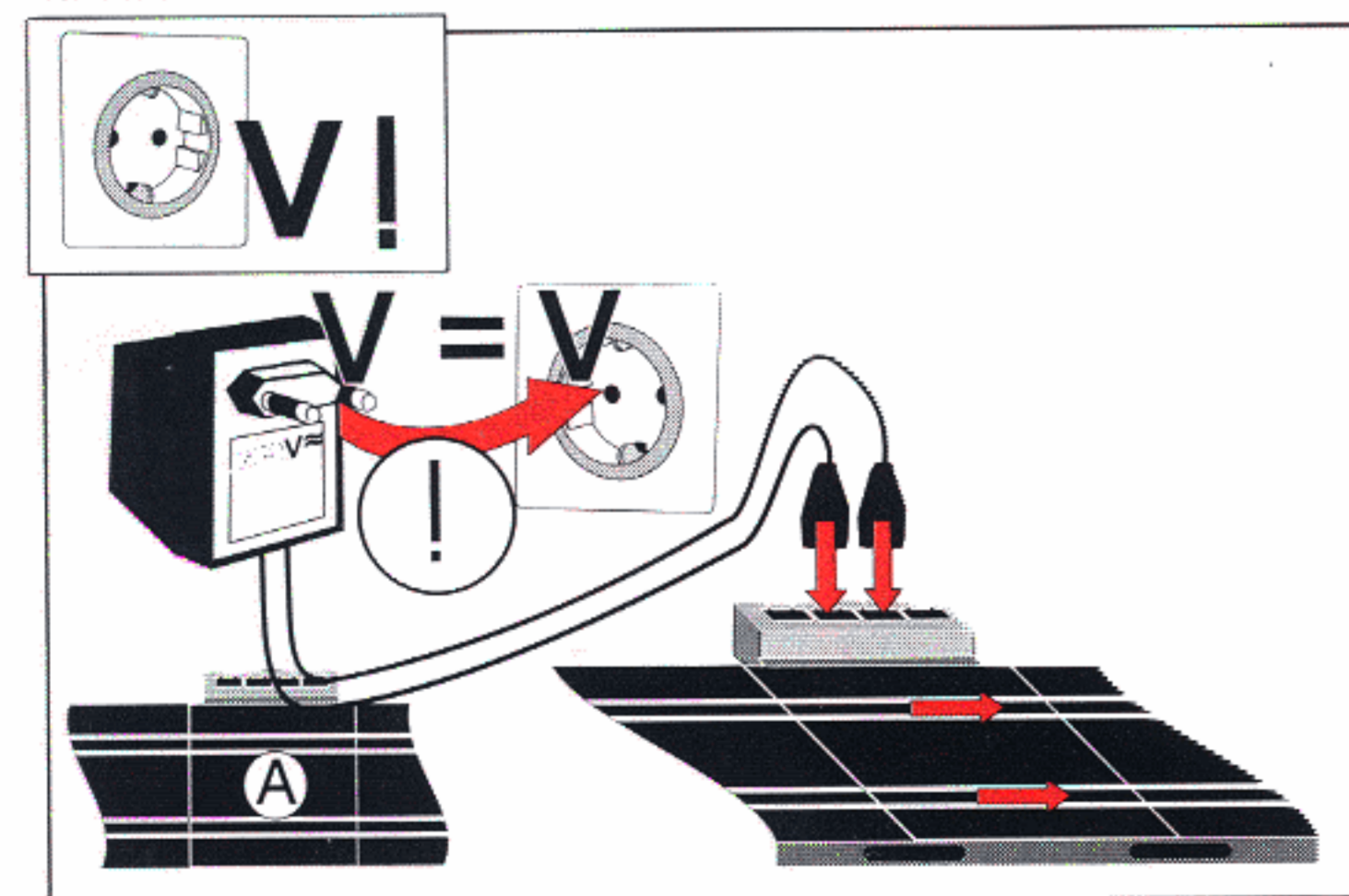
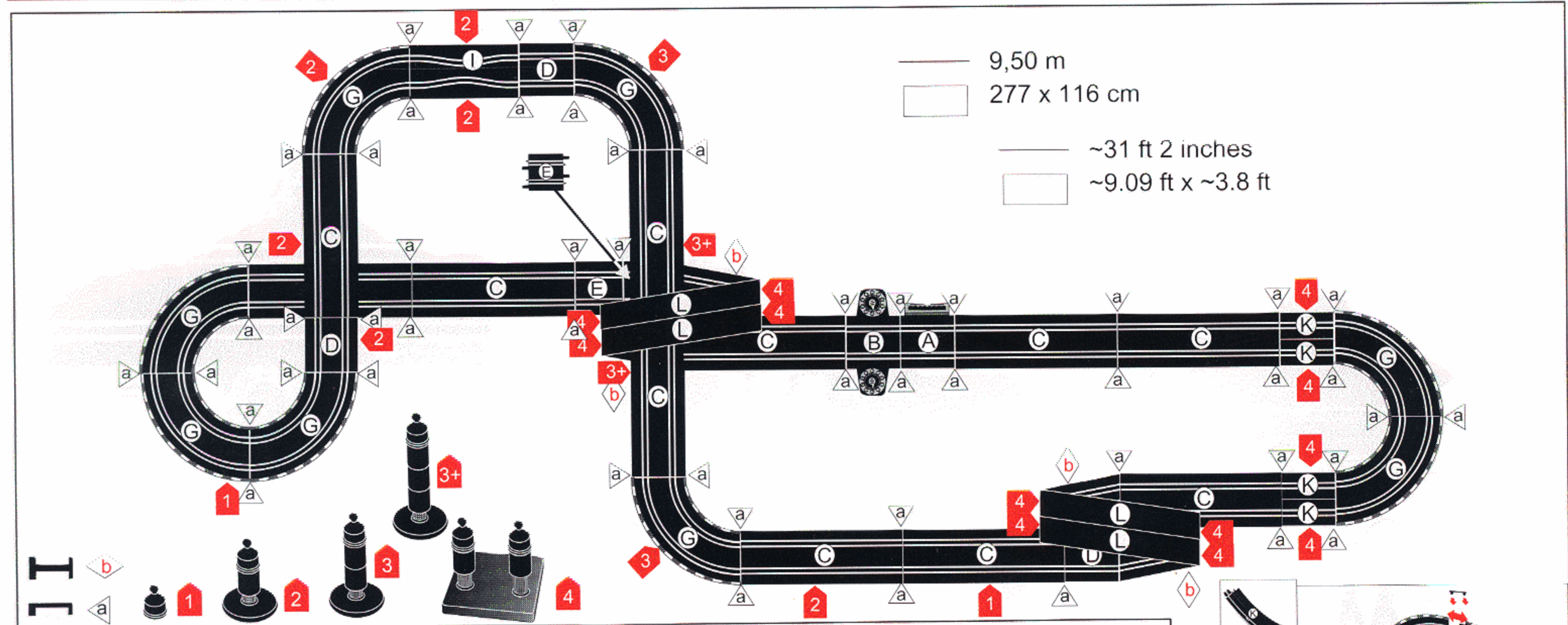
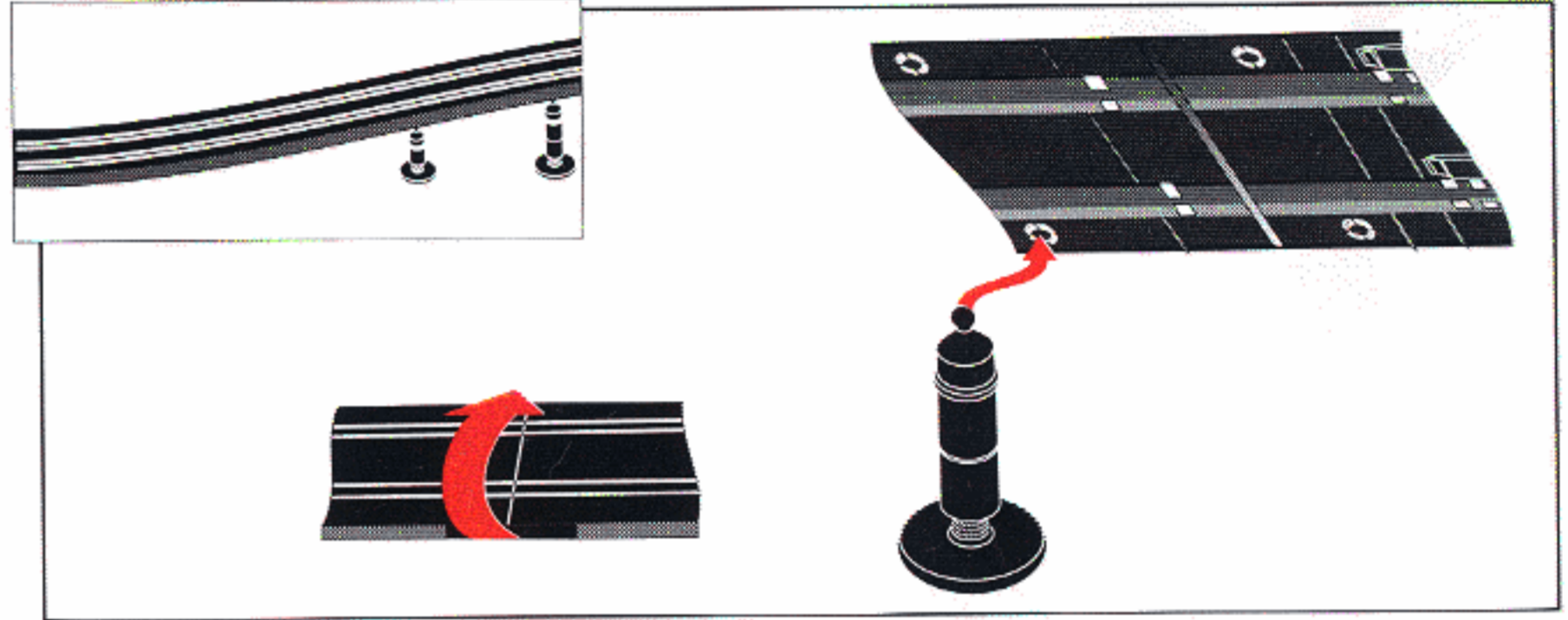
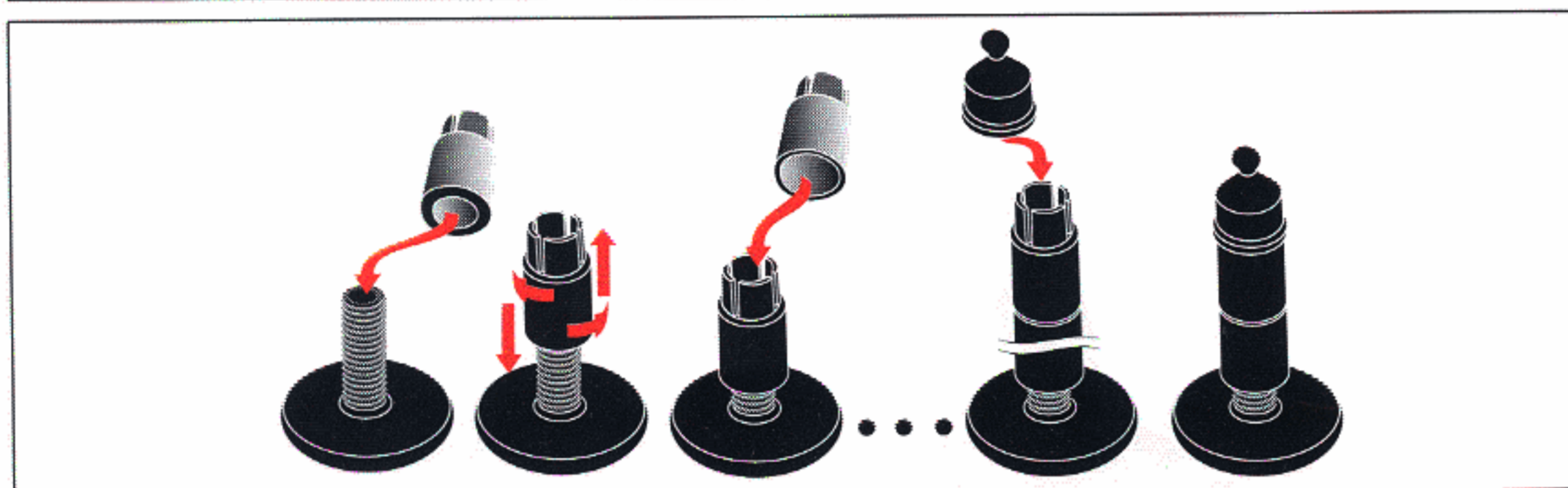
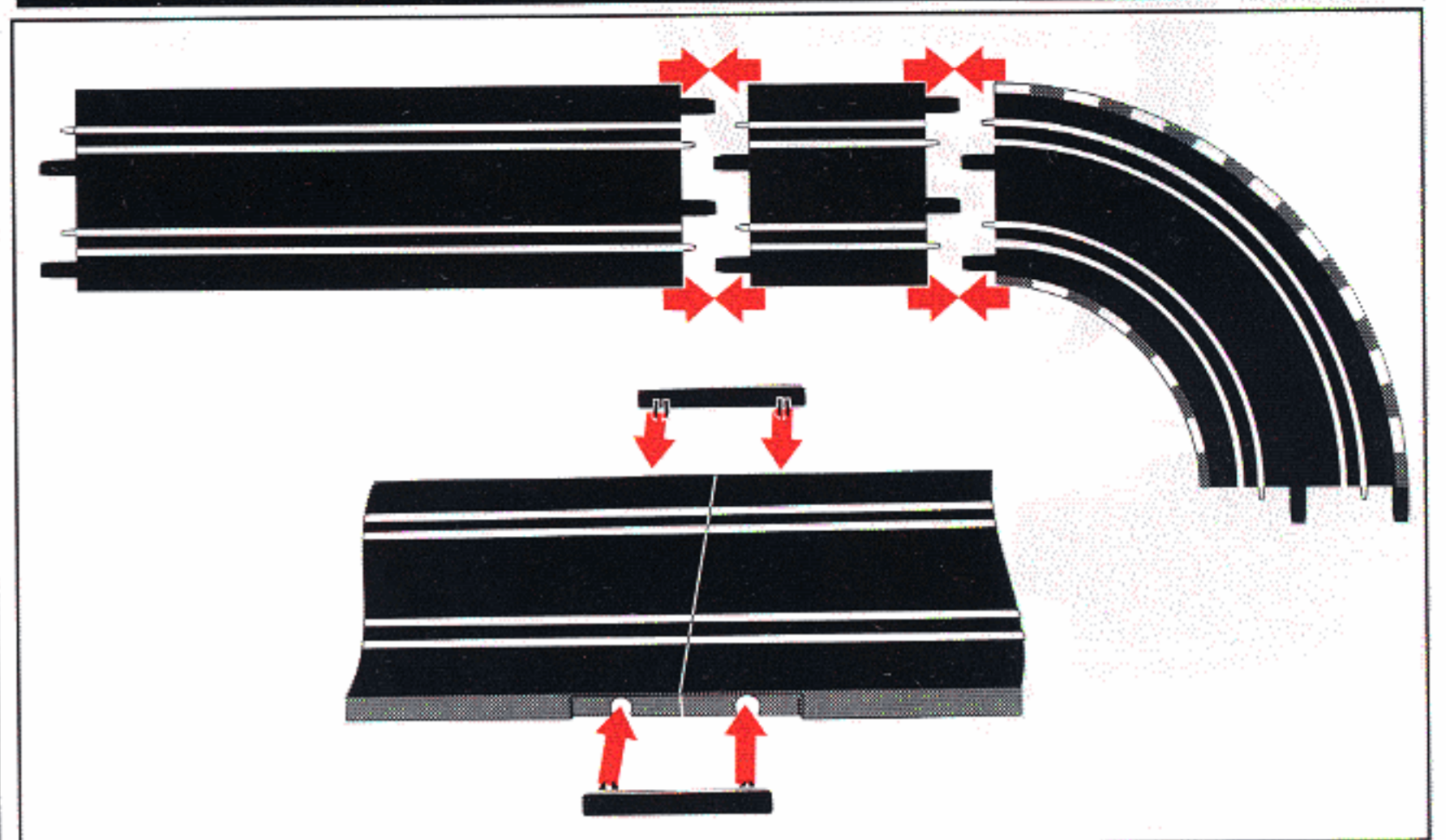

14,8V --- 2 x 350 mA



age 6+



WARNING:
 CHOKING HAZARD - Small parts
 Not for children under 3 years!

Ⓓ Änderungen vorbehalten USA GB The right to make technical modifications and changes is reserved E Sob reserva de alterações F Sous réserve de modifications
 Ⓖ El derecho de realizar modificaciones técnicas y cambios está reservado. I Salvo modifiche tecniche NL Veranderingen voorbehouden
 Ⓒ Med reservation för ändringar PL Zastrzegamy sobie możliwość zmian. HUN Összeszerelési és használati útmutató