

# **SWITEL**

**COMMUNICATION PRODUCTS**

**Strahlungsarmes schnurloses DECT-/GAP-Designtelefon**  
**Téléphone de style DECT/GAP sans fil, à faible rayonnement**  
**Telefono senza fili a bassa radiazione DECT-/GAP**  
**Low-radiation, cordless, design DECT/GAP telephone**

## **DF 82x**



**Bedienungsanleitung**  
**Mode d'emploi**  
**Istruzioni per l'uso**  
**Operating Instructions**

D

F

I

GB

# ***SWITEL***

Bedienungsanleitung .....	3
Mode d'emploi .....	23
Istruzioni per l'uso .....	43
Operating Instructions .....	65
Declaration of Conformity .....	88

1	Sicherheitshinweise .....	4
2	Telefon in Betrieb nehmen .....	5
3	Bedienelemente .....	7
4	Einführende Informationen .....	8
5	Telefonieren .....	10
6	Telefonbuch / Anrufliste .....	12
7	Nebenstellenanlagen / Zusatzdienste ..	14
8	Menüstruktur .....	15
9	Besondere Funktionen .....	17
10	Erweitern des Telefonsystems .....	18
11	Falls es Probleme gibt .....	19
12	Technische Eigenschaften .....	20
13	Pflegehinweise / Garantie .....	21
14	Stichwortverzeichnis .....	22

# Sicherheitshinweise

## 1 Sicherheitshinweise

Lesen Sie diese Bedienungsanleitung sorgfältig durch.

### Bestimmungsgemäße Verwendung

Dieses Telefon ist geeignet zum Telefonieren innerhalb eines Telefonnetzes. Jede andere Verwendung gilt als nicht bestimmungsgemäß. Eigenmächtige Veränderungen oder Umbauten sind nicht zulässig. Öffnen Sie das Gerät in keinem Fall selbst und führen Sie keine eigenen Reparaturversuche durch.

### Aufstellungsort

Vermeiden Sie Belastungen durch Rauch, Staub, Erschütterungen, Chemikalien, Feuchtigkeit, Hitze oder direkte Sonneneinstrahlung.

Verwenden Sie das Mobilteil nicht in explosionsgefährdeten Bereichen.

### Netzteil



**Achtung:** Verwenden Sie nur das mitgelieferte Steckernetzteil, da andere Netzteile das Telefon beschädigen können. Sie dürfen den Zugang zum Steckernetzteil nicht durch Möbel oder andere Gegenstände versperren.

### Aufladbare Akkus



**Achtung:** Werfen Sie Akkus nicht ins Feuer. Verwenden Sie nur Akkus des gleichen Typs! Achten Sie auf die richtige Polung! Bei verkehrter Polung der Akkus besteht beim Aufladen Explosionsgefahr.

### Stromausfall

Bei Stromausfall kann mit dem Telefon nicht telefoniert werden. Halten Sie für Notfälle ein schnurgebundenes Telefon bereit, welches ohne externe Stromversorgung arbeitet.

D

### Medizinische Geräte



**Achtung:** Benutzen Sie das Telefon nicht in der Nähe von medizinischen Geräten. Eine Beeinflussung kann nicht völlig ausgeschlossen werden.

DECT<sup>1</sup>-Telefone können in Hörgeräten einen unangenehmen Brummtönen verursachen.

## Entsorgung

Wollen Sie Ihr Gerät entsorgen, bringen Sie es zur Sammelstelle Ihres kommunalen Entsorgungsträgers (z. B. Wertstoffhof). Das nebenstehende Symbol bedeutet, dass Sie das Gerät auf keinen Fall in den Hausmüll werfen dürfen! Nach dem Elektro- und Elektronikgerätegesetz sind Besitzer von Altgeräten gesetzlich gehalten, alte **Elektro- und Elektronikgeräte** einer getrennten Abfallerfassung zuzuführen.



**Akkus** entsorgen Sie beim batterievertreibenden Handel sowie bei zuständigen Sammelstellen, die entsprechende Behälter bereitstellen.



**Verpackungsmaterialien** entsorgen Sie entsprechend den lokalen Vorschriften.

<sup>1</sup> **DECT:** Digital Enhanced Cordless Telecommunication = Standard für kabellose Telefone.

## 2 Telefon in Betrieb nehmen

### Sicherheitshinweise



**Achtung:** Lesen Sie vor der Inbetriebnahme unbedingt die Sicherheitshinweise in Kapitel 1.

### Verpackungsinhalt prüfen

Zum Lieferumfang gehören:

Inhalt	DF 82x-Modell			
	821	822 <sup>1</sup>	823 <sup>1</sup>	824 <sup>1</sup>
Basisstation mit Netzteil	1	1	1	1
Ladestation mit Netzteil	-	1	2	3
Mobilteil	1	2	3	4
Telefonanschlusskabel	1	1	1	1
Akkus	2	4	6	8
Bedienungsanleitung	1	1	1	1

<sup>1</sup> Unter [www.switel.com](http://www.switel.com) erfahren Sie, ob dieses Telefon-Set bereits erhältlich ist.

### Basisstation anschließen



**Achtung:** Stellen Sie die Basisstation mit einem Mindestabstand von 1 m zu anderen elektronischen Geräten auf, da es sonst zu gegenseitigen Störungen kommen kann.

Schließen Sie die Basisstation wie auf der Skizze abgebildet an. Verwenden Sie aus Sicherheitsgründen nur das mitgelieferte Netzteil sowie das beigelegte Telefonanschlusskabel.

Telefonanschlussdose

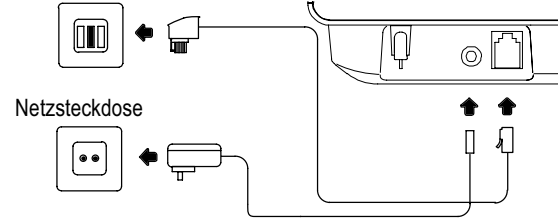

**Achtung:** Verwenden Sie für die Basisstation das Netzteil Modell Nr. SY-06030-GS, Ausgangsdaten: 6 V<sub>DC</sub>, 300 mA.

### Ladestation anschließen<sup>2</sup>

Schließen Sie die Ladestation wie auf der Skizze abgebildet an. Verwenden Sie aus Sicherheitsgründen nur das mitgelieferte Netzteil.

Netzsteckdose

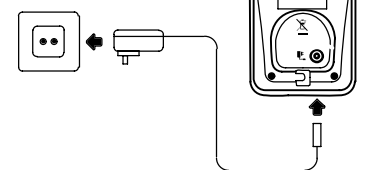

**Achtung:** Verwenden Sie für die Ladestation das Netzteil Modell Nr. SY-06020-GS, Ausgangsdaten: 6 V<sub>DC</sub>, 200 mA.

<sup>2</sup> Gilt nur für Telefonsets mit mindestens zwei Mobilteilen  
 "Verpackungsinhalt prüfen" auf Seite 5.

# Telefon in Betrieb nehmen

## Akkus einlegen

Öffnen Sie das Akkufach. Legen Sie die Akkus in das Akkufach ein. Verwenden Sie nur die mitgelieferten Akkus. Schließen Sie das Akkufach.

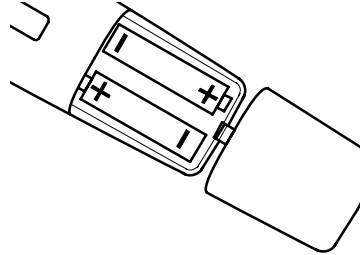

## Akkus aufladen



Stellen Sie das Mobilteil bei der ersten Inbetriebnahme für **mindestens 14 Stunden** in die Basisstation / Ladestation.

Das Mobilteil erwärmt sich beim Laden. Dies ist normal und ungefährlich. Laden Sie das Mobilteil nicht mit fremden Aufladegeräten. Der aktuelle **Akkuladezustand** wird im Display angezeigt:



Voll



Halb



Schwach



Leer

## Datum und Uhrzeit des Mobilteils einstellen

Datum und Uhrzeit stellen Sie über das Menü ein. Auf Seite 15 finden Sie die Position im Menü.

## Displaysprache einstellen

Die Displaysprache ist in Deutsch, Englisch, Italienisch und Französisch vorhanden. Sie können die Sprache über das Menü einstellen. Auf Seite 16 finden Sie die Position im Menü.

D

## Automatische Anrufannahme

Haben Sie die Funktion aktiviert, wird ein Anruf automatisch beim Herausnehmen des Mobilteils aus der Basisstation angenommen. Die automatische Anrufannahme wird über das Menü aktiviert oder deaktiviert. Auf Seite 16 finden Sie die Position "Direktannahme" im Menü.

## Strahlungsreduzierung (ECO-Mode)













Im Gesprächsmodus wird die Strahlung des Handteils im Vergleich zu Standard-DECT-Schnurlostelefonen erheblich reduziert.

## 3 Bedienelemente

Die Tasten Ihres Telefons werden in dieser Bedienungsanleitung nachfolgend mit vereinheitlichten umrandeten Symbolen dargestellt. Leichte Abweichungen der Tastensymbole Ihres Telefons gegenüber den hier verwendeten Tastensymbolen sind daher möglich.

### Mobilteil

- 1 Hörer
- 2 Display
- 3 INT-Taste 
- 4 Softkey-Taste rechts
- 5 Freisprechen 
- 6 Aufwärts 
- 7 Rechts  / Anrufliste 
- 8 Auflegen-Taste  
Bereitschaftsmodus 
- 9 Zifferntastenblock
- 10 #-Taste / Tonruf ausschalten
- 11 Mikrofon
- 12 \*-Taste / Tastensperre /  
Temporäre Tonwahl
- 13 Gesprächstaste 
- 14 Abwärts  /  
Wahlwiederholung 
- 15 Links 
- 16 R-Taste (Flash) 
- 17 Softkey-Taste links
- 18 Lautsprecher  
(auf der Rückseite)

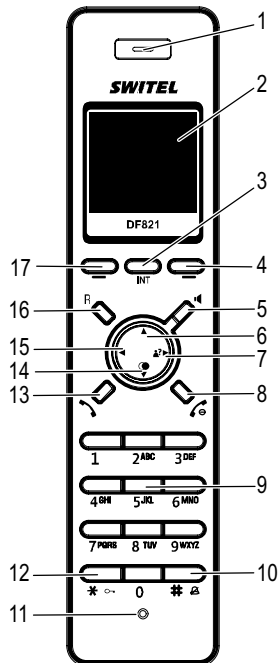

### Basisstation

- 1 Ladkontakte
- 2 Mobilteil suchen  
(Paging) 

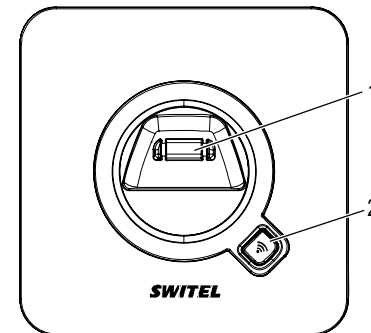















# Einführende Informationen















## 4 Einführende Informationen

In diesem Kapitel finden Sie grundlegende Informationen zur Handhabung der Bedienungsanleitung und des Telefons.

### Darstellungsweise in der Bedienungsanleitung

Darstellung	Beschreibung
	Darstellung von Tasten
	Abgebildete Taste kurz drücken
2 Sek. 	Abgebildete Taste 2 Sekunden drücken
halten 	Abgebildete Taste halten
loslassen 	Abgebildete Taste loslassen
	Nummern oder Buchstaben eingeben
	Mobilteil klingelt
	Basisstation klingelt
	Mobilteil aus der Basisstation nehmen
	Mobilteil in die Basisstation stellen
	Darstellung von Display-Texten
	Darstellung von Display-Symbolen
	Softkey-Taste drücken  Seite 7

### Symbole und Texte im Display des Mobilteils

Symbol	Beschreibung
	Konstant: Anzeige der Batteriekapazität. Durchlaufende Segmente: Die Akkus werden geladen  Seite 6.
	Konstant: Alarmfunktion aktiviert. Blinkend: Alarm.
tt/mm hh:mm	Anzeige des Datums und der Uhrzeit  Seite 15.
	Konstant: Sie führen ein Gespräch. Neue Einträge in der Anrufliste. Blinkend: Es erreicht Sie ein Anruf  Seite 10.
	Ihr Anrufbeantworter im Telefonnetz hat neue Nachrichten (VMWI <sup>1</sup> ). Zusatzdienst Ihres Netzbetreibers  Seite 14.
	Der Tonruf ist ausgeschaltet  Seite 11.
	Das Freisprechen ist aktiviert  Seite 11.
	Die Tastensperre ist aktiviert  Seite 11.
	Konstant: Sie führen ein internes Gespräch. Blinkend: Es erreicht Sie ein interner Anruf.
	Konstant: Die Verbindung zur Basisstation ist gut.
	Blinkend: Die Verbindung zur Basisstation bricht ab. Nähern Sie sich der Basisstation.

<sup>1</sup> VMWI: Visual Message Waiting Indication = Optische Anzeige neuer Nachrichten.



## Bereitschaftsmodus

Alle Beschreibungen in dieser Bedienungsanleitung gehen davon aus, dass sich das Mobilteil im Bereitschaftsmodus befindet. Den Bereitschaftsmodus erreichen Sie, indem Sie die Taste  drücken.

## Energiesparmodus

Nach einiger Zeit im Bereitschaftsmodus wechselt das Mobilteil in einen Energiesparmodus. Das Display ist nun nicht mehr beleuchtet. Drücken Sie eine beliebige Taste, um den Bereitschaftsmodus zu aktivieren.

## Navigationstasten



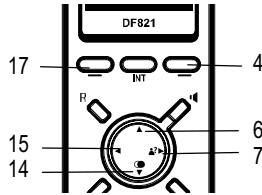

Die Softkey-Tasten (4 und 17) sind in den verschiedenen Menüs mit unterschiedlichen Funktionen belegt. Sie sind in dieser Bedienungsanleitung immer nach den darüber liegenden Texten im Display benannt.



Taste	Im Bereitschaftsmodus	Im Menü
4	- Telefonbuch öffnen	- Eine Ebene zurück
6		- In den Menüs blättern - Einstellungen ändern
7	- Anrufliste öffnen	- Einstellungen ändern
14	- Wahlwiederholungsliste öffnen	- In den Menüs blättern - Einstellungen ändern
15		- Einstellungen ändern
17	- Hauptmenü öffnen	- Angezeigtes Menü öffnen

## Navigation im Menü









Alle Funktionen sind über unterschiedliche Menüs zu erreichen. Den Weg zur gewünschten Funktion entnehmen Sie der Menüstruktur  Seite 15.

<b>Menü</b>	Hauptmenü öffnen
	Gewünschtes Untermenü auswählen
<b>Wähle</b>	Untermenü öffnen
	Gewünschte Funktion auswählen
<b>Wähle</b>	Funktion öffnen
	Gewünschte Einstellung auswählen
	Über Tastenfeld Nummern oder Buchstaben eingeben
<b>Wähle</b>	Eingaben bestätigen
<b>Zurück</b>	Eine Ebene zurück
	Programmier-/Speichervorgänge abbrechen, Bereitschaftsmodus

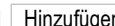
 Jeder Vorgang wird automatisch abgebrochen, wenn innerhalb von 30 Sekunden keine Eingabe erfolgt.

## Telefonbucheinträge erstellen - Beispiel

Verfahren Sie bei allen Einstellungen wie in diesem Beispiel.

<b>Menü</b>	Menü öffnen
 /  , <b>Telefonbuch</b> , <b>Wähle</b>	Telefonbuch auswählen und bestätigen
 /  , <b>Hinzufügen</b> , <b>Wähle</b>	Funktion auswählen und bestätigen
 	Namen eingeben und weiter
 	Rufnummer eingeben und weiter
 /  , <b>Ok</b>	Melodie auswählen und bestätigen

 #-Taste 2 Sekunden gedrückt halten, um zwischen Groß- und Kleinschreibung umzuschalten.

# Telefonieren

## 5 Telefonieren

### Anruf annehmen

,  oder  Anruf annehmen

### Gespräch beenden

 oder  Gespräch beenden

### Mobilteil aus- und einschalten

Um die Akkus zu schonen, können Sie das Mobilteil ausschalten.

3 Sek.  Mobilteil ausschalten



2 Sek.  Mobilteil einschalten

### Anrufen

 Rufnummer eingeben (max. 24 Ziffern)

**Lösche** Bei Falscheingabe letzte Ziffer löschen



 Rufnummer wählen

 Sie können auch zuerst die Gesprächstaste /Freisprech-Taste  drücken und erhalten damit das Freizeichen. Die eingegebenen Ziffern Ihrer gewünschten Rufnummer werden sofort gewählt. Eine Korrektur einzelner Ziffern der Rufnummer ist bei dieser Form des Gesprächsaufbaus nicht möglich.

### Wahlwiederholung

Ihr Telefon speichert die 20 zuletzt gewählten Rufnummern in einer Wahlwiederholungsliste. Weitere Informationen  Seite 13.

 Wahlwiederholungsliste öffnen



 oder ,  Eintrag auswählen und Verbindung herstellen

### Eingegangene Anrufe zurückrufen

Ihr Telefon speichert 30 Anrufe in einer Anrufliste  Seite 12.

Neue Anrufe sind mit einem \* versehen.



 Anrufliste öffnen

 oder ,  Eintrag auswählen und Verbindung herstellen

### Rufnummern aus dem Telefonbuch wählen

Sie müssen Rufnummern im Telefonbuch gespeichert haben  Seite 9 und 12.

**TB** Telefonbuch öffnen

 oder ,  Eintrag auswählen und Verbindung herstellen

### Intern telefonieren<sup>1</sup>

#### Interne Gespräche führen



Sie müssen zwei oder mehr Mobilteile (MT1, MT2, ...) an Ihrer Basisstation angemeldet haben, um interne kostenlose Gespräche führen zu können.

MT1: **INT**,  
 oder , **Wähle** Interne Rufnummer des gewünschten Mobilteils wählen

MT2:  Internes Gespräch am anderen Mobilteil annehmen

MT1 / MT2:  Internes Gespräch beenden

#### Externe Gespräche intern weiterleiten

MT1: **INT**,  
 oder , **Wähle** Während des externen Gesprächs interne Rufnummer wählen

MT2:  Internes Gespräch am anderen Mobilteil annehmen

MT1:  Gespräch weiterleiten

<sup>1</sup> Das interne Telefonieren ist nur mit mindestens zwei Mobilteilen möglich  "Verpackungsinhalt prüfen" auf Seite 5.

## Rücksprache / Makeln

Während eines externen Gesprächs können Sie ein anderes Mobilteil auswählen, um Rücksprache zu halten. Der externe Gesprächspartner wird gehalten, während Sie mit dem internen Gesprächspartner sprechen. Diesen Vorgang können Sie beliebig oft wiederholen.



MT1: **INT**,  
 oder , **Wähle** Während des externen Gesprächs interne Rufnummer wählen

MT2:  Internes Gespräch am anderen Mobilteil annehmen

MT1: **INT** Gesprächspartner wechseln

## Konferenzgespräche führen

Ein externes Gespräch kann mit einem weiteren internen Gesprächspartner zum Konferenzgespräch geschaltet werden.

MT1: **INT**,  
 oder , **Wähle** Während des externen Gesprächs interne Rufnummer wählen

MT2:  Internes Gespräch am anderen Mobilteil annehmen

MT1: halten **INT** Konferenz starten

MT1: **INT** Nur externes Gespräch weiterführen

MT1 / MT2:  Konferenz beenden

## Einstellen der Hörerlautstärke

Sie können während eines Gesprächs die Lautstärke in 5 Stufen anpassen.

 oder  Gewünschte Lautstärke auswählen

## Anzeige der Gesprächsdauer

Während eines Gesprächs wird die Gesprächsdauer in Stunden, Minuten und Sekunden angezeigt.

## Freisprechen

Nutzen Sie diese Funktion, um den Gesprächspartner über den Lautsprecher zu hören.

 Freisprechen einschalten

 Freisprechen ausschalten

## Mikrofon im Mobilteil stummschalten

Sie können während eines Telefongesprächs das Mikrofon des Mobilteils aus- und einschalten.

**Mute** Mikrofon ausschalten (stummschalten)

**Unmute** Mikrofon einschalten

## Tastensperre

Die Tastensperre verhindert, dass versehentlich Tasten gedrückt werden.

2 Sek.  Tastensperre einschalten

 Bei eingeschalteter Tastensperre können eingehende Anrufe wie gewohnt angenommen werden.

2 Sek.  Tastensperre ausschalten

## Tonrufmelodie des Mobilteils

Sie können die Tonrufmelodie am Mobilteil ausschalten.

2 Sek.  Tonrufmelodie ausschalten

2 Sek.  Tonrufmelodie einschalten

## Mobilteil suchen (Paging)

Wenn Sie Ihr Mobilteil verlegt haben, können Sie es über einen Suchton leicht wiederfinden.

an der Basis   Suchton starten

 oder  oder **Ok** Suchton beenden

# Telefonbuch / Anrufliste

## 6 Telefonbuch / Anrufliste

### Telefonbuch

Im Telefonbuch können Sie 100 Rufnummern mit den dazugehörigen Namen speichern.

Namen können maximal 12 Stellen, Rufnummern 24 Ziffern lang sein.

- Geben Sie bei allen Rufnummern immer die Vorwahl mit ein, damit auch eingehende Ortsgespräche einem Telefonbucheintrag zugeordnet werden können.
- Ist die Speicherkapazität erschöpft, zeigt das Display beim nächsten Speichern die Meldung "Speicher voll". Um wieder Platz zu schaffen, müssen Sie zuerst einen anderen Eintrag löschen.
- Die Telefonbucheinträge sind alphabetisch geordnet. Um direkt zum gewünschten Telefonbucheintrag zu gelangen, drücken Sie den entsprechenden Anfangsbuchstaben.

### Namen eingeben

Die Ziffern-Tasten sind mit Buchstaben beschriftet. Durch mehrmaliges Drücken der entsprechenden Taste können Buchstaben und Ziffern eingegeben werden.

	Leerzeichen eingeben
	Ein Zeichen löschen
halten 	Alle Zeichen löschen



Um den gleichen Buchstaben zweimal einzugeben, drücken Sie den entsprechenden Buchstaben. Warten Sie, bis der Cursor eine Stelle weitergesprungen ist. Geben Sie den Buchstaben erneut ein.

### Anrufliste

Insgesamt werden 30 Rufnummern in einer Anrufliste gespeichert.



Die Rufnummernanzeige (**CLIP**<sup>1</sup>) ist ein Zusatzdienst Ihres Netzbetreibers. Ihr Telefon zeigt die Rufnummern im Display, wenn Ihr Netzbetreiber diesen Service anbietet. Bitte fragen Sie Ihren Netzbetreiber nach weiteren Informationen.

### Rufnummern aus der Anrufliste anzeigen

 Wähle Anrufliste öffnen und Eintrag auswählen

### Rufnummern aus der Anrufliste im Telefonbuch speichern

Eine Rufnummer kann direkt aus der Anrufliste im Telefonbuch gespeichert werden.

 Wähle Anrufliste öffnen und Eintrag auswählen

  / 

 Wähle Speichervorgang starten

 Namen eingeben und weiter

 ggf. Nummer bearbeiten und weiter

 Ok Melodie auswählen und bestätigen







Sobald die Rufnummer im Telefonbuch mit einem Namen gespeichert wurde, erscheint in der Anrufliste der eingegebene Name.



<sup>1</sup> **CLIP**: Calling Line Identification Presentation = Anzeige der Rufnummer eines Anrufers.

## Rufnummern aus der Anrufliste löschen

### Einzelne Rufnummer löschen

 ,  /  , Wähle	Anrufliste öffnen und Eintrag auswählen
Menü ,  / 	
Löschen , Wähle	Löschvorgang aktivieren
Ok oder Zurück	Löschvorgang bestätigen oder abbrechen



### Alle Rufnummern löschen

 , Wähle	Anrufliste öffnen
Menü ,  / 	
Alle löschen , Wähle	Löschvorgang aktivieren
Ok oder Zurück	Löschvorgang bestätigen oder abbrechen

## Wahlwiederholungsliste











Insgesamt werden 20 Rufnummern in einer Wahlwiederholungsliste gespeichert.

### Rufnummern aus der Wahlwiederholungsliste anzeigen

 ,  /  , Wähle	Wahlwiederholungsliste öffnen und Eintrag auswählen
---	---





### Rufnummern aus der Wahlwiederholungsliste speichern

Eine Rufnummer kann direkt aus der Wahlwiederholungsliste im Telefonbuch gespeichert werden.



 ,  /  , Wähle	Wahlwiederholungsliste öffnen und Eintrag auswählen
Menü ,  / 	
In TB speichern , Wähle	Speichervorgang starten
 , 	Namen eingeben und weiter
 , 	ggf. Nummer bearbeiten und weiter
 /  , Ok	Melodie auswählen und bestätigen

## Rufnummern aus der Wahlwiederholungsliste löschen

### Einzelne Rufnummer löschen

 ,  /  , Wähle	Wahlwiederholungsliste öffnen und Eintrag auswählen
Menü ,  / 	
Löschen , Wähle	Löschvorgang aktivieren
Ok oder Zurück	Löschvorgang bestätigen oder abbrechen

### Alle Rufnummern löschen

 , Wähle	Wahlwiederholungsliste öffnen
Menü ,  / 	
Alle löschen , Wähle	Löschvorgang aktivieren
Ok oder Zurück	Löschvorgang bestätigen oder abbrechen

# Nebenstellenanlagen/ Zusatzdienste

## 7 Nebenstellenanlagen / Zusatzdienste

### R-Taste an Nebenstellenanlagen

Ist Ihr Telefon an einer Nebenstellenanlage angeschlossen, können Sie über die **R-Taste** Funktionen, wie z. B. Anrufe weiterleiten und automatischen Rückruf, nutzen. Lesen Sie bitte in der Bedienungsanleitung Ihrer Nebenstellenanlage, welche Flash-Zeit Sie zur Nutzung dieser Funktionen einstellen müssen. Ob Ihr Telefon an Ihrer Nebenstellenanlage einwandfrei funktioniert, erfahren Sie bei dem Händler, bei dem die Anlage gekauft wurde. Die Flash-Zeit stellen Sie über das Menü ein. Auf Seite 16 finden Sie die Position im Menü.

### Wahlpause manuell eingeben

Sie können nach der Amtskennziffer **manuell** eine **Wahlpause** einfügen, um direkt weiterwählen zu können, ohne das Freizeichen abzuwarten.

2 Sek.  Wahlpause einfügen

Nach der Amtskennziffer erfolgt die Wahl der eigentlichen Rufnummer nach einer bestimmten Zeit.

 Die Wahlpause kann auch bei der Eingabe von Rufnummern im Telefonbuch gespeichert werden.

### R-Taste und Zusatzdienste

Ihr Telefon unterstützt Zusatzdienste Ihres Netzbetreibers, wie z. B. Makeln, Anklopfen und Konferenz. Über die **R-Taste** können Sie diese Zusatzdienste nutzen. Bitte fragen Sie Ihren Netzbetreiber, welche Flash-Zeit Sie zur Nutzung von Zusatzdiensten einstellen müssen. Zur Freischaltung von Zusatzdiensten wenden Sie sich bitte an Ihren Netzbetreiber. Die Flash-Zeit stellen Sie über das Menü ein. Auf Seite 16 finden Sie die Position im Menü.

### Rufnummernanzeige (CLIP<sup>1</sup>)



Die Rufnummernanzeige ist ein Zusatzdienst Ihres Netzbetreibers. Fragen Sie Ihren Netzbetreiber nach weiteren Informationen.

Wenn diese Funktion an Ihrer Telefonleitung zur Verfügung steht, wird Ihnen bereits die Rufnummer des Anrufers angezeigt, wenn das Telefon klingelt. Hat der Anrufer das Übertragen seiner Rufnummer unterdrückt, wird eine entsprechende Meldung angezeigt. Die Rufnummer kann nicht angezeigt und somit auch nicht in der Anrufliste gespeichert werden.

### Anrufbeantworter im Telefonnetz

Der Anrufbeantworter im Telefonnetz ist ein Zusatzdienst vieler Netzbetreiber. Wenn Ihr Netzbetreiber einen Anrufbeantworter im Telefonnetz für Sie bereitstellt, werden Sie mit einem Symbol über neue Nachrichten informiert (**VMWI**<sup>2</sup>). Über diese Funktion können Sie nur dann verfügen, wenn Ihr Netzbetreiber diesen Zusatzdienst anbietet. Bitte fragen Sie Ihren Netzbetreiber nach weiteren Informationen.

<sup>1</sup> **CLIP**: Calling Line Identification Presentation = Anzeige der Rufnummer eines Anrufers.

<sup>2</sup> **VMWI**: Visual Message Waiting Indication = Optische Anzeige neuer Nachrichten.

## 8 Menüstruktur

### Hauptmenü

In das Hauptmenü gelangen Sie durch Drücken der Softkey-Taste **Menü**. Wie Sie sich im Menü bewegen und Eingaben vornehmen, zeigt Ihnen Seite 9.

#### Anrufliste

Eintrag wählen	<b>Menü</b>	In TB speichern	Name:
			Nummer
			Melodie Mel 1-15
		Löschen	Ok/Zurück
		Alle löschen	Ok/Zurück

#### Telefonbuch

Lesen	Eintrag wählen	<b>Menü</b>	Bearbeiten
			Löschen
Hinzufügen	Name:		
	Nummer		
	Melodie Mel 1-15		
Bearbeiten	Name:		
	Nummer		
	Melodie Mel 1-15		
Löschen	Eintrag wählen	Ok/Zurück	
Alle löschen	Ok/Zurück		
Telbuch-Status			
Telb. kopieren	Mobilteil 1-6		

### Uhrzeit/Alarm

Datum/Zeit	Datumsformat	TT-MM-JJJJ
		MM-TT-JJJJ
	Zeitformat	12 Stunden
		24 Stunden
	Datum eingeben	
	Zeit eingeben  (▲) / (▼) AM/PM	
Alarm	Alarm aus	
	Alarm ein  (▲) / (▼) AM/PM	
	Alarm Melodie	Melodie 1
		Melodie 2
		Melodie 3

# Menüstruktur

## MT einstellen

Audioeinstellung	FS-Lautstärke	1-5
	Hörerlautstärke	1-5
Tonrufeinstellung	Melodie intern	Melodie 1-15
	Melodie extern	Melodie 1-15
	Tonruflautstärke	Aus, 1-5
Rufton einstell.	Tastenton	Aus/Ein
	Akku leer	Aus/Ein
	Reichweite	Aus/Ein
Sprache	Deutsch	
	Français	
	Italiano	
	English	
MT-Namen ändern		
Kontrast	Level 1-5	
Direktannahme	Aus/Ein	
Rufnummernsperr	PIN:	Sperr-Modus Aus/Ein
		Sperrnummer Nummer 1-4
SOS-Nummer	PIN:	Nummer1
		Nummer2
		Nummer3
Basisauswahl	Basis 1-4	
MT rücksetzen	PIN:	Ok/Zurück

## Basis einstellen

MT löschen	PIN:	Mobilteil 1-6
Wahlverfahren	Tonwahl/Pulswahl	
Flash-Zeit	Kurz/Mittel/Lang	
PIN ändern	PIN alt:	
	PIN neu:	
	Best.:	
Erster Ruf	Aus/Ein	
Basis rücksetzen	PIN:	Ok/Zurück

## MT anmelden

Basis 1	PIN:
Basis 2	PIN:
Basis 3	PIN:
Basis 4	PIN:



## 9 Besondere Funktionen

### Wahlverfahren

Sie können Ihr Telefon sowohl an den analogen Vermittlungsstellen (Impuls-Wahlverfahren) als auch an den neuen digitalen Vermittlungsstellen (Ton-Wahlverfahren) betreiben. Das Wahlverfahren wird über das Menü eingestellt. Auf Seite 16 finden Sie die Position im Menü.

### Temporäre Tonwahl

Können Sie Ihr Telefon nur mit dem Impuls-Wahlverfahren betreiben, brauchen Sie nicht auf die Vorteile des Ton-Wahlverfahrens (z. B.: Abfrage eines Anrufbeantworters im Telefonnetz) zu verzichten. Während einer bestehenden Verbindung können Sie vorübergehend zum Ton-Wahlverfahren wechseln.



Während des Gesprächs drücken

Nach Gesprächsende wird wieder automatisch auf das Impuls-Wahlverfahren zurückgeschaltet.

### Alarm

Mit dieser Funktion können Sie sich zu einer bestimmten Zeit von Ihrem Mobilteil alarmieren lassen. Auf Seite 15 finden Sie die Position im Menü.

### Rufnummernsperre

Die Rufnummernsperre hindert Mobilteile daran, von Ihnen hinterlegte Rufnummern zu wählen. Sie können 4 Spernummern, die aus jeweils 4 Ziffern bestehen können, hinterlegen. Auf Seite 16 finden Sie die Position im Menü.

### SOS-Nummern

Sie können bis zu 3 Rufnummern hinterlegen, die trotz aktivierter Rufnummernsperre gewählt werden können. Auf Seite 16 finden Sie die Position im Menü.

### Beispiel

Als Spernummer ist "017" eingestellt. Alle Rufnummern die mit "017" beginnen, sind gesperrt (0170 - 0179). Als SOS-Nummer ist "0173" hinterlegt. Somit ist es möglich, trotz aktiver Rufnummernsperre, Nummern zu wählen, die mit "0173" beginnen.

### Erstes Klingeln

Stellen Sie diese Funktion auf "Aus", werden die CLIP-Daten bei eingehenden Anrufen mit dem ersten, für Sie hörbaren Klingeln angezeigt. Auf Seite 16 finden Sie die Position "Erster Ruf" im Menü.

### Telefonbuch kopieren

Sie können das Telefonbuch von einem Mobilteil auf ein anderes kopieren. Diese Funktion steht nur zur Verfügung, wenn mehrere Mobilteile an der Basis angemeldet sind.

Menü	Menü öffnen
▲ / ▼, Telefonbuch	Telefonbuch auswählen, bestätigen
▲ / ▼, Telb. kopieren	Telb. kopieren auswählen, bestätigen
▲ / ▼, Wähle	Mobilteil auswählen und bestätigen
Ok / Lösche	Am Empfänger-Mobilteil bestätigen oder abbrechen

# Erweitern des Telefonsystems

## 10 Erweitern des Telefonsystems

Über den international genormten **GAP**<sup>1</sup> -Standard ist die Kompatibilität von Mobilteilen und Basisstationen unterschiedlicher Hersteller geregelt. So ist es möglich, SWITEL-Geräte und Geräte anderer Hersteller zusammen in ein Telefonsystem zu integrieren. Es ist jedoch möglich, dass einige Funktionen nicht zur Verfügung stehen.

### Mehrere Mobilteile

Sie können insgesamt 6 Mobilteile an Ihre Basisstation anmelden.

#### Anmelden von Mobilteilen

Bevor Sie ein Mobilteil anmelden, müssen Sie die Basisstation in den Registriermodus setzen.

halten  Registriermodus gestartet

Melden Sie nun das Mobilteil an  Seite 16. Benutzen Sie zur Anmeldung den aktuell eingestellten PIN-Code  Seite 16.

Nach dem Anmelden wird dem Mobilteil eine interne Rufnummer zugeordnet. Diese interne Rufnummer wird im Display angezeigt.

 Um Mobilteile anderer Hersteller anzumelden, lesen Sie bitte deren Bedienungsanleitungen.

#### Abmelden von Mobilteilen

 Sie können ein Mobilteil von einer Basisstation nur durch ein weiteres an dieser Basisstation angemeldetes Mobilteil abmelden.

Mobilteile werden über das Menü abgemeldet. Auf Seite 16 finden Sie die Position im Menü.

### Mehrere Basisstationen

Sie können die Reichweite Ihres Mobilteils vergrößern, wenn Sie es an mehrere Basisstationen anmelden. Es kann gleichzeitig an 4 verschiedenen Basisstationen angemeldet sein. Jede Basisstation benötigt eine eigene Telefonsteckdose. Es können Anschlüsse mit derselben und auch mit unterschiedlichen Rufnummern sein.

Auswahl der Basis  Seite 16.

 Laufende Gespräche können nicht von einer zur anderen Basisstation übertragen werden.

<sup>1</sup> **GAP: Generic Access Profile** = Standard für das Zusammenwirken von Mobilteilen und Basisstationen unterschiedlicher Hersteller.

## 11 Falls es Probleme gibt

### Service-Hotline

Haben Sie Probleme mit Ihrem Telefon, kontrollieren Sie zuerst die folgenden Hinweise. Bei technischen Problemen können Sie sich an unsere Service-Hotline unter Tel. 0900 00 1675 innerhalb der Schweiz (Kosten Swisscom bei Drucklegung: CHF 2.00/min) wenden. Bei Garantieansprüchen wenden Sie sich an Ihren Fachhändler. Die Garantiezeit beträgt 2 Jahre.

### Fragen und Antworten

Fragen	Antworten
Keine Verbindung zur Basisstation möglich	- Prüfen Sie, ob Sie sich mit dem richtigen PIN-Code an der Basisstation angemeldet haben ☞ Seite 16.
Kein Telefongespräch möglich	- Das Telefon ist nicht korrekt angeschlossen oder gestört. Verwenden Sie nur das mitgelieferte Telefonanschlusskabel. - Testen Sie mit einem anderen Telefon, ob Ihr Telefonanschluss in Ordnung ist. - Das Netzteil ist nicht eingesteckt oder es liegt ein totaler Stromausfall vor. - Die Akkus sind leer oder defekt. - Sie haben sich zu weit von der Basisstation entfernt. - Wahlverfahren falsch eingestellt ☞ Seite 16.
Verbindung abgehackt, fällt aus	- Sie haben sich zu weit von der Basisstation entfernt. - Falscher Aufstellungsort der Basisstation.

Das System reagiert nicht mehr

- Setzen Sie alle Funktionen in den Werkszustand zurück ☞ Seite 16.
- Ziehen Sie kurzzeitig das Netzteil aus der Steckdose.

Die Akkus sind in kürzester Zeit leer

- Die Akkus sind leer oder defekt.
- Stellen Sie das Mobilteil richtig auf die Basisstation. Reinigen Sie die Kontaktflächen am Mobilteil und an der Basisstation mit einem weichen trockenen Tuch.
- Stellen Sie das Mobilteil für 14 Stunden in die Basisstation.

Die Rufnummernanzeige (CLIP<sup>1</sup>) funktioniert nicht

- Die Rufnummernanzeige ist ein Zusatzdienst Ihres Netzbetreibers. Bitte fragen Sie Ihren Netzbetreiber nach weiteren Informationen.
- Der Anrufer hat das Übertragen seiner Rufnummer unterdrückt.



<sup>1</sup> CLIP: Calling Line Identification Presentation = Anzeige der Rufnummer eines Anrufers.

# Technische Eigenschaften

## 12 Technische Eigenschaften

### Technische Daten

Merkmal	Wert
Standard	<b>DECT<sup>1</sup>-GAP<sup>2</sup></b>
Stromversorgung (Basisstation)	Eingang: 230 V <sub>AC</sub> , 50 Hz Ausgang: 6 V <sub>DC</sub> , 300 mA
Stromversorgung (Ladestation)	Eingang: 230 V <sub>AC</sub> , 50 Hz Ausgang: 6 V <sub>DC</sub> , 200 mA
Reichweite	Außen: ca. 300 m Innen: ca. 50 m
Bereitschaft	Bis zu 100 h
Max. Gesprächsdauer	Bis zu 10 h
Aufladbare Akkus	2 x AAA NiMH 1,2 V
Wahlverfahren	Tonwahl (DTMF) Pulswahl (IWW)
Zulässige Umgebungstemperatur	10 °C bis 30 °C
Zulässige relative Luftfeuchtigkeit	20 % bis 75 %
Flash-Funktion	Kurz, Mittel, Lang

<sup>1</sup> **DECT**: Digital Enhanced Cordless Telecommunication = Standard für kabellose Telefone.

<sup>2</sup> **GAP**: Generic Access Profile = Standard für das Zusammenwirken von Mobilteilen und Basisstationen unterschiedlicher Hersteller.

### Werkseinstellungen

#### Mobilteil

Die Werkseinstellungen werden über das Menü wiederhergestellt. Auf Seite 16 finden Sie die Position im Menü.

Tonruflautstärke	Level 5	Hörerlautstärke	Level 3
Melodie extern	Melodie 2	FS-Lautstärke	Level 3
Melodie intern	Melodie 1	Kontrast	Level 3
Tastenton	Ein	Reichweite	Ein
Akku leer	Ein	Erster Ruf	Ein
Name:	DF 821	Sprache	Deutsch

#### Basisstation

Die Werkseinstellungen werden über das Menü wiederhergestellt. Auf Seite 16 finden Sie die Position im Menü.

Wahlverfahren	Tonwahl	PIN:	0000
Flash-Zeit	Kurz	Direktannahme	Ein
Tonrufmelodie	Melodie 1	Tonruflautstärke	Level 5

### Konformitätserklärung

Dieses Gerät erfüllt die Anforderungen der EU-Richtlinie: 1999/5/EG Richtlinie über Funkanlagen und Telekommunikations-einrichtungen und die gegenseitige Anerkennung ihrer Konformität. Die Konformität mit der o. a. Richtlinie wird durch das CE-Zeichen auf dem Gerät bestätigt.

Für die komplette Konformitätserklärung nutzen Sie bitte den kostenlosen Download von unserer Website [www.switel.com](http://www.switel.com).



## 13 Pflegehinweise / Garantie

### Pflegehinweise

- Reinigen Sie die Gehäuseoberflächen mit einem weichen und fusselfreien Tuch.
- Verwenden Sie keine Reinigungs- oder Lösungsmittel.

### Garantie

SWITEL - Geräte werden nach den modernsten Produktionsverfahren hergestellt und geprüft. Ausgesuchte Materialien und hoch entwickelte Technologien sorgen für einwandfreie Funktion und lange Lebensdauer. Ein Garantiefall liegt nicht vor, wenn die Ursache einer Fehlfunktion des Gerätes bei dem Telefonnetzbetreiber oder einer eventuell zwischengeschalteten Nebenstellenanlage liegt. Die Garantie gilt nicht für die in den Produkten verwendeten Batterien, Akkus oder Akkupacks. Die Garantiezeit beträgt 24 Monate, gerechnet vom Tage des Kaufs.

Innerhalb der Garantiezeit werden alle Mängel, die auf Material- oder Herstellungsfehler zurückzuführen sind, kostenlos beseitigt. Der Garantieanspruch erlischt bei Eingriffen durch den Käufer oder durch Dritte. Schäden, die durch unsachgemäße Behandlung oder Bedienung, natürliche Abnutzung, durch falsches Aufstellen oder Aufbewahren, durch unsachgemäßen Anschluss oder Installation sowie durch höhere Gewalt oder sonstige äußere Einflüsse entstehen, fallen nicht unter die Garantieleistung. Wir behalten uns vor, bei Reklamationen die defekten Teile auszubessern, zu ersetzen oder das Gerät auszutauschen. Ausgetauschte Teile oder ausgetauschte Geräte gehen in unser Eigentum über. Schadenersatzansprüche sind ausgeschlossen, soweit sie nicht auf Vorsatz oder grober Fahrlässigkeit des Herstellers beruhen.

Sollte Ihr Gerät dennoch einen Defekt innerhalb der Garantiezeit aufweisen, wenden Sie sich bitte unter Vorlage Ihrer Kaufquittung ausschließlich an das Geschäft, in dem Sie Ihr SWITEL - Gerät gekauft haben. Alle Gewährleistungsansprüche nach diesen Bestimmungen sind ausschließlich gegenüber Ihrem Fachhändler geltend zu machen. Nach Ablauf von zwei Jahren nach Kauf und Übergabe unserer Produkte können Gewährleistungsrechte nicht mehr geltend gemacht werden.

# Stichwortverzeichnis

## 14 Stichwortverzeichnis

### A

Abmelden, 18  
Abnehmen, 10  
Akkuladezustand, 6  
Akkus einlegen, 6  
Alarm, 17  
Anmelden, 18  
Anrufannahme, 6, 10  
Anrufbeantworter im Telefonnetz, 14  
Anrufen, 10  
Anrufliste, 12  
Aufladen, 6  
Auflegen, 10  
Ausschalten, 10

### B

Basisstation, 5, 18  
Bedienelemente, 7  
Bedienung, 8  
Bereitschaftsmodus, 9

### C

CLIP, 14

### D

Datum, 6  
Display, 8  
Displaysprache, 6  
Displaysymbole, 8

### E

ECO-Mode, 6  
Einschalten, 10  
Energiesparmodus, 9  
Erstellen, 9  
Erstes Klingeln, 17  
Erweiterung, 18

### F

Fehlerbehebung, 19  
Fragen und Antworten, 19  
Freisprechen, 11  
Funktionen, 17

### G

Garantie, 21  
Gespräch beenden, 10  
Gesprächsdauer, 11  
Gesprächsweiterleitung, 10

### H

Hauptmenü, 15  
Hörerlautstärke, 11

### I

Impuls-Wahlverfahren, 17  
Inbetriebnahme, 5  
Interngespräche, 10

### K

Konferenzgespräche, 11  
Konformitätserklärung, 20

### L

Ladestation, 5  
Löschen, 13

### M

Makeln, 11  
Menüstruktur, 15  
Mikrofonstummenschaltung, 11  
Mobilteil, 18

### N

Namenseingabe, 12  
Navigationstasten, 9  
Nebenstellenanlagen, 14

### P

Paging, 11  
Pflegehinweise, 21  
Probleme, 19

### R

R-Taste, 14  
Rückruf, 10  
Rücksprache, 11  
Rufnummernanzeige, 12, 14  
Rufnummernsperre, 17

### S

Schreibweisen, 8  
Service-Hotline, 19  
Sicherheitshinweise, 4  
SOS-Nummern, 17  
Speichern, 9, 12, 13  
Strahlungsreduzierung, 6  
Stummenschaltung, 11  
Suchen, 11  
Symbole, 8

### T

Tastensperre, 11  
Technische Daten, 20  
Telefonbuch, 10, 12  
Telefonbucheinträge, 9  
Telefonbucheinträge kopieren, 17  
Telefonieren, 10  
Temporäre Tonwahl, 17  
Texteingabe, 12  
Ton-Wahlverfahren, 17  
Tonrufmelodie, 11

### U

Uhrzeit, 6

### V

Verpackungsinhalt, 5  
VMWI, 14

### W

Wählen, 10  
Wahlpause manuell eingeben, 14  
Wahlverfahren, 17  
Wahlwiederholung, 10, 13  
Wahlwiederholungsliste, 13  
Weiterleitung, 10  
Werkseinstellungen, 20

### Z

Zusatzdienste, 14

1	Consignes de sécurité . . . . .	24
2	Mettre votre téléphone en service . . . . .	25
3	Éléments de manipulation . . . . .	27
4	Introduction . . . . .	28
5	Téléphoner . . . . .	30
6	Répertoire/Liste d'appels . . . . .	32
7	Installations à postes supplémentaires / Services confort . . . . .	34
8	Structure du menu . . . . .	35
9	Fonctions particulières . . . . .	37
10	Élargissement du système téléphonique	38
11	En cas de problèmes . . . . .	39
12	Caractéristiques techniques . . . . .	40
13	Remarques d'entretien / Garantie . . . . .	41
14	Index . . . . .	42

# Consignes de sécurité

## 1 Consignes de sécurité

Lisez très attentivement ce mode d'emploi.

### Utilisation conforme aux prescriptions

Ce téléphone convient pour téléphoner à l'intérieur d'un réseau téléphonique. Toute autre utilisation est considérée comme non conforme à l'usage. Des modifications ou changements effectués d'un propre gré ne sont pas autorisés. N'ouvrez en aucun cas l'appareil et n'effectuez aucun essai de réparation vous-même.

### Lieu d'installation

Évitez toute nuisance par la fumée, la poussière, les vibrations, les produits chimiques, l'humidité, la grande chaleur ou l'ensoleillement direct. Ne vous servez pas du combiné dans des endroits exposés aux explosions.

### Bloc secteur



**Attention :** N'utilisez que le bloc secteur fourni avec l'appareil, d'autres pouvant endommager votre téléphone. Vous ne devez pas bloquer son accès par des meubles ou d'autres objets.

### Piles rechargeables



**Attention :** Ne jetez pas les piles rechargeables dans le feu. N'utilisez que des piles rechargeables du même type ! Observez une polarisation correcte ! Risque d'explosion lors de leur chargement si la polarisation est incorrecte.

### Panne de courant

En cas de panne de courant, vous ne pouvez pas téléphoner avec cet appareil. Pour parer aux cas d'urgence, tenez à votre disposition un téléphone à fil fonctionnant sans alimentation externe en courant.

### Appareils médicaux



**Attention :** N'utilisez pas ce téléphone à proximité d'appareils médicaux. Leur influence ne peut être totalement exclue.

Les téléphones **DECT**<sup>1</sup> peuvent causer un bourdonnement désagréable dans les prothèses auditives.

## Élimination

Si vous ne voulez plus vous servir de votre appareil, veuillez l'apporter au centre de collecte de l'organisme d'élimination des déchets de votre commune (par ex. centre de recyclage). L'icône ci-contre signifie que vous ne devez en aucun cas jeter votre appareil dans les ordures ménagères ! D'après la loi relative aux appareils électriques et électroniques, les propriétaires d'appareils usagés sont tenus de mettre tous les **appareils électriques et électroniques** usagés dans un collecteur séparé.

**Éliminez les piles rechargeables** auprès d'un revendeur de piles ainsi que dans des centres de collecte compétents qui tiennent à votre disposition les collecteurs appropriés correspondants.

Éliminez les **fournitures d'emballage** conformément au règlement local.



<sup>1</sup> **DECT:** Digital Enhanced Cordless Telecommunication = Standard pour les téléphones sans fil.



## 2 Mettre votre téléphone en service

### Remarques concernant la sécurité



**Attention :** Avant de mettre votre appareil en service, lisez impérativement les consignes de sécurité mentionnées au chapitre 1.

### Vérifier le contenu de l'emballage

Les éléments suivants font partie de la livraison :

Contenu	Modèle DF 82x			
	821	822 <sup>1</sup>	823 <sup>1</sup>	824 <sup>1</sup>
Base avec bloc secteur	1	1	1	1
Chargeur avec bloc secteur	-	1	2	3
Combiné	1	2	3	4
Câble de raccordement téléphonique	1	1	1	1
Piles rechargeables	2	4	6	8
Mode d'emploi	1	1	1	1

<sup>1</sup> À l'adresse [www.switel.com](http://www.switel.com), vous apprendrez si ce kit téléphonique est déjà disponible à la vente.

### Raccorder la base



**Attention :** Posez la base à une distance minimum d'1 m par rapport à d'autres appareils électroniques, une distance inférieure pouvant provoquer des interactions.

Raccordez la base comme représenté sur le croquis. Pour des raisons de sécurité, n'utilisez que le bloc secteur fourni avec l'appareil ainsi que le câble de raccordement téléphonique ci-joint.

Prise de raccordement téléphonique

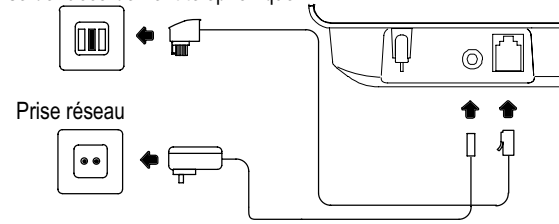

**Attention :** Pour la base, utilisez le bloc secteur modèle n° SY-06030-GS, données de sortie : 6 V<sub>DC</sub>, 300 mA.

### Raccorder le chargeur<sup>2</sup>

Raccordez le chargeur comme représenté sur le croquis. Pour des raisons de sécurité, n'utilisez que le bloc secteur fourni avec l'appareil.

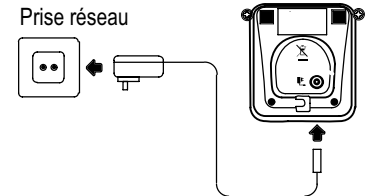

**Attention :** Pour le chargeur, utilisez le bloc secteur modèle n° SY-06020-GS, données de sortie : 6 V<sub>DC</sub>, 200 mA.

<sup>2</sup> Valable uniquement pour les installations téléphoniques équipées d'au moins deux combinés

☞ "Contenu de l'emballage" à la page 25.

## Mettre votre téléphone en service

### Poser des piles rechargeables

Ouvrez le compartiment à piles. Introduisez les piles rechargeables dans le compartiment à piles. N'utilisez que les piles rechargeables livrées avec l'appareil. Fermez le compartiment à piles.

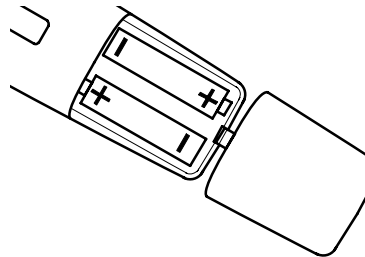

### Charger les piles rechargeables



Pour la première mise en service, mettez le combiné sur la base / le chargeur et l'y laisser pendant **au moins 14 heures**.

Le combiné chauffe lors du chargement. C'est normal et inoffensif. Ne chargez pas le combiné avec des chargeurs d'autres fabricants. Le **niveau actuel de chargement des piles** s'affiche à l'écran :



Plein



Moyen



Faible



Vide

### Régler la date et l'heure du combiné

Vous réglez la date et l'heure via le menu. La page 35 vous donnera la position dans le menu.

### Paramétrer la langue de l'écran

La langue de l'écran existe en allemand, en anglais, en italien et en français. Vous pouvez paramétrer la langue via le menu. La page 36 vous donnera la position dans le menu.

F

### Prise d'appel automatique

Si vous avez activé la fonction, l'appel sera automatiquement réceptionné quand vous prendrez le combiné de la base. La prise d'appel automatique s'active ou se désactive via le menu. À la page 36 vous trouverez la position "Réponse auto" dans le menu.

### Réduction du rayonnement (mode ÉCO)













En mode de communication, le rayonnement du combiné est considérablement réduit par rapport aux téléphones DECT sans fil standard.

## 3 Éléments de manipulation

Dans ce mode d'emploi, les touches de votre téléphone seront représentées par la suite par des icônes encadrées standardisées. C'est pourquoi de légères différences sont possibles entre les icônes des touches de votre téléphone et celles utilisées ici.

### Combiné

- 1 Écouteur
- 2 Écran
- 3 Touche INT 
- 4 Touche softkey droite
- 5 Mode mains-libres 
- 6 Vers le haut 
- 7 Vers la droite 
- Liste d'appels 
- 8 Touche pour raccrocher Mode veille 
- 9 Pavé numérique
- 10 Touche # / Désactiver la sonnerie d'appel
- 11 Microphone
- 12 Touche \* / Verrouillage du clavier / Numérotation temporaire par tonalité
- 13 Touche de communication 
- 14 Vers le bas 
 / Répétition automatique des derniers numéros - 15 Vers la gauche 
- 16 Touche R (Flash) 
- 17 Touche softkey gauche
- 18 Haut-parleur

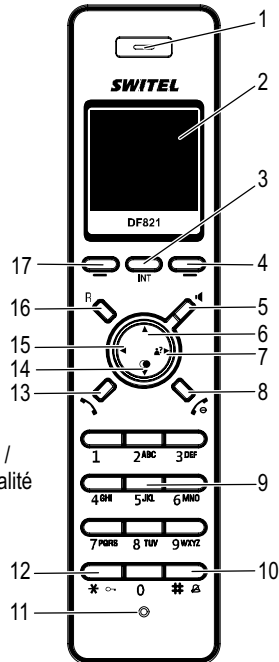

### Base

- 1 Contacts de chargement
- 2 Chercher le combiné (paging) 

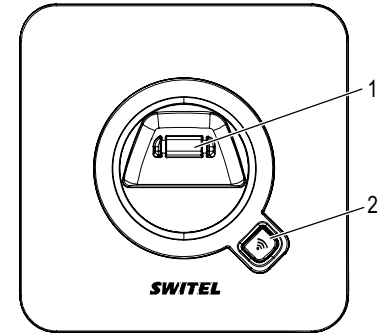

# Introduction

## 4 Introduction

Dans ce chapitre, vous trouverez des informations de base vous expliquant comment vous servir du mode d'emploi et du téléphone.

### Mode de représentation dans le mode d'emploi

Visualisation	Description
	Visualisation des touches
	Appuyer brièvement sur la touche représentée
2 sec.	Appuyer 2 secondes sur la touche représentée
Maintenir	Maintenir appuyée la touche représentée
Relâcher	Relâcher la touche représentée
	Saisir des chiffres ou des lettres
	Le combiné sonne
	La base sonne
	Prendre le combiné de la base
	Poser le combiné sur la base
	Visualisation des textes de l'écran
	Visualisation des icônes de l'écran
	Appuyer sur la touche softkey  page 27

### Icônes et textes sur l'écran du combiné

Icône	Description
	Constant: affichage de la capacité des piles. Segments continus : les piles rechargeables se rechargent  page 26.
	Constant: la fonction d'alarme est activée. Clignotant: alarme.

jj/mm hh:mm	Affichage de la date et de l'heure page 35
	Constant: vous passez une communication. Nouveaux enregistrements dans la liste d'appels. Clignotant: un appel vous parvient  page 30.
	Votre répondeur, dans le réseau téléphonique, a de nouveaux messages ( <b>VMWI</b> <sup>1</sup> ). Service confort de votre opérateur  page 34.
	La sonnerie est débranchée  page 31.
	Le mode mains-libres est activé  page 31.
	Le verrouillage du clavier est activé  page 31.
	Constant: vous passez une communication interne. Clignotant: un appel interne vous parvient.
	Constant: la liaison avec la base est bonne.
	Clignotant: la liaison avec la base est interrompue. Rapprochez-vous de la base.

### Mode veille

Toutes les descriptions dans ce mode d'emploi partent du principe que le combiné se trouve en mode veille. Vous parvenez au mode veille en appuyant sur la touche

### Mode économie d'énergie

Au bout d'un certain temps en mode veille, le combiné passe en mode économie d'énergie. L'écran n'est maintenant plus éclairé. Appuyez sur une touche quelconque pour activer le mode veille.

<sup>1</sup> **VMWI**: **V**isual **M**essage **W**aiting **I**ndication = Affichage optique de nouveaux messages.

## Touches de navigation

Les touches softkey (4et 17) sont occupées par des fonctions différentes dans les divers menus. Dans ce mode d'emploi, elles sont toujours dénommées selon les textes inscrits ci-dessus à l'écran.

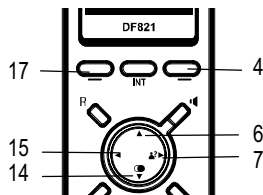

Touche	En mode veille	Dans le menu
4	- Ouvrir le répertoire	- Reculer d'une position
6		- Feuilleter dans les menus - Modifier les paramètres
7	- Ouvrir la liste d'appels	- Modifier les paramètres
14	- Ouvrir la liste de répétition automatique des derniers numéros	- Feuilleter dans les menus - Modifier les paramètres
15		- Modifier les paramètres
17	- Ouvrir le menu principal	- Ouvrir le menu affiché

## Navigation dans le menu

Vous pouvez accéder à toutes les fonctions via différents menus. La structure de menu vous montre comment accéder à la fonction désirée

☞ page 35.

Menu	Ouvrir le menu principal
▲ / ▼	Sélectionner le sous-menu désiré
Sélect	Ouvrir le sous-menu
▲ / ▼	Sélectionner la fonction désirée

Sélect	Ouvrir la fonction
▲ / ▼	Sélectionner le paramétrage désiré
☞	Saisir des chiffres ou des lettres via le pavé numérique
Sélect	Confirmer les entrées
Retour	Reculer d'une position
☞	Annuler les opérations de programmation / de sauvegarde, mode veille

☞ Chaque opération est automatiquement interrompue si vous n'effectuez pas de saisie dans les 30 secondes.

## Créer des enregistrements dans le répertoire - exemple

Pour tous les réglages, procédez comme dans cet exemple.

Menu	Ouvrir le menu
▲ / ▼, Répertoire, Sélect	Sélectionner le répertoire et confirmer
▲ / ▼, Ajouter, Sélect	Sélectionner la fonction et confirmer
☞, ▼	Saisir le nom et continuer
☞, ▼	Saisir le numéro d'appel et continuer
◀ / ▶, Ok	Sélectionner la mélodie et confirmer

☞ Maintenir la touche # appuyée pendant 2 secondes pour passer des majuscules aux minuscules.

# Téléphoner

## 5 Téléphoner

### Prendre un appel

,  ou  Prendre l'appel

### Terminer la communication

 ou  Terminer la communication

### Allumer et éteindre le combiné

Vous pouvez éteindre le combiné pour épargner les piles rechargeables.

3 sec.  Éteindre le combiné



2 sec.  Allumer le combiné

### Appeler

 Composer le numéro d'appel (max. 24 chiffres)

**Efface** En cas de saisie erronée, effacer le dernier chiffre



 Composer le numéro

 Vous pouvez appuyer d'abord sur la touche de communication  / touche mains-libres  et obtenir ainsi la tonalité. Les chiffres saisis de votre numéro d'appel seront immédiatement composés. La correction individuelle de chiffres du numéro d'appel n'est pas possible quand la communication est établie de cette manière.

### Répétition automatique des derniers numéros

Votre téléphone enregistre les 20 derniers numéros composés dans une liste de répétition automatique des derniers numéros. Autres informations  page 33

 Ouvrir la liste de répétition automatique des derniers numéros



 ou ,  Sélectionner l'enregistrement et établir la communication

### Rappeler des appels entrés

Votre téléphone enregistre 30 appels dans une liste d'appels  page 32.

Les nouveaux appels sont pourvus d'une \*.



 Ouvrir la liste d'appels

 ou ,  Sélectionner l'enregistrement et établir la communication

### Composer des numéros d'appel à partir du répertoire

Vous devez avoir enregistré des numéros dans le répertoire  page 29 et 32.



**Répert** Ouvrir le répertoire

 ou ,  Sélectionner l'enregistrement et établir la communication

### Téléphoner en interne<sup>1</sup>

#### Téléphoner en interne



Vous devez avoir déclaré deux ou plusieurs combinés (CB1, CB2, ...) sur votre base pour pouvoir téléphoner gratuitement en interne.

CB1: **INT**,  ou , **Sélect** Composer le numéro interne du combiné désiré

CB2:  Prendre une communication interne sur un autre combiné

CB1 / CB2:  Terminer la communication interne

#### Transférer des communications externes en interne

CB1: **INT**,  ou , **Sélect** Composer un numéro interne pendant la communication externe.



CB2:  Prendre une communication interne sur un autre combiné

CB1:  Transférer la communication

<sup>1</sup> Téléphoner en interne n'est possible qu'avec au moins deux combinés  "Contrôler le contenu de l'emballage" à la page 25.

## Intercommunication / Va-et-vient

Vous pouvez, pendant une communication externe, composer le numéro d'un autre combiné, pour intercommuniquer. Le correspondant externe est maintenu en ligne pendant que vous parlez avec le correspondant interne. Vous pouvez répéter cette opération autant de fois que vous le désirez.



CB1: **INT**,  
 ou , **Sélect** Composer un numéro interne pendant la communication externe.

CB2:  Prendre une communication interne sur un autre combiné

CB1: **INT** Changer de correspondant

## Mener des conférences téléphoniques

Une communication externe peut être transformée en conférence téléphonique avec un autre correspondant interne.

CB1: **INT**,  
 ou , **Sélect** Composer un numéro interne pendant la communication externe.

CB2:  Prendre une communication interne sur un autre combiné

CB1: Maintenir **INT** appuyée La conférence démarre

CB1: **INT** Continue seulement la communication externe

CB1 / CB2:  Terminer la conférence

## Régler le volume sonore de l'écouteur

Vous disposez de 5 sensibilités pour régler le volume pendant une communication.



 ou  Sélectionner le volume sonore désiré

## Affichage de la durée de la communication

Pendant une communication, sa durée s'affiche en heures, minutes et secondes.

## Mode mains-libres

Utilisez cette fonction pour entendre le correspondant par l'intermédiaire du haut-parleur.

 Activer le mode mains-libres  
 Désactiver le mode mains-libres

## Mettre le microphone du combiné sur silencieux

Pendant une communication, vous pouvez activer et désactiver le microphone du combiné.

**Muet** Désactiver le microphone (régler sur silencieux)  
**Parler** Activer le microphone

## Verrouillage du clavier

Le verrouillage empêche que vous n'appuyiez sur des touches par inadvertance.

2 sec.  Activer le verrouillage du clavier

 Lorsque le verrouillage du clavier est activé, vous pouvez comme d'habitude réceptionner des appels entrants.

2 sec.  Désactivation du verrouillage des touches

## Mélodie de sonnerie d'appel du combiné

Vous pouvez désactiver la mélodie de la sonnerie d'appel du combiné.

2 sec.  Désactiver la mélodie de sonnerie d'appel

2 sec.  Activer la mélodie de sonnerie d'appel

## Chercher le combiné (paging)

Si vous avez perdu votre combiné, vous pouvez le retrouver facilement grâce à un son de recherche.

Sur la base   Démarrer le son de recherche

 ou  ou **Ok** Terminer le son de recherche

# Répertoire/Liste d'appels

## 6 Répertoire/Liste d'appels

### Répertoire



Vous pouvez enregistrer 100 numéros d'appel et le nom y afférant dans votre répertoire.

Les noms peuvent avoir au maximum 12 positions, les numéros d'appel 24 chiffres.

- Saisissez toujours les numéros d'appel avec l'indicatif afin que le téléphone puisse aussi attribuer les communications locales entrantes à un enregistrement du répertoire.
- Si la capacité de la mémoire est épuisée, l'écran affiche le message "Mém. saturée" lors de la prochaine sauvegarde. Afin de créer à nouveau de la place, vous devez d'abord effacer un autre enregistrement.
- Les enregistrements du répertoire sont rangés par ordre alphabétique. Pour accéder directement à l'enregistrement désiré, appuyez sur l'initiale correspondante.

### Saisir le nom

Des lettres sont gravées sur les touches numériques. En appuyant plusieurs fois sur la touche correspondante, vous pouvez saisir des lettres et des chiffres.

	Entrer des espaces
	Effacer un caractère
Maintenir 	Effacer tous les caractères



Pour saisir deux fois la même lettre, appuyez sur la lettre correspondante. Attendez que le curseur soit passé derrière la lettre. Puis tapez la lettre une nouvelle fois.





### Liste d'appels

30 numéros d'appel en tout peuvent être sauvegardés dans une liste d'appels.







L'affichage du numéro d'appel (**CLIP**<sup>1</sup>) est un service confort de votre opérateur. Votre téléphone affiche les numéros d'appel à l'écran si votre opérateur supporte ce service. Veuillez lui demander de plus amples informations.



### Faire afficher des numéros de la liste d'appels





 ,  /  ,  Ouvrir la liste d'appels et sélectionner l'enregistrement



### Sauvegarder des numéros d'appel dans le répertoire à partir de la liste d'appels

Vous pouvez enregistrer un numéro d'appel dans le répertoire directement à partir de la liste d'appels.

 ,  /  ,  Ouvrir la liste d'appels et sélectionner l'enregistrement

 ,  /   
 ,  Démarrer l'enregistrement

  Saisir le nom et continuer  
  Modifier le numéro, le cas échéant, et continuer

 /  ,  Sélectionner la mélodie et confirmer



Dès que le numéro a été enregistré dans le répertoire avec un nom, celui-ci apparaît également dans la liste d'appels.

<sup>1</sup> **CLIP**: Calling Line Identification Presentation = Affichage du numéro d'appel d'un correspondant.



## Effacer des numéros de la liste d'appels

Effacer des numéros individuels

, / , Sélect Ouvrir la liste d'appels et sélectionner l'enregistrement

Menu , /

Effacer , Sélect Activer l'effacement

Ok ou Retour Confirmer ou annuler l'effacement

Effacer tous les numéros

, Sélect Ouvrir la liste d'appels

Menu , /

Tout effacer , Sélect Activer l'effacement

Ok ou Retour Confirmer ou annuler l'effacement

## Liste de répétition automatique des derniers numéros

20 numéros d'appel en tout peuvent être sauvegardés dans une liste de répétition automatique des derniers numéros.

### Faire afficher les numéros d'appel à partir de la liste de répétition automatique des derniers numéros

, / , Sélect Ouvrir la liste de répétition automatique des derniers numéros et sélectionner l'enregistrement

### Sauvegarder des numéros d'appel à partir de la liste de répétition automatique des derniers numéros

Vous pouvez enregistrer un numéro d'appel directement à partir de la liste de répétition automatique des derniers numéros.

, / , Sélect Ouvrir la liste de répétition automatique des derniers numéros et sélectionner l'enregistrement

Menu , /

Ajouter au rép. , Sélect Démarrer l'enregistrement

, Saisir le nom et continuer

## Répertoire/Liste d'appels

, Modifier le numéro, le cas échéant, et continuer

/ , Ok Sélectionner la mélodie et confirmer

### Effacer des numéros d'appel à partir de la liste de répétition automatique des derniers numéros

Effacer des numéros individuels

, / , Sélect Ouvrir la liste de répétition automatique des derniers numéros et sélectionner l'enregistrement

Menu , /

Effacer , Sélect Activer l'effacement

Ok ou Retour Confirmer ou annuler l'effacement

Effacer tous les numéros

, Sélect Ouvrir la liste de répétition automatique des derniers numéros

Menu , /

Tout effacer , Sélect Activer l'effacement

Ok ou Retour Confirmer ou annuler l'effacement

## Installations à postes supplémentaires /

### 7 Installations à postes supplémentaires / Services confort

#### Touche R sur des installations à postes supplémentaires

Si votre téléphone est raccordé à une installation à postes supplémentaires, vous pouvez, via la **touche R**, tirer profit de certaines fonctions comme par ex. le transfert d'appels et le rappel automatique. Veuillez lire le mode d'emploi de votre installation à postes supplémentaires pour connaître le temps de flash que vous devez paramétrer pour tirer profit de ces fonctions. Le revendeur, auprès duquel vous avez acheté l'installation, vous informera si votre téléphone fonctionne impeccablement sur ce genre d'installation. Vous réglez le temps de flash via le menu. La page 36 vous donnera la position dans le menu.

#### Saisir manuellement la pause de numérotation

Vous pouvez, après le chiffre de la ligne principale, insérer **manuellement** une **pause de numérotation** pour pouvoir continuer à composer le numéro sans avoir à attendre la tonalité.

2 sec.  Insérer une pause de numérotation

Après le chiffre de la ligne principale, le numéro est composé au bout d'un temps déterminé.



La pause peut également être enregistrée lors de la saisie de numéros d'appel dans le répertoire.

#### Touche R et services confort

Votre téléphone supporte les services confort de votre opérateur, comme par ex. le va-et-vient, la signalisation d'appel en instance et la conférence. Vous pouvez les utiliser via la **touche R**. Veuillez demander à votre opérateur quel temps de flash vous devez paramétrer pour tirer profit des services confort. Contactez-le également pour la déconnexion de ces services. Vous paramétrez le temps de flash via le menu. La page 36 vous donnera la position dans le menu.

#### Affichage du numéro d'appel (CLIP<sup>1</sup>)



L'affichage du numéro d'appel est un service confort de votre opérateur. Veuillez lui demander de plus amples informations.

Si cette fonction est à votre disposition sur votre ligne téléphonique, le numéro du correspondant vous sera affiché dès que le téléphone sonnera. Si votre correspondant a bloqué la transmission de son numéro, un message correspondant sera affiché. Le numéro d'appel ne peut pas être affiché et ne peut donc être enregistré dans la liste d'appels.

#### Répondeur dans le réseau téléphonique (boîte vocale)

Le répondeur dans le réseau téléphonique est un service confort offert par de nombreux opérateurs. Si votre opérateur tient un répondeur à votre disposition dans le réseau téléphonique, une icône vous informera des nouveaux messages (VMWI<sup>2</sup>). Vous ne pouvez disposer de cette fonction que si votre opérateur offre ce service. Veuillez lui demander de plus amples informations.

<sup>1</sup> **CLIP**: Calling Line Identification Presentation = Affichage du numéro d'appel d'un correspondant.

<sup>2</sup> **VMWI** : Visual Message Waiting Indication = Affichage optique de nouveaux messages.

## 8 Structure du menu

### Menu principal

Vous parvenez au menu principal en appuyant sur la touche softkey **Menu**. Vous trouverez comment vous déplacer dans le menu et effectuer des saisies à la page 28.

#### Liste des appels

Sélectionner l'enregistrement	<b>Menu</b>	Ajouter au rép.	Nom:	
			Numéro	
			Mélod.	Mél 1-15
	Effacer		Ok/Retour	
	Tout effacer		Ok/Retour	

#### Répertoire

Voir	Sélectionner l'enregistrement	<b>Menu</b>	Editer
			Effacer
Ajouter	Nom:		
	Numéro		
	Mélod.	Mél 1-15	
Editer	Nom:		
	Numéro		
	Mélod.	Mél 1-15	
Effacer	Sélectionner l'enregistrement	Ok/Retour	
Tout effacer	Ok/Retour		
Etat répertoire			
Copie répert.	Combiné 1-6		

### Heure/Alarme

Date & Heure	Format date	JJ-MM-AAAA
		MM-JJ-AAAA
	Format Heure	12 Heures
		24 Heures
	Réglage Date	
	Réglages Heure	(▲) / (▼) AM/PM
Alarme	Alarme Off	
	Alarme On	(▲) / (▼) AM/PM
	Sonnerie alarme	Mélodie 1
		Mélodie 2
		Mélodie 3

# Structure du menu

## Réglages Combiné

Réglages audio	Vol. H-parleur	1-5	
	Volume d'écoute	1-5	
Réglages sonn.	Sonnerie Interne	Mélod.	
	Sonnerie Externe	Mélod.	
Alertes Sonores	Volume Sonnerie	Off, 1-5	
	Bip touches	Off/On	
	Batterie faible	Off/On	
	Hors Portée	Off/On	
Langue	Deutsch		
	Français		
	Italiano		
	English		
Renommer combiné			
Contraste	Niveau 1-5		
Réponse auto	Off/On		
Restriction	PIN:	Mode Restriction	Off/On
		Num. interdit	Numéro 1-4
Numéro d'urgence	PIN:	Numéro1	
		Numéro2	
		Numéro3	

Choix base	Base 1-4
Rég. CB Défaut	PIN:  Ok/Retour

## Réglages Base

Annuler Combiné	PIN:	Combiné 1-6
Numérotation	FV/DC	
Touche R	Court/Medium/Long	
Modifier PIN	PIN:	
	Nv PIN:	
	Confirm:	
Numéro d'urgence	PIN:	Numéro1
		Numéro2
		Numéro3
Sonnerie 1	Off/On	
Rég. défaut base	PIN:	Ok/Retour

## Association

Base 1	PIN:
Base 2	PIN:
Base 3	PIN:
Base 4	PIN:

## 9 Fonctions particulières

### Système de numérotation

Vous pouvez faire fonctionner votre téléphone aussi bien sur les raccordements analogiques (numérotation par impulsions/DC) que sur les nouveaux raccordements numériques (numérotation par tonalité/FV). Le système de numérotation est programmé via le menu. La page 36 vous donnera la position dans le menu.

### Numérotation temporaire par tonalité

Si vous ne pouvez utiliser votre téléphone qu'avec la numérotation par impulsions, vous n'avez pas besoin de renoncer aux avantages de la numérotation par tonalité (par ex. : consultation d'un répondeur dans le réseau téléphonique). Vous pouvez passer provisoirement à la numérotation par tonalité pendant que vous passez une communication.



Appuyer dessus pendant la communication

Quand la communication est terminée, la numérotation par impulsions est automatiquement rétablie.

### Alarme

Cette fonction vous permet d'être alerté par votre combiné à un moment donné. La page 35 vous donnera la position dans le menu.

### Discrimination d'appel

La discrimination d'appel empêche les combinés de composer des numéros d'appel que vous avez mis en mémoire. Vous pouvez mettre 4 numéros de discrimination d'appel pouvant être composés de 4 chiffres chacun. La page 36 vous donnera la position dans le menu.

### Numéros de secours

Vous pouvez mettre en mémoire jusqu'à 3 numéros d'appel qui, malgré la discrimination d'appel activée, peuvent être composés. La page 36 vous donnera la position dans le menu.

### Exemple

Le "017" est paramétré comme numéro de discrimination d'appel. Tous les numéros d'appel commençant par "017" sont bloqués (0170 - 0179). Le "0173" est enregistré comme numéro de secours. Il est ainsi possible,

malgré la discrimination d'appel activée, de composer des numéros commençant par "0173".

### Première sonnerie

Si vous mettez cette fonction sur "Arrêt", les données CLIP seront affichées à l'entrée d'appels avec la première sonnerie audible pour vous. À la page 36 vous trouverez la position "Sonnerie 1" dans le menu.

### Copier des enregistrements du répertoire

Vous pouvez copier le répertoire d'un combiné sur un autre. Cette fonction est à votre disposition quand plusieurs combinés sont déclarés sur la base.

Menu	Ouvrir le menu
▲ / ▼ Répertoire	,
Sélect	Sélectionner le répertoire, confirmer
▲ / ▼ Copie répert.	,
Sélect	Sélectionner "copie répert.", confirmer
▲ / ▼, Sélect	Sélectionner le combiné et confirmer
Ok / Annule	Confirmer sur le combiné récepteur ou annuler l'opération

# Élargissement du système téléphonique

## 10 Élargissement du système téléphonique

Le mode standard international normé **GAP**<sup>1</sup> règle la compatibilité entre les combinés et les bases de fabricants différents. Il est ainsi possible d'intégrer ensemble des appareils SWITEL et des appareils d'autres fabricants dans un système téléphonique. Il est toutefois possible que certaines fonctions ne soient pas disponibles.



### Plusieurs combinés

Vous pouvez déclarer 6 combinés sur votre base.

#### Déclaration de combinés

Avant de déclarer un combiné, vous devez mettre la base en mode de déclaration.

Maintenir appuyée  Mode de déclaration démarré

Déclarez maintenant le combiné  page 36. Pour cela, utilisez le code PIN actuellement paramétré  page 36.

Un numéro d'appel interne est attribué automatiquement au combiné après la déclaration. Ce numéro s'affiche à l'écran.

 Pour déclarer des combinés d'autres fabricants, veuillez lire leur mode d'emploi.

#### Annulation de combinés

 Vous ne pouvez annuler un combiné d'une base que par un autre, déclaré sur cette base.

Les combinés sont annulés via le menu. La page 36 vous donnera la position dans le menu.

### Plusieurs bases

Vous pouvez élargir la portée de votre combiné si vous le déclarez simultanément à plusieurs bases. Vous pouvez le déclarer simultanément sur 4 bases différentes. Chaque base a besoin d'une prise téléphonique individuelle. Ces raccordements peuvent porter le même numéro d'appel ou des numéros différents.

Sélection de la base  page 36.

 Les communications en cours ne peuvent pas être transférées d'une base à l'autre.

<sup>1</sup> **GAP: Generic Access Profile** = Standard pour l'action conjointe de combinés et de bases de fabricants différents.

## 11 En cas de problèmes

### Hotline de service

Si vous avez des problèmes avec votre téléphone, contrôlez d'abord les indications suivantes. En cas de problèmes techniques, vous pouvez également vous adresser à notre ligne directe, tél. 0900 00 1675 (coûts Swiscom à la date d'impression de ce manuel : CHF 2.00 / Min). Si vous avez des droits de garantie, adressez-vous à votre revendeur. La durée de la garantie est de 2 ans.

### Questions et réponses

Questions	Réponses
Pas de liaison possible avec la base	- Contrôlez si vous vous êtes bien identifié sur la base par le code PIN correct. 36
Pas de communication téléphonique possible	- Le téléphone n'est pas correctement raccordé ou est en dérangement. N'utilisez que le câble de raccordement téléphonique fourni avec l'appareil. - Testez avec un autre téléphone si votre raccordement téléphonique fonctionne. - Le bloc secteur n'est pas branché ou il y a une panne totale de courant. - Les piles rechargeables sont vides ou défectueuses. - Vous vous êtes trop éloigné de la base. - Programmation erronée du système de numérotation ☞ page 36.
La liaison est hachée, est coupée	- Vous vous êtes trop éloigné de la base. - Mauvais lieu d'installation de la base.

Le système ne réagit plus	- Remettez toutes les fonctions en configuration usine ☞ page 36. - Retirez le bloc secteur de la prise de courant pendant un court instant.
Les piles rechargeables sont vides en très peu de temps	- Les piles rechargeables sont vides ou défectueuses. - Placez le combiné correctement sur la base. Nettoyez les surfaces de contact du combiné et de la base avec un chiffon doux et non pelucheux. - Posez le combiné sur la base et laissez-le pendant 14 heures .
L'affichage du numéro d'appel (CLIP <sup>1</sup> ) ne fonctionne pas	- L'affichage du numéro d'appel est un service confort de votre opérateur. Veuillez lui demander de plus amples informations. - Le correspondant a bloqué la transmission de son numéro d'appel.

<sup>1</sup> CLIP: Calling Line Identification Presentation = Affichage du numéro d'appel d'un correspondant.

# Caractéristiques techniques

## 12 Caractéristiques techniques

### Caractéristiques techniques

Caractéristique	Valeur
Standard	<b>DECT<sup>1</sup>-GAP<sup>2</sup></b>
Alimentation en courant (base)	Entrée : 230 V <sub>AC</sub> , 50 Hz Sortie : 6 V <sub>DC</sub> , 300 mA
Alimentation en courant (chargeur)	Entrée : 230 V <sub>AC</sub> , 50 Hz Sortie : 6 V <sub>DC</sub> , 200 mA
Portée	Extérieur : env. 300 m Intérieur : env. 50 m
Mode veille	Jusqu'à 100 h
Durée max. de communication	Jusqu'à 10 h
Piles rechargeables	2 x AAA NiMH 1,2 V
Système de numérotation	FV (DTMF) DC (par impulsions)
Température ambiante autorisée	10°C à 30°C
Humidité atmosphérique relative autorisée	20% à 75%
Fonction de flash	Court, Medium, Long

<sup>1</sup> **DECT**: Digital Enhanced Cordless Telecommunication = Standard pour les téléphones sans fil.

<sup>2</sup> **GAP**: Generic Access Profile = Standard pour l'action conjointe de combiné et de base de fabricants différents.

### Réglages usine

#### Combiné

Les paramètres usine sont rétablis via le menu. La page 36 vous donnera la position dans le menu.

Volume Sonnerie	Niveau 5	Volume d'écoute	Niveau 3
Sonnerie Externe	Mélodie 2	Vol. H-parleur	Niveau 3
Sonnerie Interne	Mélodie 1	Contraste	Niveau 3
Bip touches	On	Hors Portée	On
Batterie faible	On	Sonnerie 1	On
Nom:	DF 821	Langue	Deutsch

#### Base

Les paramètres usine sont rétablis via le menu. La page 36 vous donnera la position dans le menu.

Numérotation	FV	PIN:	0000
Touche R	Court	Réponse auto	On
Sonnerie	Mélodie 1	Volume Sonnerie	Niveau 5

### Déclaration de conformité

Cet appareil répond aux exigences des directives de l'union européenne (UE) :

1999/5/CE Directive sur les installations de radio et de télécommunication et la reconnaissance réciproque de leur conformité. La conformité avec la directive mentionnée ci-dessus est confirmée par le signe CE placé sur l'appareil.

Pour obtenir la déclaration de conformité intégrale, veuillez vous servir du téléchargement gratuit de notre site Internet [www.switel.com](http://www.switel.com).





### 13 Remarques d'entretien / Garantie

#### Remarques d'entretien

- Nettoyez les surfaces du boîtier avec un chiffon doux et non pelucheux.
- N'utilisez pas de produits d'entretien ou de solvants.

#### Garantie

Les appareils SWITEL sont fabriqués selon les procédés les plus modernes et sont contrôlés. Des matériels sélectionnés et des technologies de pointe ont pour effet un fonctionnement irréprochable et une longue durée de vie. La garantie ne rentre pas en jeu si l'exploitant du réseau téléphonique ou une installation à postes supplémentaires éventuellement intercalée est responsable du dysfonctionnement de l'appareil. La garantie n'est pas valable pour les piles, les piles rechargeables ou les packs de piles utilisés dans les produits. La durée de garantie est de 24 mois à partir de la date d'achat.

Pendant la période de garantie, tous les vices provenant de défauts de fabrication ou de matériel seront éliminés. Le droit à la garantie expire en cas d'intervention de l'acheteur ou de tiers. Les dommages provenant d'un maniement ou d'une manipulation incorrects, d'une usure naturelle, d'une mauvaise mise en place ou d'une mauvaise conservation, d'un raccordement ou d'une installation incorrects ainsi que d'un cas de force majeure ou autres influences extérieures sont exclus de la garantie. En cas de réclamations, nous nous réservons le droit de réparer, de remplacer les pièces défectueuses ou de d'échanger l'appareil. Les composants remplacés ou les appareils échangés deviennent notre propriété. Les demandes de dommages et intérêts sont exclues tant qu'elles ne reposent pas sur l'intention ou une négligence grossière du fabricant.

Si votre appareil devait malgré tout présenter une défektivité pendant la période de garantie, veuillez vous adresser, muni de la quittance d'achat, uniquement au magasin où vous avez acheté votre appareil SWITEL. Vous ne pouvez faire valoir vos droits à la garantie selon ces dispositions qu'auprès de votre revendeur exclusivement. À l'échéance des deux ans après l'achat et la remise de nos produits, les droits en matière de garantie ne peuvent plus être revendiqués.

## 14 Index

### A

Affichage de numéros d'appel, 32  
Affichage du numéro d'appel, 34  
Alarme, 37  
Allumer, 30  
Annulation, 38  
Appeler, 30

### B

Base, 25, 38

### C

Caractéristiques techniques, 40  
Chargement, 26  
Chargeur, 25  
Chercher, 31  
CLIP, 34  
Combiné, 38  
Communications internes, 30  
Composer des numéros, 30  
Conférences téléphoniques, 31  
Consignes de sécurité, 24  
Contenu de l'emballage, 25  
Copier des enregistrements du répertoire, 37  
Créer, 29

### D

Date, 26  
Déclaration, 38  
Déclaration de conformité, 40  
Décrocher, 30  
Désactivation du micro, 31  
Discrimination d'appel, 37  
Durée de la communication, 31

### E

Écran, 28  
Effacer, 33  
Élargissement, 38  
Éléments de manipulation, 27  
Emploi, 28  
Enregistrements du répertoire, 29  
Éteindre, 30

### F

Fonctions, 37

### G

Garantie, 41

### H

Heure, 26  
Hotline de service, 39

### I

Icônes, 28  
Icônes à l'écran, 28  
Installations à postes supplémentaires, 34  
Intercommunication, 31

### L

Langue de l'écran, 26  
Liste d'appels, 32  
Liste de répétition automatique des derniers numéros, 33

### M

Mélodie de sonnerie d'appel, 31  
Menu principal, 35  
Mise en service, 25  
Mise sur silencieux, 31  
Mode ÉCO, 26  
Mode économie d'énergie, 28  
Mode mains-libres, 31  
Mode veille, 28

### N

Niveau de chargement des piles rechargeables, 26  
Notations, 28  
Numéros de secours, 37  
Numérotation par impulsions, 37  
Numérotation par tonalité, 37  
Numérotation temporaire par tonalité, 37

### P

Paging, 31  
Poser des piles rechargeables, 26  
Première sonnerie, 37  
Prise d'appel, 26, 30  
Problèmes, 39

### Q

Questions et réponses, 39

### R

Raccrocher, 30  
Rappel, 30  
Réduction du rayonnement, 26  
Réglages usine, 40  
Remarques d'entretien, 41  
Répertoire, 30, 32  
Répétition automatique des derniers numéros, 30, 33  
Répondeur dans le réseau téléphonique, 34

### S

Saisie de nom, 32  
Saisie de texte, 32  
Saisir manuellement la pause de numérotation, 34  
Sauvegarder, 29, 32, 33  
Services confort, 34  
Structure du menu, 35  
Suppression d'erreurs, 39  
Système de numérotation, 37

### T

Téléphoner, 30  
Terminer la communication, 30  
Touche R, 34  
Touches de navigation, 29  
Transfert, 30  
Transfert de communication, 30

### V

Va-et-vient, 31  
Verrouillage du clavier, 31  
VMWI, 34  
Volume sonore de l'écouteur, 31

1	Indicazioni di sicurezza . . . . .	44
2	Mettere in funzione il telefono . . . . .	45
3	Elementi di comando . . . . .	47
4	Informazioni introduttive . . . . .	48
5	Compiere telefonate . . . . .	51
6	Rubrica telefonica/Elenco chiamate . . .	53
7	Impianti telefonici interni / Servizi aggiuntivi . . . . .	55
8	Struttura di menu . . . . .	56
9	Funzioni speciali . . . . .	58
10	Ampliamento del sistema telefonico . . .	59
11	In presenza di problemi . . . . .	60
12	Specifiche tecniche . . . . .	61
13	Consigli per la cura / Garanzia . . . . .	62
14	Indice alfabetico . . . . .	63

# Indicazioni di sicurezza

## 1 Indicazioni di sicurezza

Leggere attentamente le presenti istruzioni per l'uso.

### Impiego conforme agli usi previsti

Il presente telefono consente di svolgere telefonate all'interno di una rete telefonica. Qualsiasi altro impiego è considerato come non conforme agli usi previsti. Non sono consentite modifiche o trasformazioni non autorizzate. Non aprire per nessuna ragione l'apparecchio autonomamente, né compiere riparazioni di propria iniziativa.

### Luogo di installazione

Evitare un'esposizione a fumo, polvere, vibrazioni, sostanze chimiche, umidità, calore e raggi solari diretti.

Non utilizzare l'unità portatile in aree esposte al rischio di deflagrazione.

### Alimentatore di rete



**Attenzione:** Utilizzare solo l'alimentatore a spina fornito in dotazione visto che altri alimentatori di rete potrebbero addirittura danneggiare il telefono. Non ostacolare il libero accesso all'alimentatore a spina con mobili o altri oggetti simili.

### Accumulatori ricaricabili



**Attenzione:** Non gettare gli accumulatori ricaricabili nel fuoco. Utilizzare solo accumulatori dello stesso tipo. Osservare la corretta polarità! Pericolo di esplosione durante il caricamento dell'accumulatore in caso di errata polarità.

### Caduta di tensione

In caso di caduta di tensione non è possibile compiere chiamate con il telefono. Si consiglia di ricorrere in caso di emergenza ad un telefono con filo in grado di funzionare anche senza alimentazione elettrica esterna.

### Apparecchiature mediche



**Attenzione:** Non utilizzare il telefono in prossimità di apparecchiature mediche. Non è infatti possibile escludere il rischio di possibili interferenze.

Telefoni **DECT**<sup>1</sup> possono causare un fastidioso ronzio in apparecchi acustici.

## Smaltimento

Procedere allo smaltimento dell'apparecchio esaurito consegnandolo presso uno dei punti di raccolta istituiti dalla propria società di smaltimento rifiuti comunale (per es. centro di riciclo materiali). Il simbolo riportato qui a lato indica che non è assolutamente consentito smaltire l'apparecchio assieme ai normali rifiuti domestici! Secondo quanto previsto dalla legge sugli apparecchi elettrici ed elettronici, i proprietari di apparecchi esauriti sono per legge tenuti alla consegna di tutti gli **apparecchi elettrici ed elettronici** presso un centro di rilievo rifiuti in raccolta differenziata.

**Consegnare gli accumulatori** per lo smaltimento presso rivenditori al dettaglio di batterie o centri di raccolta che mettono a disposizione appositi contenitori.

Smaltire **confezioni ed imballaggi** in base a quanto indicato dalle norme in vigore a livello locale.



<sup>1</sup> **DECT:** Digital Enhanced Cordless Telecommunication = Standard per telefoni senza cavo.

## 2 Mettere in funzione il telefono

### Indicazioni di sicurezza



**Attenzione:** Prima della messa in funzione, leggere attentamente le indicazioni di sicurezza riportate al capitolo 1.

### Verificare il contenuto della confezione

La confezione contiene:

Contenuto	Modello DF 82x			
	821	822 <sup>1</sup>	823 <sup>1</sup>	824 <sup>1</sup>
Stazione base con alimentatore	1	1	1	1
Stazione di carica con alimentatore	-	1	2	3
Unità portatile	1	2	3	4
Cavo di collegamento telefonico	1	1	1	1
Accumulatori	2	4	6	8
Istruzioni per l'uso	1	1	1	1

<sup>1</sup> Per ulteriori informazioni riguardo la disponibilità di questo set telefonico si prega di visitare il sito [www.switel.com](http://www.switel.com).

### Collegare la stazione base



**Attenzione:** Montare la stazione base con una distanza minima di 1 m da altri apparecchi elettronici in modo da evitare interferenze reciproche.

Procedere al collegamento della stazione base seguendo quanto raffigurato nella figura. Utilizzare per motivi di sicurezza solo l'alimentatore di rete oltre al cavo di collegamento telefonico fornito in dotazione.

Presa telefonica

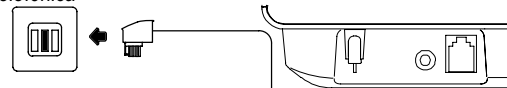

Presa elettrica

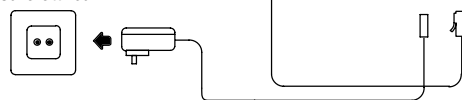

**Attenzione:** Utilizzare per la stazione base l'alimentatore di rete modello no. SY-06030-GS, dati di output: 6 V<sub>DC</sub>, 300 mA.

# Mettere in funzione il telefono

## Collegare la stazione di carica<sup>1</sup>

Procedere al collegamento della stazione di carica seguendo la figura. Per motivi di sicurezza si prega di utilizzare soltanto l'alimentatore di rete fornito in dotazione.

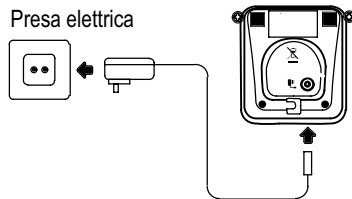

**Attenzione:** Utilizzare per la stazione di carica l'alimentatore di rete modello no. SY-06020-GS, dati di output: 6 V<sub>DC</sub>, 200 mA.

## Inserire gli accumulatori

Aprire il vano accumulatori. Inserire gli accumulatori nell'apposito vano accumulatori. Utilizzare soltanto gli accumulatori forniti in dotazione. Chiudere infine il vano accumulatori.

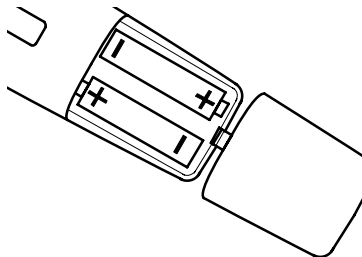

## Caricare gli accumulatori



Riporre l'unità portatile in sede di prima messa in funzione per **minimo 14 ore** nella stazione base / stazione di carica.

L'unità portatile si surriscalda durante il processo di carica. Questo è un fenomeno normale e non pericoloso. Evitare di caricare l'unità portatile con dispositivi di carica differenti o estranei. Lo **stato di carica** attuale è visualizzato sul display:



Carico



Metà carico



Debole



Scarico

## Impostare data e ora dell'unità portatile

Una voce di menu consente di impostare data e ora. A pagina 56 è indicata la posizione da scorrere nel menu.

## Impostare la lingua di display

La lingua di display è disponibile in tedesco, inglese, italiano e francese. La lingua è impostabile nel rispettivo menu. A pagina 57 è indicata la posizione da scorrere nel menu.

## Accettazione di chiamata automatica

L'attivazione di questa funzione consente di ricevere automaticamente una chiamata estraendo semplicemente l'unità portatile dalla stazione base. L'accettazione di chiamata automatica è attivata o disattivata nel menu. Si rimanda alla pagina 57 dove è indicata la posizione "Risp. Auto" nel menu.

## Riduzione delle radiazioni (modalità ECO)













Le radiazioni emesse dal portatile in modalità di conversazione sono considerevolmente ridotte rispetto a quelle emesse da telefoni cordless a standard DECT.

<sup>1</sup> Vale solo per set telefonici con minimo due unità portatili  
☞ "Verificare il contenuto della confezione" a pagina 45.

## 3 Elementi di comando

I tasti del telefono riportati nel presente manuale d'istruzioni per l'uso sono raffigurati sotto forma di simboli uniformi all'interno di un riquadro. Sono possibili lievi scostamenti dei simboli dei tasti sul telefono rispetto ai simboli qui raffigurati.

### Unità portatile

- 1 Ricevitore
- 2 Display
- 3 Tasto INT 
- 4 Tasto softkey di destra
- 5 Funzione vivavoce 
- 6 Verso sopra 
- 7 Verso destra  / Elenco chiamate 
- 8 Tasto di riaggancio
- 9 Modalità di stand-by 
- 10 Tasti numerici
- 11 Tasto # / Disattivare segnalazione di chiamata
- 12 Microfono
- 13 Tasto \* / Blocco tastiera / Selezione a toni temporanea
- 14 Tasto di chiamata 
- 15 Verso sotto  / Ripetizione di chiamata 
- 16 Verso sinistra 
- 17 Tasto R (flash) 
- 18 Tasto softkey di sinistra

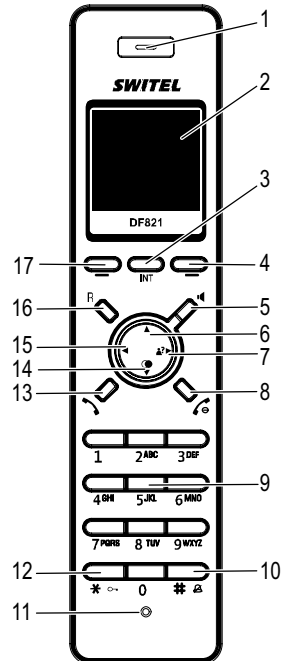

### Stazione base

- 1 Contatti di carica
- 2 Cercare unità portatile (funzione di paging) 

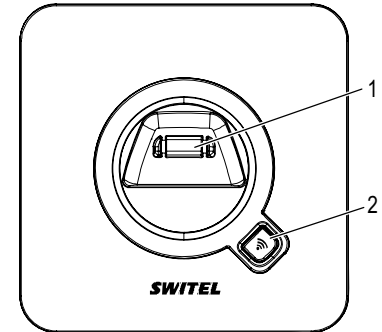

# Informazioni introduttive



## 4 Informazioni introduttive









In questo capitolo sono riportate le principali informazioni riguardo l'uso delle presenti istruzioni e del telefono.

### Modi di rappresentazione delle istruzioni per l'uso

Rappresentazione	Descrizione
	Rappresentazione dei tasti
	Premere brevemente il tasto raffigurato
2 sec. 	Premere il tasto raffigurato per 2 secondi
tenere 	Tenere premuto il tasto raffigurato
rilasciare 	Rilasciare il tasto raffigurato
	Immettere cifra o lettera
	Unità portatile squilla
	Stazione base squilla
	Estrarre l'unità portatile dalla stazione base
	Riporre l'unità portatile nella stazione base
	Rappresentazione di testi sul display
	Rappresentazione di simboli sul display
	Premere il tasto softkey  pagina 47

### Simboli e testi sul display dell'unità portatile

Simbolo	Descrizione
	Costante: Indicazione dello stato di carica delle batterie. Segmenti che scorrono: Gli accumulatori sono in fase di ricarica  pagina 46.

	Costante: Funzione allarme attivata. Lampeggiante: Allarme.
gg/mm hh:mm	Indicazione di data e ora  pagina 56.
	Costante: Chiamata in corso. Nuove voci nell'elenco chiamate. Lampeggiante: Chiamata in arrivo  pagina 51.
	Presenza di nuovi messaggi sulla segreteria telefonica integrata nella rete telefonica (VMWI <sup>1</sup> ). Servizio aggiuntivo del proprio gestore di rete telefonica  pagina 55.
	La segnalazione acustica di chiamata è disinserita  pagina 52.
	La funzione viva voce è attivata  pagina 52.
	Il blocco tastiera è attivato  pagina 52.
	Costante: Chiamata interna in corso. Lampeggiante: Chiamata interna in arrivo.
	Costante: Il collegamento con la stazione base è buono.
	Lampeggiante: Il collegamento con la stazione base si interrompe. Avvicinarsi alla stazione base.

<sup>1</sup> VMWI: Visual Message Waiting Indication = Segnalazione ottica di nuovi messaggi.



## Modalità di stand-by

In tutte le descrizioni del presente manuale di istruzioni si considera l'unità portatile in modalità di stand-by. Per passare alla modalità di stand-by, premere il tasto .

## Modalità di risparmio energetico

Trascorso un breve intervallo di tempo in modalità di stand-by, l'unità portatile passa in modalità di risparmio energetico. Fatto questo, il display non è più illuminato. Premendo un tasto qualsiasi, l'apparecchio passa in modalità di stand-by.

## Tasti di navigazione



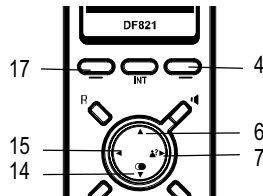

I tasti softkey (4 e 17) sono programmati con funzioni differenti in base al menu in cui ci si trova. Nelle presenti istruzioni per l'uso questi tasti sono denominati sempre in base ai testi di display visualizzati direttamente al di sopra.



Tasto	In modalità di stand-by	Nel menu
4	- Aprire la rubrica telefonica	- Tornare indietro di un livello
6		- Scorrere i menu - Modificare le impostazioni
7	- Aprire l'elenco chiamate	- Modificare le impostazioni
14	- Aprire l'elenco di ripetizione di chiamata	- Scorrere i menu - Modificare le impostazioni
15		- Modificare le impostazioni
17	- Aprire il menu principale	- Aprire il menu visualizzato

## Navigazione nel menu

I differenti menu consentono di raggiungere tutte le funzioni del telefono. Il percorso da seguire per giungere alla funzione desiderata è indicata dalla struttura di menu  pagina 56.

<b>Menu</b>	Aprire il menu principale
	Selezionare il sottomenu desiderato
<b>Selez</b>	Aprire il sottomenu
	Selezionare la funzione desiderata
<b>Selez</b>	Aprire la funzione
	Selezionare l'impostazione desiderata
	La tastiera consente di inserire numeri o lettere
<b>Selez</b>	Confermare le immissioni
<b>Indiet</b>	Tornare indietro di un livello
	Interrompere procedure di programmazione/memorizzazione, modalità di stand-by













Ogni singolo processo si interrompe automaticamente se entro 30 secondi non si procede con una immissione.

## Informazioni introduttive

### Creare voci nella rubrica telefonica - Esempio

Si consiglia di seguire quanto riportato in questo esempio per tutte le altre impostazioni che si desiderano compiere.

Menu	Aprire il menu
 /  , Rubrica, Selez	Selezionare e confermare la rubrica telefonica
 /  , Aggiungi, Selez	Selezionare e confermare la funzione
 , 	Immettere il nome e continuare
 , 	Immettere il numero telefonico e continuare
 /  , OK	Selezionare e confermare la melodia
 Tenere premuto il tasto # per 2 secondi per passare da lettere maiuscole a lettere minuscole e viceversa.	

## 5 Compiere telefonate

### Accettare una chiamata

Ricevere una chiamata

### Concludere una chiamata

Concludere una chiamata

### Attivare e disattivare l'unità portatile

Allo scopo di non solleccitare troppo gli accumulatori è possibile spegnere l'unità portatile.

3 sec Disattivare l'unità portatile

2 sec Attivare l'unità portatile

### Compiere telefonate

Immettere un numero di chiamata (max. 24 cifre)

**Canc** In caso di immissione errata, cancellare l'ultima cifra

Selezionare un numero di chiamata

È altresì possibile premere prima il tasto di chiamata /tasto di vivavoce e ottenere così il segnale di linea libera. Le cifre immesse per la composizione del numero di chiamata desiderato sono immediatamente selezionate. Nel corso di una simile chiamata non è possibile eseguire la correzione di singole cifre che compongono il numero di chiamata.

### Ripetizione di chiamata

Il telefono memorizza i 20 numeri di chiamata selezionati per ultimo in un elenco di ripetizione di chiamata. Ulteriori informazioni pagina 54.

Aprire l'elenco di ripetizione di chiamata

Scegliere la voce e instaurare un collegamento

### Richiamare una telefonata ricevuta

Il telefono memorizza 30 chiamate in un elenco chiamate pagina 53.

Nuove chiamate sono evidenziate da un \*.

Aprire l'elenco chiamate

o Scegliere la voce e instaurare un collegamento

### Selezionare numeri di chiamata dalla rubrica telefonica

Per fare questo è necessario aver precedentemente memorizzato dei numeri nella rubrica telefonica pagina 50 e 53.

**Rubri.** Aprire la rubrica telefonica

o Scegliere la voce e instaurare un collegamento

### Compiere una telefonata interna<sup>1</sup>

#### Condurre chiamate interne

Per condurre telefonate interne gratuite bisogna aver registrato due o più unità portatili (UP1, UP2, ...) presso la stazione base.

UP1: **INT**,  
 o , **Selez** Selezionare il numero di chiamata interno dell'unità portatile desiderata

UP2: Accettare una telefonata interna presso l'altra unità portatile

UP1 / UP2: Concludere la chiamata interna

#### Trasferire internamente chiamate esterne

UP1: **INT**,  
 o , **Selez** Selezionare con chiamata esterna in corso il numero interno

UP2: Accettare una telefonata interna presso l'altra unità portatile

UP1: Trasferire la chiamata



<sup>1</sup> Per compiere telefonate interne sono necessarie minimo due unità portatili "Contenuto della confezione" a pagina 45.

## Compiere telefonate

### Riscontro / Chiamata in attesa

Durante lo svolgimento di una chiamata esterna è possibile chiamare un'altra unità portatile allo scopo di consultarsi o eseguire un riscontro. Mentre è in corso la conversazione con l'interlocutore interno, la chiamata esterna è trattenuta. La procedura può essere ripetuta a piacere.

UP1: **INT**,

 o , **Selez**      Selezionare con chiamata esterna in corso il numero interno

UP2: 

Accettare una telefonata interna presso l'altra unità portatile



UP1: **INT**

Passare ad un altro interlocutore telefonico

### Condurre chiamate a conferenza

Questa funzione consente di condurre una conferenza con una chiamata esterna ed un altro interlocutore interno.

UP1: **INT**,

 o , **Selez**      Selezionare con chiamata esterna in corso il numero interno

UP2: 

Accettare una telefonata interna presso l'altra unità portatile

UP1: trattenere **INT**

Avviare la conferenza

UP1: **INT**



Continuare soltanto la chiamata esterna

UP1 / UP2: 

Concludere la conferenza

### Impostare il volume del ricevitore

Il volume è regolabile durante lo svolgimento di una chiamata in 5 livelli.

 o 

Selezionare il volume desiderato

### Visualizzazione della durata di conversazione

Durante lo svolgimento di una chiamata, la durata della telefonata è visualizzata in ore, minuti e secondi.

### Funzione vivavoce

Utilizzare questa funzione per ascoltare il partner di chiamata attraverso l'altoparlante.



Attivare la funzione vivavoce



Disattivare la funzione vivavoce

### Silenziamento del microfono nell'unità portatile

È possibile attivare e disattivare il microfono dell'unità portatile con chiamata telefonica in corso.

**MicOff**

Disattivare il microfono (silenziamento)

**Mic ON**

Attivare il microfono

### Blocco tastiera

Il blocco tastiera impedisce di premere accidentalmente dei tasti.

2 sec  

Attivare il blocco tastiera



L'attivazione del blocco tastiera consente di ricevere telefonate in arrivo come di consueto.

2 sec  

Disattivare il blocco tastiera

### Melodia di suoneria dell'unità portatile

La melodia di suoneria può essere disinserita presso l'unità portatile.

2 sec  



Disattivare la melodia di suoneria

2 sec  

Attivare la melodia di suoneria

### Cercare l'unità portatile (funzione di paging)

Avendo perso d'occhio la propria unità portatile è possibile ritrovarla facilmente grazie all'emissione di un tono di ricerca.

presso la base  

Avviare il tono di ricerca

 o  o **OK**

Concludere il tono di ricerca

## 6 Rubrica telefonica/Elenco chiamate

### Rubrica telefonica

Nella rubrica telefonica è possibile memorizzare 100 numeri di chiamata con rispettivi nomi.

Nomi possono avere una lunghezza massima di 12 caratteri, numeri telefonici possono invece essere composti da fino a 24 cifre.

- Assegnare a tutti i numeri di chiamata sempre un prefisso in modo da poter riconoscere anche una chiamata urbana in arrivo ed abbinarla ad una voce presente nella rubrica telefonica.
- Una volta esaurita la capacità di memorizzazione, sul display appare l'indicazione "Memoria piena" non appena si volesse procedere con un'ulteriore immissione. Per poter disporre di nuovo spazio memoria, cancellare prima una voce già presente.
- Le voci della rubrica telefonica sono elencate in ordine alfabetico. Per accedere direttamente alla voce della rubrica telefonica desiderata, premere la lettera iniziale corrispondente.

### Immettere nomi

I tasti numerici riportano altresì delle lettere. Premendo ripetutamente il relativo tasto si ha modo di selezionare lettere e cifre.

<b>0</b>	Immettere spazi vuoti
<b>Canc</b>	Cancellare un carattere
tenere <b>Canc</b>	Cancellare tutti i caratteri



Per immettere la stessa lettera una seconda volta, premere la rispettiva lettera. Attendere fino a quando il cursore si sia spostato di una posizione. Immettere quindi la lettera una seconda volta.

### Elenco chiamate

All'interno dell'elenco chiamate è possibile memorizzare in tutto 30 numeri telefonici.



La visualizzazione del numero di chiamata (**CLIP<sup>1</sup>**) è un servizio aggiuntivo del proprio gestore di rete telefonica. Nel caso in cui il gestore della rete telefonica supporti il servizio, sul display del telefono è visualizzato il numero di chiamata. Per maggiori dettagli a riguardo, rivolgersi al proprio gestore di rete telefonica.

### Visualizzare numeri di chiamata dall'elenco chiamate

, / , **Selez** Aprire l'elenco chiamate e selezionare una voce

### Selezionare un numero di chiamata dall'elenco chiamate e salvarlo nella rubrica telefonica

È possibile memorizzare un numero di chiamata direttamente dall'elenco chiamate nella rubrica telefonica.

, / , **Selez** Aprire l'elenco chiamate e selezionare una voce

**Menu** , /

**Agg a Rubr.** , **Selez** Avviare la procedura di memorizzazione

Immettere il nome e continuare

Modificare se necessario il numero e continuare

/ , **OK** Selezionare e confermare la melodia



Non appena al numero di chiamata nella rubrica telefonica è assegnato un nome, nell'elenco chiamate è visualizzato il nome inserito.

<sup>1</sup> **CLIP:** Calling Line Identification Presentation = Visualizzazione del numero telefonico del chiamante.

## Rubrica telefonica/Elenco chiamate

### Cancellare numeri di chiamata dall'elenco chiamate

Cancellare singoli numeri di chiamata

, / , Selez Aprire l'elenco chiamate e selezionare una voce

Menu , /

Cancella , Selez Attivare la procedura di cancellazione

OK o Indiet Confermare o interrompere la procedura di cancellazione

Cancellare tutti i numeri di chiamata

, Selez Aprire l'elenco chiamate

Menu , /

Cancella tutto , Selez Attivare la procedura di cancellazione

OK o Indiet Confermare o interrompere la procedura di cancellazione

### Elenco ripetizione di chiamata

All'interno dell'elenco ripetizione di chiamata è possibile memorizzare in tutto 20 numeri telefonici.

### Visualizzare i numeri di chiamata dall'elenco ripetizione di chiamata

, / , Selez Aprire l'elenco ripetizione di chiamata e selezionare una voce

### Salvare un numero di chiamata dall'elenco ripetizione di chiamata

È possibile memorizzare un numero di chiamata direttamente dall'elenco ripetizione di chiamata nella rubrica telefonica.

, / , Selez Aprire l'elenco ripetizione di chiamata e selezionare una voce

Menu , /

Agg a Rubr. , Selez Avviare la procedura di memorizzazione

, Immettere il nome e continuare

, Modificare se necessario il numero e continuare

/ , OK Selezionare e confermare la melodia

### Cancellare numeri di chiamata dall'elenco ripetizione di chiamata

Cancellare singoli numeri di chiamata

, / , Selez Aprire l'elenco ripetizione di chiamata e selezionare una voce

Menu , /

Cancella , Selez Attivare la procedura di cancellazione

OK o Indiet Confermare o interrompere la procedura di cancellazione

Cancellare tutti i numeri di chiamata

, Selez Aprire l'elenco di ripetizione di chiamata

Menu , /

Cancella tutto , Selez Attivare la procedura di cancellazione

OK o Indiet Confermare o interrompere la procedura di cancellazione

## 7 Impianti telefonici interni / Servizi aggiuntivi

### Tasto R in impianti telefonici interni

Avendo collegato il telefono ad un impianto telefonico interno, il **tasto R** consente di accedere a tutte le altre funzioni disponibili come per es. trasferimento di chiamata e funzione di richiamata automatica. Si prega di consultare le istruzioni per l'uso del proprio impianto telefonico interno per individuare il tempo flash da impostare al fine di poter usufruire di queste funzioni. Il rivenditore autorizzato è in grado di indicare se il telefono acquistato funzionerà senza alcun problema nel proprio impianto telefonico interno. Il tempo flash è impostato nel menu. A pagina 57 è indicata la posizione da scorrere nel menu.

### Inserire manualmente la pausa di selezione

L'immissione di una pausa di selezione dopo la cifra per il segnale dalla centrale è eseguibile manualmente e consente di proseguire la selezione del numero senza dover attendere il segnale di libero.

2 sec.  Immettere una pausa di selezione

Dopo la cifra per il segnale dalla centrale si procede, trascorso un determinato intervallo di tempo, con la selezione del numero di chiamata vero e proprio.

 La pausa di selezione è memorizzabile anche in sede di immissione di numeri di chiamata nella rubrica telefonica.

### Tasto R e servizi aggiuntivi

Il telefono supporta servizi aggiuntivi messi a disposizione dal proprio gestore di rete telefonica come per es. le funzioni di chiamata in attesa, avviso di chiamata e chiamata a conferenza. Il **tasto R** consente di accedere a questi servizi aggiuntivi. Si prega di consultare il proprio gestore di rete telefonica per ottenere informazioni sul tempo flash necessario all'utilizzo dei servizi aggiuntivi. Rivolgersi al proprio gestore di rete telefonica per ottenere l'abilitazione ai servizi aggiuntivi. Il tempo flash è impostato nel menu. A pagina 57 è indicata la posizione da scorrere nel menu.

### Visualizzazione del numero di chiamata (CLIP<sup>1</sup>)



La visualizzazione del numero di chiamata è un servizio aggiuntivo offerto dal proprio gestore di rete telefonica. Si consiglia di rivolgersi al proprio gestore di rete telefonica per ricevere maggiori informazioni a riguardo.

A condizione che il collegamento telefonico disponga di questa funzione, l'apparecchio visualizza il numero telefonico del chiamante non appena il telefono squilla. Nel caso in cui il chiamante abbia soppresso la trasmissione del proprio numero di chiamata, appare un'apposita indicazione. Se il numero di chiamata non è visualizzabile, questo non sarà memorizzato nell'elenco chiamate.

### Segreteria telefonica integrata nella rete telefonica

Sono numerosi i gestori di rete telefonica che offrono come servizio aggiuntivo una segreteria telefonica integrata nella stessa rete. Se il proprio gestore di rete telefonica mette a disposizione una segreteria telefonica all'interno della propria rete telefonica, un simbolo informa sulla presenza di nuovi messaggi (VMWI<sup>2</sup>). Questa funzione è disponibile solo nel caso di abilitazione al servizio da parte del gestore di rete telefonica. Per maggiori dettagli a riguardo, rivolgersi al proprio gestore di rete telefonica.

<sup>1</sup> **CLIP:** Calling Line Identification Presentation = Visualizzazione del numero telefonico del chiamante.

<sup>2</sup> **VMWI:** Visual Message Waiting Indication = Segnalazione ottica di nuovi messaggi.

# Struttura di menu

## 8 Struttura di menu

### Menu principale

Nel menu principale si giunge premendo il tasto softkey **Menu**. La procedura da seguire per scorrere all'interno del menu ed eseguire immissioni è riportata a pagina 49.

#### Lista Chiam

Selezionare una voce	<b>Menu</b>	Agg a Rubr.	Nome:	
			Numero	
			Melodi	Mel 1-15
		Cancella	OK/Indiet	
		Cancella tutto	OK/Indiet	

#### Rubrica

Visua.	Selezionare una voce	<b>Menu</b>	Modifica
			Cancella
Aggiungi	Nome:		
	Numero		
	Melodi	Mel 1-15	
Modifica	Nome:		
	Numero		
	Melodi	Mel 1-15	
Cancella	Selezionare una voce	OK/Indiet	
Cancella tutto	OK/Indiet		
Stato Rubr			
Copia rubrica	Microtel 1-6		

### Oro/Alarme

Data e ora	Formato data	DD-MM-YYYY
		MM-DD-YYYY
	Formato Ora	12 ore
		24 ore
	Imposta Data	
	Imposta Ora	(▲) / (▼) AM/PM
Sveglia	Sveglia NO	
	Sveglia SI	(▲) / (▼) AM/PM
	Melodia sveglia	Melodia 1
		Melodia 2
		Melodia 3



## Imposta PT

Imposta Audio	Volume altoparl	1-5	
	Volume auric	1-5	
Imposta Suoneria	Suoneria Interno	Melodi 1-15	
	Suoneria esterna	Melodi 1-15	
	Suoneria Vol.	Off, 1-5	
Imposta Toni	Toni Tasti	Off/On	
	Batt sca- rica	Off/On	
	Fuori por- tata	Off/On	
	Lingua	Deutsch	
	Français		
	Italiano		
	English		
	Rinomina PT		
Contrasto	Livello 1-5		
Risp. Auto	Off/On		
Blocco Chiam.	PIN:	Blocco Off/On	
Num. Emergenza	PIN:	Bloc. Numeri	Numero 1-4
		Numero1	
		Numero2	
		Numero3	
Selezione Base	Base		
Reset PT	PIN:	OK/Indiet	

## Imposta base

Cancella PT	PIN:	Microtel 1-6
Modo Composiz	Toni/Decadica	
Tempo flash	Breve/Mezzo/Lungo	
Cambia PIN	PIN:	
	Nv PIN:	
	Confer:	
Primo squillo	Off/On	
Reset imp predef	PIN:	OK/Indiet

## Registraz

Base	PIN:
Base	PIN:
Base	PIN:
Base	PIN:

# Funzioni speciali

## 9 Funzioni speciali

### Procedura di selezione

Il presente telefono funziona sia all'interno di sistemi telefonici analogici (procedura di selezione a impulsi) sia se integrato in moderni sistemi telefonici digitali (procedura di selezione a toni). La procedura di selezione è impostata nel menu. A pagina 57 è indicata la posizione da scorrere nel menu.

### Selezione a toni temporanea

Qualora fosse possibile utilizzare il telefono soltanto con la procedura di selezione a impulsi, non sarà necessario rinunciare ai vantaggi della procedura di selezione a toni (ad es. per l'interrogazione della segreteria telefonica dalla rete telefonica). Con chiamata in corso è possibile passare temporaneamente alla procedura di selezione a toni.



Premere con chiamata in corso

A conclusione della chiamata il telefono passa di nuovo automaticamente alla procedura di selezione a impulsi.

### Allarme

Con la funzione è possibile ricevere un allarme dalla propria unità portatile ad un orario precedentemente impostato. A pagina 56 è indicata la posizione da scorrere nel menu.

### Blocco di numeri di chiamata

Il blocco di numeri di chiamata impedisce a unità portatili di selezionare determinati numeri di chiamata precedentemente memorizzati. L'apparecchio consente la memorizzazione di 4 numeri di chiamata da bloccare composti da rispettivamente 4 cifre. A pagina 57 è indicata la posizione da scorrere nel menu.

### Numeri SOS

È possibile memorizzare fino a 3 numeri di chiamata selezionabili nonostante l'attivazione del blocco di numeri di chiamata. A pagina 57 è indicata la posizione da scorrere nel menu.

### ESEMPIO

Come numero di blocco risulta impostato "017". Tutti i numeri di chiamata che incominciano per "017" sono bloccati (0170 - 0179). Come numero SOS risulta memorizzato "0173". Ciò consente nonostante l'attivazione del

blocco di numeri di chiamata, la selezione di numeri che incominciano per "0173".

### Primo squillo

Selezionando per la funzione "Off" i dati CLIP delle chiamate in arrivo sono visualizzati al primo squillo avvertito acusticamente. Si rimanda alla pagina 57 dove è indicata la posizione "Primo squillo" nel menu.

### Copiare la rubrica telefonica

La funzione consente di copiare la rubrica telefonica da un'unità portatile su un'altra unità portatile. Essa è disponibile in presenza di un maggior numero di unità portatili registrate presso la base.

Menu	Aprire il menu	
▲ / ▼ Rubrica	Selez	Selezionare la rubrica telefonica, confermare
▲ / ▼ Copia rubrica	Selez	Selezionare Copia rubrica, confermare
▲ / ▼ Selez	Selez	Selezionare e confermare l'unità portatile
OK / Canc		Confermare o annullare la procedura presso l'unità portatile ricevente

## 10 Ampliamento del sistema telefonico

Lo standard internazionale **GAP**<sup>1</sup> regola la compatibilità di unità portatili e stazioni base di costruttori differenti. In tal modo è possibile adoperare apparecchi SWITEL in combinazione con apparecchi di altri costruttori all'interno di un unico sistema telefonico. Può comunque anche verificarsi la mancata disponibilità di alcune funzioni.

### Maggior numero di unità portatili



È possibile registrare complessivamente fino a 6 unità portatili presso la propria stazione base.

#### Registrazione di unità portatili

Prima di registrare un'unità portatile, passare con la stazione base alla modalità di registrazione.

tenere 

La modalità di registrazione è avviata

Procedere a questo punto con la registrazione dell'unità portatile  pagina 57. Utilizzare per la registrazione il codice PIN attualmente impostato  pagina 57.

Una volta eseguita la selezione, all'unità portatile è assegnato un numero di chiamata interno. Questo numero di chiamata interno è visualizzato sul display.



Per registrare unità portatili di altri costruttori, leggere prima le rispettive istruzioni per l'uso.

#### Deregistrazione di unità portatili



La deregistrazione di un'unità portatile da una stazione base è possibile solo attraverso un'altra unità portatile registrata a sua volta alla stazione base in questione.

Unità portatili sono deregistrate nel menu. A pagina 57 è indicata la posizione da scorrere nel menu.

### Maggior numero di stazioni base

La portata della propria unità portatile può essere aumentata registrando l'apparecchio ad un numero maggiore di stazioni base. È possibile registrarsi contemporaneamente presso 4 stazioni base differenti. Ogni stazione base necessita di una propria presa telefonica. Si può trattare di allacciamenti con lo stesso o differente numero di chiamata.

Selezione della base  pagina 57.



Per chiamate in corso non è invece possibile compiere un trasferimento da una stazione base all'altra.

<sup>1</sup> **GAP: Generic Access Profile** = Standard per l'interazione di unità portatili e stazioni base di altri costruttori differenti.

# In presenza di problemi

## 11 In presenza di problemi

### Hotline di assistenza

In presenza di problemi con il telefono, seguire le indicazioni riportate qui di seguito. In caso di problemi tecnici è possibile rivolgersi alla nostra hotline di assistenza tecnica chiamando al numero 0900 00 1675 valido per la Svizzera (spese da rete Swisscom alla data di stampa: CHF 2.00 / min). In caso di reclami entro il periodo di garanzia, rivolgersi al rivenditore autorizzato. Il periodo di garanzia ricopre 2 anni.

### Domande e risposte

Domande	Risposte
Non è possibile instaurare un collegamento con la stazione base	- Verificare se la registrazione alla stazione base è stata eseguita con il codice PIN corretto ☞ pagina 57.
Non è possibile condurre una chiamata telefonica	- Il telefono non è collegato correttamente oppure presenta un guasto. Utilizzare esclusivamente il cavo di collegamento telefonico fornito. - Provare con un altro telefono se l'allacciamento telefonico in questione è funzionante. - L'alimentatore di rete non è inserito oppure si è in presenza di una caduta di tensione totale. - Le batterie sono scariche o difettose. - La distanza dalla stazione base è troppo grande. - Procedura di selezione non impostata correttamente ☞ pagina 57.
Collegamento disturbato, interrotto	- La distanza dalla stazione base è troppo grande. - Luogo di installazione della stazione base errato.

Il sistema non reagisce più.	- Ripristinare la configurazione iniziale per tutte le funzioni ☞ pagina 57. - Estrarre brevemente l'alimentatore di rete dalla presa di corrente.
Le batterie ricaricabili si scaricano piuttosto subito.	- Le batterie sono scariche o difettose. - Riporre l'unità portatile correttamente nella stazione base. Pulire le superfici di contatto su unità portatile e stazione base con un panno morbido e asciutto. - Posizionare l'unità portatile per la durata di 14 ore nella stazione base.
La visualizzazione del numero di chiamata (CLIP <sup>1</sup> ) non funziona	- La visualizzazione del numero di chiamata è un servizio aggiuntivo offerto dal proprio gestore di rete telefonica. Per maggiori dettagli a riguardo, rivolgersi al proprio gestore di rete telefonica. - Il chiamante ha disattivato la trasmissione del proprio numero di chiamata.

<sup>1</sup> **CLIP:** Calling Line Identification Presentation = Visualizzazione del numero telefonico del chiamante.

## 12 Specifiche tecniche

### Specifiche tecniche

Caratteristica	Valore
Standard	<b>DECT<sup>1</sup>-GAP<sup>2</sup></b>
Alimentazione elettrica (stazione base)	Ingresso: 230 V <sub>CA</sub> , 50 Hz Uscita: 6 V <sub>CC</sub> , 300 mA
Alimentazione elettrica (stazione di carica)	Ingresso: 230 V <sub>CA</sub> , 50 Hz Uscita: 6 V <sub>CC</sub> , 200 mA
Portata	Esterno: ca. 300 m Interno: ca. 50 m
Stand-by	fino a 100 ore
Max. durata di conversazione	fino a 10 ore
Batterie ricaricabili	2 x AAA NiMH 1,2 V
Procedura di selezione	Toni (DTMF) Decadica (Impulsi)
Temperatura ambiente ammessa	da 10 °C a 30 °C
Umidità dell'aria relativa ammessa	da 20% a 75%
Funzione flash	Breve, Mezzo, Lungo

<sup>1</sup> **DECT**: Digital Enhanced Cordless Telecommunication = Standard per telefoni senza cavo.

<sup>2</sup> **GAP**: Generic Access Profile = Standard per l'interazione di unità portatili e stazioni base di altri costruttori differenti.

### Configurazione iniziale

#### Unità portatile

La configurazione iniziale è ripristinata nel menu. A pagina 57 è indicata la posizione da scorrere nel menu.

Suoneria Vol.	Livello 5	Volume auric	Livello 3
Suoneria esterna	Melodia 2	Volume altoparl	Livello 3
Suoneria Interno	Melodia 1	Contrasto	Livello 3
Toni Tasti	On	Fuori portata	On
Batt scarica	On	Primo squillo	On
Nome:	DF 821	Lingua	Deutsch

#### Stazione base

La configurazione iniziale è ripristinata nel menu.  
A pagina 57 è indicata la posizione da scorrere nel menu.

Modo Composiz	Toni	PIN:	0000
Tempo flash	Breve	Risp. Auto	On
Suoneria Mel.	Melodia 1	Suoneria Vol.	Livello 5

### Dichiarazione di conformità

Questo apparecchio risponde a quanto disposto dalla Direttiva UE:

1999/5/CE Direttiva concernente le apparecchiature radio, le apparecchiature terminali di telecomunicazioni e il reciproco riconoscimento della loro conformità. La conformità con la Direttiva di cui sopra viene confermata dal marchio CE applicato sull'apparecchio.

Per la dichiarazione di conformità completa si prega di voler usufruire del servizio gratuito di download dal nostro sito Internet [www.switel.com](http://www.switel.com).



### 13 Consigli per la cura / Garanzia

#### Consigli per la cura

- Pulire le superfici degli apparecchi con un panno morbido e antipilling.
- Non utilizzare mai detergenti o solventi.

#### Garanzia

Gli apparecchi SWITEL sono costruiti e collaudati in osservanza dei processi di produzione più moderni. L'impiego di materiali selezionati e tecnologie altamente sviluppate sono garanti di una perfetta funzionalità e lunga durata in vita. La garanzia non viene considerata esecutiva qualora la causa del malfunzionamento dell'apparecchio è dovuta al gestore della rete telefonica oppure se questa è da attribuirsi ad un impianto telefonico interno interposto. La garanzia non si estende a batterie, accumulatori o batterie ricaricabili utilizzati all'interno degli apparecchi. Il periodo di garanzia ricopre 24 mesi a partire dalla data di acquisto.

Entro il periodo di garanzia si procederà all'eliminazione gratuita di tutti i guasti dovuti a difetti di materiale o produzione. Il diritto di garanzia cessa in caso di interventi da parte dell'acquirente o di terzi. Danni derivanti da un impiego o esercizio non conforme agli usi previsti, a naturale usura, a errato montaggio o errata conservazione, a collegamento o installazione impropri, dovuti a forza maggiore o ad altri influssi esterni non sono coperti da garanzia. In qualità di produttore ci riserviamo il diritto, in caso di reclami, di riparare o sostituire le parti difettose o di rimpiazzare l'apparecchio. Parti o apparecchi sostituiti passano di nostra proprietà. Sono esclusi diritti di risarcimento per danni qualora non siano dovuti a intenzione o colpa grave del costruttore.

Nel caso in cui il presente apparecchio dovesse ciò nonostante presentare un difetto durante il periodo di garanzia, si prega di rivolgersi esclusivamente al negozio di rivendita dell'apparecchio SWITEL assieme al relativo scontrino di acquisto. In base alle presenti disposizioni, tutti i diritti di garanzia dovranno essere fatti valere esclusivamente nei confronti del rivenditore autorizzato. Decorso il termine di due anni dalla data di acquisto e consegna dei nostri prodotti non sarà più possibile fare valere alcun diritto di garanzia.

## 14 Indice alfabetico

### A

Accettazione di chiamata, 46, 51  
 Agganciare il ricevitore, 51  
 Allarme, 58  
 Ampliamento, 59  
 Attivare, 51

### B

Blocco di numeri di chiamata, 58  
 Blocco tastiera, 52

### C

Cancellare, 54  
 Caricare, 46  
 Cercare, 52  
 Chiamata in attesa, 52  
 Chiamate a conferenza, 52  
 Chiamate interne, 51  
 CLIP, 55  
 Compiere telefonate, 51  
 Concludere una chiamata, 51  
 Configurazione iniziale, 61  
 Consigli per la cura, 62  
 Contenuto della confezione, 45  
 Copiare voci della rubrica telefonica, 58  
 Creare, 50

### D

Data, 46  
 Deregistrare, 59  
 Dichiarazione di conformità, 61  
 Disattivare, 51  
 Display, 48  
 Domande e risposte, 60  
 Durata di conversazione, 52

### E

Elementi di comando, 47  
 Elenco chiamate, 53  
 Elenco ripetizione di chiamata, 54  
 Eliminare guasti, 60  
 Esercizio, 48

### F

Funzione di richiamata, 51  
 Funzione vivavoce, 52  
 Funzioni, 58

### G

Garanzia, 62

### H

Hotline di assistenza, 60

### I

Immissione di un nome, 53  
 Immissione di un testo, 53  
 Impianti telefonici interni, 55  
 Indicazioni di sicurezza, 44  
 Inserire gli accumulatori, 46  
 Inserire manualmente la pausa di selezione, 55

### L

Lingua di display, 46

### M

Melodia di suoneria, 52  
 Menu principale, 56  
 Messa in funzione, 45  
 Modalità di risparmio energetico, 49  
 Modalità di stand-by, 49  
 Modalità ECO, 46  
 Modi di scrittura, 48

### N

Numeri SOS, 58

### O

Ora, 46

### P

Paging, 52  
 Primo squillo, 58  
 Problemi, 60  
 Procedura di selezione, 58  
 Procedura di selezione a impulsi, 58  
 Procedura di selezione a toni, 58

### R

Registrare, 59  
 Riduzione delle radiazioni, 46  
 Ripetizione di chiamata, 51, 54  
 Riscontro, 52  
 Rubrica telefonica, 51, 53

### S

Salvare, 50, 53, 54  
 Segreteria telefonica integrata nella rete telefonica, 55  
 Selezionare, 51  
 Selezione a toni temporanea, 58  
 Servizi addizionali, 55  
 Silenziamento, 52  
 Silenziamento del microfono, 52  
 Simboli, 48  
 Simboli sul display, 48  
 Sollevare il ricevitore, 51  
 Specifiche tecniche, 61  
 Stato di carica delle batterie ricaricabili, 46  
 Stazione base, 45, 59  
 Stazione di carica, 46  
 Struttura di menu, 56

### T

Tasti di navigazione, 49  
 Tasto R, 55  
 Trasferimento di chiamata, 51

### U

Unità portatile, 59

### V

Visualizzazione del numero di chiamata, 53, 55  
 VMWI, 55  
 Voci della rubrica telefonica, 50  
 Volume del ricevitore, 52





- 1 Safety Information . . . . . 66
- 2 Putting the Telephone into Operation . . . 67
- 3 Operating Elements . . . . . 69
- 4 Preliminary Information . . . . . 70
- 5 Telephoning . . . . . 72
- 6 Phone Book/Call List . . . . . 74
- 7 PBX / Supplementary Services . . . . . 76
- 8 Menu Structure . . . . . 77
- 9 Special Functions . . . . . 79
- 10 Extending the Telephone System . . . . . 80
- 11 In Case of Problems . . . . . 81
- 12 Technical Properties . . . . . 82
- 13 Maintenance / Guarantee . . . . . 83
- 14 Index . . . . . 84

# Safety Information

## 1 Safety Information

Please read this operating instruction manual thoroughly.

### Intended use

The telephone is suitable for telephoning within a public telephone network system. Any other use is considered unintended use. Unauthorised modification or reconstruction is not permitted. Under no circumstances open the device or complete any repair work yourself.

### Installation location

Prevent excessive exposure to smoke, dust, vibration, chemicals, moisture, heat and direct sunlight.

Do not use the handset in potentially explosive areas.

### Power adapter plug



**Attention:** Only use the power adapter plug supplied because other power supplies could damage the telephone. Ensure access to the power adapter plug is not obstructed by furniture or such.

### Rechargeable batteries



**Attention:** Never throw batteries into a fire. Only use batteries of the same type. Pay attention to correct polarity. Incorrect polarity of the batteries represents a risk of explosion during charging.

### Power failure

The telephone cannot be used to make calls in the event of a power failure. Always keep a cord connected telephone which operates without an external power supply available in case of emergency situations.

### Medical equipment



**Attention:** Never use the telephone in the vicinity of medical equipment. Effects on such equipment cannot be fully ruled out.

DECT<sup>1</sup> telephones can cause an unpleasant humming sound in hearing aids.

## Disposal

In order to dispose of your device, take it to a collection point provided by your local public waste authorities (e.g. recycling centre). The adjacent symbol indicates that the device must not be disposed of in normal domestic waste! According to laws on the disposal of electronic and electrical devices, owners are obliged to dispose of old **electronic and electrical devices** in a separate waste container.



**Batteries** must be disposed of at the point of sale or at the appropriate collection points provided by the public waste authorities.



**Packaging material** must be disposed of according to local regulations.

<sup>1</sup> **DECT:** Digital Enhanced Cordless Telecommunication = Standard for cordless telephones.

## 2 Putting the Telephone into Operation

### Safety information



**Attention:** It is essential to read the Safety Information in Chapter 1 before starting up.

### Checking the package contents

The package contains:

Content	DF 82x model			
	821	822 <sup>1</sup>	823 <sup>1</sup>	824 <sup>1</sup>
Base station with power adapter plug	1	1	1	1
Charging station with power adapter plug	-	1	2	3
Handsets	1	2	3	4
Telephone connection cable	1	1	1	1
Batteries	2	4	6	8
Operating instructions	1	1	1	1

<sup>1</sup> Visit [www.switel.com](http://www.switel.com) to find out whether the telephone set is already available.

### Connecting the base station



**Attention:** Position the base station at least 1 m away from other electronic devices, otherwise there is a risk of mutual disturbance.

Connect the base station as illustrated in the diagram. For reasons of safety, only use the power adapter plug and telephone connection line supplied.

Telephone line socket

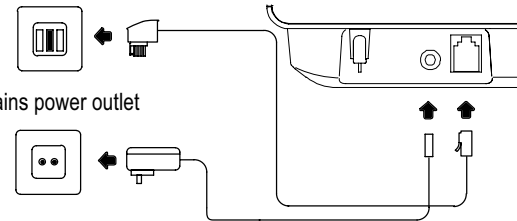

**Attention:** For the base station: use power adapter plug model no. SY-06030-GS, output data: 6 V<sub>DC</sub>, 300 mA.

### Connecting the charging station <sup>2</sup>

Connect the charging station as illustrated in the diagram. For safety reasons, only use the power adapter plug supplied.

Mains power outlet

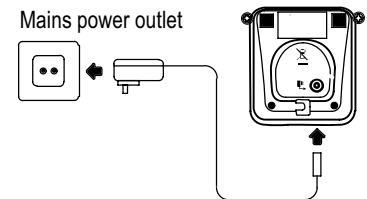

**Attention:** For the charging station: use power adapter plug model no. SY-06020-GS, output data: 6 V<sub>DC</sub>, 200 mA.

<sup>2</sup> Only applies to telephone sets with at least two handsets, "Checking the package contents" on Page 67.

# Putting the Telephone into Operation

## Inserting the batteries

Open the battery compartment cover. Insert the batteries in the battery compartment. Only use the batteries supplied. Close the battery compartment cover.

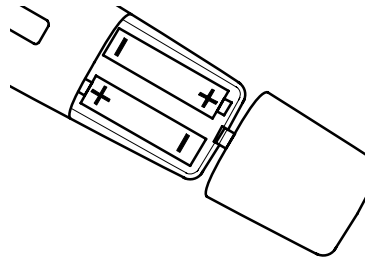

## Charging the batteries



Before the handset is used for the first time, insert it in the base station / charging station for **at least** 14 hours.

The handset warms up during the charging process. This is normal and does not represent a risk. Do not charge the handset with charging units from other manufacturers. The current **battery charge status** is indicated in the display:



Full



Half empty



Low



Empty

## Setting the time and date on the handset

The time and date are set via the menu.  
Refer to Page 77 for the sequence of menu option selections.

## Setting the display language

The display language is available in German, English, Italian and French.  
Set the language using the menu.  
Refer to Page 78 for the sequence of menu option selections.

## Automatic answering

If this function is activated, an incoming call is taken when the handset is removed from the base station. The automatic answering function is activated and deactivated using the menu.  
Refer to Page 78 for the "Auto Answer" menu option.

## Low-radiation operation (ECO mode)













In Call mode, the handset radiation is reduced considerably as compared to standard, cordless DECT telephones.

## 3 Operating Elements

The buttons in this operating manual are subsequently depicted with a uniform contour. Therefore, slight deviations in the appearance of the symbols on the telephone buttons compared to those depicted here are possible.

### Handset

- 1 Earpiece
- 2 Display
- 3 INT button 
- 4 Softkey, right
- 5 Handsfree 
- 6 Scroll up 
- 7 Scroll right  / Call list 
- 8 On-hook button  
Standby mode 
- 9 Digit keys
- 10 # button / Ringing tone off
- 11 Microphone
- 12 \* button / Key lock /  
Temporary tone dialling
- 13 Call button (off-hook) 
- 14 Scroll down  /  
Redialling 
- 15 Scroll left 
- 16 R-button (Flash) 
- 17 Softkey, left
- 18 Loudspeaker  
(rear of the handset)

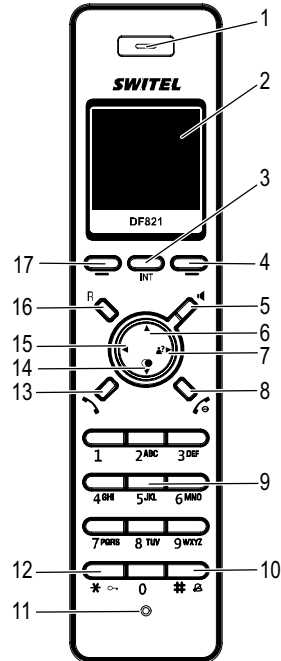

### Base station

- 1 Charge contacts
- 2 Locate handset (paging) 

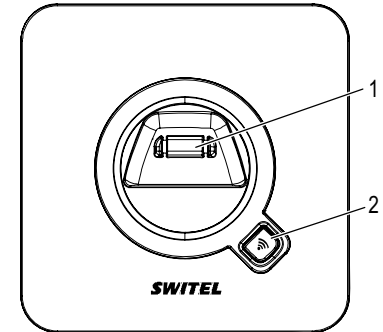













# Preliminary Information











## 4 Preliminary Information

This chapter provides basic information on using the operating instruction manual and the telephone.

### Description of operating sequences in the manual

Display	Description
	Displays the contour of buttons
	Press the button depicted briefly
2 sec. 	Press the button depicted for 2 seconds
Hold 	Press and hold down the button depicted
Release 	Release the button depicted
	Enter digits or letters
	Handset rings
	Base station rings
	Remove the handset from the base station
	Place the handset in the base station
	Depicts text in the display
	Depicts icons in the display
	Press the softkey, <a href="#">Page 69</a>

### Icons and texts in the handset display

Icon	Description
	On: Indicates the battery charge status. Run-through segments: The batteries are being charged, <a href="#">Page 68</a> .
	On: The alarm function is activated. Flashing: The alarm is ringing.
dd/mm hh:mm	Display of date and time, <a href="#">Page 77</a> .
	On: A call is currently being made. New entries in the call list. Flashing: A call has been received, <a href="#">Page 72</a> .
	The answering machine provided in your telephone network has recorded new messages ( <b>VMWI</b> <sup>1</sup> ). Supplementary service offered by telephone network providers, <a href="#">Page 76</a> .
	The ringing tone has been switched off, <a href="#">Page 73</a> .
	Handsfree mode is activated, <a href="#">Page 73</a> .
	The key lock function is activated, <a href="#">Page 73</a> .
	On: An internal call is currently being made. Flashing: An internal call has been received.
	On: The connection to the base station is good.
	Flashing: The connection to the base station is interrupted. Move nearer to the base station.

<sup>1</sup> **VMWI**: Visual Message Waiting Indication = Visual indicator that new messages have been recorded.

## Standby mode

All descriptions in this operating manual assume that the handset is in Standby mode. The system switches to Standby mode by pressing the  button.

## Energy-save mode

When the handset has been in Standby mode for some time, it automatically switches to energy-save mode. The display no longer lights up. Press any button to reactivate Standby mode.

## Navigation buttons



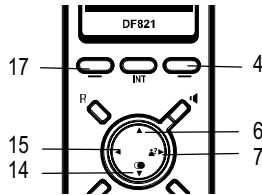





The softkeys (4) and (17) are assigned different functions in the different menus. The function buttons are always referred to in this manual according to the texts directly above them in the display.



Button	In Standby mode	In a menu
4	- Open the phone book	- Move one level back
6		- Scroll through the menu - Change the settings
7	- Open the call list	- Change the settings
14	- Open the redialling list	- Scroll through the menu - Change the settings
15		- Change the settings
17	- Open the main menu	- Open the menu displayed

## Navigating in the menu











All the functions can be accessed via the various menus. Refer to Menu Structure,  Page 77, for information on how to access each function.

<b>Menu</b>	Open the main menu
 / 	Select the submenu required
<b>Select</b>	Open the submenu
 / 	Select the function required
<b>Select</b>	Open the function
 / 	Select the setting required
	Use the digit keys to enter numbers or letters
<b>Select</b>	Confirm the input
<b>Back</b>	Move one level back
	Cancel the programming/saving processes, activate Standby mode

 Every process is automatically cancelled if there is no input within 30 seconds.

## Creating phone book entries - example

Proceed as in this example for all the settings.

<b>Menu</b>	Open the menu
 /  , Phonebook , <b>Select</b>	Select the phone book and confirm
 /  , Add , <b>Select</b>	Select the function and confirm it
 	Enter the name and continue
 	Enter the phone number and continue
 /  , <b>OK</b>	Select the melody and confirm it

 Press and hold the # button for 2 seconds: Switch between upper and lower case.

# Telephoning

## 5 Telephoning

### Taking a call

), or Take the call

### Ending a call

or End the call

### Switching the handset off and on

You can switch the handset off to save the batteries.

3 sec. Switch the handset off

2 sec. Switch the handset on

### Making a call

Enter the phone number (max. 24 digits)

**Clear** Delete the last digit if incorrect

Dial the phone number

It is also possible to press the Call button /Handsfree button first and wait for the dialling tone. The digits then entered are dialled immediately. It is not possible to correct wrong digits individually using this dialling procedure.

### Redialling

The telephone stores the last 20 numbers dialled in a redialling list. For further information, Page 75.

Open the redialling list

or , Select the entry required and dial it

### Calling back calls received

The telephone stores the numbers of the last 30 calls received in a call list, Page 74.

New calls are marked by a \*.

Open the call list

or , Select the entry required and dial it

### Dialling numbers from the phone book

Phone numbers must have been stored in the phone book for this function, Pages 71 and 74.

**PB** Open the phone book

or , Select the entry required and dial it

### Internal calls<sup>1</sup>

#### Making internal calls

There must be two or more handsets (HS1, HS2, ...) registered on your base station in order to make internal calls free of charge.

HS1: **INT**,

or , **Select** Dial the internal call number of the handset required

HS2: Take the internal call on the other handset

HS1/HS2: End the internal call

#### Forwarding external calls internally

HS1: **INT**,

or , **Select** Dial the internal call number during the conversation with the external caller

HS2: Take the internal call on the other handset



HS1: Forward the call

<sup>1</sup> Internal calls are only possible when at least two handsets are registered in the system; "Checking the contents of the package" on Page 67.



## Holding a call / brokering

While a call is in progress, it is possible to dial another handset in order to consult with someone. The external caller is put on hold while you converse with the second, internal person called. You can repeat this procedure as often as required.



HS1: **INT**,  
 or , **Select** Dial the internal call number during the conversation with the external caller

HS2:  Take the internal call on the other handset

HS1: **INT** Switch between callers

## Making conference calls

An external call can be transferred to another internal handset for a conference call.

HS1: **INT**,  
 or , **Select** Dial the internal call number during the conversation with the external caller

HS2:  Take the internal call on the other handset

HS1: hold down **INT** Start the conference

HS1: **INT** Only continue with external caller

HS1/HS2:  End the conference call

## Setting the receiver volume

The volume can be adjusted to one of 5 levels during a call.

 or  Select the volume required

## Displaying the duration of a call

The duration of a call is displayed in hours, minutes and seconds during the call.

## Handsfree mode

This function is used to listen to the caller via the loudspeaker.

 Activate the handsfree facility

 Deactivate the handsfree facility

## Muting the microphone in the handset

The microphone in the handset can be activated and deactivated during a telephone conversation.

**Mute** Deactivate the microphone (muting function activated)

**Unmute** Activate the microphone

## Key lock

The key lock prevents functions assigned to buttons being activated inadvertently.

2 sec.  Activate the key lock function

 Incoming calls can still be taken in the normal way even when the key lock function is activated.

2 sec.  Deactivate the key lock function

## Handset ringing melody

The ringing melody on the handset can be deactivated.

2 sec.  Deactivate the ringing melody

2 sec.  Activate the ringing melody

## Searching for the handset (Paging)

If you have mislaid your handset, you can locate it again with the aid of a search tone.

on the base   Start the search tone

 or  or **OK** Stop the search tone

# Phone Book/Call List

## 6 Phone Book/Call List

### Phone Book

You can use the phone book to store up to 100 phone numbers together with the associated names.

Names can have a maximum of 12 characters and phone numbers a maximum of 24 digits.

- Always enter the area access code with the phone numbers so that incoming local calls can also be assigned to a phone book entry.
- When the memory capacity is used up, the message "Memory Full" appears in the display. To create space, an existing entry must first be deleted.
- The phone book entries are arranged alphabetically. To access the required phone book entry directly, press the first letters of the corresponding name.

### Entering names

Letters are also imprinted on the digit keys. Letters and digits are entered by pressing the relevant key the respective number of times.

<b>0</b>	Enter a space
<b>Clear</b>	Delete a character
Press and hold <b>Clear</b>	Delete all the characters

 To enter the same letter twice, press the button to enter the letter. Wait until the cursor skips one position forwards. Enter the letter again.

### Call List

A total of 30 phone numbers are stored in a call list.



The caller number display (**CLIP**<sup>1</sup>) is a supplementary service offered by your telephone network provider. The caller's number appears in the display if the service is offered by your telephone network provider. Contact your network provider for further information.

### Displaying numbers in the call list

**?#**, **▲** / **▼**, **Select** Open the call list and select the entry

### Storing a phone number in the call list in the phone book

A phone number in the call list can be stored in the phone book directly.

**?#**, **▲** / **▼**, **Select** Open the call list and select the entry

**Menu**, **▲** / **▼**

**Add to PB**, **Select** Start the storing process

 **▼** Enter the name and continue

 **▼** Edit the number, if necessary, and continue





**◀** / **▶**, **OK** Select the melody and confirm it

 As soon as the phone number in the phone book has been saved together with a name, the name entered appears in the call list.



<sup>1</sup> **CLIP**: Calling Line Identification Presentation = Display the caller's phone number.

## Deleting phone numbers from the call list

### Deleting individual phone numbers

 ,  /  , <b>Select</b>	Open the call list and select the entry
<b>Menu</b> ,  / 	
<b>Delete</b> , <b>Select</b>	Activate the deleting process
<b>OK</b> or <b>Back</b>	Confirm the deleting process or cancel it

### Deleting all phone numbers

 , <b>Select</b>	Open the call list
<b>Menu</b> ,  / 	
<b>Delete All</b> , <b>Select</b>	Activate the deleting process
<b>OK</b> or <b>Back</b>	Confirm the deleting process or cancel it

## Redialling List











A total of 20 calls are stored in the redialling list.

### Displaying phone numbers in the redialling list

 ,  /  , <b>Select</b>	Open the redialling list and select the entry required
---	--





### Storing a phone number from the redialling list

A phone number in the redialling list can be stored in the phone book directly.



 ,  /  , <b>Select</b>	Open the redialling list and select the entry required
<b>Menu</b> ,  / 	
<b>Add to PB</b> , <b>Select</b>	Start the storing process
 , 	Enter the name and continue
 , 	Edit the number, if necessary, and continue
 /  , <b>OK</b>	Select the melody and confirm it

## Deleting phone numbers from the redialling list

### Deleting individual phone numbers

 ,  /  , <b>Select</b>	Open the redialling list and select the entry required
<b>Menu</b> ,  / 	
<b>Delete</b> , <b>Select</b>	Activate the deleting process
<b>OK</b> or <b>Back</b>	Confirm the deleting process or cancel it

### Deleting all phone numbers

 , <b>Select</b>	Open the redialling list
<b>Menu</b> ,  / 	
<b>Delete All</b> , <b>Select</b>	Activate the deleting process
<b>OK</b> or <b>Back</b>	Confirm the deleting process or cancel it

## 7 PBX / Supplementary Services

### R-button on private branch exchanges

If the telephone is connected to a private branch exchange, functions such as transferring calls and automatic call back can be used via the **R button**. Refer to the operating manual provided with your private branch exchange as to which Flash time must be set in order to use these functions. The sales outlet where you purchased the exchange can provide information as to whether the telephone will work properly with the exchange. The Flash time is set using the menu. Refer to Page 78 for the sequence of menu option selections.

### Entering a dialling pause manually

It is possible to insert a **dialling pause manually** after the number for an outside line to be able to continue dialling directly without waiting for the dialling tone.

2 sec.  Insert a dialling pause

The actual phone number is dialled a certain time after the number for an outside line.



The dialling pause can also be entered with the phone numbers in the phone book.

### R-button and supplementary services

Your telephone supports supplementary services provided by your telephone network provider, such as brokering, call waiting and conference facilities. These supplementary services can be used by implementing the **R button**. Please contact your telephone network provider regarding which Flash time must be set to use the supplementary services. Contact your telephone network provider with regard to enabling supplementary services. The Flash time is set using the menu. Refer to Page 78 for the sequence of menu option selections.

### Caller number display (CLIP<sup>1</sup>)



The caller number display function is a supplementary service offered by telephone network providers. Contact your network provider for further information.

If this function is available with your telephone line, the number of the caller appears in the display when the phone rings. If the caller has suppressed transmission of his phone number, the corresponding message appears in the display. The phone number is not displayed and, as a result, is not stored in the call list.

### Answering machine in the telephone network

An answering machine in the telephone network is a supplementary service offered by many telephone network providers. If your telephone network provider offers an answering machine in the telephone network for you, you are informed of new messages received by an icon (**VMWI<sup>2</sup>**). This function can only be used when your telephone network provider actually offers the service. Contact your network provider for further information.

<sup>1</sup> **CLIP**: Calling Line Identification Presentation = Display the caller's phone number.

<sup>2</sup> **VMWI**: Visual Message Waiting Indication = Visual indicator that new messages have been recorded.

## 8 Menu Structure

### Main menu

Access the Main menu by pressing the **Menu** softkey. The way to navigate through the menu and make entries and selections are described on Page 71.

#### Call List

Select entry	<b>Menu</b>	Add to PB	Name:
			Number
			Melody Mel 1-15
	Delete	<b>OK/Back</b>	
	Delete All	<b>OK/Back</b>	

#### Phonebook

View	Select entry	<b>Menu</b>	Edit
			Delete
Add	Name:		
	Number		
	Melody Mel 1-15		
Edit	Name:		
	Number		
	Melody Mel 1-15		
Delete	Select entry	<b>OK/Back</b>	
Delete All	<b>OK/Back</b>		
PB Status			
PB Transfer	Handset 1-6		

### Clock/Alarm

Date & Time	Date Format	DD-MM-YYYY
		MM-DD-YYYY
	Time Format	12 Hours
		24 Hours
	Set Date	
	Set Time	(▲) / (▼) AM/PM
Alarm	Alarm Off	
	Alarm On	(▲) / (▼) AM/PM
	Alarm Melody	Melody 1
		Melody 2
		Melody 3

# Menu Structure

## HS Settings

Audio Setup	Speaker Volume	1-5	
	Ear Volume	1-5	
Ring Setup	Internal Ring	Melody 1-15	
	External Ring	Melody 1-15	
	Ring Volume	Off, 1-5	
Tone Setup	Key Tone	Off/On	
	Battery Low	Off/On	
	Out of Range	Off/On	
	Language	Deutsch	
	Français		
	Italiano		
	English		
Rename HS			
Contrast	Level 1-5		
Auto Answer	Off/On		
Call Barring	PIN:	Barring Mode	Off/On
		Barring Number	Number 1-4
SOS Number	PIN:	Number1	
		Number2	
		Number3	
Select Base	Base 1-4		
HS Default	PIN:	OK/Back	

## Base Settings

Delete HS	PIN:	Handset 1-6
Dial Mode	Tone/Pulse	
Flash Time	Short/Medium/Long	
Modify PIN	Old PIN:	
	New PIN:	
	Confirm:	
First Ring	Off/On	
BS Default	PIN:	OK/Back

## Registration

Base	PIN:
Base	PIN:
Base	PIN:
Base	PIN:

## 9 Special Functions

### Dialling mode

The telephone can be operated in analogue exchanges (PULSE mode) as well as new, digital exchanges (TONE/DTMF mode). The dialling mode is controlled via the menu. Refer to Page 78 for the sequence of menu option selections.

### Temporary tone dialling

If you only operate the telephone using the PULSE dialling mode, you can still make use of the advantages of TONE dialling mode (e.g.: remote access of the answering machine in the telephone network). You can temporarily switch to Tone dialling when a connection has already been made.



Press the button during the call

When the call is ended, the equipment automatically switches back to Pulse dialling.

### Alarm

The "Alarm clock" function can be used so that you are alerted by the handset at a specific time. Refer to Page 77 for the sequence of menu option selections.

### Call barring

The call barring function prevents call numbers, which you have programmed, from being dialled. You can define four numbers, each comprised of 4 digits, to be barred. Refer to Page 78 for the sequence of menu option selections.

### SOS numbers

You can store up to 3 phone numbers which can still be dialled even when the call barring function is activated. Refer to Page 78 for the sequence of menu option selections.

### Example

"017" has been programmed in the call barring facility. All phone numbers beginning with "017" are barred (0170 - 0179). "0173" is saved as an SOS number. As a result, it is possible to dial phone numbers which begin with "0173" despite the fact that call barring is activated.

### First ring

If you set this function to "Off", the CLIP data appears in the display at the first audible ring you hear of an incoming call. Refer to Page 78 for the "First Ring" menu option.

### Copying the phone book

The phone book can be copied from one handset to another. This function is only available when more than one handset is registered on the base station.

Menu	Open the menu
▲ / ▼ Phonebook	Select the phone book, confirm
Select	Select PB Transfer and confirm it
▲ / ▼ PB Transfer	Select the handset and confirm
Select	Confirm or cancel the action on the receiving handset
OK / Cancel	

# Extending the Telephone System

## 10 Extending the Telephone System

The internationally approved **GAP**<sup>1</sup> standard regulates the compatibility of handsets and base stations from different manufacturers. As a result, it is possible to integrate SWITEL devices and devices from other manufacturers together in one telephone system. It is possible, however, that some functions are not available.

### Multiple handsets

Up to 6 handsets can be registered on the base station.

#### Registering handsets

Before starting to register a handset, switch the base station to Registration mode.

Press and hold  Activate Registration mode

Now register the handset, [Page 78](#).

The currently valid PIN is used for registration purposes, [Page 78](#).

The handset is automatically assigned an internal call number following registration. The internal call number appears in the display.

 To register handsets from other manufacturers, please refer to the operating manual supplied with them.

#### Deregistering handsets

 A handset can only be deregistered from a base station by using another handset registered to the same base station.

Handsets are deregistered via the menu. Refer to [Page 78](#) for the sequence of menu option selections.

### Multiple base stations

You can increase the range of your handset by registering it on several base stations. The handset can be registered on up to 4 different base stations simultaneously. Each base station requires its own telephone line socket. Connections can be used with the same call number or with different ones.

Refer to [Select Base](#), [Page 78](#).

 Calls in progress cannot be transferred from one base station to another.

<sup>1</sup> **GAP: Generic Access Profile** = Standard for the interoperation of handsets and base stations from different manufacturers.





## 11 In Case of Problems

### Service Hotline

Should problems arise with the telephone, please refer to the following information first. In the case of technical problems, you can contact our hotline service, Tel. 0900 00 1675 within Switzerland (cost via Swisscom at time of going to print: CHF 2.00/min). In the case of claims under the terms of guarantee, contact your sales outlet. There is a 2 year period of guarantee.

### Problems and solutions

Problems	Solutions
No connection to base station possible	<ul style="list-style-type: none"> <li>- Check that the handset has been registered on the base station with the correct PIN code;  Page 78.</li> </ul>
No telephone calls possible	<ul style="list-style-type: none"> <li>- The telephone is not connected properly or is defective. Only use the telephone connection line supplied.</li> <li>- Test whether the telephone connection is in order by using another telephone.</li> <li>- The power adaptor plug is not plugged in or there is a complete power failure.</li> <li>- The batteries are empty or defective.</li> <li>- The handset is too far from the base station.</li> <li>- The wrong dialling mode is set;  Page 78.</li> </ul>
Connection is disturbed or cut off	<ul style="list-style-type: none"> <li>- The handset is too far from the base station.</li> <li>- The base station is in an unsuitable location.</li> </ul>

The system no longer responds	<ul style="list-style-type: none"> <li>- Reset all the functions to their default settings;  Page 78.</li> <li>- Disconnect the power adapter plug briefly from the power socket.</li> </ul>
The batteries are empty within a short time	<ul style="list-style-type: none"> <li>- The batteries are empty or defective.</li> <li>- Place the handset in the base station properly. Clean the contact surfaces on the handset and base station with a soft, dry cloth.</li> <li>- Place the handset in the base station for 14 hours.</li> </ul>
The caller number display (CLIP <sup>1</sup> ) does not function	<ul style="list-style-type: none"> <li>- The caller number display function is a supplementary service offered by telephone network providers. Contact your network provider for further information.</li> <li>- The caller has suppressed the transmission of their phone number.</li> </ul>

<sup>1</sup> **CLIP:** Calling Line Identification Presentation = Display the caller's phone number.

# Technical Properties

## 12 Technical Properties

### Technical data

Feature	Value
Standard	<b>DECT<sup>1</sup>-GAP<sup>2</sup></b>
Power supply (base station)	Input: 230 V <sub>AC</sub> , 50 Hz Output: 6 V <sub>DC</sub> , 300 mA
Power supply (charging station)	Input: 230 V <sub>AC</sub> , 50 Hz Output: 6 V <sub>DC</sub> , 200 mA
Range	Outdoors: Approx. 300 m Indoors: Approx. 50 m
Standby	Up to 100 h
Max. talk time	Up to 10 h
Rechargeable batteries	2 x AAA NiMH 1.2 V
Dialling mode	Tone (DTMF) Pulse
Permissible ambient temperature	10°C to 30°C
Permissible relative humidity	20% to 75%
Flash function	Short, Medium, Long

<sup>1</sup> **DECT**: Digital Enhanced Cordless Telecommunication = Standard for cordless telephones.

<sup>2</sup> **GAP**: Generic Access Profile = Standard for the interoperation of handsets and base stations from different manufacturers.

### Default settings

#### Handset

The default settings can be restored via the menu. Refer to Page 78 for the sequence of menu option selections.

Ring Volume	Level 5	Ear Volume	Level 3
External Ring	Melody 2	Speaker Volume	Level 3
Internal Ring	Melody 1	Contrast	Level 3
Key Tone	On	Out of Range	On
Battery Low	On	First Ring	On
Name:	DF 821	Language	Deutsch

#### Base station

The default settings can be restored via the menu. Refer to Page 78 for the sequence of menu option selections.

Dial Mode	Tone	PIN:	0000
Flash Time	Short	Auto Answer	On
Ring Melody	Melody 1	Ring Volume	Level 5

### Declaration of Conformity

This device fulfils the requirements stipulated in the EU directive:

1999/5/EU directive on radio equipment and telecommunications terminal equipment and the mutual recognition of their conformity. Conformity with the above mentioned directive is confirmed by the CE symbol on the device.

To view the complete Declaration of Conformity, please refer to the free download available on our web site [www.switel.com](http://www.switel.com).



## 13 Maintenance / Guarantee

### Maintenance

- Clean the housing surfaces with a soft, fluff-free cloth.
- Do not use any cleaning agents or solvents.

### Guarantee

SWITEL equipment is produced and tested according to the latest production methods. The implementation of carefully chosen materials and highly developed technologies ensure trouble-free functioning and a long service life. The terms of guarantee do not apply where the cause of equipment malfunction is the fault of the telephone network operator or any interposed private branch extension system. The terms of guarantee do not apply to the batteries or power packs used in the products. The period of guarantee is 24 months from the date of purchase.

All deficiencies related to material or manufacturing errors within the period of guarantee will be redressed free of charge. Rights to claims under the terms of guarantee are annulled following tampering by the purchaser or third parties. Damage caused as the result of improper handling or operation, normal wear and tear, incorrect positioning or storage, improper connection or installation or Acts of God and other external influences are excluded from the terms of guarantee. In the case of complaints, we reserve the right to repair defect parts, replace them or replace the entire device. Replaced parts or devices become our property. Rights to compensation in the case of damage are excluded where there is no evidence of intent or gross negligence by the manufacturer.

If your device does show signs of a defect within the period of guarantee, please contact the sales outlet where you purchased the SWITEL device, producing the purchase receipt as evidence. All claims under the terms of guarantee in accordance with this agreement can only be asserted at the sales outlet. No claims under the terms of guarantee can be asserted after a period of two years from the date of purchase and hand-over of the product.

## 14 Index

### A

Alarm, 79  
Answering machine in the telephone network, 76

### B

Base station, 67, 80  
Battery charge status, 68  
Brokering, 73

### C

Call back, 72  
Call barring, 79  
Call list, 74  
Caller number display, 74, 76  
Charging, 68  
Charging station, 67  
CLIP, 76  
Conference calls, 73  
Copying phone book entries, 79  
Creating, 71

### D

Date, 68  
Declaration of Conformity, 82  
Default settings, 82  
Deleting, 75  
Deregistration, 80  
Dialling, 72  
Dialling mode, 79  
Display, 70  
Display icons, 70  
Display language, 68

### E

ECO mode, 68  
Ending a call, 72  
Energy-save mode, 71  
Entering a dialling pause manually, 76  
Entering names, 74  
Entering text, 74  
Extending, 80

### F

First ring, 79  
Forwarding calls, 72  
Functions, 79

### G

Guarantee, 83

### H

Handset, 80  
Handsfree mode, 73  
Holding a call, 73

### I

Icons, 70  
Inserting the batteries, 68  
Internal calls, 72

### K

Key lock, 73

### L

Low-radiation, 68

### M

Main menu, 77  
Maintenance, 83  
Making a call, 72  
Menu structure, 77  
Muting, 73  
Muting button, 73

### N

Navigation buttons, 71  
Notation, 70

### O

Off-hook, 72  
On-hook, 72  
Operating elements, 69  
Operation, 70

### P

Package contents, 67  
Paging, 73  
Phone book, 72, 74  
Phone book entries, 71  
Private branch exchanges, 76  
Problems, 81  
Problems and solutions, 81  
Pulse dialling mode, 79

### R

R-button, 76  
Receiver volume, 73  
Redialling, 72, 75  
Redialling list, 75  
Registering, 80  
Ringing melody, 73

### S

Safety information, 66  
Saving, 71, 75  
Searching for the handset, 73  
Service-Hotline, 81  
SOS numbers, 79  
Standby mode, 71  
Starting up, 67  
Storing, 74  
Supplementary services, 76  
Switching off, 72  
Switching on, 72

### T

Taking a call, 68, 72  
Talk time, 73  
Technical data, 82  
Telephoning, 72  
Temporary tone dialling, 79  
Time, 68  
Tone dialling mode, 79  
Transferring calls, 72  
Troubleshooting, 81

### V

VMWI, 76



## Notes

---



# **SWITEL**

## **Declaration of conformity**

Diese Anlage entspricht der europäischen R&TTE Richtlinie.

Für die komplette Konformitätserklärung nutzen Sie bitte den kostenlosen Download von unserer Website [www.switel.com](http://www.switel.com).

Cet équipement est conforme à la directive européenne R&TTE.

Pour obtenir la déclaration de conformité intégrale, veuillez vous servir du téléchargement gratuit de notre site Internet [www.switel.com](http://www.switel.com).

Quest'apparecchiatura è conforme alla direttiva europea R&TTE.

Per la dichiarazione di conformità completa si prega di voler usufruire del servizio gratuito di download dal nostro sito Internet [www.switel.com](http://www.switel.com).

This equipment complies with the European R&TTE directive.

To view the complete Declaration of Conformity, please refer to the free download available at our web site: [www.switel.com](http://www.switel.com).

