

space for you

UP cabinet

Istruzioni per il montaggio
Assembly instruction
Montageanleitungen
Instructions pour le montage
Istruccìon para el montaje
Instrucões de montagem
Instruțiuni de montaj
Инструкции за монтаж
Инструкции по монтажу
Instruksione montimi
Unstructies voor de montage
Οδηγίες συναρμολόγησης
Montaj talimatları

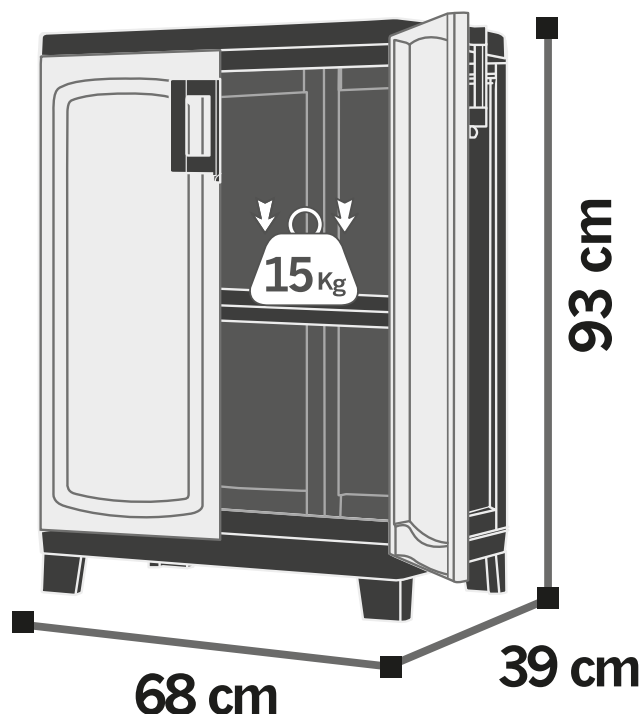

Art. 009852

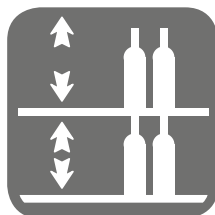

290350_Rev00_07/11

* non incluso/not included/nicht inbegriffen/non incluses/no incluido/nao incluidos/niet inbegrepen/nije uključen/do zestawu/nincsenek mellékelve/bez nardędzi/nu sunt incluse/δεν περιλαμβάνονται/غير مدرج/не включено/Není součástí/følger ikke med/ei kuulu toimitukseen/別売り/ikke inkludert/Niedolączona do opakowania/Não incluido/Nije sadržan/Nie je súčasťou/Ingår inte/не включено до постачання/nincs mellékelve

Made in Italy

www.kis.it

a.b.m. Italia SpA - Via Ing. G. Taliercio 1 - 31024 Roncadelle di Ormelle (TV) - Italia
Tel. +39 0422 745900 - Fax +39 0422 745999 - info@abmitalia.com

Parts

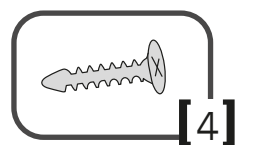
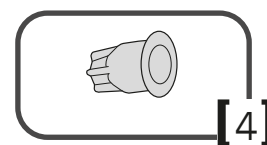
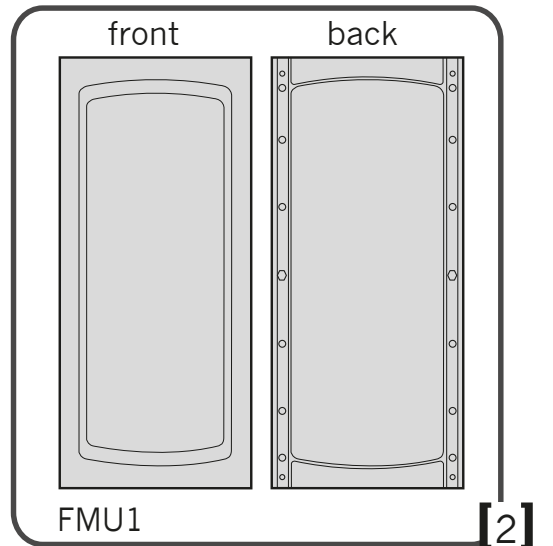
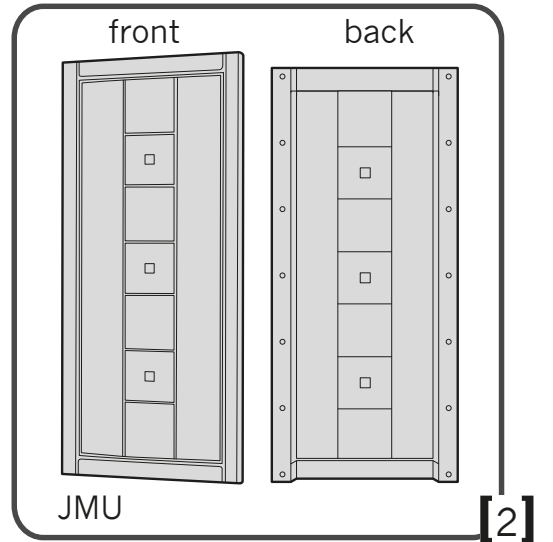
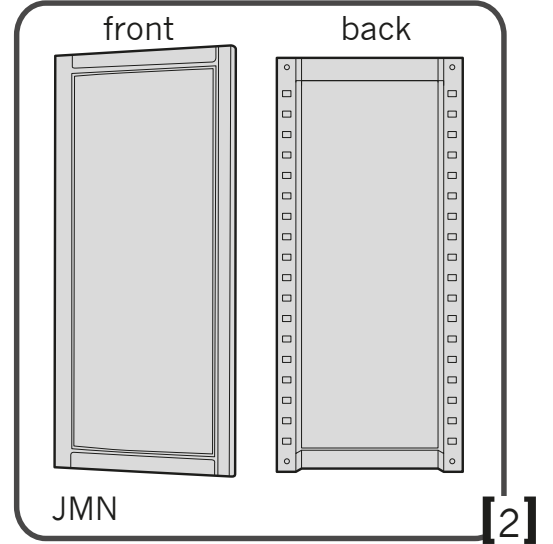
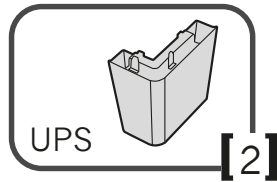
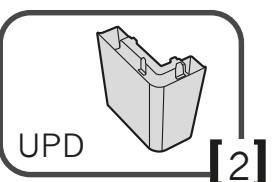
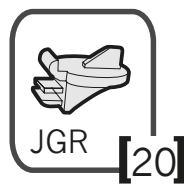
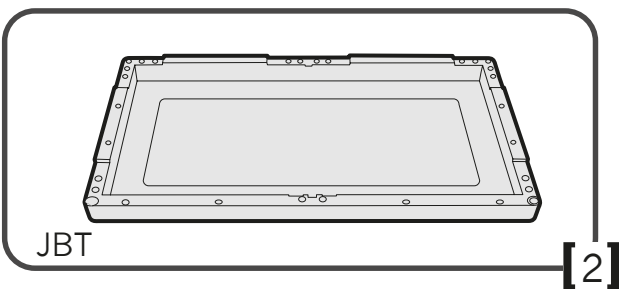
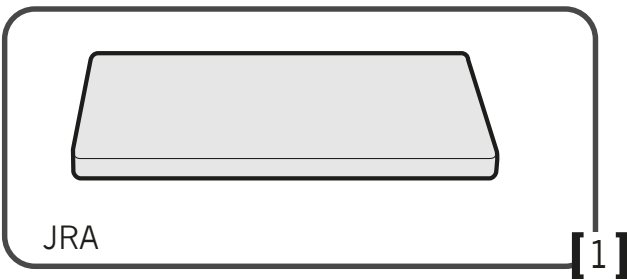
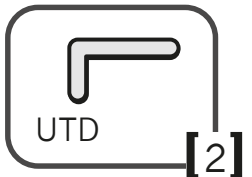
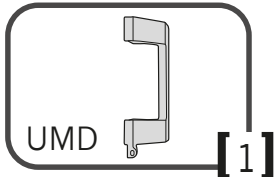
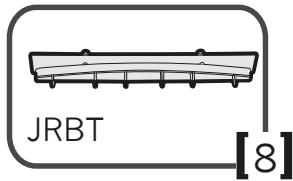
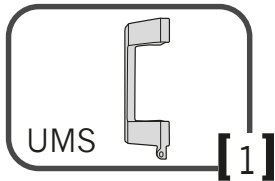
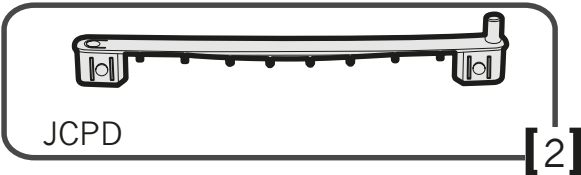
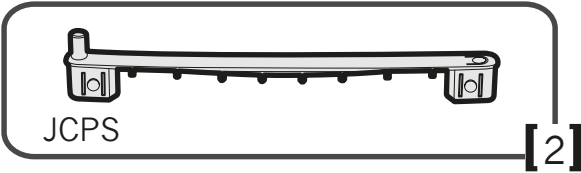
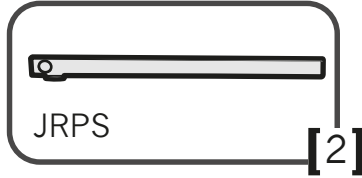
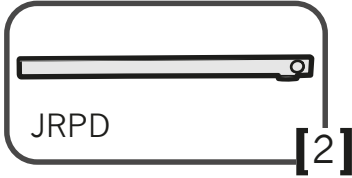
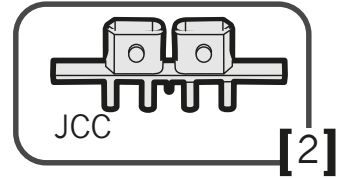
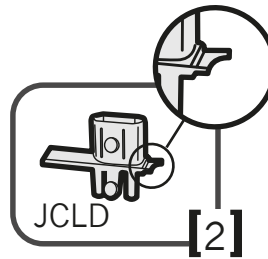
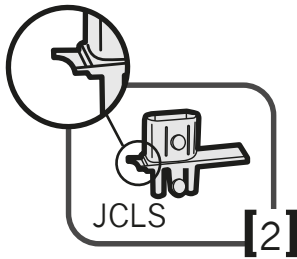
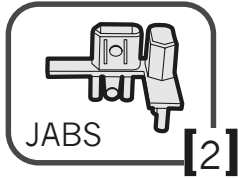
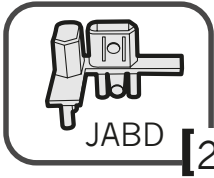

1



JBT



UPD x 2



UPS x 2

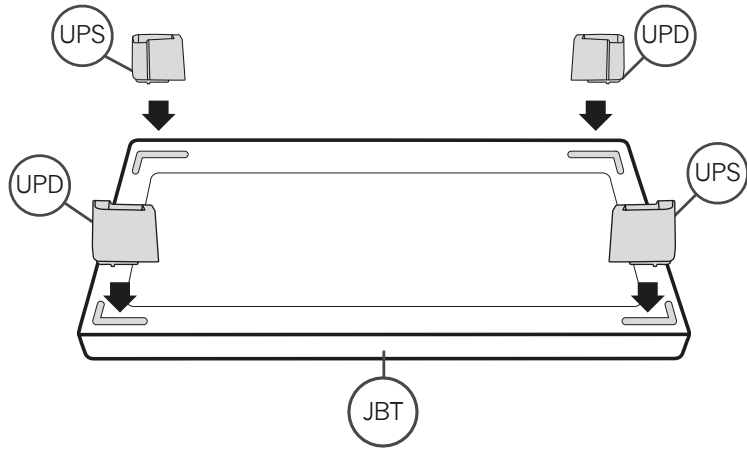

2



JRBT x 4



JRPS x 1



JRPD x 1

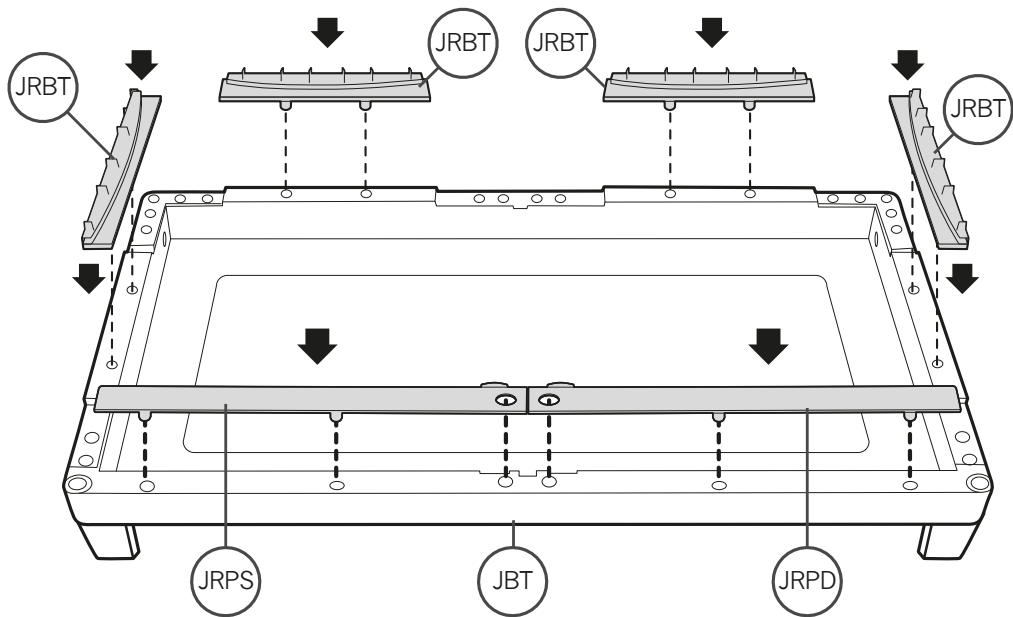

3

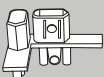

JABD x 1

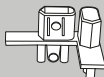

JABS x 1

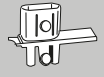

JCLS x 1

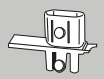

JCLD x 1



JCC x 1

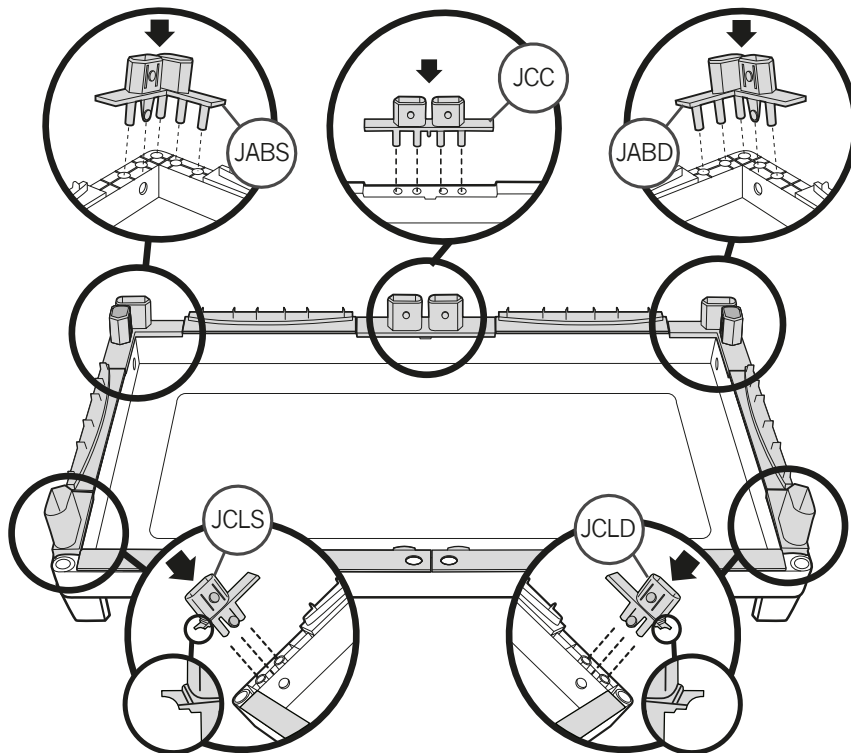

4

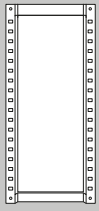

JMN x 2

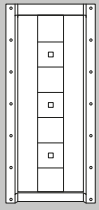

JMU x 2

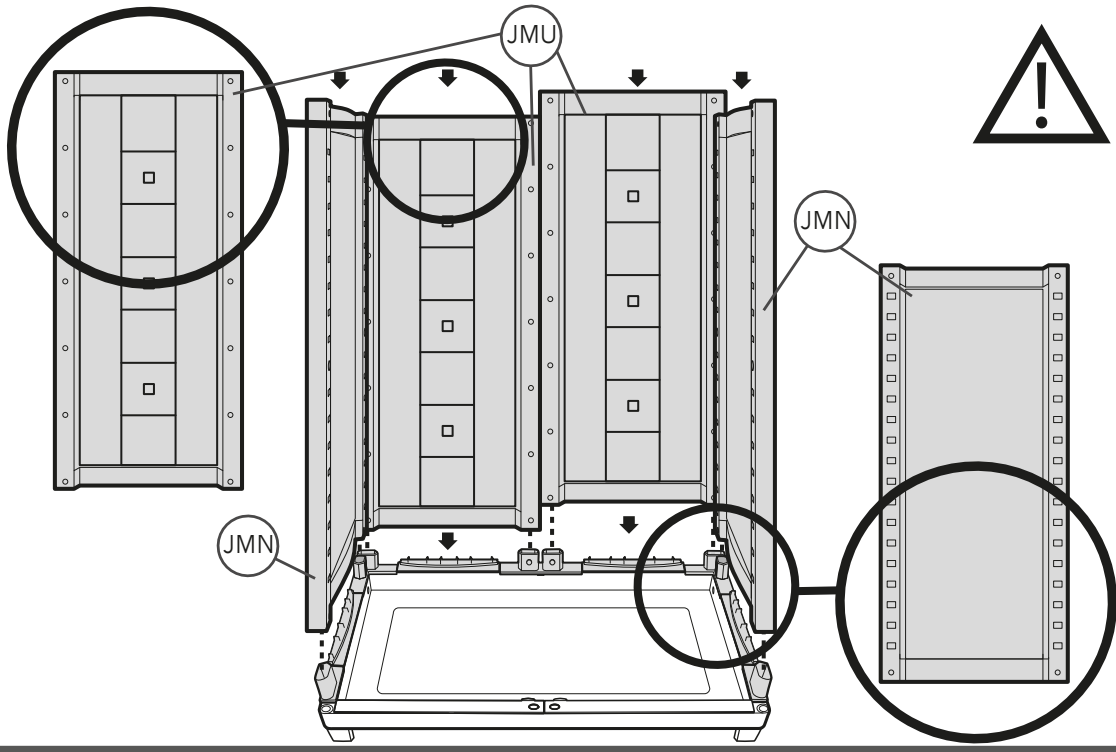

5



JCPS x 2



JCPD x 2

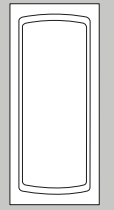

FMU1 x 2

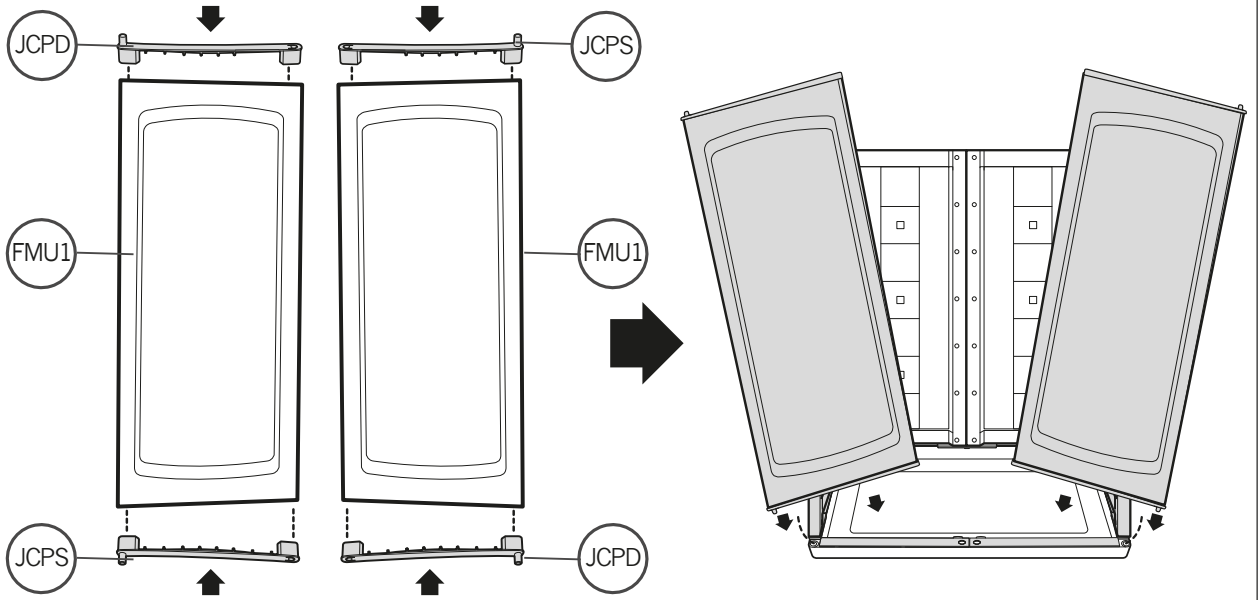

6

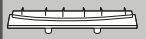

JRBT x 4



JRPS x 1



JRPD x 1



JBT

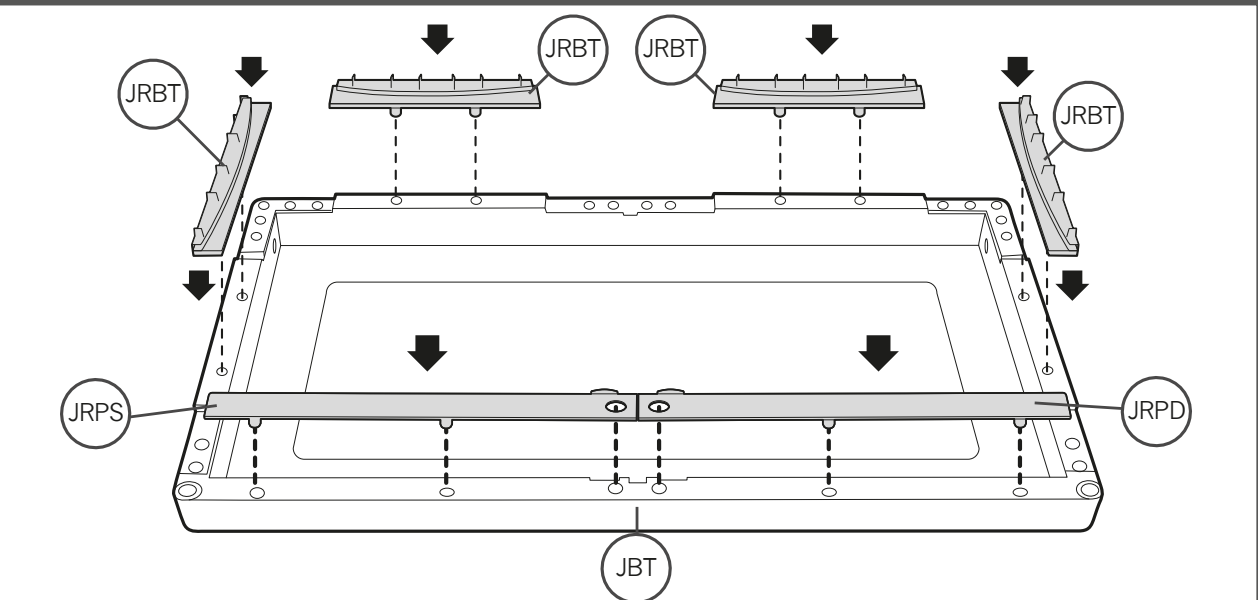

7

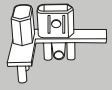

JABD x 1

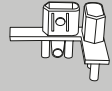

JABS x 1



JCLS x 1



JCLD x 1

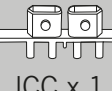

JCC x 1

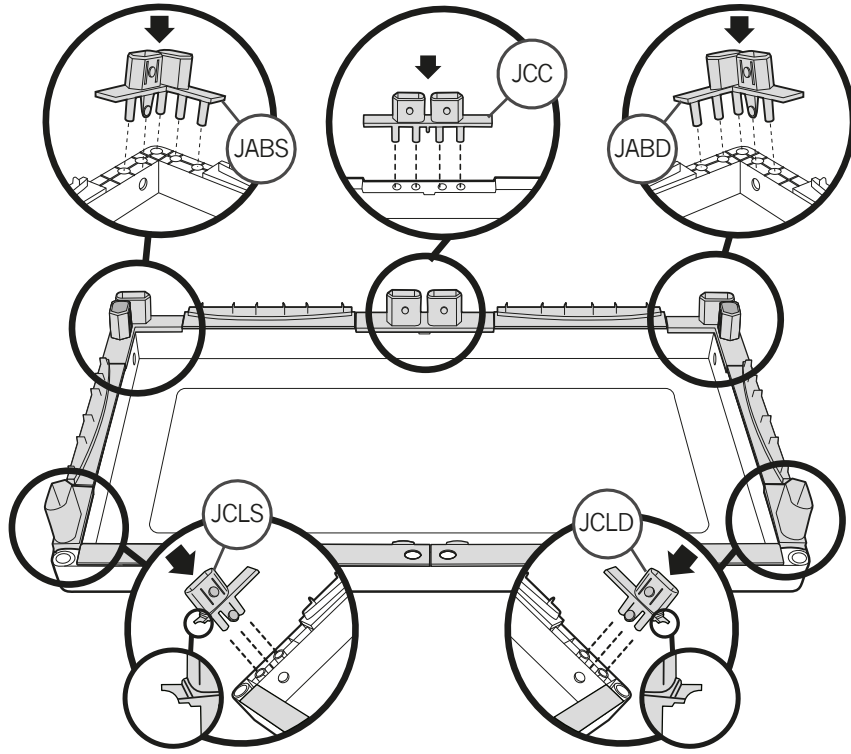

8



UTS x 2



UTD x 2

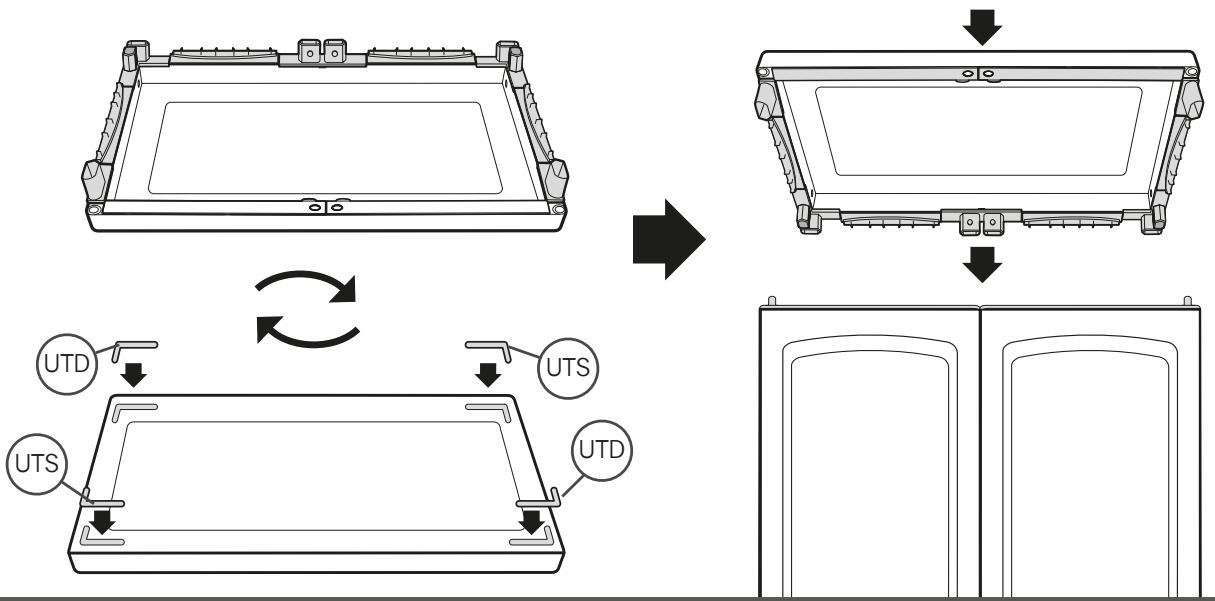

9

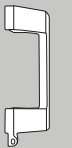

UMD x 1



x 2



x 2

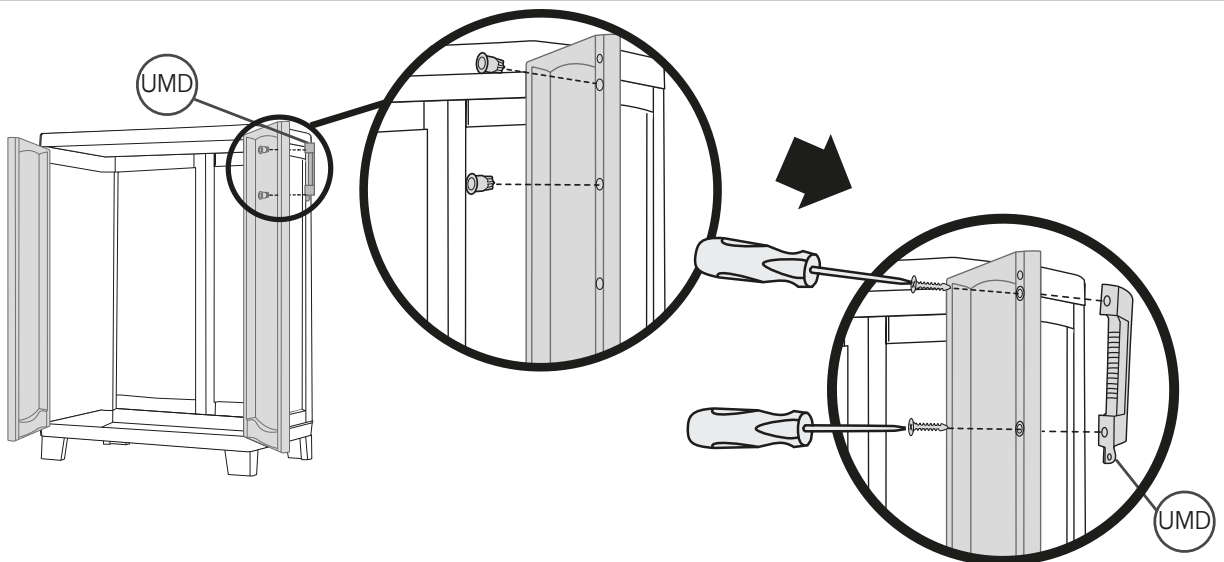

10



UMS x 1



x 2



x 2

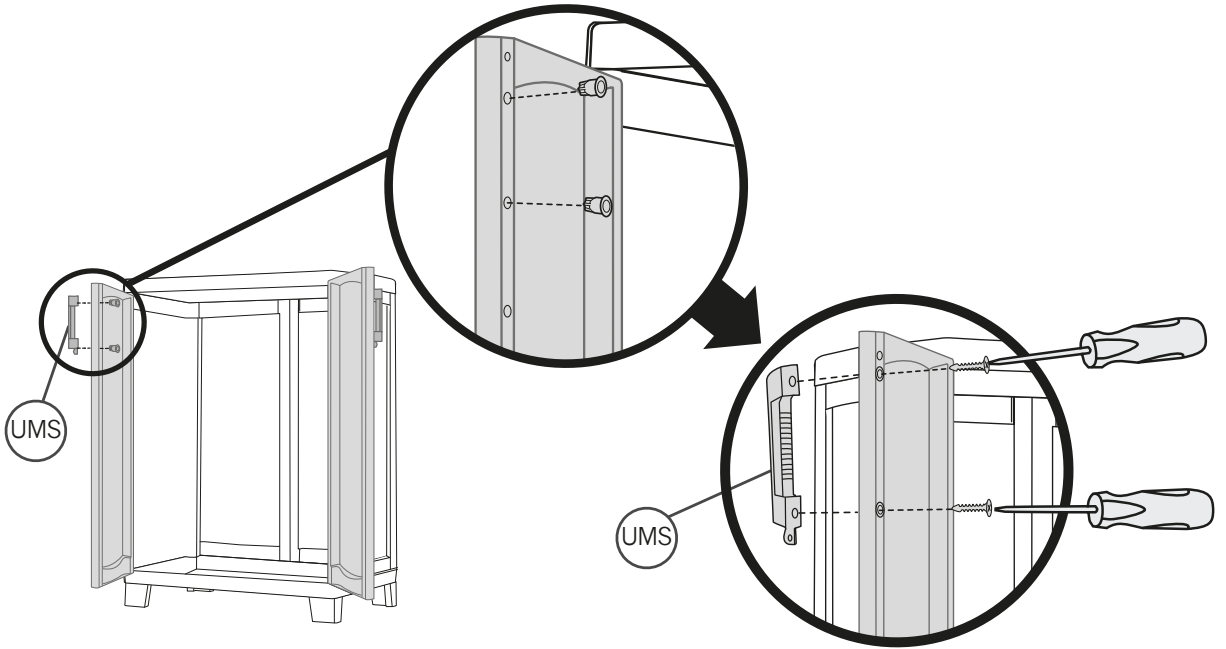

11



JFR x 4



JGR x 4



JRA x 1

