

SWISS MADE 



GEBRAUCHSANWEISUNG
MODE D'EMPLOI
INSTRUCTION MANUAL
ISTRUZIONI PER L'USO

TTM 

GEBRAUCHSANWEISUNG MODE D'EMPLOI INSTRUCTION MANUAL ISTRUZIONI PER L'USO

Deutsch	
Guten Tag	3
Montage / Aufbau	4
Raclettezubereitung	6
Unsere klassischen Geräte...	8
Raclette easy	10
Raclette accessoires...	11
Sicherheitshinweise	12

English	
Hello	23
Assembly / Set-up	24
Preparing the Raclette	26
Our classic appliances...	28
Raclette easy	30
Raclette accessories...	31
Safety Instructions	32

Français	
Bonjour	13
Montage	14
Préparation de la raclette	16
Nos appareils classiques...	18
Raclette easy	20
Accessoires pour la raclette...	21
Prescriptions de sécurité	22

Italiano	
Buongiorno	33
Montaggio	34
Come preparare le raclette	36
I nostri apparecchi classici	38
Accessori per raclette	40
Avvertenze	42
Garantie - Guarantee	43

GUTEN TAG

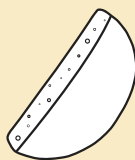

Raclette ist ein altes Bauernrezept aus den Walliser Bergen, mit Gluthitze gegrillter Alpenkäse, ein Leckerbissen. Heute, mit Hilfe eines TTM-Raclette-Ofens, ist klassisches Raclette für jedermann schnell und einfach zuzubereiten.

Sie benützen dazu, je nach Grösse der Tafelrunde, einen oder zwei halbe Laibe Raclette-Käse. Die Schnittfläche wird unter die Hitze geführt, bis der Käse zu schmelzen beginnt. Das Geschmolzene wird dann direkt auf einen Teller abgestrichen. Klassischerweise reicht man zum Raclette Gschweltn (Pellkartoffeln), Essiggurken und Silberzwiebeln. Der kulinarischen Fantasie sind jedoch keine Grenzen gesetzt.

Traditionsgemäss fängt jeder Gast sofort zu essen an, solange der Käse warm ist, und wartet nicht, bis alle bedient sind. Begleiten Sie dieses köstliche Mahl mit einem edlen, trockenen Weisswein oder Tee.

Guten Appetit!

MONTAGE/AUFBAU



1

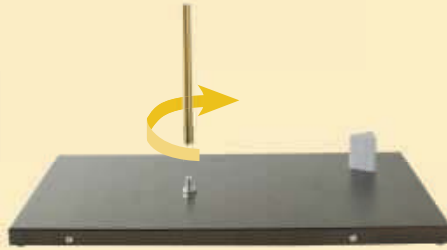

Spindel mithilfe eines Schraubenziehers oder einer Münze auf der Bodenplatte festschrauben.

2

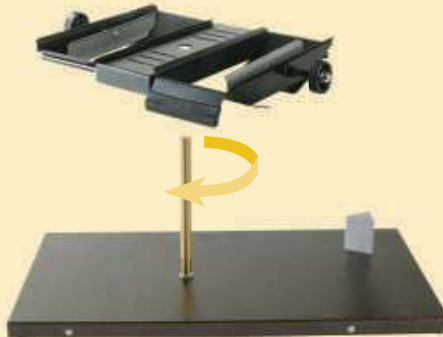

Den Käsehalter auf die Spindel schrauben und im Uhrzeigersinn nach unten drehen.

REINIGUNG

Nur mit feuchtem Tuch reinigen und gut trocknen. Die Metallteile nie ins Wasser tauchen oder in den Geschirrspüler legen. Schwarze Metallteile ab und zu mit Speiseöl leicht einölen.

3

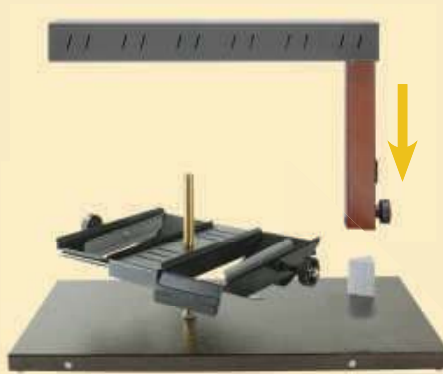

Den Heizarm auf den Aluminiumbolzen stecken.

4



Den Heizarm mit der Rändelschraube fixieren, dann Stromkabel einsetzen. Bei der ersten Inbetriebnahme kann leichter Rauch entstehen. Dies ist normal und bedeutet keine Gefahr.

RACLETTE-ZUBEREITUNG



1 Käselaib auf Käsehalter legen.



2 Käselaib festspannen.



5 Käsehalter um die Spindel drehen.



6 Käse in Schräglage heben und mit Raclettemesser (glatte Seite) auf Teller abstreichen.



3 Käse nach oben zum Heizkörper drehen (Abstand 2cm). Einschalten: Schalter auf 1 stellen oder Kabel einstecken.

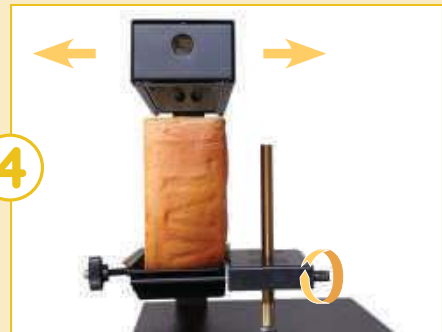

4 Käsehalter mittels Rändelschraube zentral unter der Heizung positionieren.

Tipps

Nach jeweils 4-5 Raclettes verbleibt an den Rändern eine gegrillte Kruste. Diese feine Kruste mit der gezackten Seite des Raclettemessers abschneiden und zusammen mit einem Raclette servieren (sie heisst „raclette religieuse“, denn sie schmeckt himmlisch!).

Übrigbleibender Käse einfrieren oder für Gratins, belegte Brote oder Käseschnitten verwenden. Grosse Reste halten sich bis 8 Wochen im Kühlschrank, kleine 2-3 Wochen.

Übrigens: Der Teller kann zum Vorwärmen auf den Heizkörper gelegt werden.

UNSERE KLASSISCHEN GERÄTE...

	Party	Racl'Plus	Racletta
			
Käse	¼ rund	¼ eckig	1/8 eckig
Leistung	600W	450W	600W
On-off-Schalter	Nein	Ja	Nein
Schwenkarm	Ja	Ja	Ja

	Super	Evolène
		
Käse	2 x ½ rund und eckig	2 x ½ rund und eckig
Leistung	1000W	2 x 1000W
On-off-Schalter	Ja	2 x (1 pro Heizung)
Schwenkarm	Ja	2 x (1 pro Käse)

Ambiance	POP	Zinal	DS 2000
			
½ rund und eckig	½ rund und eckig	½ rund und eckig	2 x ½ rund und eckig
1000W	1000W	1000W	1000W
Ja	Nein	Ja	Ja
Nein	Ja	Ja	Nein

Trio	Gas-Geräte		
	Easy-Gaz	Brio-Gaz	Brio-Plus
			
3 x ½ rund	½ rund und eckig	2 x ½ rund und eckig	2 ½ rund und eckig
2 x 1000W	1.9 – 2.5 kW	2.6 – 3.4 kW	2.6 – 3.4 kW
2 x (1 pro Heizung)	Nein	Nein	Nein
Nein	Nein	Ja	Ja

RACLETTE EASY (ohne Strom und Gas)

	Pico	Twiny Cheese schwarz	Twiny Cheese inox
			
Heizkörper	3 Kerzen	6 Kerzen	6 Kerzen
Artikel-Nr.	Art. 100.033	Art. 100.025	Art. 100.029

	Twiny Cheese rot	Twiny Cheese Heidi	Racly
			
Heizkörper	6 Kerzen	6 Kerzen	1 Pastenbrenner
Artikel-Nr.	Art. 100.024	Art. 100.007	Art. 100.021

RACLETTE ACCESSOIRES...

Profi	Chef	Support inox	Resty
			
Abstreichmesser	mit Antihaf-Beschichtung	Lange Auflage für eckigen Käse	Zum Aufbrauchen von Käseresten
Art. 800.001	Art. 800.071	Art. 102.1032	Art. 102.105

Käsehalter ½ Käse	Käsehalter 2 x ½ Käse	Käsehalter ½ Käse Linkshänder	Schlauch und Druckregler
			
Runder und eckiger Käse	Runder und eckiger Käse	Runder und eckiger Käse	
Art. 101.052	Art. 101.101	Art. 101.059	Art. 800.091

SICHERHEITSHINWEISE



Lesen Sie diese Gebrauchsanweisung aufmerksam durch, um sich mit dem Gerät vertraut zu machen, bevor Sie es benutzen. Bewahren Sie diese Gebrauchsanweisung auf.



Nie mit Wasser oder anderen Flüssigkeiten in Berührung bringen.
Kurzschlussgefahr!



Nur auf standsichere Abstellflächen legen. Mindestabstand zur Wand 30 cm.



- Das Gerät soll nur von Erwachsenen benutzt werden.
- Nie in der Nähe von leicht entzündbaren Materialien benutzen.
- Gerät nie auf leicht brennbare Unterlagen stellen (Papiertücher etc.)
- Das Gerät nicht ohne Käse in Betrieb lassen.
- Auch bei kurzen Unterbrüchen der Käseerhitzung das Gerät ausschalten.
- Teile des Geräts werden heiss.
- Nie den Heizkörper anfassen.
- Nach Ausschalten 20 min lang abkühlen lassen.

BONJOUR

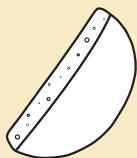

La raclette est une vieille recette paysanne du Valais faite à base de fromage grillé au feu de bois. Un vrai régal ! Aujourd'hui, grâce aux appareils TTM, la raclette traditionnelle est à la portée de tous, aisément et rapidement.

Prenez une ou deux demi-meules de fromage à raclette selon le nombre de convives. Placez la demi-meule sous la source de chaleur, jusqu'au moment où elle commence à fondre.

Raclez le fromage fondu directement sur une assiette et servez-la accompagnée de pommes de terre, d'oignons et de cornichons.

La raclette doit être mangée chaude, sans attendre que tout le monde soit servi.

Accompagnez ce délicieux repas avec un vin blanc sec ou du thé.

Bon appétit !

MONTAGE



1

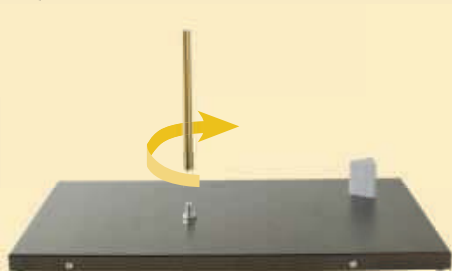

Fixer la tige filetée sur le plateau à l'aide d'un tournevis ou d'une pièce de monnaie.

2



Visser le porte-fromage sur la tige filetée et le faire descendre en le tournant dans le sens des aiguilles d'une montre.

NETTOYAGE

Nettoyer uniquement avec un chiffon humide. Bien essuyer ensuite. Les parties métalliques ne doivent jamais être trempées dans l'eau. De temps en temps, huiler légèrement les parties métalliques noires avec de l'huile comestible.

3



Emboîter le bras chauffant sur le triangle en aluminium du plateau.

4



Fixer le bras chauffant à l'aide de la molette, brancher ensuite le cordon électrique. Lors de la première utilisation de l'appareil, une légère fumée peut se dégager. Cela est normal et sans danger.

PRÉPARATION DE LA RACLETTE



1 Poser le fromage sur le support.



2 Serrer la meule de fromage.



5 Tourner le porte-fromage autour de la tige filetée.



6 Incliner le fromage et racler dans l'assiette (côté lisse du couteau).



Faire monter le fromage sous le corps de chauffe (à 2 cm). Enclencher : interrupteur sur 1 ou brancher le cordon.

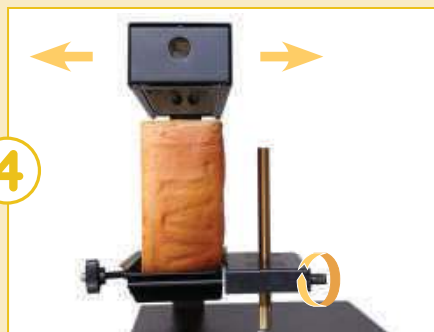

Positionner le porte-fromage au centre sous le corps de chauffe au moyen de la petite vis moletée.

Astuces

Après 4-5 raclettes, une croûte grillée se forme sur les bords du fromage. Couper cette fine croûte (côté microdenté du couteau) et la servir avec une raclette (elle se nomme « raclette religieuse », car elle est divinement savoureuse !).

Congeler le fromage restant ou l'utiliser pour des gratins, des tranches au fromage ou le manger froid. Les grands morceaux se conservent au réfrigérateur jusqu'à 8 semaines, les plus petits 2 à 3 semaines.

Par ailleurs : l'assiette peut être posée sur le corps de chauffe pour le préchauffage.

NOS APPAREILS CLASSIQUES...

	Party	Racl'Plus	Racletta
			
Fromage	¼ rond	¼ carré	1/8 carré
Puissance	600W	450W	600W
Interrupteur on-off	Non	Oui	Non
Bras pivotant	Oui	Oui	Oui

	Super	Evolène
		
Fromage	2 x ½ rond et carré	2 x ½ rond et carré
Puissance	1000W	2 x 1000W
Interrupteur on-off	Oui	2 x (1 par chauffage)
Bras pivotant	Oui	2 x (1 par fromage)

Ambiance	POP	Zinal	DS 2000
			
½ carré et rond	½ carré et rond	½ carré et rond	2 x ½ rond et carré
1000W	1000W	1000W	1000W
Oui	Non	Oui	Oui
Non	Oui	Oui	Non

Trio	Appareils à gaz		
	Easy-Gaz	Brio-Gaz	Brio-Plus
			
3 x ½ rond	½ rond et carré	2 x ½ rond et carré	2 x ½ rond et carré
2 x 1000W	1.9 – 2.5 kW	2.6 – 3.4 kW	2.6 – 3.4 kW
2 x (1 par chauffage)	Non	Non	Non
Non	Non	Oui	Oui

RACLETTE EASY (sans gaz ni électricité)

	Pico	Twiny Cheese noir	Twiny Cheese inox
			
Chauffage	3 bougies	6 bougies	6 bougies
Numéro d'article	N° 100.033	N° 100.025	N° 100.029

	Twiny Cheese rouge	Twiny Cheese Heidi	Racly
			
Chauffage	6 bougies	6 bougies	1 brûleur à pâte
Numéro d'article	N° 100.024	N° 100.007	N° 100.021

ACCESSOIRES POUR LA RACLETTE...

Profi	Chef	Support inox	Resty
			
Couteau à raclette	Avec revêtement anti-adhésif	Support long pour fromage carré	Pour utiliser les restes de fromage
N° 800.001	N° 800.071	N° 102.1032	N° 102.105

Porte-fromage 1/2 meule	Porte-fromage 2 x 1/2 meule	Porte-fromage 1/2 meule gaucher	Détendeur va- riable avec tuyau
			
Rond et carré	Rond et carré	Rond et carré	
N° 101.052	N° 101.101	N° 101.059	N° 800.091

PRESCRIPTIONS DE SÉCURITÉ



Lisez attentivement ce mode d'emploi afin de vous familiariser avec l'appareil avant la première utilisation. Conservez-le pour un usage ultérieur.



L'appareil ne doit jamais entrer en contact avec de l'eau ou avec tout autre liquide : danger de court-circuit !



Ne posez l'appareil que sur une surface plane et stable. Distance minimale entre l'appareil et une paroi : 30 cm.



- L'appareil doit être utilisé uniquement par des adultes.
- Ne pas utiliser l'appareil à proximité de matériaux inflammables.
- Ne pas faire fonctionner l'appareil sans fromage.
- Éteindre l'appareil même en cas de courtes interruptions durant le temps du repas.
- Ne jamais placer l'appareil sur une surface facilement inflammable (papiers essuie-tout, etc.).
- Des parties de l'appareil deviennent chaudes
- Ne jamais toucher le corps de chauffe.
- Laisser refroidir pendant 20 minutes après avoir éteint l'appareil.

HELLO

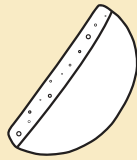

Raclette is an old farmer's recipe from the Valais Alps, a real delicacy with Alpine cheese grilled with the heat of embers. Today everyone can make classic raclette quickly and easily using a TTM-Raclette oven.

To make it, you use one or two half-wheels of raclette cheese depending on the number of your guests. Just hold the cutting surface under the heat until the cheese begins to melt. The melted cheese is then scraped off directly onto a plate and served with boiled potatoes, baby onions and pickled gherkins. However, there are no limits to the culinary imaginations.

By tradition, each guest begins to eat immediately while the cheese is still warm and does not wait until all have been served. Accompany this scrumptious meal with a fine, dry white wine or tea.

Enjoy!

ASSEMBLY / SET-UP



1

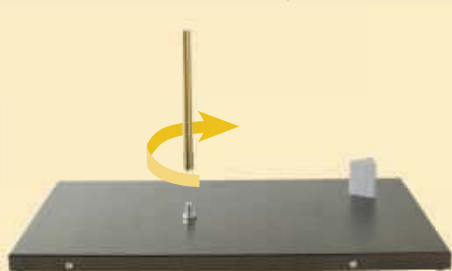

Screw the spindle onto the ground plate using a screwdriver or a coin.

2



Screw the cheese holder onto the spindle and turn downward clockwise.

CLEANING

Only clean with a damp cloth. Rub the machine dry after cleaning. Never submerge the metal parts in water. Lubricate the black metallic parts occasionally with cooking oil.

3

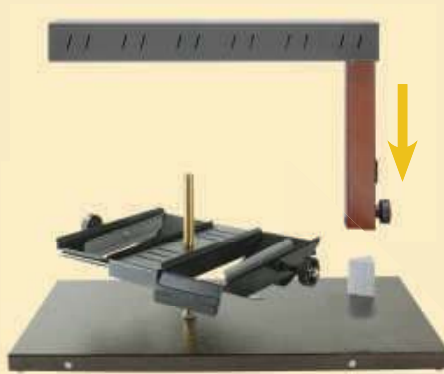

Place the heating arm with the column onto the aluminium bolt.

4



Attach the heating arm with the knurled screw, insert the power cable. A small amount of smoke can result during initial usage. This is normal and does not indicate any danger.

PREPARING THE RACLETTE



Place the cheese onto the cheese holder.



Clamp the cheese in position.



Turn the cheese holder around the spindle.



Lift the cheese holder into an angled position and scrape off onto the plate with the raclette knife (smooth side).



Turn the cheese upward to the heater (distance 2cm). Switch on: Set switch to 1 or connect cable.



Position the cheese holder centrally under the heater by means of the knurled screws.

Tips

A grilled crust forms on the edges after 4-5 raclettes each. Cut off this fine crust with the serrated side of the raclette knife and serve with a raclette (in French it's called "religieuse" ("religious raclette") because it tastes so heavenly!).

Freeze remaining cheese or use it for gratins, sandwiches or as cheese slices. Large left-over pieces keep for up to 8 weeks in the refrigerator, small ones for 2-3 weeks.





By the way: The plate can be placed on the heating arm for preheating.

OUR CLASSIC APPLIANCES...

	Party	Racl'Plus	Racletta
			
Cheese	¼ round	¼ square	1/8 square
Power	600W	450W	600W
On-off-switch	No	Yes	No
Swivel arm	Yes	Yes	Yes

	Super	Evolène
		
Cheese	2 x ½ round and square	2 x ½ round and square
Power	1000W	2 x 1000W
On-off-switch	Yes	2 x (1 per heater)
Swivel arm	Yes	2 x (1 per cheese)

Ambiance	POP	Zinal	DS 2000
			
½ round and square	½ round and square	½ round and square	2 x ½ round and square
1000W	1000W	1000W	1000W
Yes	No	Yes	Yes
No	Yes	Yes	No

Trio	Gas Appliances		
	Easy-Gaz	Brio-Gaz	Brio-Plus
			
3 x ½ round	½ round and square	2 x ½ round and square	2 x ½ round and square
2 x 1000W	1.9 – 2.5 kW	2.6 – 3.4 kW	2.6 – 3.4 kW
2 x (1 per heater)	No	No	No
No	No	Yes	Yes

RACLETTE EASY (without electricity or gaz)

	Pico	Twiny Cheese black	Twiny Cheese stainless steel
			
Heater	3 candles	6 candles	6 candles
Order number	N° 100.033	N° 100.025	N° 100.029

	Twiny Cheese red	Twiny Cheese Heidi	Racly
			
Heater	6 candles	6 candles	1 gel burner
Order number	N° 100.024	N° 100.007	N° 100.021

RACLETTE ACCESSORIES...

Profi	Chef	Support in stainless steel	Resty
			
Knife to scrape off the cheese	With anti-stick coating	Long support for square cheeses	To consume leftover cheese
N° 800.001	N° 800.071	N° 102.1032	N° 102.105

Holder for ½ cheese	Holder for 2 x ½ cheese	Holder for ½ cheese left-handers	Hose and pressure regulator
			
Round and square cheese	Round and square cheese	Round and square cheese	
N° 101.052	N° 101.101	N° 101.059	N° 800.091

SAFETY INSTRUCTIONS



Please read this manual carefully to familiarize yourself with the device before using it. Store these instructions.



Never bring the appliance into contact with water or other liquids.
Risk of short circuit.



Only place on stable surfaces. Minimum distance from the wall 30 cm.



- The appliance must only be handled by adults and responsible persons who are perfectly familiar with its use. Do not let children use the appliance.
- Never use near flammable materials.
- Never place the appliance on a highly flammable surface (paper towels, etc.).
- Never leave the appliance in operation without cheese.
- Even if the preparation of the raclette is interrupted for a short period of time, switch off the appliance.
- The surfaces of the oven become hot during use. Never touch the heater.
- Allow the appliance to cool down for at least 20 minutes after use.

BUONGIORNO

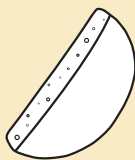

La Raclette è un' antica ricetta contadina dei monti del Vallese a base di formaggio alpino alla griglia, una vera prelibatezza. Oggi, con l'aiuto di un forno per raclette TTM, chiunque sarà in grado di preparare facilmente e rapidamente la classica raclette.

A seconda del numero di ospiti, servono una o due mezzette forme di formaggio per raclette. La superficie tagliata viene portata sotto al calore fino a quando il formaggio inizia a sciogliersi.

Il formaggio fuso viene poi raschiato direttamente su un piatto e servito con patate al cartoccio, cipolline perline e sottaceti. Ma non ci sono limiti alla fantasia culinaria.

Tradizionalmente, si inizia a mangiare subito, perché il formaggio deve essere caldo, e non si aspetta che tutti vengano serviti. Si consiglia di accompagnare questo delizioso pasto con un buon vino bianco secco o tè.

Buon appetito!

MONTAGGIO



1

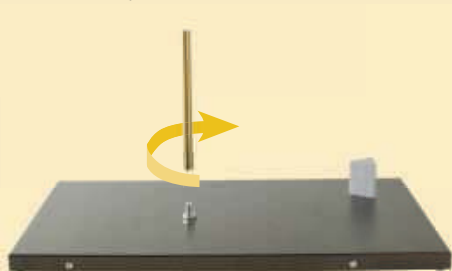

Avvitare l'asta filettata sulla piastra inferiore utilizzando un cacciavite o una moneta.

2

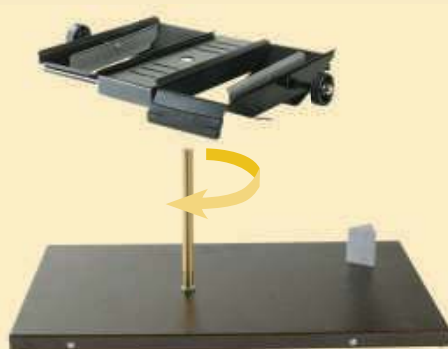

Avvitare il porta-formaggio sull'asta filettata e ruotare in senso orario verso il basso.

PULIZIA

Pulire solo con un panno umido. Asciugare il dispositivo dopo la pulizia. Non immergere mai le parti metalliche nell'acqua. Di tanto in tanto, oliare le parti di metallo con un po' di olio da cucina.

3



Inserire il braccio riscaldante con la colonna sul bullone di alluminio.

4

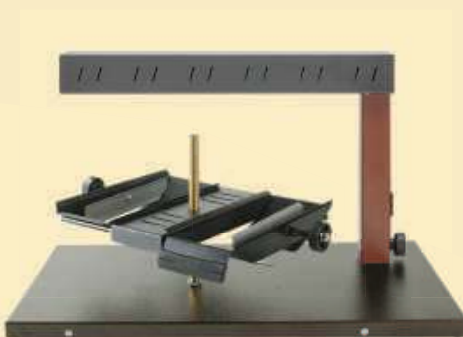

Fissare il braccio riscaldante con la vite a testa zigrinata, quindi inserire il cavo di alimentazione. Può essere emesso del fumo al primo utilizzo. Questo è normale e non comporta alcun pericolo.

COME PREPARARE LE RACLETTE



1

Mettere la forma di formaggio sull' supporto.



2

Fissare la forma di formaggio.



5

Girare il porta-formaggio attorno all' asta filettata.



6

Sollevere il formaggio in posizione inclinata e raschiare la raclette su un piatto con un coltello per raclette (lato liscio).



Girare il formaggio verso il riscaldatore (distanza 2 cm). Accendere: posizionare l'interruttore su 1 o collegare il cavo.

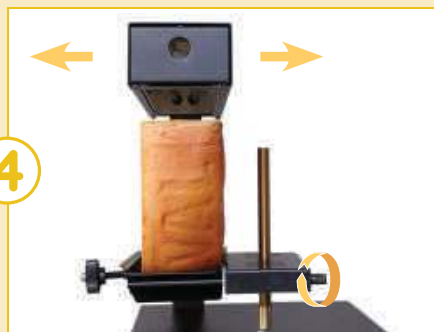

Posizionare il porta-formaggio al centro, sotto il riscaldatore, usando la vite zigrinata.

Consiglio

Dopo ogni 4-5 raclette rimane sui bordi una crosta grigliata. Tagliare questa crosta fine con il lato seghettato del coltello da raclette e servire con una raclette (si chiama "raclette religieuse", perché ha un sapore paradisiaco!).

Congelate il restante formaggio o usatelo per gratin, tramezzini o fette di formaggio. Gli avanzi di grandi dimensioni si conservano nel frigorifero per un massimo di 8 settimane, i piccoli per 2-3 settimane.





A proposito: Il piatto può essere messo sul braccio riscaldante per il preriscaldamento.

I NOSTRI APPARECCHI CLASSICI

	Party	Racl'Plus	Racletta
			
Formaggio	¼ rotondo	¼ quadrato	1/8 quadrato
Potenza	600W	450W	600W
Interruttore	No	Si	No
Braccio girevole	Si	Si	Si

	Super	Evolène
		
Formaggio	2 x ½ rotondo e quadrato	2 x ½ rotondo e quadrato
Potenza	1000W	2 x 1000W
Interruttore	Si	2 x (1 per resistenza)
Braccio girevole	Si	2 x (1 per formaggio)

Ambiance	POP	Zinal	DS 2000
			
½ rotondo e quadrato	½ rotondo e quadrato	½ rotondo e quadrato	2 x ½ rotondo e quadrato
1000W	1000W	1000W	1000W
Si	No	Si	Si
No	Si	Si	No

Trio	Gas Appliances		
	Easy-Gaz	Brio-Gaz	Brio-Plus
			
3 x ½ rotondo	½ rotondo e quadrato	2 x ½ rotondo e quadrato	2 x ½ rotondo e quadrato
2 x 1000W	1.9 – 2.5 kW	2.6 – 3.4 kW	2.6 – 3.4 kW
2 x (1 per resistenza)	No	No	No
No	No	Si	Si

RACLETTE EASY (senza elettricità e gas)

	Pico	Twiny Cheese nero	Twiny Cheese acciaio inox
			
Riscaldamento	3 candele	6 candele	6 candele
Numero di articolo	N° 100.033	N° 100.025	N° 100.029

	Twiny Cheese rosso	Twiny Cheese Heidi	Racly
			
Riscaldamento	6 candele	6 candele	1 gel burner
Numero di articolo	N° 100.024	N° 100.007	N° 100.0021

ACCESSORI PER RACLETTE

Profi	Chef	Supporto in acciaio inox	Resty
			
Coltello da raclette	Con rive stimento antiaderente	Supporto lungo per formaggi quadrati	Per consumare tutti gli avanzi.
N° 800.001	N° 800.071	N° 102.1032	N° 102.105

Supporto per ½ formaggio	Supporto per 2 x ½ formaggio	Supporto per ½ formaggio per mancini	Tubo flessibile e regolatore di pressione
			
Rotondo e quadrato	Rotondo e quadrato	Rotondo e quadrato	
N° 101.052	N° 101.101	N° 101.059	N° 800.091

AVVERTENZE



Leggere attentamente questo manuale per familiarizzare con il apparecchio prima di utilizzarlo. Conservare le presenti istruzioni.



Non portare mai a contatto con acqua o altri liquidi. Pericolo di corto circuito!



Appoggiare solo su superfici stabili. Distanza minima dalla parete 30 cm.



- L'apparecchio deve essere manipolato esclusivamente da persone adulte e responsabili che ne conoscano perfettamente l'utilizzazione. Non lasciare che i bambini utilizzino l'apparecchio.
- Non utilizzare mai in prossimità di materiali infiammabili.
- Non mettere mai l'apparecchio su una superficie facilmente infiammabile (asciugamani di carta, ecc.).
- Non lasciare mai l'apparecchio in funzione senza formaggio.
- Anche se la preparazione della raclette viene interrotta per un breve periodo di tempo, spegnere l'apparecchio.
- Le superfici del forno diventano calde durante l'utilizzazione. Non toccare mai il corpo di riscaldamento.
- Lasciare raffreddare l'apparecchio come minimo per 20 minuti dopo l'uso.

GARANTIE • GUARANTEE

Garantie

Wir leisten für dieses Gerät eine Garantie von 24 Monaten. Wir haften während dieser Zeit für alle Mängel, die auf Konstruktions- oder Materialfehler zurückzuführen sind, jedoch nicht für Selbstverschulden. Für die Ausführung einer Garantiarbeit ist diese Seite mit dem Gerät an uns zu senden. Die Garantie ist nur gültig mit Datum und Stempel des Verkäufers.

Garantie

Nous accordons une garantie de 24 mois à partir de la date de vente. Pendant toute la période de garantie, nous répondons de toutes les pièces de l'appareil qui pourraient se révéler défectueuses à la suite d'un défaut de fabrication ou de matériel. Toutefois, nous ne répondons pas des dégâts causés par une mauvaise manipulation de l'appareil. Pour toute réparation sous garantie, veuillez nous renvoyer l'appareil accompagné de cette page. La garantie n'est valable que si elle est munie de la date de vente et du cachet du vendeur.

Warranty

We provide a warranty of 24 months for this appliance. During this period, we are liable for all defects that can be attributed to construction and material defects but are not due to the fault of the claimant. Please send this page to us with the machine for warranty work to be performed. The warranty is only valid with the date and stamp of the seller.

Garanzia

Offriamo una garanzia di 24 mesi per questo dispositivo. Durante questo periodo siamo responsabili per tutti i difetti dovuti a difetti di costruzione o di materiale, ma non per colpa propria. Per i lavori in garanzia, questa pagina deve essere inviata insieme all'apparecchio. La garanzia è valida solo con data e timbro del venditore.

Verkaufsdatum, date de vente, date of purchase, data di vendita:

Verkäufer, vendeur, retailer, venditore:



Entdecken Sie weitere TTM-Produkte
Découvrez nos autres produits culinaires
Discover our other products
Scopri gli altri nostri prodotti culinari
www.ttmsa.ch

TTM

Traitements Thermiques SA
Z.I. Ile Falcon - CH-3960 Sierre

T +41 (0)27 455 42 12
info@ttmsa.ch