



	Side Apron
	Bordure latérale
	Panel lateral
	Piast ra laterale
	2 x Zijpaneel
	PARTE LATERAL
	Ścianka boczna
	Seit ent eil
	05-077B-01

	Goal Board
	Planchér pour le but
	Taplero de la portería
	Pannelo con apertura porta goal
	2 x Doelplaatje
	TABELA DA BALIZA
	Ścianka na bramkę
	Plat te mit Toröffnung
	05-077B-02

	Playfield
	Terrain de jeu
	Campo de juego
	Campo gioco
	1 x Speelveld
	Campo
	Boisko
	Spiel feld
	05-077B-03

	Right Leg
	Pied gauche
	Pat a izquierda
	Gamba destra
	2 x Rechter Poot
	Perna do lado direito
	Noga prawa
	rechtes Bein
	05-077B-04

	Left Leg
	Pied droite
	Pat a derecha
	Gamba sinistra
	2 x Linker Poot
	Perna do lado esquerdo
	Noga lewa
	linkes Bein
	05-077B-05

	Field Support
	Support de terrain
	Soporte del campo de juego
	Supporto del campo gioco
	2 x Steun voor speelveld
	Suporte do campo
	Wspornik boiska
	Spiel feld stüt zstrebe
	05-077B-06

	Goal Net
	Filet de but
	Red de la portería
	Rede da goal
	2 x Doelnet
	Baliza
	Bramka
	Tornet z
	05-077B-07

	Ball entry
	Entrée de ballon
	Entrada de la bola
	Ingresso palla
	2 x Balingang
	Entrada da bola
	Otwór do wrzucania piłki
	Balleinwurf
	05-077B-08

	Manual Scorer
	Compteur de score manuel
	Marcador manual
	Segnapunti manuale
	2 x Manuele Scoreteller
	Pont uador manual
	Licznik goli ręczny
	manuelleur Torzähler
	05-077B-09

	Safety End Cap
	embout de protection
	Tapón de seguridad del extremo
	cappucci di sicurezza
	8 x veiligheidsdopje
	Tampão de segurança
	Zaslepka zabezpieczająca
	Sicherheit skappe
	05-077B-10

	Goal Bottom Board
	Planchér pour le but
	La base de la portería
	Piast ra basre per la rete
	2 x Doelbasis
	parte inferior da tabela da baliza
	List wa spodnia bramki
	Torbodenplatte
	05-077B-11

	Leg Side Brace
	Attache latérale de pied
	Abrazadera lateral de pat a
	Sostegno laterale gamba
	2 x Zijst eun voor poot
	Painel central da perna
	Wspornik boczny nóg
	Bein-Querstrebe
	05-077B-12

	Player Rod Bushing
	Bague de tige
	Cojinete de la barra de jugador
	Boccola asta giocatore
	16x Bus voor spelerst ang
	Casquilho da vara do jogador
	Tulejka drążka
	St angenführung
	05-077B-13

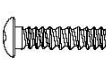
	Bolt, 6 x 50 mm
	Bullon, 6 x 50 mm
	Perno, 6 x 50 mm
	Bullone, 6 x 50 mm
	8 x bout, 6 x 50 mm
	parafuso, 6 x 50 mm
	Šruba, 6 x 50 mm
	Schraube, 6 x 50 mm
	05-077B-14

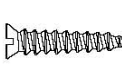
	Screw, 4 x 45 mm
	Vis, 4 x 45 mm
	Tornillo, 4 x 45 mm
	Vi te, 4 x 45 mm
	8 x Schroef, 4 x 45 mm
	parafuso, 4 x 45 mm
	Wkręt, 4 x 45 mm
	Schraube 4 x 45mm
	05-077B-15

	Screw, 4 x 40 mm
	Vis, 4 x 40 mm
	Tornillo, 4 x 40 mm
	Vi te, 4 x 40 mm
	16x Schroef, 4 x 40 mm
	parafuso, 4 x 40 mm
	Wkręt, 4 x 40 mm
	Schraube 4 x 40 mm
	05-077B-16

	Screw, 3.5 x 12 mm
	Vis, 3.5 x 12 mm
	Tornillo, 3.5 x 12 mm
	Vi te, 3.5 x 12 mm
	6x Schroef, 3.5 x 12 mm
	parafuso, 3.5 x 12 mm
	Wkręt, 3.5 x 12 mm
	Schraube, 3.5 x 12 mm
	05-077B-17

	washer, 18 mm
	Rondelle, 18 mm
	Arandela, 18 mm
	Rondella, 18 mm
	8 x Wasser, 18 mm
	Anilha, 18 mm
	Podkładka, 18 mm
	Unterlegscheibe, 18 mm
	05-077B-18

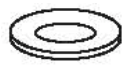
	Plastic Washer
	Rondelle en plastique
	Arandela de plástico
	Rondella di plastica
	16x Plastik wasser
	Anilha de plástico
	Podkładka plastikowa
	Unterlegscheibe
	05-077B-19

	Hand Grip
	Poignée
	Puño
	Impugnatura
	8 x Handvat
	Pega
	Rączka
	Handgriff
	05-077B-20

	Player Stop Ring
	Bague d'arrêt de joueurs
	Anilla de parada de jugador
	Anello di arrest o giocatore
	4 x St opring voor speler
	Anel bat ente do jogador
	Pierścień blokujący piłkarzyka
	Spieler -St opring
	05-077B-21

	1 Player rod assembly Team A
	Assemblée de tige à 1 joueur Team A
	Varilla de 1 jugador Team A
	Asta a 1 giocatore squadra A
	1x 1-Spelerst ang Team A
	Vara COM 1 jogador A
	Drążek z 1 piłkarzykami, drużyna A
	1-Spieler -St ange Team A
	05-077B-22

	2 Player rod assembly Team A
	Assemblée de tige à 2 joueurs Team A
	Varilla de 2 jugadores Team A
	Asta a 2 giocatori Team A
	1x 2-Spelerst ang Team A
	Vara COM 2 jogadores A
	Drążek z 2 piłkarzykami, drużyna A
	2-Spieler -St ange Team A
	05-077B-23

	3 Player rod assembly Team A
	Assemblée de tige à 3 joueurs Team A
	Varilla de 3 jugadores Team A
	Asta a 3 giocatori Team A
	1x 3-Spelerst ang Team A
	Vara COM 3 jogadores A
	Drążek z 3 piłkarzykami, drużyna A
	3-Spieler -St ange Team A
	05-077B-24

	5 Player rod Assembly Team A
	Assemblée de tige à 5 joueurs Team A
	Varilla de 5 jugadores Team A
	Asta a 5 giocatori squadra A
	1 x 5-Spelerstang Team A
Vara com 5 jogadores da Equipa A	
Drążek z 5 piłkarzykami, drużyna A	
05-077B-25	5-Spieler-Stange Team A

	1 Player rod Assembly Team B
	Assemblée de tige à 1 joueur Team B
	Varilla de 1 jugador Team B
	Asta a 1 giocatore squadra B
	1 x 1-Spelerstang Team B
Vara com 1 jogador Equipa B	
Drążek z 1 piłkarzykiem, drużyna B	
05-077B-26	1-Spieler-Stange Team B

	2 Player rod Assembly Team B
	Assemblée de tige à 2 joueurs Team B
	Varilla de 2 jugadores Team B
	Asta a 2 giocatori squadra B
	1 x 2-Spelerstang Team B
Vara com 2 jogadores Equipa B	
Drążek z 2 piłkarzykami, drużyna B	
05-077B-27	2 - Spieler -Stange Team B

	3 Player rod Assembly Team B
	Assemblée de tige à 3 joueurs Team B
	Varilla de 3 jugadores Team B
	Asta a 3 giocatori squadra B
	1 x 3-Spelerstang Team B
Vara com 3 jogadores Equipa B	
Drążek z 3 piłkarzykami, drużyna B	
05-077B-28	3-Spieler-Stange Team B

	5 Player rod Assembly Team B
	Assemblée de tige à 5 joueurs Team B
	Varilla de 5 jugadores Team B
	Asta a 5 giocatori squadra B
	1 x 5-Spelerstang Team B
Vara com 5 jogadores Equipa B	
Drążek z 5 piłkarzykami, drużyna B	
05-077B-29	5-Spieler-Stange Team B

	2 hole Hollow Player Rod
	Tige à 2 trous
	Barra hueca de 2 agujeros
	Asta vuota a 2 fori
	2 x 2-lege gat en spelerstang
Vara com 2 orificios para jogadores	
Drążek do gry z 2 otworami	
05-077B-30	Hohlstange, 2 Löcher

	3 hole Hollow Player Rod
	Tige à 3 trous
	Barra hueca de 3 agujeros
	Asta vuota a 3 fori
	4 x 3-lege gat en spelerstang
Vara com 3 orificios para jogadores	
Drążek do gry z 3 otworami	
05-077B-31	Hohlstange, 3 Löcher

	5 hole Hollow Player Rod
	Tige à 5 trous
	Barra hueca de 5 agujeros
	Asta vuota a 5 fori
	2 x 5-lege gat en spelerstang
Vara com 5 orificios para jogadores	
Drążek do gry z 5 otworami	
05-077B-32	Hohlstange, 5 Löcher

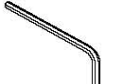
	5 mm Allen Key
	Clé hexagonale
	Llave Allen 5 mm
	Chiave a brugola 5 mm
	1 x Imbussleutel 5 mm
Chave sextavada de 5 mm	
Klucz sześciokątny 5 mm	
05-077B-33	Imbusschlüssel, 5 mm

	Football - A
	Ballon - A
	Pelota de futbol - A
	Pallone da calcio - A
	1 x Voetbal - A
	Bola de futebol - A
	Pilka - A
05-077B-34	Fußball - A

	Player Mounting Screw
	Vis de montage des joueurs
	Tornillo de fijación de jugador
	Vite di montaggio giocatori
	52 x Montageschroef voor speler
	Parafuso de fixação do jogador
	Wkręt do przykręcenia piłkarzyka
05-077B-35	Spieler-Befestigungsschraube

	Rubber Bumper A
	Butoir en caoutchouc A
	Paragolpes de goma A
	Gommino di sostegno A
	16 x Rubberen Stooblokje A
	Batente de borracha A
	Odbojnik gumowy A
05-077B-36	Gummipuffer A

	Cross Barrel Nut
	Écrou croisé
	Tuerca cilíndrica de estrella
	Dado canna trasversale
	2 x Gekruiste looppoer
	Porca de cilindro cruzado
	Nakrętka z nacięciem
05-077B-37	Hülsemmutter

	Player Team A
	Joueur Team A
	Jugador Team A
	Giocatore squadra A
	11 x Speler Team A
	Jogador Equipa A
	piłkarzyk drużyny A
05-077B-38	Spieler Team A

	Player Team B
	Joueur Team B
	Jugador Team B
	Giocatore squadra B
	11 x Speler Team B
	Jogador Equipa B
	piłkarzyk drużyny B
05-077B-39	Spieler Team B

	Screw, 3.5 x 14 mm
	Vis, 3.5 x 14 mm
	Tornillo, 3.5 x 14 mm
	Vite, 3.5 x 14 mm
	8 x Schroef, 3.5 x 14 mm
	Parafuso, 3.5 x 14 mm
	Wkręt, 3.5 x 14 mm
05-077B-40	Schraube, 3.5 x 14 mm

	Left Leg Cap
	capuchon de patte gauche
	tapon de patte, izquierda
	cappuccio gamba sinistra
	2 x linkerpoet kapje
	Pé esquerdo
	Zaslepka do nogi, lewa
05-077B-41	linke Fußabdeckung

	Right Leg Cap
	capuchon de patte droite
	tapon de patte, derecha
	cappuccio gamba destra
	2 x rechterpoet kapje
	Pé direito
	Zaslepka do nogi, prawa
05-077B-42	rechte Fußabdeckung

	Leg Leveler
	Niveleur de pied
	Nivelador De patata
	Livellatore gamba
	4 x Pootnivelleerder
	Nivelador da perna
	Podstawka poziomująca do nogi
05-077B-43	Beinjustierschraube

	Screw, 4 x 37 mm
	Vis, 4 x 37 mm
	Tornillo, 4 x 37 mm
	Vite, 4 x 37 mm
	2 x Schroef, 4 x 37 mm
	Parafuso, 4 x 37 mm
	Wkręt, 4 x 37 mm
05-077B-44	Schraube, 4 x 37 mm

	Football - B
	Ballon - B
	Pelota de futbol - B
	Pallone da calcio - B
	1 x Voetbal - B
	Bola de futebol - B
	Pilka - B
05-077B-45	Fußball - B

**FIG. 1**

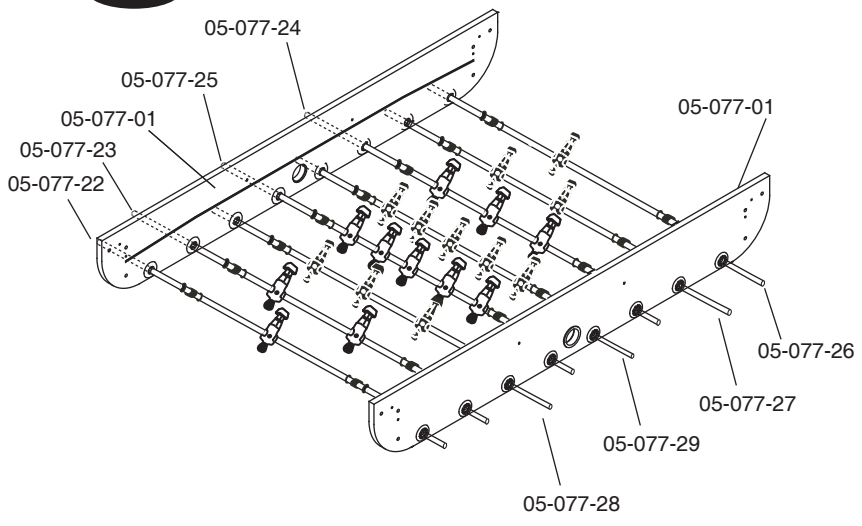

**FIG. 2**

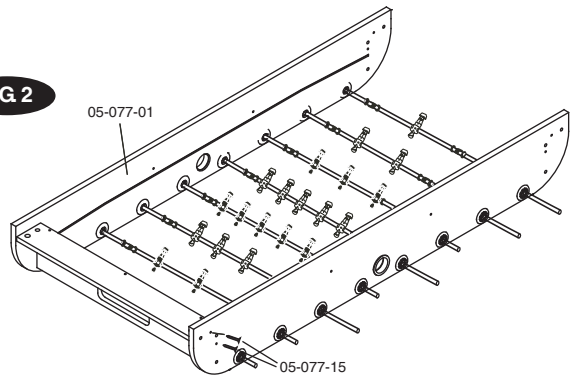

**FIG 2A**

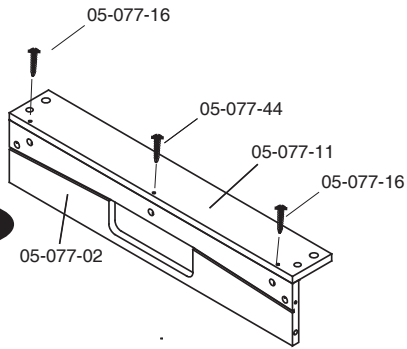

**FIG 2B**

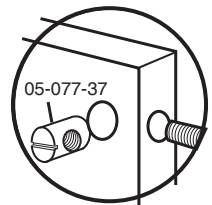

**FIG 3**

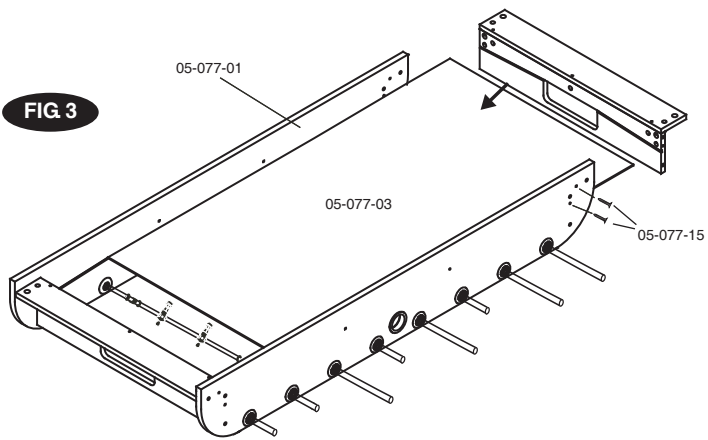

FIG 4

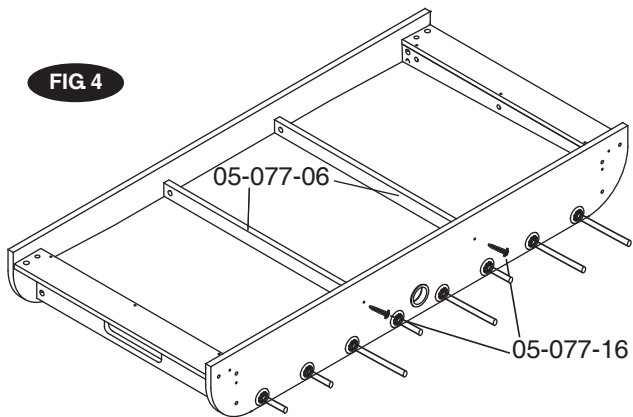

FIG 5

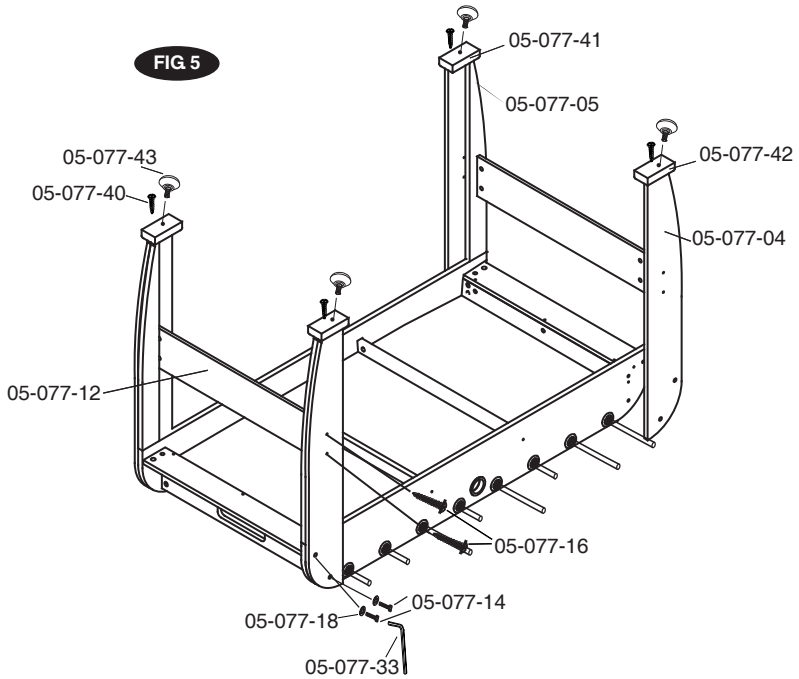

FIG. 6

