



7637

CITY





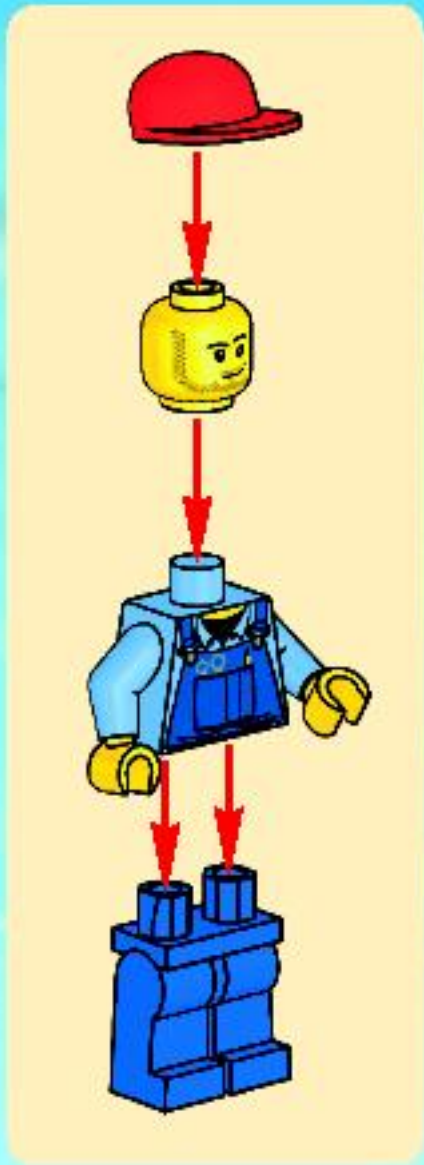

1



3



2



4



1

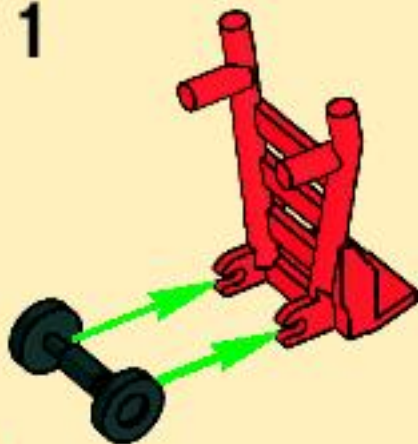

2



5



1



2



2x



1

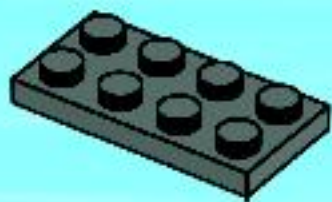

2

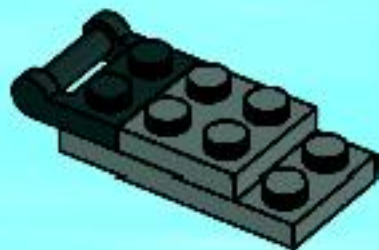

3

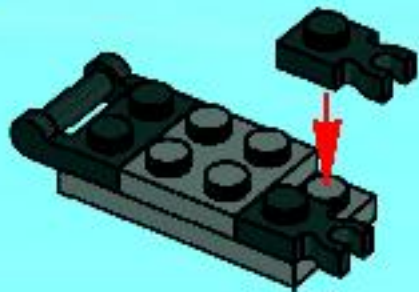

4

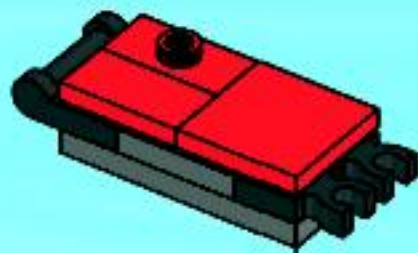

5

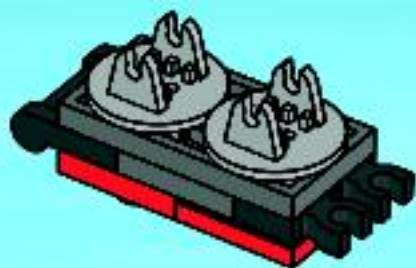

6

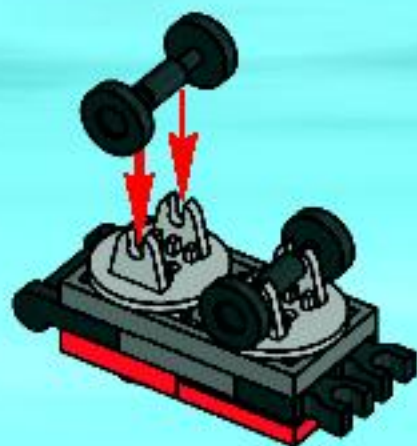

7

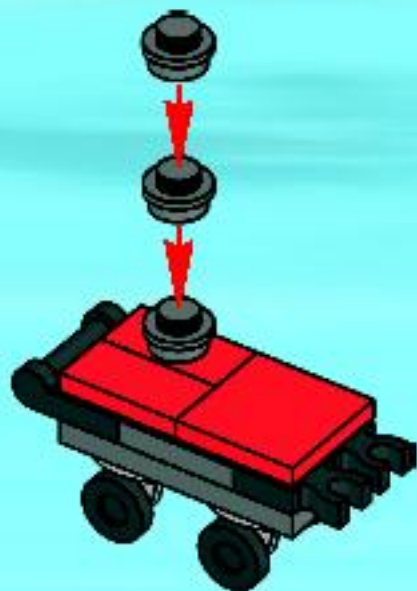

1



2



3



8



9





1

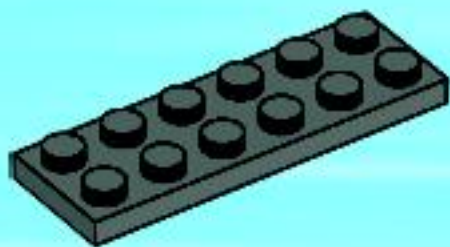

2

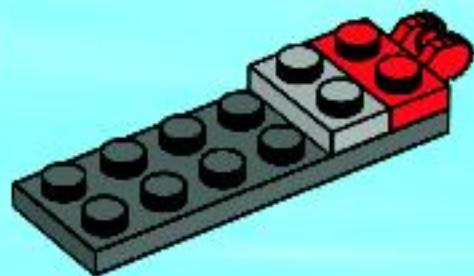

3

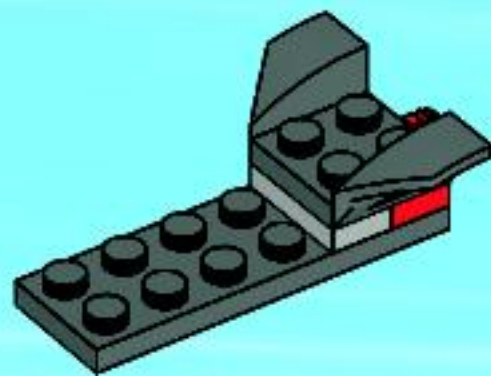

4

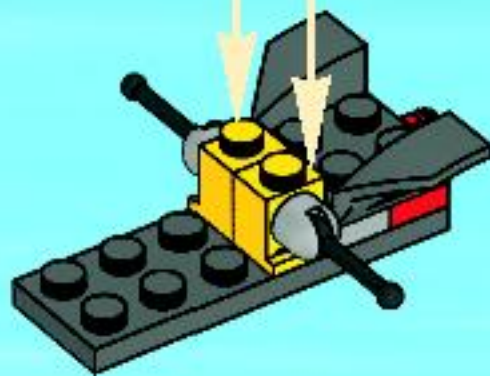
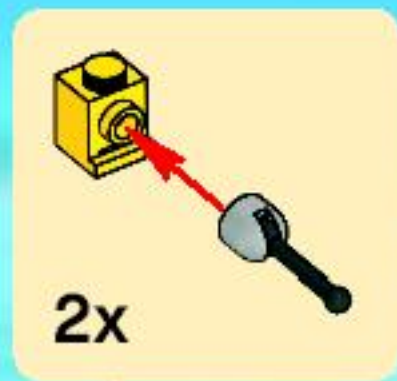

5

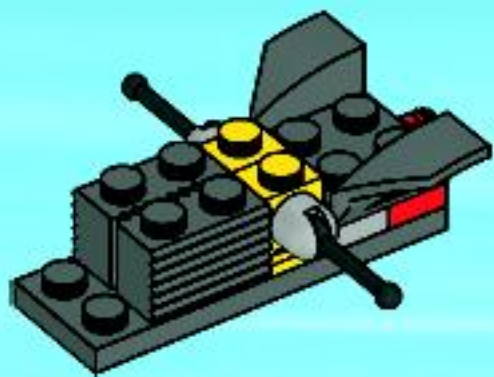

6

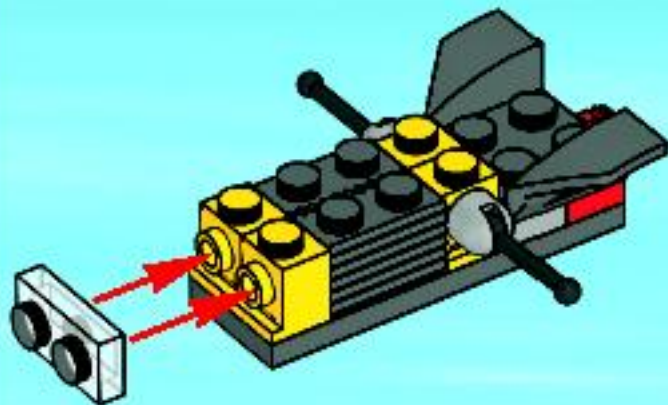

7

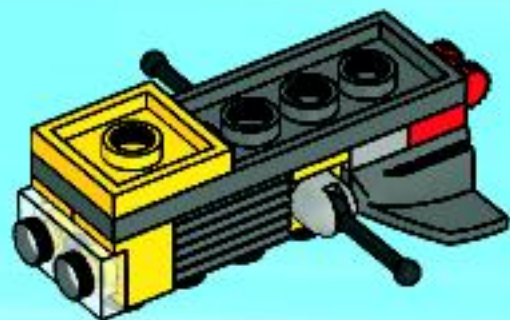

8

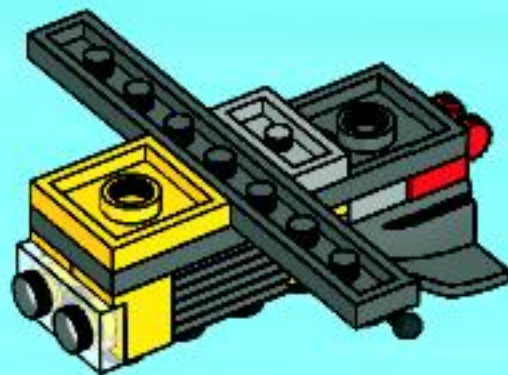

9

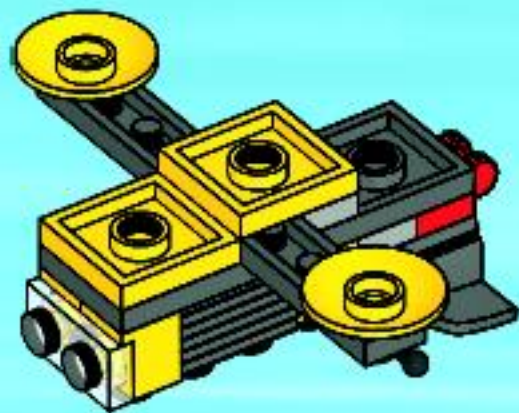

10

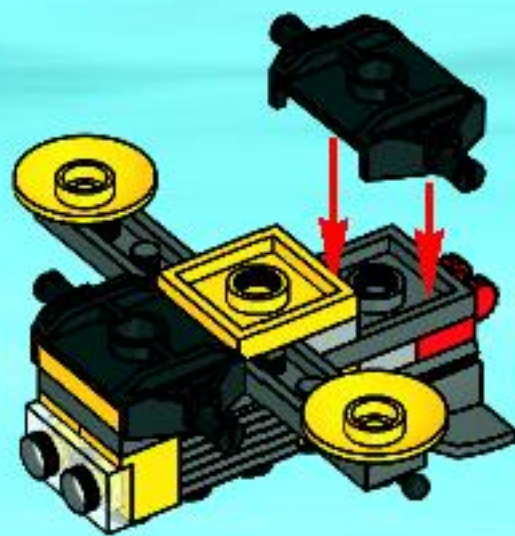

13



14





1

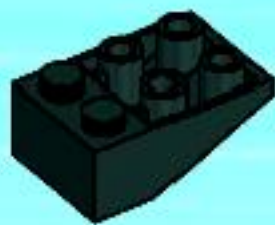

2



3



4

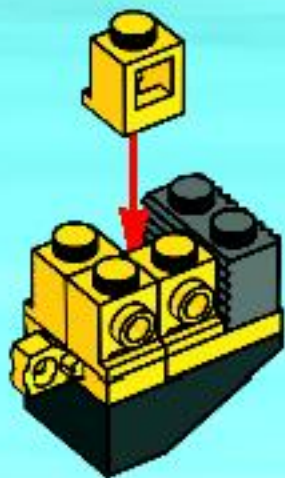

5

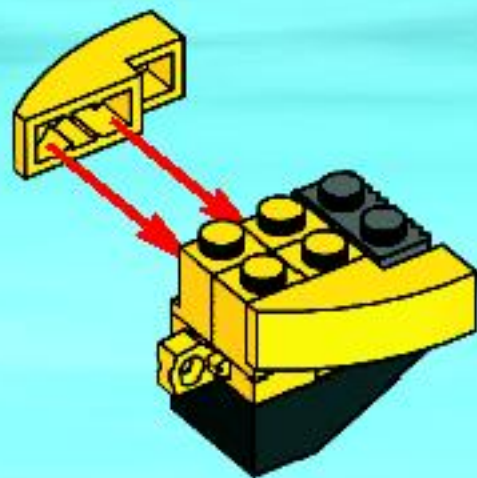

6



7



8

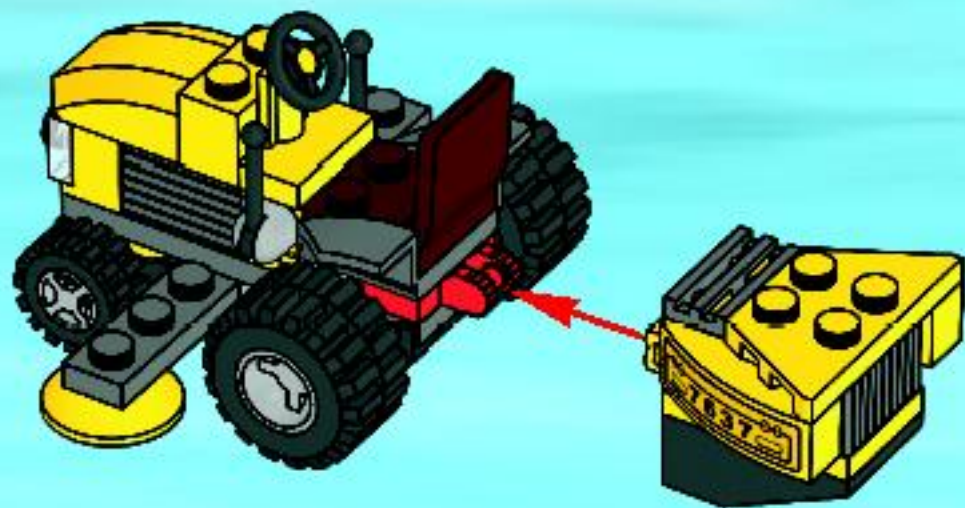

9

