

"BOARD" - Anbau - Regal

Nr. 4006.770	Nr. 4006.772	Nr. 4006.774	Nr. 4006.776
Nr. 4006.780	Nr. 4006.782	Nr. 4006.784	Nr. 4006.786
Nr. 4006.790	Nr. 4006.792	Nr. 4006.794	Nr. 4006.796

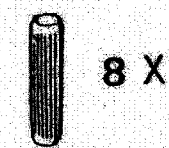
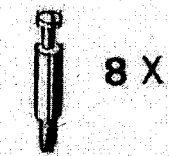
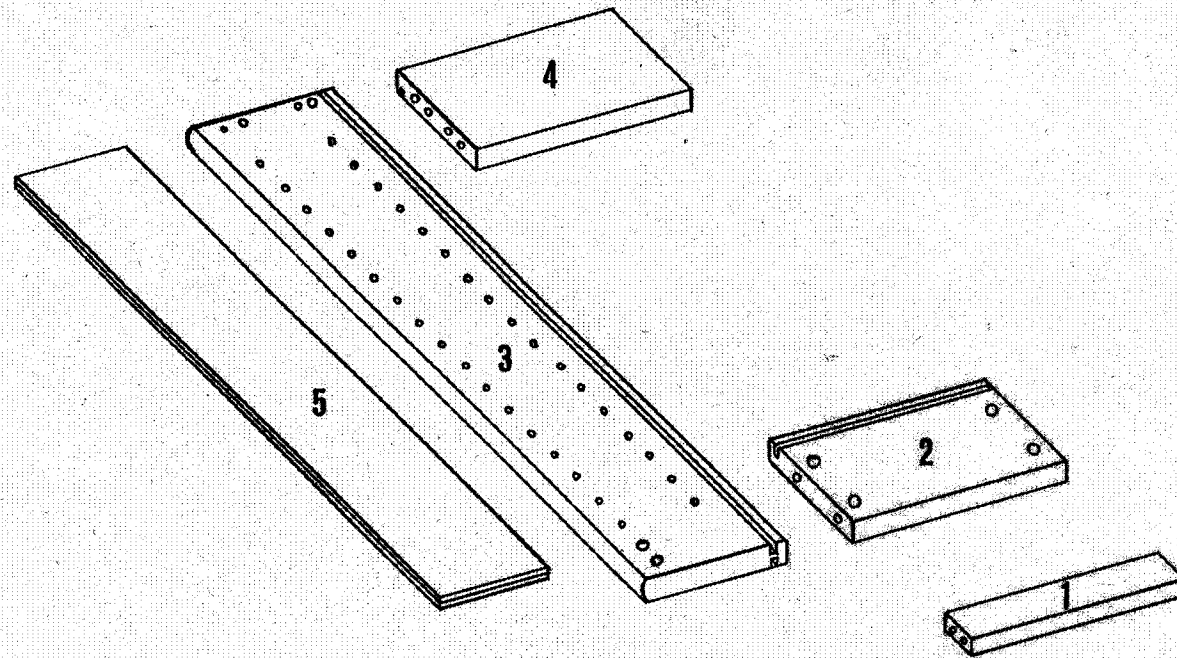
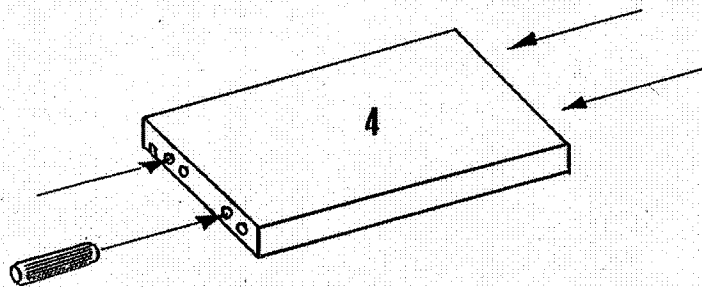
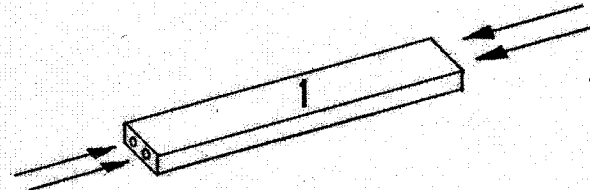
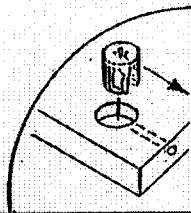
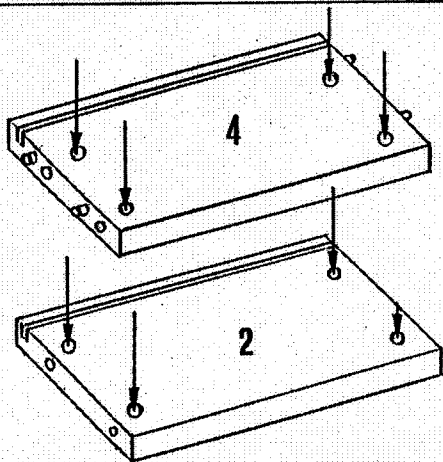
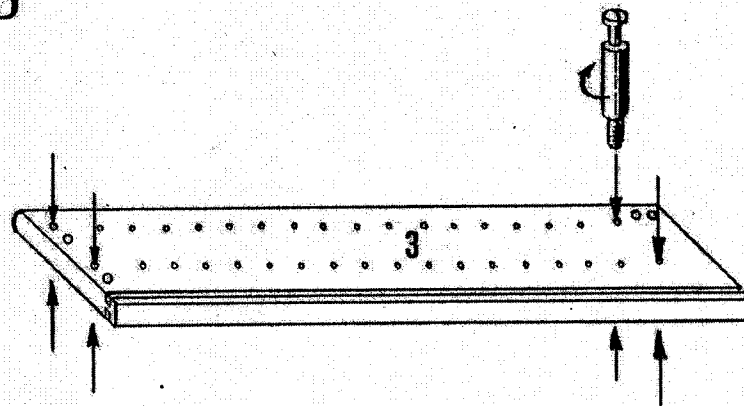

**A****B****C****D**

E

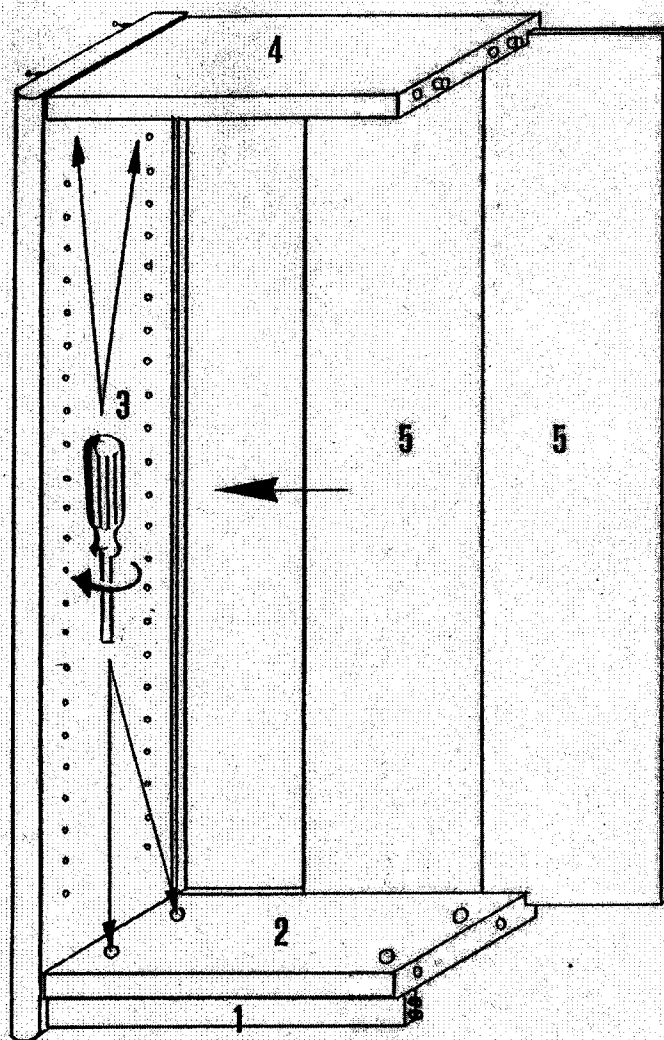

F

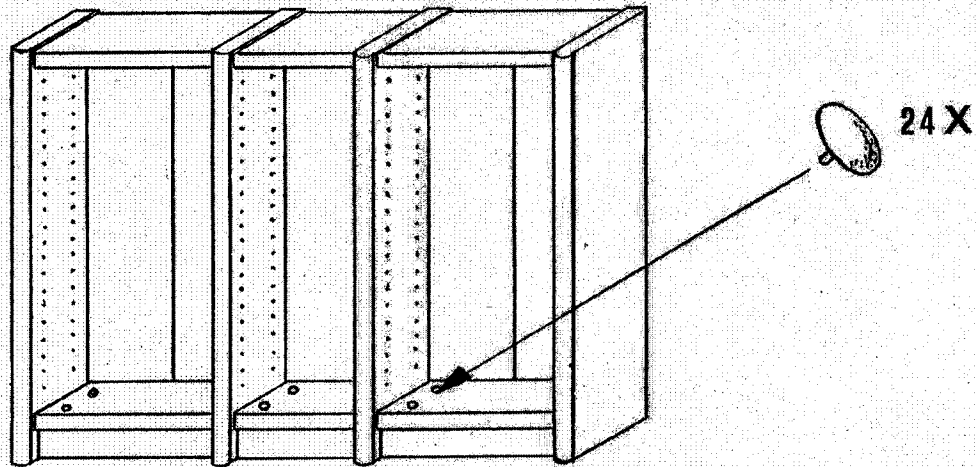
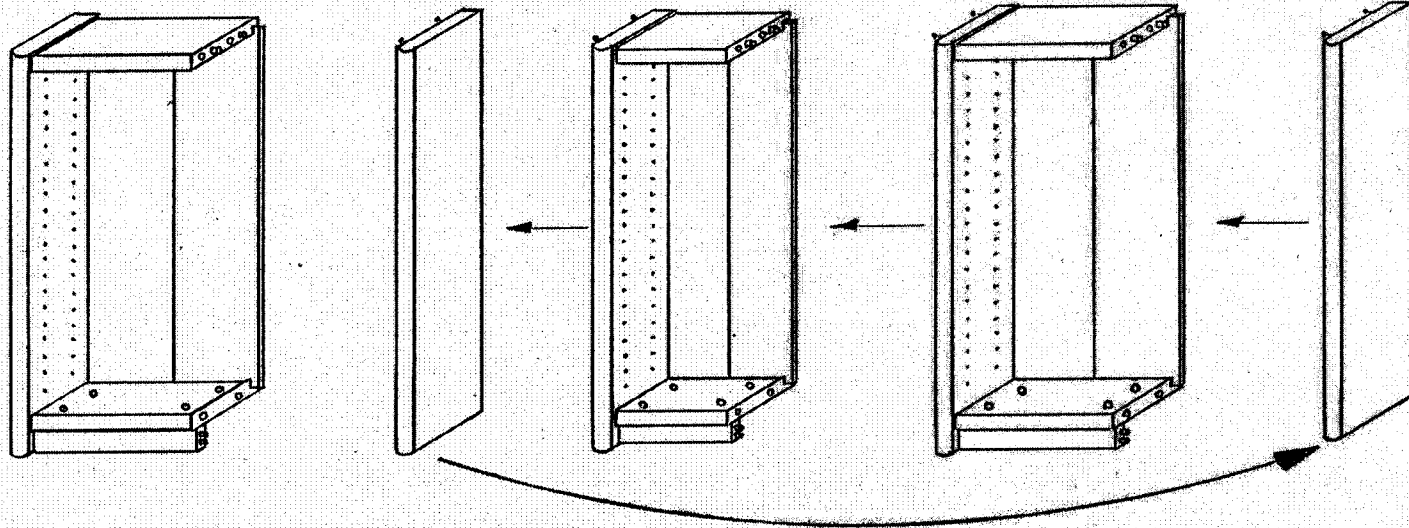

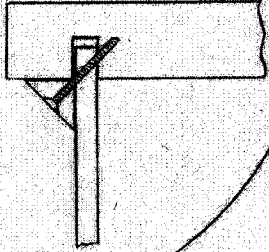

Programm "BOARD"

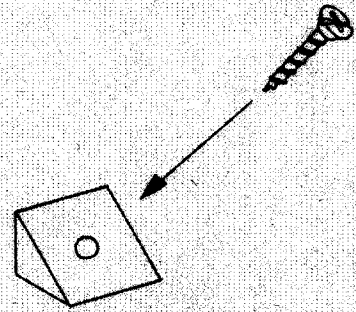
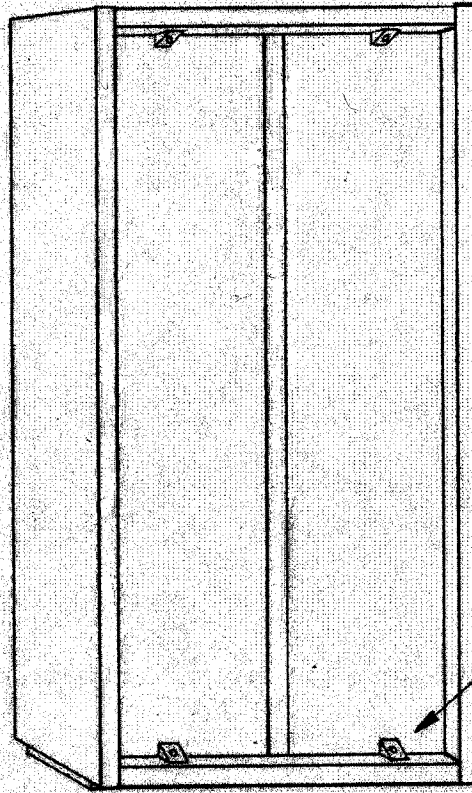

4 X