

Extended User's Guide



9231095
Issue 1

DECLARATION OF CONFORMITY

We, NOKIA CORPORATION declare under our sole responsibility that the product RH-37 is in conformity with the provisions of the following Council Directive: 1999/5/EC.

A copy of the Declaration of Conformity can be found from http://www.nokia.com/phones/declaration_of_conformity/.

CE 168

Copyright © 2004 Nokia. All rights reserved.

Reproduction, transfer, distribution or storage of part or all of the contents in this document in any form without the prior written permission of Nokia is prohibited.

Nokia, Nokia Connecting People, Xpress-on and Pop-Port are trademarks or registered trademarks of Nokia Corporation. Other product and company names mentioned herein may be trademarks or tradenames of their respective owners.

Nokia tune is a sound mark of Nokia Corporation.

US Patent No 5818437 and other pending patents. T9 text input software Copyright (C) 1997-2004. Tegic Communications, Inc. All rights reserved.



Includes RSA BSAFE cryptographic or security protocol software from RSA Security.



Java is a trademark of Sun Microsystems, Inc.

Nokia operates a policy of continuous development. Nokia reserves the right to make changes and improvements to any of the products described in this document without prior notice.

Under no circumstances shall Nokia be responsible for any loss of data or income or any special, incidental, consequential or indirect damages howsoever caused.

The contents of this document are provided "as is". Except as required by applicable law, no warranties of any kind, either express or implied, including, but not limited to, the implied warranties of merchantability and fitness for a particular purpose, are made in relation to the accuracy, reliability or contents of this document. Nokia reserves the right to revise this document or withdraw it at any time without prior notice.

The availability of particular products may vary by region. Please check with the Nokia dealer nearest to you.

Export Controls

This device may contain commodities, technology or software subject to export laws and regulations from the US and other countries. Diversion contrary to law is prohibited.

9231095 / Issue 1

Contents

FOR YOUR SAFETY	12
General information	14
About your device.....	14
Overview of the functions of the phone	14
Shared memory.....	16
Access codes.....	16
Security code (5 to 10 digits).....	16
PIN and PIN2 codes (4 to 8 digits), Module PIN and Signing PIN.....	16
PUK and PUK2 codes (8 digits).....	17
Barring password (4 digits).....	17
Wallet code (4 to 10 digits).....	17
Network services	18
Configuration settings service.....	18
Downloading content and applications.....	19
Nokia support on the Web	20
1. Getting started	21
Installing the SIM card and the battery	21
Charging the battery.....	23
Switching the phone on and off.....	24
Normal operating position	24
Changing the covers.....	25
Changing the grips	26
Creating cut-out covers.....	27
Changing the cut-out cover.....	27
Putting on a wrist strap	28

2. Your phone.....	29
Keys and connectors	29
Standby mode	30
Wallpaper.....	31
Screen saver.....	31
Power saving.....	32
Essential indicators.....	32
Keypad lock (Keyguard).....	34
3. Call functions.....	35
Making a call.....	35
Speed dialling a phone number.....	36
Answering or rejecting an incoming call	36
Call waiting	37
Options during a call.....	37
4. Writing text	39
Setting predictive text input on or off.....	39
Using predictive text input.....	39
Writing compound words.....	40
Using traditional text input	40
Tips for writing text.....	41
5. Using the menu.....	43
Accessing a menu function.....	43
List of menu functions.....	44
6. Menu functions	49
Messages	49
Text messages (SMS)	49
Writing and sending messages	50

Options for sending a message	51
Reading and replying to an SMS message or an SMS e-mail	52
Inbox and sent items folders	53
Templates	53
Saved items folder and My folders	54
Flash messages	54
Writing a flash message.....	54
Receiving a flash message.....	55
Multimedia messages (MMS).....	55
Writing and sending a multimedia message.....	56
Reading and replying to a multimedia message.....	58
Inbox, Outbox, Saved and Sent items folders	59
Multimedia messages memory full.....	60
Instant messages (Chat)	60
Entering the instant messaging menu	62
Connecting to and disconnecting from the instant messaging service	62
Starting an instant messaging conversation.....	63
Accepting or rejecting an invitation.....	64
Reading an instant message	64
Participating in a conversation.....	65
Editing your own settings.....	66
Contacts for instant messaging	66
Blocking and unblocking messages	67
Groups	67
Instant messaging settings	68
E-mail application	69
Writing and sending an e-mail.....	69
Downloading e-mails from your e-mail account.....	70

Reading and replying to an e-mail	71
Inbox and Other folders (Drafts, Archive, Outbox and Sent items)	72
Deleting e-mails	72
Voice messages	72
Info messages	73
Service commands.....	73
Deleting all messages from a folder.....	73
Message settings	74
Settings for text and SMS e-mail messages	74
Settings for multimedia messages	75
Settings for e-mail application	76
Common settings	78
Message counter.....	78
Call register.....	78
Recent calls lists	79
Counters and timers for calls, data and messages	80
Contacts.....	81
Selecting settings for contacts.....	81
Saving names and phone numbers (Add contact)	82
Saving multiple numbers or text items per name	82
Adding an image to a name or number in contacts.....	83
Searching for a contact.....	83
Deleting contacts.....	84
Editing or deleting details.....	85
My presence	85
Subscribed names.....	87
Adding contacts to the subscribed names.....	88
Viewing the subscribed names.....	88
Unsubscribing a contact	89

Copying contacts	89
Sending and receiving a business card.....	90
Speed dials.....	90
Voice dialling	91
Adding and managing voice tags.....	91
Making a call by using a voice tag	92
Info numbers and service numbers	92
My numbers	93
Caller groups.....	93
Settings.....	94
Profiles.....	94
Themes.....	95
Tone settings.....	95
Light settings	96
Personal shortcuts.....	96
Right selection key	96
Go to options.....	96
Voice commands	97
Display settings.....	97
Time and date settings.....	99
Call settings.....	100
Phone settings.....	101
Connectivity.....	103
(E)GPRS	103
(E)GPRS connection.....	104
(E)GPRS modem settings.....	104
Enhancement settings.....	105
Configuration settings	106
Security settings	107

Restore factory settings.....	108
Operator menu.....	108
Gallery.....	109
Media.....	111
Camera.....	111
Taking a photo or a video clip.....	111
Camera settings.....	112
Voice recorder.....	113
Recording.....	113
List of recordings.....	114
Organiser.....	114
Alarm clock.....	114
When the alarm time expires.....	114
Calendar.....	115
Making a calendar note.....	116
When the phone sounds an alarm for a note.....	116
To-do list.....	117
Notes.....	118
Synchronisation.....	118
Synchronising from your phone.....	118
Settings for the synchronisation from your phone.....	119
Synchronising from your compatible PC.....	120
Applications.....	120
Games and applications.....	120
Launching a game or an application.....	120
Options available for a game or an application.....	120
Downloading a game or an application.....	122
Game settings.....	123
Memory status for games and applications.....	123

Calculator.....	123
Countdown timer.....	124
Stopwatch.....	125
Wallet.....	126
Accessing the wallet menu	127
Saving card details.....	127
Personal notes.....	128
Creating a wallet profile	128
Wallet settings.....	129
Guidelines for paying for your purchases with the wallet	129
Services	130
Basic steps for accessing and using services.....	130
Setting up the phone for a service	131
Making a connection to a service.....	131
Browsing the pages of a service.....	132
Using the phone keys while browsing.....	132
Options while browsing.....	133
Direct calling	133
Disconnect from a service.....	134
Appearance settings of the browser	134
Cookies.....	135
Bookmarks	135
Receiving a bookmark.....	136
Downloading	136
Service inbox.....	136
Service inbox settings.....	137
The cache memory	137
Browser security	138
Security module.....	138

Certificates.....	139
Digital signature.....	140
SIM services.....	141
7. PC Connectivity.....	142
PC Suite.....	142
(E)GPRS, HSCSD and CSD.....	143
Using data communication applications.....	144
8. Battery information.....	145
Charging and Discharging.....	145
CARE AND MAINTENANCE.....	146
ADDITIONAL SAFETY INFORMATION.....	147

FOR YOUR SAFETY

Read these simple guidelines. Not following them may be dangerous or illegal. Read the complete user guide for further information.



SWITCH ON SAFELY

Do not switch the phone on when wireless phone use is prohibited or when it may cause interference or danger.



ROAD SAFETY COMES FIRST

Obey all local laws. Always keep your hands free to operate the vehicle while driving. Your first consideration while driving should be road safety.



INTERFERENCE

All wireless phones may be susceptible to interference, which could affect performance.



SWITCH OFF IN HOSPITALS

Follow any restrictions. Switch the phone off near medical equipment.



SWITCH OFF IN AIRCRAFT

Follow any restrictions. Wireless devices can cause interference in aircraft.



SWITCH OFF WHEN REFUELLING

Don't use the phone at a refuelling point. Don't use near fuel or chemicals.



SWITCH OFF NEAR BLASTING

Follow any restrictions. Don't use the phone where blasting is in progress.

**USE SENSIBLY**

Use only in the normal position as explained in the product documentation. Don't touch the antenna unnecessarily.

**QUALIFIED SERVICE**

Only qualified personnel may install or repair this product.

**ENHANCEMENTS AND BATTERIES**

Use only approved enhancements and batteries. Do not connect incompatible products.

**WATER-RESISTANCE**

Your phone is not water-resistant. Keep it dry.



**BACK-UP COPIES**

Remember to make back-up copies or keep a written record of all important information stored in your phone.

**CONNECTING TO OTHER DEVICES**

When connecting to any other device, read its user guide for detailed safety instructions. Do not connect incompatible products.

**EMERGENCY CALLS**

Ensure the phone is switched on and in service. Press  as many times as needed to clear the display and return to the start screen. Key in the emergency number, then press . Give your location. Do not end the call until given permission to do so.

General information

■ About your device

The wireless device described in this guide is approved for use on the EGSM 900, GSM 1800 and GSM 1900 network. Contact your service provider for more information about networks.

When using the features in this device, obey all laws and respect privacy and legitimate rights of others.



Warning: To use any features in this device, other than the alarm clock, the device must be switched on. Do not switch the device on when wireless device use may cause interference or danger.

Your device and its enhancements may contain small parts. Keep them out of the reach of small children.

For availability of approved enhancements, please check with your dealer. When you disconnect the power cord of any enhancement, grasp and pull the plug, not the cord.

■ Overview of the functions of the phone

The Nokia 3220 phone provides many functions that are practical for daily use, such as a calendar, a clock, an alarm clock, and a built-in camera. The camera can be used for recording video clips and taking pictures that you can, for example, attach as wallpaper in standby mode or as thumbnail pictures in [Contacts](#). See Camera on page 111. Personalise your phone with cut-out covers and with themes. See Changing the cut-out cover on page 27 and Themes on page 95. Also, a range of Nokia

Xpress-on™ covers and Nokia Xpress-on™ grips are available for your phone. To change the covers and grips, see Changing the covers on page 25 and Changing the grips on page 26.

Your phone supports

- EDGE (Enhanced Data rates for GSM Evolution), see (E)GPRS on page 103. EDGE is a radio interface modulation technique which increases GPRS data rates.
- A multimedia messaging service (MMS) and is able to send and receive multimedia messages composed of text, a picture, a sound clip and a video clip. You can save the pictures, ringing tones or themes for personalising your phone. See Multimedia messages (MMS) on page 55.
- xHTML browser that enables you to retrieve more colourful and richer graphical content from web servers and to view it. See Services on page 130.
- An e-mail application to receive, read and send e-mails. See E-mail application on page 69.
- Presence-enhanced contacts that enables you to conveniently share your availability information with your colleagues, family and friends. See My presence on page 85.
- Instant messages, which is a way of sending short text messages that are delivered instantly to online users. See Instant messages (Chat) on page 60.
- Polyphonic sound (MIDI) that consists of several sound components played at the same time. The phone has sound components from over 128 instruments, it can play up to 24 instruments at the same time. Polyphonic sounds are used in ringing tones and message alert tones. The phone supports Scalable Polyphonic MIDI (SP-MIDI) format.
- Java 2 Micro Edition, J2ME™, and includes some Java applications and games that have been specially designed for mobile phones. You can download new applications and games to your phone, see Applications on page 120.

Shared memory

The phone has three different memories. The following features in this device may share the first memory: contacts, text messages, instant messages and SMS e-mails, voice tags, calendar and notes. The second shared memory is used by multimedia messages, files stored in Gallery and configuration settings. The third shared memory is used by e-mail application, Java games and applications. Use of one or more of these features may reduce the memory available for the remaining features sharing the same memory. For example, saving many Gallery items may use all of the available memory in the second memory. Your device may display a message that the memory is full when you try to use a shared memory feature. In this case, delete some of the information or entries stored in the corresponding shared memory before continuing.

■ Access codes

Security code (5 to 10 digits)

The security code helps to protect your phone against unauthorised use. The pre-set code is 12345. Change the code, and keep the new code secret and in a safe place separate from your phone. To change the code, and to set the phone to request the code, see Security settings on page 107.

If you key in an incorrect security code five times in succession, the phone ignores further entries of the code. Wait for 5 minutes and key in the code again.

PIN and PIN2 codes (4 to 8 digits), Module PIN and Signing PIN

- The PIN (Personal Identification Number) code helps to protect your SIM card against unauthorised use. The PIN code is usually supplied with the SIM card. Set the phone to request the PIN code each time the phone is switched on, see Security settings on page 107.

- The PIN2 code may be supplied with the SIM card and is required to access some functions, such as call counters.
- The module PIN is required to access the information in the security module. See Security module on page 138. The module PIN is supplied with the SIM card if the SIM card has a security module in it.
- The signing PIN is required for the digital signature. See Digital signature on page 140. The signing PIN is supplied with the SIM card if the SIM card has a security module in it.

If you key in an incorrect PIN code three times in succession, the phone may display *PIN blocked* or *PIN code blocked*, for example, and ask you to enter the PUK code.

PUK and PUK2 codes (8 digits)

The PUK (Personal Unblocking Key) code is required to change a blocked PIN code. The PUK2 code is required to change a blocked PIN2 code.

If the codes are not supplied with the SIM card, contact your local service provider for the codes.

Barring password (4 digits)

The barring password is required when using the *Call barring service*, see Security settings on page 107. You can obtain the password from your service provider.

Wallet code (4 to 10 digits)

The wallet code is required to access the wallet services. If you key in an incorrect wallet code three times in succession, the wallet application is blocked for 5 minutes. The next three incorrect entries of the code will double the time. For further information, see Wallet on page 126.

■ Network services

To use the phone you must have service from a wireless service provider. Many of the features in this device depend on features in the wireless network to function. These Network Services may not be available on all networks or you may have to make specific arrangements with your service provider before you can utilize Network Services. Your service provider may need to give you additional instructions for their use and explain what charges will apply. Some networks may have limitations that affect how you can use Network Services. For instance, some networks may not support all language-dependent characters and services.

Your service provider may have requested that certain features be disabled or not activated in your device. If so, they will not appear on your device menu. Contact your service provider for more information.

This device supports WAP 2.0 protocols (HTTP and SSL) that run on TCP/IP protocols. Some features of this device, such as multimedia messages, e-mail application, instant messages, presence service, Java games and applications and Internet services require network support for these technologies.

Configuration settings service

To use some of the network services, such as mobile Internet services, MMS, Instant messages, E-Mail application, or Synchronisation, your phone needs the correct configuration settings. You may receive the settings directly as a configuration message and you need to save the settings on your phone. The service provider may provide a PIN that is needed to save the settings. For more information on the availability of the settings, contact your network operator, service provider or nearest authorised Nokia dealer.

When you have received a configuration message *Configuration sett. received* is displayed. To view the received settings, press **Show**.

- To save the received settings, press **Save**. If the phone asks *Enter settings' PIN*; key in the PIN code for the settings and press **OK**. Set these settings as the default or not. For availability of the PIN code, contact the service provider that supplies the settings.
- To discard the received settings, press **Discard**.

To view and edit the settings see Configuration settings on page 106.

■ Downloading content and applications

You may be able to download new content (for example images and video clips) and applications into the phone (network service).

1. Select the download function for example in the *Collection* and *Gallery* menus. To access the download function, see the respective menu descriptions.

A list of bookmarks is shown. Select *More bookmarks* if you want to view the bookmarks available in the *Services* menu.

2. Select the bookmark of the browser page that you want to access. If the connection fails, change the active set of connection settings in the *Services* menu and try the connection again. Follow the instructions provided by the service.

For the availability of different services, pricing and tariffs, contact your network operator and/or the service provider.

Your device may have some bookmarks loaded for sites not affiliated with Nokia. Nokia does not warrant or endorse these sites. If you choose to access them, you should take the same precautions, for security or content, as you would with any Internet site.

■ Nokia support on the Web

Check <www.nokia.com/support> or your local Nokia Web site for the latest version of this guide, additional information, downloads, and services related to your Nokia product.

1. Getting started

■ Installing the SIM card and the battery

Keep all SIM cards out of the reach of small children. For availability and information on using SIM card services, contact your SIM card vendor. This may be the service provider, network operator, or other vendor.

Always switch the device off and disconnect the charger before removing the battery.

1. To remove the back cover of the phone:

Push the back cover release button (1) and gently prise the back cover away from the phone beginning at the bottom of the phone (2).

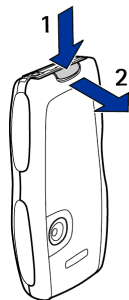

2. Remove the battery by lifting it as shown. Insert the SIM card into the SIM card holder until it snaps into position. Make sure that the SIM card is properly inserted and that the golden contact area on the card is facing downwards.

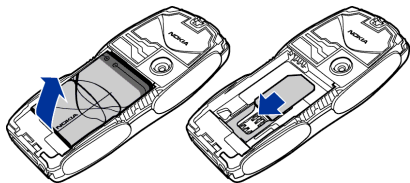

To remove the SIM card press the card release (1) and slide the SIM card towards the top of the phone (2).

3. Replace the battery. Observe the contacts of the battery

4. Align the top of the back cover with the top of the phone (1), press the bottom of the back cover to lock it (2).

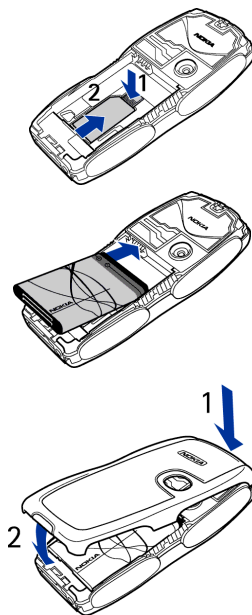

Getting started

■ Charging the battery



Warning: Use only batteries, chargers, and enhancements approved by Nokia for use with this particular model. The use of any other types may invalidate any approval or warranty, and may be dangerous.

Check the model number of any charger before use with this device. This device is intended for use when supplied with power from ACP-7, ACP-8, ACP-12, LCH-9 or LCH-12 chargers.

1. Connect the lead from the charger to the socket on the bottom of your phone.
2. Connect the charger to an AC wall socket.

The text *Charging* is displayed briefly if the phone is switched on. If the battery is completely empty, it may take a few minutes before the charging indicator appears on the display or before any calls can be made.

You can use the phone while the charger is connected.

The charging time depends on the charger and the battery used. For example, charging a battery with the ACP-12 charger takes approximately 1 hour and 20 minutes while the phone is in standby mode.

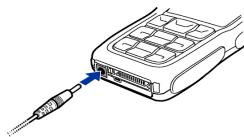

■ Switching the phone on and off



Warning: Do not switch the phone on when wireless phone use is prohibited or when it may cause interference or danger.

Press and hold the power key as shown.

Note that if the phone displays *Insert SIM card* even though the SIM card is properly inserted, or *SIM card not supported*, contact your network operator or service provider. Your phone does not support 5-Volt SIM cards and the card may need to be changed.

- If the phone asks for a PIN code, key in the PIN code (for example, displayed as ****), and press **OK**.

See also *PIN code request* in Security settings on page 107 and Access codes on page 16.

- If the phone asks for a security code, key in the security code (for example, displayed as *****), and press **OK**.

See also Access codes on page 16.



■ Normal operating position

Your phone has an internal antenna. Use the phone only in its normal operating position as shown.

Note: As with any other radio transmitting device, do not touch the antenna unnecessarily when the device is switched on. Contact with the antenna affects call quality and may cause the device to operate at a higher power level than otherwise needed. Avoiding contact with the antenna area when operating the device optimises the antenna performance and the battery life.

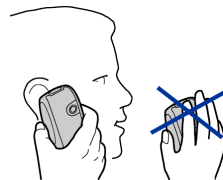

■ Changing the covers



Note: Before removing the cover, always switch off the power and disconnect the charger and any other device. Avoid touching electronic components while changing the covers. Always store and use the device with the covers attached.

1. Remove the back cover from the phone as described on page 21.
2. Remove the front cover from the phone. For this gently prise the front cover away from the phone beginning at the top of the phone (1) and detach the front cover (2).
3. Remove the key mat from the front cover by taking it out gently.

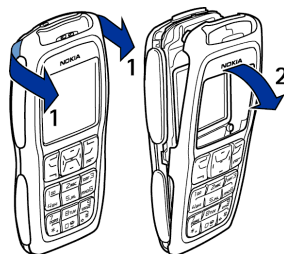

- Place the key mat in the new front cover (3).
- Replace the front cover by pressing it gently onto the phone until it snaps into position (4).
- Align the top of the back cover with the top of the phone (5), press the bottom of the back cover to lock it (6).

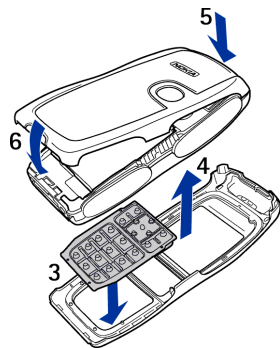

■ Changing the grips

- Remove the covers from the phone. See Changing the covers on page 25.
- To remove the grips slide them to the top of the phone (1), then remove the grip (2).
- Replace the grips as shown.
- Replace the covers of the phone. See Changing the covers on page 25.

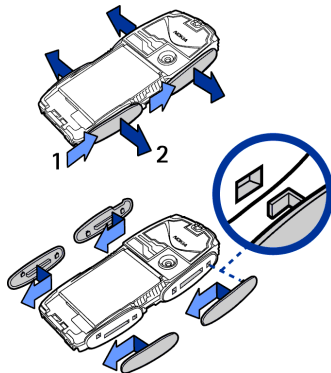

■ Creating cut-out covers

Use the plastic stencil to create a cut-out cover using your own design.



Note: Use normal, plain paper as found in standard printers or use a photo print that is not thicker than 0.3 mm. To avoid affecting the antenna performance the material must not contain metal particles.

1. Place the stencil in the correct position and draw the outline.
2. Carefully cut out your new cut-out cover.

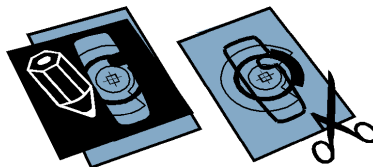

■ Changing the cut-out cover

1. Remove the back cover from the phone. See Changing the covers on page 25.
2. Remove the cut-out cover from the back cover.
3. Place the new cut-out cover into the back cover by sliding the cut-out cover under the two guides at the bottom (1) and then under the guide at the top (2).
4. Replace the back cover.

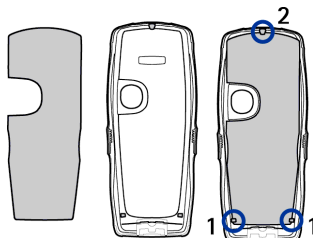

■ Putting on a wrist strap

Remove the back cover and thread the strap as shown in the picture and tighten it. Replace the back cover.

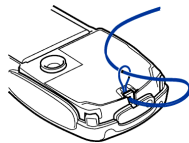

Getting started

2. Your phone

■ Keys and connectors

1. Power key

Switches the phone on and off. When the keypad is locked, pressing the power key briefly turns the phone's display lights on for approximately 15 seconds.



2. Earpiece

3. Loudspeaker





4. Selection keys and , middle selection key



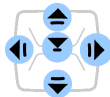
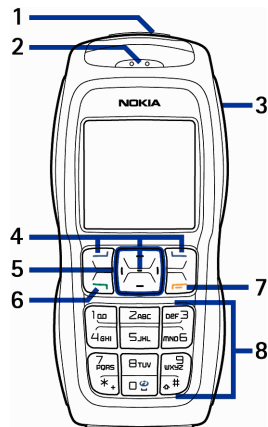

The function of these keys depends on the guiding text shown on the display above the keys. See Standby mode on page 30.

5. 4-way scroll keys , , ,

Enables navigation through names, phone numbers, menus or settings. The 4-way navigation key is also used to move the cursor up and down, left and right when writing text, using the calendar, and in some game applications. Pressing the key briefly in the middle  selects the menu item or confirms a selection. In standby mode, pressing  opens the *Standard photo* menu, pressing  opens the *Create message* menu,



and pressing  opens the *Calendar* menu. During a call pressing  and  adjusts the volume. In standby mode and during a call, pressing  opens the contacts list.

6.  dials a phone number, and answers a call. In standby mode, it shows the list of the most recently called numbers.
7.  ends an active call. **Exits from any function.**
8.  -  enter numbers and characters.
 *+ and +# are used for various purposes in different functions.
9. Charger connector
10. Pop-Port™ connector used, for example, for headsets and the data cable.
11. Camera lens

■ Standby mode

When the phone is ready for use, and you have not keyed in any characters, the phone is in standby mode.

1. Shows the name of the network or the operator logo to indicate in which cellular network the phone is currently being used.
2. Shows the signal strength of the cellular network at your current location. The higher the bar, the stronger the signal.
3. Shows the battery charge level. The higher the bar, the more power in the battery

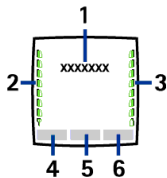
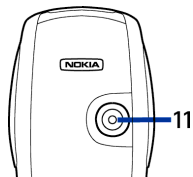
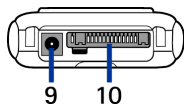

4. The left selection key in standby mode is **Go to**.

Press **Go to** to view the functions in your personal shortcut list. Select a function to activate it.

Press **Options** and select

- **Select 'Go to' options** to view the list of available functions that you can add.
Scroll to the desired function and press **Mark** to add it to the shortcut list. To remove a function from the list, press **Unmark**.
- **Organise 'Go to' options** to rearrange the functions on your personal shortcut list. Select the desired function and press **Move**, then select where you want to move the function.

See also Go to options on page 96.

5. The middle selection key in standby mode is **Menu**.

6. The right selection key in standby mode is **Names** to access the **Contacts** menu or another shortcut to a function you can select. See Personal shortcuts on page 96. Or the key has an operator-specific name to access an operator-specific web site.

See also Essential indicators on page 32.

Wallpaper

You can set your phone to display a background picture, wallpaper, when the phone is in standby mode. See Display settings on page 97.

Screen saver

You can set your phone to display a screen saver, when the phone is in standby mode. See Display settings on page 97.

Power saving

For power saving, a digital clock view overwrites the display when no phone function has been used for a certain period of time. Press any key to deactivate the screen saver.

If you have not set the time, 00:00 is displayed. To set the time, see [Time and date settings](#) on page 99.

In addition you can set a screen saver from [Gallery](#). See [Display settings](#) on page 97.

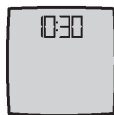

Essential indicators

 You have received one or several text, picture messages or multimedia messages. See [Reading and replying to an SMS message or an SMS e-mail](#) on page 52 or [Reading and replying to a multimedia message](#) on page 58.

 The phone has registered a missed call. See [Call register](#) on page 78.















Your phone is connected to the instant messages service and the availability status is online or offline, respectively. See [Connecting to and disconnecting from the instant messaging service](#) on page 62.

 You have received one or several instant messages and you are connected to the instant messages service. See [Connecting to and disconnecting from the instant messaging service](#) on page 62.

 The phone's keypad is locked. See [Keypad lock \(Keyguard\)](#) on page 34.

 The phone does not ring for an incoming call or text message when [Incoming call alert](#) is set to *Off* and [Message alert tone](#) is set to *Off*. See [Tone settings](#) on page 95.

-  The alarm clock is set to *On*. See Alarm clock on page 114.
-  The countdown timer is running. See Countdown timer on page 124.
-  The stopwatch is running in the background. See Stopwatch on page 125.
-  When the (E)GPRS connection mode *Always online* is selected and the (E)GPRS service is available, the indicator is shown on the top left of the display. Refer to (E)GPRS connection on page 104.
-  When the (E)GPRS connection is established, the indicator is shown on the top left of the display. Refer to (E)GPRS connection on page 104 and Browsing the pages of a service on page 132.
-  The (E)GPRS connection is suspended (on hold), for example if there is an incoming or outgoing call during the (E)GPRS dial-up connection. The indicator is shown on the top right of the display.
-  All your calls are diverted to another number, *Divert all voice calls*. If you have two phone lines, the divert indicator for the first line is  and for the second line . See Call settings on page 100.
- 1 or 2** If you have two phone lines, the indicator displays the selected phone line. See Call settings on page 100.
-  The loudspeaker has been activated, see Options during a call on page 37.
-  Calls are limited to a closed user group. See Security settings on page 107.
-  The timed profile is selected. See Profiles on page 94.



A headset, handsfree, loopset or music stand is connected to the phone.

To set the phone to show the time and date in standby mode, see Time and date settings on page 99.

■ Keypad lock (Keyguard)

You can lock the keypad to prevent the keys being accidentally pressed, for example, when your phone is in your handbag.

- Locking the keypad

In standby mode, press **Menu** and then ***+** within 1.5 seconds.

- Unlocking the keypad

Press **Unlock** and then ***+** within 1.5 seconds.

To answer a call when the keyguard is on, press **1**. During a call, the phone can be operated normally. When you end or reject the call, the keypad will automatically be locked.

For *Automatic keyguard*, see Phone settings on page 101.

For locking the keypad during a call, see Options during a call on page 37.



When the keypad lock is on, calls still may be possible to the official emergency number programmed into your device. Key in the emergency number and press **1**.

3. Call functions

■ Making a call

1. Key in the phone number, including the area code. If you key in an incorrect character, press **Clear** to delete it.

For international calls, press ***+** twice for the international prefix (the + character replaces the international access code) and then key in the country code, the area code without the leading 0, if necessary, and the phone number.



2. Press  to call the number.
3. Press  to end the call or to cancel the call attempt.

See also Options during a call on page 37.



Making a call using the contacts

To search for a name/phone number that you have saved in *Contacts*, see Searching for a contact on page 83. Press  to call the number.

Last number redialling

In standby mode, press  once to access the list of up to 20 numbers you last called or attempted to call. Scroll to the number or name that you want, and press  to call the number.

Calling your voice mailbox

In standby mode, press and hold  or press  and .



If the phone asks for the voice mailbox number, key it in and press **OK**. See also Voice messages on page 72.

Speed dialling a phone number

Before you can use speed dialling, assign a phone number to one of the speed-dialling keys, from ZABC to WXYZ, see Speed dials on page 90. Call the number in either of the following ways:

- Press the speed-dialling key that you want and then press .
- If *Speed dialling* is set to on, press and hold a speed-dialling key until the call is started. See Call settings on page 100.

■ Answering or rejecting an incoming call

Press  to answer an incoming call and press  to end the call.

Press  to reject an incoming call.

If you press **Silence**, only the ringing tone is muted. Then either answer or reject the call.



If a compatible headset supplied with the headset key is connected to the phone, you can answer and end a call by pressing the key.



Tip: If the *Divert if busy* function is activated to divert the calls, for example to your voice mailbox, rejecting an incoming call will also divert the call. See Call settings on page 100.

Note that when somebody is calling you, the phone shows the caller's name, phone number or the text *Private number* or *Call*. If more than one name is found in *Contacts* with the same last seven digits of the phone number as the caller's number, only the phone number will be displayed, if this is available. The phone may display an incorrect name, if the caller's number is not saved in *Contacts* but there is another name saved with the same last eight digits in the phone number as in the phone number of the caller.

Call waiting

During a call, press  to answer the waiting call. The first call is put on hold. Press  to end the active call.

To activate the *Call waiting* function, see Call settings on page 100.

■ Options during a call

Many of the options that you can use during a call are network services. For availability, contact your network operator or service provider.

Press **Options** during a call for some of the following options:

- *Mute* or *Unmute*, *Contacts*, *Menu*, *Record*, and the network services *Answer* and *Reject*, *Hold* or *Unhold*, *New call*, *End call*, *End all calls*.
- *Lock keypad* to activate the keypad lock.
- *Send DTMF* to send DTMF (Dual Tone Multi-Frequency) tone strings, for example, passwords or bank account numbers (network service). The DTMF system is used by all touch-tone telephones. Key in the DTMF string or search for it in *Contacts* and press **DTMF**. Note that you can key in the wait character w and the pause character p by repeatedly pressing ***+.**
- *Swap* to switch between the active call and the call on hold, *Transfer* to connect a call on hold to an active call, and disconnect yourself from both calls (network services).
- *Conference* to call another party and invite them into the call (network service).
- *Private call* to have a private conversation with one participant in a conference call (network service).

- *Auto volume on* or *Auto volume off*. Automatic volume controls the earpiece volume level according to the environment noise level.
- *Loudspeaker* to use the integrated loudspeaker during a call to have the handsfree function of your phone.













Note: Do not hold the device near your ear when the loudspeaker is in use, because the volume may be extremely loud.

To activate/deactivate the loudspeaker, select *Loudspeaker/Handset* or press *Loudsp./Normal*. The loudspeaker is automatically deactivated when you end the call or call attempt or connect the handsfree unit or headset to the phone.

If you have connected a compatible handsfree unit or the headset to the phone, *Handset* in the options list is replaced with *Handsfree* or *Headset* and the selection key *Normal* with *Handsf.* or *Heads.*, respectively.

4. Writing text

You can key in text, for example, when writing messages, using traditional or predictive text input.



When you are writing text, predictive text input is indicated by  and traditional text input by  at the top left of the display. The character case is indicated by , , or  next to the text input indicator. You can change the character case by pressing  . The number mode is indicated by , and you can change between the letter and number mode by pressing and holding  .

■ Setting predictive text input on or off

When writing text, press **Options** and select *Dictionary*.





- To set predictive text input on, select a language in the dictionary options list. Predictive text input is only available for the languages on the list.
- To revert to traditional text input, select *Dictionary off*.



Tip: To quickly set predictive text input on or off when writing text, press   twice, or press and hold **Options**.

■ Using predictive text input



You can key in any letter with a single keypress. Predictive text input is based on a built-in dictionary to which you can also add new words.

1. Start writing a word using the keys   to  . Press each key only once for a single letter. The word changes after each keystroke.



Example: To write *Nokia* when the English dictionary is selected, press **mnoБ**, **mnoБ**, **5JKL**, **4GHI** and **ZABC**.

For more instructions on writing text, see *Tips for writing text* on page 41.

- When you have finished writing the word and it is correct, confirm it by adding a space with   or by pressing any of the scroll keys. Pressing a scroll key also moves the cursor.

If the word is not correct, press ***+** repeatedly or press **Options** and select *Matches*. When the word that you want appears, confirm it.

If the ? character is displayed after the word, the word you intended to write is not in the dictionary. To add the word to the dictionary, press **Spell**, key in the word (traditional text input is used) and press **Save**. When the dictionary becomes full, the new word replaces the oldest one that was added.

- Start writing the next word.

Writing compound words

Key in the first part of the word and confirm it by pressing . Write the last part of the word and confirm the word.

Using traditional text input

Press a number key, **ZABC** to **wxyz9**, repeatedly until the desired character appears. Not all characters available under a number key are printed on the key. The characters available depend on the language selected in the *Phone language* menu, see *Phone settings* on page 101.



- If the next letter you want is located on the same key as the present one, wait until the cursor appears, or press any of the scroll keys and then key in the letter.

- The most common punctuation marks and special characters are available under the number key *+.

For more instructions on writing text, see Tips for writing text on page 41.

■ Tips for writing text

The following functions may also be available for writing text:

- To insert a space, press  .
- Move the cursor to the left, right, down or up with the navigation key.
- To insert a number while in letter mode, press and hold the desired number key.
- To delete a character to the left of the cursor, press **Clear**. Press and hold **Clear** to delete the characters more quickly.

To delete all the characters at once when writing a message, press **Options** and select *Clear text*.

- To insert a word when using predictive text input, press **Options** and select *Insert word*. Write the word using traditional text input and press **Save**. The word is also added to the dictionary.
- To insert a special character when using traditional text input, press *+, or when using predictive text input, press and hold *+, or press **Options** and select *Insert symbol*.

Press any of the scroll keys to scroll to a character and press **Use** to select the character.

You can also scroll to a character by pressing ZABC, ЧБHI, мноБ or БТУV, and select the character by pressing СЖKL.

- To insert a smiley when using traditional text input, press *+ twice, or when using predictive text input, press and hold *+ and press *+ again, or press **Options** and select *Insert smiley*.

Press any of the scroll keys to scroll to a smiley and press **Use** to select the smiley.

You can also scroll to a character by pressing Z_{ABC}, 4_{GHI}, m_{NO} or B_{TUV}, and select the character by pressing S_{JHL}.

The following options are available when writing text messages:

- To insert a number while in letter mode, press **Options** and select *Insert number*. Key in the phone number or search for it in *Contacts* and press **OK**.
- To insert a name from *Contacts*, press **Options** and select *Insert contact*. To insert a phone number or a text item attached to the name, press **Options** and select *View details*.

5. Using the menu

The phone offers you an extensive range of functions, which are grouped into menus. Most of the menu functions are provided with a brief help text. To view the help text, scroll to the menu function you want and wait for 15 seconds. To exit the help text, press **Back**. See Phone settings on page 101.

■ Accessing a menu function

1. To access the menu, press **Menu**.
2. Scroll with ▲ or ▼ through the menu (or with any of the scroll keys if the grid menu view is selected) and select, for example, *Settings* by pressing **Select**. To change the menu view, see *Menu view* in Display settings on page 97.
3. If the menu contains submenus, select the one that you want, for example *Call settings*.
4. If the selected submenu contains further submenus, repeat step 3. Select the next submenu, for example *Anykey answer*.
5. Select the setting of your choice.
6. Press **Back** to return to the previous menu level, and **Exit** to exit the menu.

List of menu functions

- Messages



1. Create message
 1. Text message
 2. Multimedia msg.
 3. Flash message
2. Inbox
3. Outbox
4. Sent items
5. Saved items
 1. Text messages
 2. Multimedia msgs.
6. Instant messages
 1. Login
 2. Saved convers.
 3. Connect. settings
7. E-mail
 1. Create e-mail
 2. Retrieve
 3. Disconnect
 4. Inbox
 5. Other folders

8. Voice messages

1. Listen to voice messages
2. Voice mailbox number

9. Info messages

1. Info service
2. Topics
3. Language
4. Info topics saved on SIM card
5. Read¹

10. Service commands

11. Delete messages

12. Message settings

1. Text messages
2. Multimedia msgs.
3. E-mail messages
4. Other settings

13. Message counter

- Call register



1. Missed calls
2. Received calls
3. Dialed numbers

1. This menu is shown only if any info messages are received.

4. Delete recent call lists
 1. All
 2. Missed
 3. Received
 4. Dialed
5. Call duration
 1. Last call duration
 2. Received calls' duration
 3. Dialed calls' duration
 4. All calls' duration
 5. Clear timers
6. GPRS data counter
 1. Data sent in last session
 2. Data received in last session
 3. All sent data
 4. All received data
 5. Clear counters
7. GPRS connection timer
 1. Duration of last session
 2. Duration of all sessions
 3. Clear timers

- **Contacts**
 1. Search
 2. Add new contact
 3. Delete
 4. My presence
 5. Subscribed names
 6. Copy
 7. Settings
 1. Memory in use
 2. Contacts view
 3. Memory status
 8. Speed dials
 9. Voice tags
 10. Info numbers¹
 11. Service numbers¹
 12. My numbers²
 13. Caller groups²



1. Shown if supported by your SIM card. For availability, contact your network operator or service provider.
2. If Info numbers, Service numbers or both are not supported, the number of this menu item changes accordingly.

- Settings



1. Profiles

1. General
2. Silent
3. Meeting
4. Outdoor
5. My style 1
6. My style 2

2. Themes

1. Select theme
2. Theme downloads

3. Tone settings

1. Incoming call alert
2. Ringing tone
3. Ringing volume
4. Vibrating alert
5. Message alert tone
6. Instant message alert tone
7. Keypad tones
8. Warning tones
9. Alert for

4. Light settings

1. Light sequences

5. Personal shortcuts

1. Right selection key

2. Select 'Go to' options

3. Organise 'Go to' options

4. Voice commands

6. Display settings

1. Wallpaper
2. Screen saver
3. Colour schemes
4. Menu view
5. Operator logo

7. Time and date settings

1. Clock
2. Date
3. Auto-update of date & time

8. Call settings

1. Automatic volume control
2. Call divert
3. Anykey answer
4. Automatic redial
5. Speed dialling
6. Call waiting
7. Summary after call
8. Send my caller ID
9. Line for outgoing calls¹

9. Phone settings

1. Phone language

1. For availability, contact your network operator or service provider.

- 2. Automatic keyguard
- 3. Cell info display
- 4. Welcome note
- 5. Operator selection
- 6. Confirm SIM service actions
- 7. Help text activation
- 8. Start-up tone
- 10.Connectivity
 - 1. GPRS
- 11.Enhancement settings¹
 - 1. Headset
 - 2. Handsfree
 - 3. Loopset
- 12.Configuration settings
 - 1. Default configuration sett.ings
 - 2. Activate default in all applications
 - 3. Preferred access point
 - 4. Personal configuration settings
- 13.Security settings
 - 1. PIN code request
 - 2. Call barring service
 - 3. Fixed dialling
 - 4. Closed user group
 - 5. Security level
- 6. Access codes
- 14.Restore factory settings
- **Operator menu**²
- **Gallery**
 - 1. Images
 - 2. Video clips
 - 3. Themes
 - 4. Graphics
 - 5. Tones
 - 6. Recordings
- **Media**
 - 1. Camera
 - 2. Voice recorder
- **Organiser**
 - 1. Alarm clock
 - 1. Alarm time
 - 2. Repeat alarm



1. This menu is shown only if the phone is or has been connected to a compatible enhancement available for the phone.
 2. If this menu is not shown the subsequent menu numbers changes accordingly. The name depends on the network operator.

3. Alarm tone
2. Calendar
3. To-do
4. Notes
5. Synchronisation

- Applications

1. Games
 1. Select game
 2. Game downloads
 3. Memory
 4. App. settings
2. Collection
 1. Select application
 2. App. downloads
 3. Memory
3. Extras
 1. Calculator
 2. Countdown timer
 3. Stopwatch
 4. Wallet



- Services

1. Home
2. Bookmarks
3. Download links
 1. Tone downloads
 2. Graphic downloads
 3. Game downloads
 4. Video downloads
 5. Theme downloads
 6. App. downloads
4. Last web addr.
5. Service inbox
6. Settings
 1. Configuration settings
 2. Appearance settings
 3. Security settings
 4. Service inbox settings
7. Go to address
8. Clear the cache

- SIM services¹



1. Only shown if supported by your SIM card. The name and contents vary depending on the SIM card.

6. Menu functions

■ Messages

The message services can only be used if they are supported by your network or your service provider.



You can read, write, send and save text, multimedia and SMS e-mail messages (network services). All messages are organised into folders.

To select the font size for reading and writing messages, press **Menu**, and select *Messages*, *Message settings*, *Other settings* and *Font size*.



Note: When sending messages, your phone may display the words *Message sent*. This is an indication that the message has been sent by your device to the message centre number programmed into your device. This is not an indication that the message has been received at the intended destination. For more details about messaging services, check with your service provider.

Text messages (SMS)

Using the SMS (Short Message Service) your phone can send and receive multi-part messages, which consist of several ordinary text messages (network service). Invoicing may be based on the number of ordinary messages that are required for a multi-part message. This may affect the invoicing for the message.

Before you can send a message, you need to save some message settings. See Settings for text and SMS e-mail messages on page 74.

You can also send and receive text messages that contain pictures. A picture message can be a multi-part message.



Note: Only devices that offer picture message features can receive and display picture messages.

The text messages function uses shared memory, see [Shared memory](#) on page 16.

Writing and sending messages

Your device supports the sending of text messages beyond the normal 160-character limit. If your message exceeds 160 characters, it will be sent as a series of two or more messages. The number of available characters / the current part number of a multi-part message are shown on the top right of the display, for example 120/2. Note that using special (Unicode) characters such as ã, â, á, ì take up more space.

1. Press **Menu**, and select *Messages*, *Create message* and *Text message*.



Tip: To start writing messages quickly, press **Left Arrow** in standby mode.

2. Key in a message. See [Writing text](#) on page 39. To insert text templates or a picture into the message, see [Templates](#) on page 53. Each picture message comprises several text messages. Therefore, sending one picture message may cost more than sending one text message.
3. To send the message, press **Send** or **Right Arrow**.

The messages that you have sent will be saved in the *Sent items* folder if the setting *Save sent messages* is set to *Yes*. See [Settings for text and SMS e-mail messages](#) on page 74. Text messages are indicated with

4. Enter the recipient's phone number or search for the phone number in *Contacts*. Press **OK** to send the message.

Options for sending a message

After you have written a message, press **Options** and select *Sending options*.

- To send a message to several recipients, select *Send to many*. When you have sent the message to everyone you want to send it to, press **Done**. Note that a separate message is sent to each of the recipients.
- To send a message as an SMS e-mail (network service), select *Send as e-mail*.

Key in the recipient's e-mail address or search for it in *Contacts* and press **OK**. If you wish, you can key in a subject for the SMS e-mail and press **OK**.

Key in the e-mail message. See Writing text on page 39. The total number of characters that you can key in is shown on the top right of the display. The e-mail address and subject are included in the total number of characters.

See also Templates on page 53. Pictures cannot be inserted.

To send the SMS e-mail, press **Send**. If you have not saved the settings for sending SMS e-mails, the phone asks for the number of the e-mail server.

Press **OK** to send the e-mail.

- To send a message using a message profile, select *Sending profile* and then the desired message profile.

To define a message profile, see Settings for text and SMS e-mail messages on page 74.

Reading and replying to an SMS message or an SMS e-mail

When you have received a message or an SMS e-mail, the indicator  and the number of new messages followed by *messages received* are shown.

The blinking  indicates that the message memory is full. Before you can receive new messages, delete some of your old messages in the *Inbox* folder.

1. Press **Show** to view the new message, or press **Exit** to view it later.

Reading the message later:

Press **Menu**, and select *Messages* and *Inbox*.

2. If more than one message has been received, select the one that you want to read. An unread text message or SMS e-mail is indicated by .

Options while reading the message:

Press **Options** and select an option, for example, to delete, forward or edit the message as a text message or an SMS e-mail, rename the message you are reading or to move it to another folder.

Select *Copy to calendar* to copy text at the beginning of the message to your phone's calendar as a reminder note for the current day.

Select *Message details* to view, if available, the sender's name and phone number, the message centre used, and the date and time of receipt.

Select *Use detail* to extract numbers, e-mail addresses and website addresses from the current message.



Tip: While reading a message, press the  key to extract numbers, e-mail addresses and website addresses from the current message.

When reading a picture message, select *Save picture* to save the picture in the *Templates* folder.

3. Select **Reply** and the message type to reply to a message.

When replying to an SMS e-mail, confirm or edit the e-mail address and subject first. Then write your reply message.

4. To send the message, press **Send**, and press **OK** to send the message to the displayed number.



Inbox and sent items folders

The phone saves incoming text and multimedia messages in the *Inbox* folder.

Sent text messages are saved in the *Sent items* folder.

Text messages that you wish to send later can be saved in the *Saved text msgs.*, *My folders* or *Templates* folder.

Templates

Your phone includes text templates, indicated by , and picture templates, indicated by .

To access the template list, press **Menu**, and select *Messages*, *Saved items*, *Text messages* and *Templates*.

- To insert a text template into the message or the SMS e-mail that you are writing or replying to, press **Options**. Select *Use template* and select the template that you want to insert.
- To insert a picture into the text message that you are writing or replying to, press **Options**. Select *Insert picture* and select a picture to view it. Press **Insert** to insert the picture into your message. The  indicator in the header of the message indicates that a picture has been attached. The number of characters that you can enter in a message depends on the size of the picture.

To view the text and the picture together before sending the message, press **Options** and select *Preview*.

Saved items folder and My folders

To organise your messages, you can move some of them to the *Saved items* folder, or add new folders for your messages.

While reading a message, press **Options**. Select *Move*, scroll to the folder that you want to move the message to and press **Select**.

To add or delete a folder, press **Menu**, and select *Messages, Saved items, Text messages* and *My folders*.

- To add a folder if you have not saved any folder, press **Add**. Otherwise, press **Options** and select *Add folder*.
- To delete a folder, scroll to the folder that you want to delete, press **Options** and select *Delete folder*.

Flash messages

Flash messages are text messages that are displayed instantly.

Writing a flash message

Press **Menu**, and select *Messages, Create message* and *Flash message*. For further operation, see Writing and sending messages on page 50. The maximum length of a flash message is 70 characters. To insert a blinking text into the message, select *Insert blink char.* from the options list to set a marker. The text behind the marker blinks until a second marker is inserted.



Note: Only devices that offer compatible flash message features can receive and display blinking flash messages.

Receiving a flash message

A received flash message is not automatically saved. To read the message, press **Read**. Press **Options** and select *Use detail* to extract phone numbers, e-mail addresses and website addresses from the current message. To save the message, press **Save** and select the folder in which you want to save the message.

Multimedia messages (MMS)



Note: Only devices that offer compatible multimedia message features can receive and display multimedia messages.

A multimedia message can contain text, sound and a picture or a video clip. The phone supports multimedia messages that are up to 100 kB in size. If the maximum size is exceeded, the phone may not be able to receive the message. Depending on the network, you may receive a text message that includes an Internet address where you can view the multimedia message.

If the message contains a picture in compatible format, the phone may scale it down to fit the display area.

The multimedia message function uses shared memory, see Shared memory on page 16.

If *Allow multimedia reception* is set to *Yes* or *In home network*, your operator or service provider may charge you for every message you receive. The default setting to receive multimedia messages is generally on. See Settings for multimedia messages on page 75.

Multimedia messaging supports the following formats:

- Picture: JPEG, GIF, WBMP, BMP and PNG.
- Sound: Scalable Polyphonic MIDI (SP-MIDI), AMR audio and monophonic ringing tones.
- Video clips in 3gp format with SubQCIF and QCIF resolution and AMR audio.

The phone does not necessarily support all variations of the aforementioned file formats. If a received message contains any unsupported elements, they may be replaced with the file name and the text *Object format not supported*.

Note that you are not able to receive any multimedia messages if you have a call in progress, or a game or another Java application running. Because delivery of multimedia messages can fail for a variety of reasons, do not rely solely upon them for essential communications.

Writing and sending a multimedia message

To set the settings for multimedia messaging, see Settings for multimedia messages on page 75. To check availability and to subscribe to the multimedia messaging service, contact your network operator or service provider.

Copyright protections may prevent some images, ringing tones and other content from being copied, modified, transferred or forwarded.

1. Press **Menu**, and select *Messages, Create message* and *Multimedia msg.*
2. Key in a message. See Writing text on page 39.
 - To insert a file in the message, press **Options**, select *Insert* and select the desired option. You cannot select an option if it is dimmed. The list of available folders in the *Gallery* is shown. Open a specific folder, scroll to the desired file, press **Options** and select *Insert*. An attached file is indicated with the file name in the message. Please note that you cannot insert a theme in a new message.

To move the text component to the top or bottom of the message, press **Options** and select *Place text first* or *Place text last*.

- Your phone supports the sending and receiving of multimedia messages that contain several pages (slides). To insert a slide in the message, press **Options**, and select *Insert* and *Slide*. Each slide can contain text, one image and one sound clip.

If the message contains several slides, you can open the desired one by pressing **Options** and selecting *Previous slide*, *Next slide* or *Slide list*.

To change the time a slide will be displayed in a slide presentation select the slide, press **Options** and select *Slide timing*. To change the default value see *Default slide timing* in Settings for multimedia messages on page 75.

- To insert a name from the contacts list, press **Options** and select *More options*, *Insert contact* and the desired name.

To insert a number from the contacts list, press **Options** and select *More options* and *Insert number*.

- To insert a calendar note, press **Options** and select *Insert* and *Calendar note*.
- To insert a business card, press **Options** and select *Insert* and *Business card*.
- To delete an image, slide or sound clip from the message, press **Options** and select *Delete* and the desired function.
- To save the message in the *Saved items* folder, press **Options** and select *Save message*.
- To add a subject to the message, press **Options** and select *More options* and *Edit subject*.
- To view for example the size or recipient of the message, press **Options** and select *More options* and *Message details*.

3. To view the message or slide presentation before sending it, press **Options** and select *Preview*.
4. To send the message, press **Send**, or press **Options** and select *Send to e-mail* or *Send to many*.

5. Enter the recipient's phone number (or e-mail address) or search for it in *Contacts*. Press **OK** and the message is moved to the *Outbox* folder for sending.



It takes more time to send a multimedia message than to send a text message. While the multimedia message is being sent, the animated indicator  is displayed and you can use other functions on the phone. If there is an interruption while the message is being sent, the phone tries to resend it a few times. If this fails, the message will remain in the *Outbox* folder and you can try to resend it later.

The messages that you have sent will be saved in the *Sent items* folder if the setting *Save sent messages* is set to *Yes*. See Settings for multimedia messages on page 75. Multimedia messages are indicated with .

Reading and replying to a multimedia message



Important: Multimedia message objects may contain viruses or otherwise be harmful to your device or PC. Do not open any attachment if you are not sure of the trustworthiness of the sender.

When your phone is receiving a multimedia message, the animated indicator  is displayed. When the message has been received, the indicator  and the text *Multimedia message received* are shown.

The blinking  indicates that the memory for multimedia messages is full, see Multimedia messages memory full on page 60.

The appearance of a multimedia message may vary depending on the receiving device.

1. Press **Show** to view the message, or press **Exit** to view it later.

Reading the message later: Press **Menu**, and select *Messages* and *Inbox*. An unread multimedia message is indicated by .

2. Scroll to view the message. Press **Options** and, for example, some of the following options may be available.
- *Play presentation* to view the presentation attached in the message.
 - *View text* to view only the text in the message.
 - *Open image*, *Open sound clip* or *Open video clip* to open the corresponding file.
 - *Save image*, *Save sound clip* or *Save video clip* to save the corresponding file in the *Gallery*.
 - *Details* to view the details of the attached file.
 - *Delete message* to delete a saved message.
 - *Reply* or *Reply to all* to reply to the message. To send the reply, press **Options** and select *Send*.
 - *Forward to no.*, *Forward to e-mail* or *Forward to many* to forward the message.
 - *Edit* to edit a message. You can only edit messages you have created. See Writing and sending a multimedia message on page 56.
 - *Message details* to view the subject, size and the type of message.
 - Refer also to the options in *Gallery*, see *Gallery* on page 109.

Inbox, Outbox, Saved and Sent items folders

The phone saves the multimedia messages that have been received in the *Inbox* folder.

Multimedia messages that have not yet been sent are moved to the *Outbox* folder.

The multimedia messages that you wish to send later can be saved in the *Saved items* folder.

The multimedia messages that have been sent are saved in the *Sent items* folder of the *Multimedia msgs.* submenu if the setting *Save sent messages* is set to *Yes*. See Settings for multimedia messages on page 75.

Multimedia messages memory full

When you have a new multimedia message waiting and the memory for the messages is full, the indicator  blinks and *Multimedia memory full, view waiting msg.* is shown. To view the waiting message, press **Show**. To save the message, press **Options**, select *Save message* and delete old messages by first selecting the folder and then the old message to be deleted.

To discard the waiting message, press **Exit** and **Yes**. If you press **No**, you can view the message.

Instant messages (Chat)

Instant messaging (Chat) is a way of sending short, simple text messages that are delivered over TCP/IP protocols to online users (network service). Your contact list shows you when the contacts on the list are online and available to participate in an instant messages conversation. When you have written and sent your message, it stays on the display. The reply message appears below your original message.

Before you can use instant messaging, you need to subscribe to the service. For availability, charging and subscription to the service, contact your network operator or service provider, from whom you also receive your unique ID and password and the settings for instant messaging. For setting the required settings for the instant messaging service, see Instant messaging settings on page 68.

The icons and texts on the display may vary depending on the instant messaging service.

You can use the other functions of the phone while you have an active instant messaging session in the background. Depending on the network, the active instant messaging session may consume the phone's battery faster and you may need to connect the phone to a charger.

Instant messaging uses shared memory, see Shared memory on page 16.

Basic steps for the instant messaging

- To enter the instant messaging menu (offline), see Entering the instant messaging menu on page 62.
- To connect to the service (online), see Connecting to and disconnecting from the instant messaging service on page 62.
- To start a conversation with a contact, see *IM contacts* in Starting an instant messaging conversation on page 63.
To create your own contact lists, see Contacts for instant messaging on page 66.
- To join a public group, see *Groups* in Starting an instant messaging conversation on page 63.
To join an instant messaging group via an invitation message, see Accepting or rejecting an invitation on page 64.
To create your own group, or to join or delete a public group, see Groups on page 67.
- To edit your own information, see Editing your own settings on page 66.
- To search users and groups, see *Search* in Starting an instant messaging conversation on page 63.
- To read a message, see Reading an instant message on page 64.
- To write and send messages during an active session, see Participating in a conversation on page 65.
- To view, rename or delete saved conversations, select *Saved convers.* when you have entered the *Instant messages* menu.
- To block/unblock contacts, see Blocking and unblocking messages on page 67.
- To disconnect from the service, see Connecting to and disconnecting from the instant messaging service on page 62.

Entering the instant messaging menu

To enter the *Instant messages* menu while still offline, press **Menu**, and select *Messages* and *Instant messages*. Activate a service and then select

- *Login* to connect to the service.

To set the phone to automatically connect to the service when you enter the *Instant messages* menu, see Connecting to and disconnecting from the instant messaging service on page 62.

- *Saved convers.* to view, erase or rename the conversations that you have saved during a session. You can select *Saved convers.* also when you have connected to the service.
- *Connect.settings* to access the settings needed for a connection. See Instant messaging settings on page 68. You can select *Connect.settings* also when you have connected to the service.

Connecting to and disconnecting from the instant messaging service

To connect to the service, enter the *Instant messages* menu, activate a service and select *Login*. Select one of the available sets. If necessary key in the *User ID:* and the *Password:*. When the phone has successfully connected, *Logged in* is displayed.











Tip: To set the phone to automatically connect to the instant messaging service when you enter the *Instant messages* menu, connect to the service, select *My settings*, *Automatic login* and *On IM start-up*.

To disconnect from the service, select *Logout*.

Starting an instant messaging conversation

Enter the *Instant messages* menu and connect to a service. You can select

- *Conversations* to view the list of new and read messages or invitations to instant messaging during the active session. Scroll to the message or invitation that you want and press **Open** to read the message.
 -  indicates the new and  the read instant messages.
 -  indicates the new and  the read group messages.
 -  indicates the invitations.
- *IM contacts* includes the contacts that you have added. Scroll to the contact to whom you would like to send instant messages and press **Chat** or press **Open** if a new message is shown in the list. If you have received a new message from a contact, it is indicated with 
 -  indicates the online and  the offline contacts in the phone's contacts memory.
 -  indicates a blocked contact, refer to Blocking and unblocking messages on page 67.To add contacts to the list, see Contacts for instant messaging on page 66.
- *Groups* and *Public groups*. The list of bookmarks to public groups provided by the network operator or service provider is displayed. To start a conversation, scroll to a group and press **Join**. Enter the screen name that you want to use in the conversation. When you have successfully joined in the group conversation, the phone shows *Joined group*: and the group name. To create a private group, see Groups on page 67.
- *Search* and select *Users* or *Groups* to search for other users or public groups on the network.
 - If you select *Users*, you can search for a user by phone number, screen name, e-mail address or name.

- If you select **Groups**, you can search for a group by a member in the group or by group name, topic or ID.

To start the session when you have found the user or the group that you want, press **Options** and select **Chat** or **Join group**.

- To start a session from Contacts, see Viewing the subscribed names on page 88.

Accepting or rejecting an invitation

In standby mode, when you have connected to the service and you receive a new invitation, **New invitation received** is displayed. Press **Read** to read it.

If more than one invitation is received, the number of messages followed by **new invitations received** is displayed. Press **Read**, scroll to an invitation that you want and press **Open**.

- To join the private group conversation, press **Accept**. Enter the screen name that you want to use as a nickname. When you have successfully joined the group, the phone shows **Joined group:** and the group name.
- To reject or delete the invitation, press **Options** and select **Reject** or **Delete**.

Reading an instant message

In standby mode, when you have connected to the service and you receive a message from a person who is not taking part in the conversation, **New instant message** is displayed. Press **Read** to read it.

If more than one message is received, the number of messages followed by **new instant messages** is displayed. Press **Read**, scroll to a message and press **Open**.

New messages received during an active session are held in the **Conversations** of the **Instant messages** menu. If the message is from a person whose contact information is missing from the contact list in **IM contacts**, the sender's ID is shown. If the contact information can be found in the phone's memory for

contacts and the phone recognises it, the sender's name is shown. To save a new contact in the phone's memory, press **Options** and select

- **Save contact** and enter the name of the person.
- **Add to contact** and select the contact to which you want to add the detail and press **Add**.

Participating in a conversation

Join or start a session by pressing **Write**.





Tip: If you receive a new message during a conversation from a person that is not within the active conversation, the indicator (☰) is shown on the top of the display and a alarm tone is played.

Write your message and press **Send** or  to send it. If you press **Options**, some of the following options are available:

- **View conversation** to view the ongoing conversation. To save the conversation, press **Save** and enter a name for the conversation.
- **Save contact**, refer to Reading an instant message on page 64.
- **Add to contact**, refer to Reading an instant message on page 64.
- **Group members** to view the members of the selected private group. The option is only shown if you have created the group.
- **End conversation** to end the ongoing conversation.
- **Dictionary** refer to Writing text on page 39.

Editing your own settings

Enter the *Instant messages* menu and connect to the service. Select *My settings* to view and edit your own availability information or screen name. Select *Availability* and *Available for all* or *Avail. for contacts* (or *Appear offline*) to allow all the other users or only the contacts on your contact list to see that you are online when you have connected to the service. When you are connected to the service,  indicates that you are online and  that you are not visible to others.

Contacts for instant messaging

To add contacts to the instant messaging contacts list, connect to the service and select *IM contacts*.

If the contacts list is empty the phone displays *Contact list empty. Copy contacts from server?* to retrieve available contacts from the server.

Otherwise press **Options** and select *Add contact*, or if you have no contacts added, press **Add**. Select

- *Enter ID manually* to enter the ID manually.
- *Search from serv.* to search for a contact from the server.
- *From contacts* to search for a name in *Contacts*.
- *Copy from server* to copy a name from a server-based contacts list.

When the contact is added, the phone displays *Added to IM contacts:* and the contact name.

Scroll to a contact, and press **Chat** to start a session or press **Options** and select

- *Contact info* to view the details of the selected contact. If you want to edit the details, see Editing or deleting details in the *Contacts* menu (menu 3) on page 85.
- *Edit name* to edit the contact's name.
- *Block contact* (or *Unblock contact*) to block (or unblock) the messages from the selected contact.

- *Add contact* to add a new contact from the phone's contact memory.
- *Remove contact* to remove a contact from the contact list.
- *Copy to server* to copy a name to a server-based contacts list.
- *Availability alerts* to mark those contacts from whom you wish to receive availability alerts.

Blocking and unblocking messages

Connect to the service and select *Conversations* or *IM contacts*. Highlight the contact in the contacts list from whom you want to block incoming messages. Press **Options**, select *Block contact* and press **OK**.

To unblock the messages, connect to the service and select *Blocked list*. Scroll to the contact from whom you want to unblock the messages and press **Unblock**.

You can also unblock the messages from the contact list, see Contacts for instant messaging on page 66.

Groups

You can create your own private groups for a session, or use the public groups provided by the service provider. The private groups exist only during an active session. You can add to a private group only the contacts that are in your contact list and thus in the phone's contacts memory, see Saving names and phone numbers (Add contact) on page 82. If the server you are logged onto does not support group services all groups related menus are dimmed.

Public groups

You can bookmark public groups that your service provider may maintain. Connect to the service, select *Groups* and *Public groups*. Scroll to a group that you want to chat with and press **Join**. If you are

not in the group, key in your screen name as your nickname for the group. If you press **Options**, you can select *Delete group* to delete a group from your group list.

Creating a private group

Connect to the service, select *Groups* and *Create group*. Key in the name for the group and the screen name that you want to use for the group. You can use another screen name in another group. Mark your private group members from the contacts list and key in an invitation to newly added members.

Instant messaging settings

You may receive the settings as a configuration message from the network operator or service provider. To receive the settings as a configuration message, see Configuration settings service on page 18. To key in the settings manually, see Configuration settings on page 106. For the instant messaging and presence settings, contact your network operator or service provider.

To enter the *Instant messages* menu while still offline, press **Menu**, and select *Messages* and *Instant messages*. Activate a service and select *Connect.settings*. Select

- *Configuration* and scroll to the set you would like to activate and press **Select**.
- *Account* to see the accounts provided by the service provider. If more than one account is displayed choose the one you want to use.
- *User ID* to view or to edit the user ID.
- *Password* to enter the password.

E-mail application

The e-mail application allows you to access the compatible e-mail account that you use in the office or at home, via the phone (network service). You can write, send, and read e-mails with your phone. Your phone supports POP3 and IMAP4 e-mail servers.

The e-mail application uses shared memory, see Shared memory on page 16.

Before you can send and retrieve any e-mails, you may need to do the following:

- Obtain a new e-mail account or use the current one. To check the availability of your e-mail account contact your e-mail service provider.
- To check the settings required for the e-mail application, contact your network operator or e-mail service provider. To receive the e-mail settings as a configuration message, see Configuration settings service on page 18.
- To set the e-mail settings on your phone, press **Menu** and select *Messages*, *Message settings* and *E-mail messages*. See Settings for e-mail application on page 76.

Writing and sending an e-mail

You can write your e-mail before connecting to the e-mail service, or connect to the service first, and then write and send your e-mail.

1. Press **Menu** and select *Messages*, *E-mail*, and *Create e-mail*. The waiting note is displayed.
2. Key in the recipient's e-mail address and press **OK** or press **Edit** and key in the e-mail address, and press **OK**.

To search for the e-mail address in *Contacts*, press **Options**, and select *Search*.

3. You can key in a subject for the e-mail if you want, and press **OK**.

If you press **Options**, you can select one of the following: the message editor, add a new recipient, add a copy recipient or add a hidden copy recipient.

4. Key in the e-mail message, see Writing text on page 39. The number of characters that you can key in is shown on the top right of the display.
5. To send the e-mail, press **Send**. Select
 - **Send now** to initiate sending instantly. If you have not already connected to the e-mail account, your phone establishes the connection first and then sends the e-mail.
 - **Send later** to send your e-mail later. The e-mail is saved in the **Outbox** folder. If you want to edit or continue writing your e-mail later, you can save it in **Drafts** by selecting **Save draft msg.**
Sending the e-mail later: Press **Menu** and select **Messages** and **E-mail**, press **Options** and select **Send now** or **Retrieve and send**.

After sending the e-mail, the phone asks if you want to disconnect from the e-mail service. Press **Yes** to disconnect or **No** to leave the connection open.



Note: When sending e-mails, your phone may display the words **Message sent**. This is an indication that the e-mail has been sent by your phone to the e-mail server. This is not an indication that the e-mail has been received at the intended destination. For more details about e-mail services, check with your service provider.

Downloading e-mails from your e-mail account

1. Press **Menu** and select **Messages**, **E-mail** and **Retrieve** to download e-mails that have been sent to your e-mail account. Or:

Press **Menu** and select **Messages** and **E-mail**, press **Options** and select **Retrieve and send** to download new e-mails and to send e-mails that have been saved in the **Outbox** folder.

If the message memory is full, delete some of your older messages before you start to download new messages.

2. Your phone makes a connection to the e-mail service. A status bar is shown while your phone is downloading e-mails to your phone.
After the download, the phone asks if you want to disconnect from the e-mail service. Press **Yes** to disconnect or **No** to leave the connection open.
3. Press **Select** to view the new message in the *Inbox*, or press **Back** to view it later.
If more than one message is received, select the message that you want to read. An unread text message is indicated by .

Reading and replying to an e-mail



Important: E-mails may contain viruses or otherwise be harmful to your device or PC. Do not open any attachment if you are not sure of the trustworthiness of the sender.

1. Press **Menu**, select *Messages*, *E-mail* and *Inbox*.
2. While reading the message, press **Options**.
You can, for example, view the details of the selected message, mark the message as unread, delete it, reply to it, reply to all, forward it or move the message to another folder.
If the message does not fit in the first page, press *Next pg.* to view the next page of the message.
3. To reply to an e-mail, press **Reply**. Select *Original text* to include the original message in the reply or select *Empty screen*.
When replying to an e-mail, first confirm or edit the e-mail address and subject, then write your reply.
4. To send the message, press **Send** and select *Send now*.
To send the message later, press *Send later*. The message is moved to the *Outbox* folder.
After sending the message, the phone asks if you want to disconnect from the e-mail service. Press **Yes** to disconnect or **No** to leave the connection open.

Inbox and Other folders (Drafts, Archive, Outbox and Sent items)

Your phone has the following folders in the *E-mail* menu:

- *Inbox* for saving e-mails that you have downloaded from your e-mail account.
- *Other folders* contains the folders: *Drafts* for saving unfinished e-mails, *Archive* for organising and saving your e-mails, *Outbox* for saving e-mails that have not been sent, if you have selected *Send later*, see Writing and sending an e-mail on page 69, and *Sent items* for saving e-mails that have been sent.

Deleting e-mails

To delete e-mails, press **Menu** and select *Messages* and *E-mail*, press **Options** and select *Delete messages*.

To delete all messages from a folder, select the folder from which you want to delete the messages and press **Yes**. To delete all messages from all folders, select *All messages* and press **Yes**.

Note that deleting an e-mail from your phone does not delete it from the e-mail server.

Voice messages

The voice mailbox is a network service and you may need to subscribe to it. For more information and for the voice mailbox number, contact your service provider.

Press **Menu**, and select *Messages* and *Voice messages*. Select

- *Listen to voice messages* to call your voice mailbox at the phone number that you have saved in the *Voice mailbox number* menu.

If you have two phone lines available (network service), each phone line may have its own voice mailbox number. Refer to Call settings on page 100.

- *Voice mailbox number* to key in, search for or edit your voice mailbox number and press **OK** to save it.

If supported by the network, the indicator  will show new voice messages. Press **Listen** to call your voice mailbox number.



Tip: Pressing and holding **1**  calls your voice mailbox if you have the number set.

Info messages

With the info message network service you may be able to receive messages on various topics from your service provider. These messages may include, for example, weather or traffic conditions. For availability, topics and the relevant topic numbers, contact your service provider.

Service commands

Press **Menu**, and select *Messages* and *Service commands*. Key in and send service requests (also known as USSD commands), such as activation commands for network services, to your service provider.

Deleting all messages from a folder

To delete all messages from a folder, press **Menu**, and select *Messages* and *Delete messages*.

To delete all messages from a folder, select the folder from which you want to delete the messages and press **OK** to confirm the query.

If the folder contains unread messages, the phone will ask whether you want to delete them also.

Message settings

The message settings affect the sending, receiving and viewing of messages.

Settings for text and SMS e-mail messages

Press **Menu**, and select *Messages*, *Message settings* and *Text messages*.

Sending profile

Select *Sending profile*. If more than one message profile set is supported by your SIM card, select the set that you want to change.

- Select *Message centre number* to save the phone number of the message centre that is required for sending text messages. You will receive this number from your service provider.
- Select *Messages sent via* to select the message type *Text*, *E-mail*, *Paging* or *Fax*.
- Select *Message validity* to select the length of time for which the network should attempt to deliver your message.
- For the message type *Text*, select *Default recipient number* to save a default number for sending messages for this profile.

For the message type *E-mail*, select *E-mail server* to save the e-mail server number.

- Select *Delivery reports* to ask the network to send delivery reports about your messages (network service).
- Select *Use GPRS* and select *Yes* to set GPRS as the preferred SMS bearer. Also, set *GPRS connection* to *Always online*, see (E)GPRS connection on page 104.
- Select *Reply via same centre* to allow the recipient of your message to send you a reply via your message centre (network service).

- Select *Rename sending profile* to change the name of the selected message profile. The default profile cannot be renamed. The message profile sets are only displayed if your SIM card supports more than one set.

Save message setting

Press **Menu**, and select *Messages*, *Message settings*, *Text messages* and *Save sent messages*. Select *Yes* to set the phone to save sent multimedia messages in the *Sent items* folder. If you select *No*, the sent messages are not saved.

Settings for multimedia messages

If *Allow multimedia reception* is set to *Yes* or *In home network*, your operator or service provider may charge you for every message you receive. The default setting to receive multimedia messages is generally on.

Press **Menu**, and select *Messages*, *Message settings* and *Multimedia msgs.*. Select

- *Save sent messages*. Select *Yes* to set the phone to save sent multimedia messages in the *Sent items* folder. If you select *No*, the sent messages are not saved.
- *Delivery reports* to ask the network to send delivery reports about your messages (network service).
- *Scale image down* to define the image size when you insert the image into the multimedia message.
- *Default slide timing* to define the default time for slides in multimedia messages.
- *Allow multimedia reception*. Choose *No*, *Yes* or *In home network* to use the multimedia service. If you choose *In home network*, you cannot receive multimedia messages when outside your home network.

If *Allow multimedia reception* is set to *Yes* or *In home network*, your operator or service provider may charge you for every message you receive. The default setting to receive multimedia messages is generally on.

- *Incoming multimedia messages*. Select *Retrieve* to set the phone to automatically fetch newly received multimedia messages, or select *Reject* if you do not wish to receive multimedia messages. This setting is not shown if *Allow multimedia reception* is set to *No*.
- *Configuration settings*. Select *Configuration* and select the default service provider for retrieving multimedia messages. Select *Account* to see the accounts provided by the service provider. If more than one account is displayed choose the one that you want to use. You may receive the settings as a configuration message from the network operator or service provider. To receive the settings as configuration message, see Configuration settings service on page 18. To key in the settings manually see Configuration settings on page 106.
- *Allow adverts* to choose if you allow the reception of messages defined as advertisements. This setting is not shown if *Allow multimedia reception* is set to *No*.

Settings for e-mail application

You may receive the e-mail settings as a configuration message from the network operator or service provider. For receiving the settings as a configuration message, see Configuration settings service on page 18. To key in the settings manually see Configuration settings on page 106.

Select each of the settings individually and key in all the required settings. Contact your network operator or e-mail service provider for the settings.

Press **Menu** and select *Messages*, *Message settings*, and *E-mail messages*. Select

- *Configuration* and scroll to the set that you would like to activate and press **Select**.

- *Account* to see the accounts provided by the service provider. If more than one account is displayed choose the one that you want to use.
- *My name*. Key in your name or nickname.
- *E-mail address*. Key in e-mail address.
- *Include signature*. You can define a signature that is automatically added to the end of your e-mail, when you write your message.
- *Reply-to address*. Key in the e-mail address to which you want the replies to be sent.
- *SMTP user name*. Key in the name that you want to use for outgoing mails.
- *SMTP password*. Key in the password that you want to use for outgoing mails.
- *Display terminal window*. Select *Yes* to perform manual user authentication for intranet connections.
- *Incoming server type*. Select either *POP3* or *IMAP4* depending on the type of e-mail system that you are using. If both types are supported, select *IMAP4*.
- *Incoming mail settings*

If you have selected *POP3* as the incoming server type, the following options are shown:

- *Retrieve e-mails*. Key in the maximum number of e-mails that you want to retrieve at a time.
- *POP3 user name*. Key in the user name.
- *POP3 password*. Key in the password.
- *Display terminal window*. Select *Yes* to perform manual user authentication for intranet connections.

If you have selected *IMAP4* as the incoming server type, the following options are shown:

- *Retrieve e-mails*. Key in the maximum number of e-mails that you want to retrieve at a time.
- *Retrieval method*. Select *Latest* if you want to retrieve all newly received e-mails or select *Latest unread* if you want to retrieve only e-mails that you have not read.
- *IMAP4 user name*. Key in the user name.
- *IMAP4 password*. Key in the password.
- *Display terminal window*. Select *Yes* to perform manual user authentication for intranet connections.

Common settings

Press **Menu** and select *Messages*, *Message settings*, *Other settings* and *Font size* to select the font size for reading and writing messages.

Message counter

To view how many messages you have sent and received, press **Menu** and select *Messages* and *Message counter*. Select *Sent messages* or *Received messages* or select *Clear counters* to clear the counters.

■ Call register

The phone registers the phone numbers of missed, received and dialled calls, and the approximate length of your calls.



The phone registers missed and received calls only if the network supports these functions, and the phone is switched on and within the network's service area.

When you press **Options** in the *Missed calls*, *Received calls* and *Dialled numbers* menus, you can, for example, view the date and the time of the call, edit or delete the phone number from the list, save the number in *Contacts*, or send a message to the number.

Recent calls lists

Press **Menu**, and select *Call register* and then select

- *Missed calls* to view the list of up to 20 phone numbers from which somebody has tried to call you (network service). The number in front of the (name or) phone number indicates the amount of call attempts from that caller.



Tip: When a note about missed calls is displayed, press **List** to access the list of phone numbers. Scroll to the number that you would like to call back and press **Enter**.

- *Received calls* to view the list of up to 20 phone numbers from which you have most recently accepted calls (network service).
- *Dialled numbers* to view the list of up to 20 phone numbers that you have most recently called or attempted to call.



Tip: In standby mode, press **Enter** once to access the list of dialled numbers. Scroll to the number or name that you want, and press **Enter** to call the number.

- *Delete recent call lists* to delete the recent calls lists. Select whether you want to delete all the phone numbers in the recent calls lists, or only those numbers in the missed calls, received calls or dialled numbers lists. You cannot undo this operation.

Counters and timers for calls, data and messages



Note: The actual invoice for calls and services from your service provider may vary, depending upon network features, rounding off for billing, taxes and so forth.

Press **Menu**, and select *Call register* and then select

- *Call duration*. Scroll to view the approximate duration of your incoming and outgoing calls in hours, minutes and seconds. The security code is required to clear the timers.

If you have two phone lines available (network service), each phone line has its own call duration timers. The timers of the currently selected line are displayed. Refer to Call settings on page 100.

- *GPRS data counter*. Scroll to check the amounts of data that were sent or received in the last session, data sent and received in total, and to clear the counters. The counter unit is a byte. The security code is required to clear the counters.
- *GPRS connection timer*. Scroll to check the approximate duration of the last GPRS connection or the total GPRS connection time. You can also clear the timers. The security code is required to clear the timers.

■ Contacts



You can save names and phone numbers (Contacts) in the phone's memory and in the SIM card's memory.

- The phone's memory may save up to 1000 names with numbers and text notes about each name. You can also save an image for a certain number of names. The number of names that can be saved depends on the length of the names, and the number and length of the phone numbers and text items.
Contacts use shared memory, see Shared memory on page 16.
- The phone supports SIM cards that can save up to 254 names and phone numbers. Names and numbers saved in the SIM card's memory, are indicated by .

In dynamic contacts you can publish your current availability status to communicate to anyone who has access to this service and who is requesting this information. You can view the availability status of any of the contacts that you have subscribed to in the *Subscribed names* menu and in the detailed view of a name in *Contacts*. See My presence on page 85.

Selecting settings for contacts

Press *Menu* and select *Contacts* and *Settings*. Select

- *Memory in use* to select the memory, either SIM card or phone, that you want to use for your contacts. To recall names and numbers from both memories for contacts, select *Phone and SIM*. In that case, the names and numbers will be saved in the phone's memory.
- *Contacts view* to select how the names, numbers and images in contacts are displayed.
- *Memory status* to view how much memory is available in the selected memory for contacts.

Saving names and phone numbers (Add contact)

Names and numbers will be saved in the used memory, see Selecting settings for contacts above.

1. Press **Menu** and select *Contacts* and *Add new contact*.
2. Key in the name and press **OK**. See Using traditional text input on page 40.
3. Key in the phone number, and press **OK**. To key in the numbers, see Making a call on page 35.
4. When the name and number are saved, press **Done**.



Tip: Quick save In standby mode, key in the phone number and press **Save**. Key in the name, press **OK** and **Done**.

Saving multiple numbers or text items per name

You can save different types of phone numbers and short text items per name in the phone's internal memory for contacts.

The first number saved is automatically set as the default number and it is indicated with a frame around the number type indicator, for example . When you select a name from contacts, for example to make a call, the default number is used unless you select another number.

1. Make sure that the memory in use is either *Phone* or *Phone and SIM*. See Selecting settings for contacts on page 81.
2. To access the list of names and phone numbers, press  in standby mode.
3. Scroll to the name saved in the phone's internal memory for the contact to which you want to add a new number or text item, and press **Details**.
4. Press **Options** and select *Add number* or *Add detail*.
5. To add a number or detail, select one of the number types or text types, respectively.

- If you select the text type *User ID*:

Select *Search* to search for an ID by a mobile phone number or an e-mail address in the server of the operator or service provider if you have connected to the presence service. See My presence on page 85. If only one ID is found, it is automatically saved. Otherwise, to save the ID, press *Options*, and select *Save*.

To key in the ID, select *Enter ID manually*. Key in the ID and press *OK* to save it.

To change the number or text type, select *Change type* in the options list. Note that you cannot change the type of an ID when it is on the *IM contacts* or in the *Subscribed names* list.

To set the selected number as the default number, select *Set as default*.

6. Key in the number or text item and press *OK* to save it.
7. Press *Back* and then *Exit* to return to standby mode.

Adding an image to a name or number in contacts





You can add an image in supported format to a name or number saved in the phone's internal memory.

Press  in standby mode, scroll to the contact that you want to add an image to and press *Details*.

Press *Options* and select *Add image*. The phone opens the list of folders in the *Gallery*. Scroll to the desired image, press *Options* and select *Save to contacts*. A copy of the image is added to the contact.

Searching for a contact



1. Press *Menu* and select *Contacts* and *Search*, or to quickly find a contact name, press  in standby mode.
2. You can key in the first characters of the name you are searching for in the pop-up window.



Press  and  to scroll through the names in the list, and  and  to move the cursor in the pop-up window.

3. Scroll to the contact name that you want, and press **Details**. Press **View** to see the whole information.

Depending on the *Contacts view* selection in Selecting settings for contacts on page 81, the subscribed names are shown differently. Only the availability indicator or the availability indicator, the personal logo and the status message are shown. Press **Details** and all of the dynamic information is shown.



Tip: Viewing a contact. To quickly view a specific name with the default phone number, press and hold   at the name while scrolling through the contact names.

To view the status message in full, press **Details** and press and hold   at the dynamic contact while scrolling through the contact names.

Deleting contacts

Press **Menu** and select *Contacts* and *Delete* to delete contacts and all the details attached to them.

- To delete contacts individually, select *One by one* and scroll to the name that you want to delete. Press **Delete** and press **Yes** to confirm.

If the contact has an ID in *IM contacts* or in the *Subscribed names* list, the note *Presence information will be deleted* is shown before the contact is deleted.

- To delete contacts all at once, select *Delete all* and then scroll to either of the *Phone* or *SIM card* memories and press **Delete**. Press **Yes** and confirm with the security code.

Editing or deleting details

Search for the contact that you want to edit or delete and press **Details**. Scroll to the name, number, text item or image that you want to edit or delete and press **Options**.

- To edit a name, number or text item or to change image, select *Edit name*, *Edit number*, *Edit detail* or *Change image*, respectively.

Note that you cannot edit or delete an ID when it is in *IM contacts* or in the *Subscribed names* list.

- To delete a number or text item, select *Delete number* or *Delete detail*, respectively.
- To delete an image attached to the contact, select *Delete image*. Deleting an image from contacts does not delete it from *Gallery*.



My presence

With the presence service (network service) you can share your presence status with other users, for example your family, friends and colleagues with compatible devices and access to the service.

Presence status includes your availability, status message and personal logo. Other users who have access to the service and who are requesting your information are able to see your status. The requested information is shown in *Subscribed names* in the viewers *Contacts* menu. You can personalise the information that you want to share with others and control who can see your status.

Before you can use presence, you need to subscribe to the service. To check the availability, for charging details and to subscribe to the service, contact your network operator or service provider, from whom you also receive your unique ID and password and the settings for the service. To set the required settings for the presence service, see Instant messaging settings on page 68. While you have connected to the presence service, you can use the other functions of the phone, and the presence service is active in the background.

Press **Menu** and select *Contacts* and *My presence*. Select

- *Connect to 'My presence' service* (or *Disconnect*) to connect to (or to disconnect from) the service.
- *My current presence* to change your presence status. Select
 - *View current presence* and select *Private pres.* or *Public pres.* to view your current private or public status.
 - *My availability* to set your availability status to *Available* indicated by , or to *Busy* indicated by , or to *Not available* indicated by .
 - *My presence message* and key in the text to be shown to other persons or press **Options** and select *Previous msgs.* and select an old message as the status message.
 - *My presence logo* to select your personal logo from the *Graphics* folder in the gallery. If you select the *Default*, the logo is not published.
 - *Show to* to select the groups to whom you want to show your presence status or if not to show it at all.

Select *Private and public* and contacts in your private list are able to see all your presence information: availability, status message and logo. Other contacts can see only your availability.

Select *Private viewers* and the contacts in your private list can see all your presence information (availability, status message and logo). Other users will not see any information.

If you select *No one*, no one can see your presence information.

- *Viewers* and select
 - *Current viewers* to view all the persons who have subscribed to your presence information.

- *Private list* is a list of the persons who are allowed to view all your presence information, including availability, status message and logo. You can manage your own private list. Other persons who are not in the private list, can see only your availability.
- *Blocked list* to view all the persons you have blocked from viewing your presence information.
- *Settings* and select
 - *Show current presence in idle* to show the current status indicator in standby mode.
 - *Synchronise with profiles* to select whether you want to update your *My presence message* and *My availability* manually or automatically by linking them to the currently active profile. Refer also to Profiles on page 94. Note that you cannot link a personalised status logo to a Profile.
 - *Connection type* to select if the phone connects automatically to the service when the phone is switched on.
 - *IM and my presence settings*, see Instant messaging settings on page 68.

Subscribed names

You can create a list of contacts whose presence status information you want to be aware of. You can view the information if the contacts allow you to view it and if it is not prevented by the contact or network. You can view these subscribed names either by scrolling through the contacts or via the *Subscribed names* menu.

Ensure that the memory in use is either *Phone* or *Phone and SIM*. See Selecting settings for contacts on page 81.

To connect to the Presence service, press **Menu** and select *Contacts*, *My presence* and *Connect to 'My presence' service*. You can view the subscribed names even when you are not connected to the presence service but you cannot see the presence status information about the contact.

Adding contacts to the subscribed names

1. Press **Menu** and select *Contacts* and *Subscribed names*. If you have not connected to the Presence service, the phone asks if you want to connect now.
2. If you have no contacts on your list, press **Add**. Otherwise, press **Options** and select *Subscribe new*. The list of your contacts is shown.
3. Select a contact from the list and if the contact has a user ID saved, the contact is added to the subscribed names list. If there is more than one ID, select one of them. After subscription of the contact, *Subscription activated* is shown.



Tip: To subscribe to a contact from *Contacts* list, press  in standby mode and scroll to the contact you want to subscribe to. Press **Details** and press **Options**. To subscribe, select *Request presence* and select *As subscription*.



If you only want to view the presence information but not to subscribe to a contact, select *Request presence* and *One time only*.

Viewing the subscribed names

Refer also to Searching for a contact on page 83 to view the presence information.

1. Press **Menu** and select *Contacts* and *Subscribed names*.

The status information of the first contact on the subscribed names list is displayed. The information that the person wants to give to others may include text and some of the following icons:

 ,  or  indicate that the person is either available, discreet or not available.

 indicates that the person's presence information is not available.

2. Press **Details** to view the details of the selected contact, or press **Options** and select

- *Subscribe new* to add a new contact to the list of subscribed names.
- *Chat* to start a conversation.
- *Send message* to send a text message to the selected contact.
- *Send SMS e-mail* to send an e-mail to the selected contact.
- *Send bus. card* to send a business card to the selected contact.
- *Unsubscribe* to remove the selected contact from the list of subscribed names.

Unsubscribing a contact

- To unsubscribe a contact from the *Contacts* list, press ▼ in standby mode and scroll to the contact that you want to unsubscribe. Press *Details* and *Details* again, select the ID and press *Options*. To unsubscribe, select *Unsubscribe* and press *Yes* to confirm.
- To unsubscribe via the *Subscribed names* menu, see Viewing the subscribed names on page 88.

Copying contacts

You can copy names and phone numbers from the phone's memory to your SIM card's memory and vice versa. Note that any text items saved in the phone's internal memory, such as e-mail addresses, will not be copied to the SIM card.

1. Press *Menu* and select *Contacts* and *Copy*.
2. Select the copying direction, *From phone to SIM card* or *From SIM card to phone*.
3. Select *One by one*, *All* or *Default numbers*.
 - If you select *One by one*, scroll to the name that you want to copy and press *Copy*.

Default numbers is shown if you copy from the phone to the SIM card. Only the default numbers will be copied.

- To choose whether you want to keep or delete the original names and numbers, select *Keep original* or *Move original*.
 - If you select *All* or *Default numbers*, press *Yes* when *Copy contacts?* or *Move contacts?* is displayed.

Sending and receiving a business card

You can send and receive a person's contact information from a compatible device as a business card.

When you have received a business card, press **Show** and **Save** to save the business card in the phone's memory. To discard the business card, press **Exit** and then **Yes**.

To send a business card, search for the name and phone number that you want to send from *Contacts*, press **Details** and **Options** and select *Send bus. card*. Select *Via text message* (network service) or *Via multimedia* (network service) and *Default number* or *All details*.

No pictures can be sent if you choose *Via text message*.

Speed dials

To assign a number to a speed-dialling key, press **Menu** and select *Contacts* and *Speed dials* and scroll to the speed-dialling key number that you want.

Press **Assign**, or if a number has already been assigned to the key, press **Options** and select *Change*. Press **Search**, and select first the name and then the number that you want to assign. If the *Speed dialling* function is off, the phone asks whether you want to activate it. See also *Speed dialling* in Call settings on page 100.

To make a call using the speed-dialling keys, see Speed dialling a phone number on page 36.

Voice dialling

You can make a phone call by saying a voice tag that has been added to a phone number. Any spoken word(s), such as a person's name(s), can be a voice tag. You can add up to ten voice tags.

Before using voice tags, note that:

- Voice tags are not language-dependent. They are dependent on the speaker's voice.
- You must say the name exactly as you said it when you recorded it.
- Voice tags are sensitive to background noise. Record voice tags and use them in a quiet environment.
- Very short names are not accepted. Use long names and avoid similar names for different numbers.





Note: Using voice tags may be difficult in a noisy environment or during an emergency, so you should not rely solely upon voice dialling in all circumstances.

Adding and managing voice tags

Save or copy in the phone's memory the contacts to which you want to add a voice tag. You can also add voice tags to the names in the SIM card, but if you replace your SIM card with a new one, you first need to delete the old voice tags before you can add new ones.

Voice tags use shared memory, see Shared memory on page 16.

1. In standby mode, press .
2. Scroll to the contact to which you want to add a voice tag and press **Details**. Scroll to the phone number you want and press **Options**.
3. Select **Add voice tag**.
4. Press **Start**, and say clearly the word(s) you want to record as a voice tag. After recording, the phone plays the recorded tag.

When the voice tag has been successfully saved, *Voice tag saved* is displayed, a beep sounds and a symbol  appears after the phone number with a voice tag.

To check the voice tags, press **Menu** and select *Contacts* and *Voice tags*. Scroll to the contact with the voice tag that you want, and press **Select** to see the options to listen to, delete or change the recorded voice tag.

Making a call by using a voice tag

If the phone has an application using the GPRS connection sending or receiving data, first end the application to make a call by using voice dialling.

1. In standby mode, press and hold the right selection key. A short tone is heard and *Speak now* is displayed.
2. Say the voice tag clearly. The phone plays the recognised voice tag and then dials the phone number of the voice tag after 1.5 seconds.

If you are using a compatible headset with the headset key, press and hold the headset key to start the voice dialling.

Info numbers and service numbers

Your service provider may have included information numbers or service numbers in your SIM card. These menus are only shown if supported by your SIM card.

Press **Menu** and select *Contacts* and *Info numbers* or *Service numbers*. Scroll through a category to an information number, or to a service number, and press  to call the number.

My numbers

The phone numbers assigned to your SIM card are saved in *My numbers* if this is allowed by the card. To view the numbers, press **Menu** and select *Contacts* and *My numbers*. Scroll to the desired name or number, and press **View**.

Caller groups

You can arrange the names and phone numbers saved in *Contacts* into caller groups. For each caller group, you can set the phone to sound a specific ringing tone and show a selected graphic on the display when the phone recognises a call from a phone number in the group, see below. To set the phone to ring only upon calls from phone numbers belonging to a selected caller group, see *Alert for* in Tone settings on page 95.

Press **Menu** and select *Contacts* and *Caller groups* and select the desired caller group. Select

- *Group name*, key in a new name for the caller group and press **OK**.
- *Group ringing tone* and select the ringing tone for the group. *Default* is the ringing tone selected for the currently active profile.
- *Group logo* and select *On* to set the phone to display the group logo, *Off* not to display it, or *View* to view the logo.
- *Group members* to add a name to the caller group, press **Add**. Scroll to the name you want to add to the group and press **Add**.

To remove a name from a caller group, scroll to the name that you want to remove, and press **Options** and select *Remove contact*.



■ Settings

Profiles

Your phone has various setting groups, profiles, for which you can customise the phone tones for different events and environments. Initially, personalise the profiles to your own liking and then you only need to activate a profile to use it. Available profiles are *General*, *Silent*, *Meeting*, *Outdoor*, *My style 1*, and *My style 2*.

Press **Menu**, and select *Settings* and *Profiles*. Scroll to a profile and press **Select**.

- To activate the selected profile, select *Activate*.
- To personalise the profile, select *Personalise*. Select the setting you want to change and make the changes.

For the tone settings, see Tone settings on page 95.

Select *Light sequences* to set the light sequences on or off.

To rename a profile, select *Profile name*. The *General* profile cannot be renamed.

To change your presence status information, select *My presence*. This menu is available if you have set *Synchronise with profiles* to *On*, see My presence on page 85. Select *My availability* to change your availability status and *My presence message* to edit your status message.

- To set the profile to be active until a certain time up to 24 hours, select *Timed* and set the time for the profile setting to end. When the time set for the profile expires, the previous profile that was not timed, becomes active.



Tip: To change the profile quickly in standby mode, press the power key , scroll to the profile that you want to activate and press **Select**.

Themes

A theme is a package that may include a screen saver, a wallpaper image, a ringing tone and a colour scheme to customise your phone for different events and environments. Themes are stored in *Gallery*.

Press *Menu*, and select *Settings* and *Themes*.

- To activate a theme, select *Select theme* to view the *Themes* folder in *Gallery*. Open the folder and scroll to a theme. Press *Options* and select *Apply theme*. Refer also to *Gallery* on page 109.
- To download new themes, select *Theme downloads*. Refer to *Downloading* on page 136.

Tone settings

Press *Menu*, and select *Settings* and then *Tone settings*. You can find the same settings in the *Profiles* menu, see *Profiles* on page 94. Note that the settings you make will change the settings in the active profile.

Select *Incoming call alert* to choose how the phone notifies you of an incoming voice call. The options are *Ringing*, *Ascending*, *Ring once*, *Beep once* and *Off*.

Select *Ringing tone* for incoming voice calls. To select ringing tones from *Gallery*, select *Open gallery* from the ringing tone list.



Tip: If you receive a ringing tone by downloading, you can save it in the *Gallery*.

Select *Ringing volume* and *Vibrating alert* for incoming voice calls and messages. The vibrating alert does not work when the phone is connected to a charger, a desktop stand, a car kit, or other like enhancement.

Select *Message alert tone* to set the alert tone for the incoming messages or *Instant message alert tone* to set the alert tone for instant messages. Select *Keypad tones*, or *Warning tones* to set the phone to sound tones, for example, when the battery is running out of power.

Select *Alert for* to set the phone to ring only upon calls from phone numbers that belong to a selected caller group. Scroll to the caller group you want to select or choose *All calls* and press *Mark*.

Light settings

Lets you select if different light sequences follow the phone functions.

Press *Menu*, and select *Settings*, *Light settings* and *Light sequences* to set the light sequences on or off.

Personal shortcuts

With personal shortcuts you get quick access to frequently used phone functions.

Right selection key

You can allocate one phone function from a predefined list to the right selection key. Refer also to Standby mode on page 30. This menu is not shown in some operator variants.

Press *Menu*, and select *Settings*, *Personal shortcuts* and *Right selection key*. Select a function from the list. The name of the right selection key changes in standby mode according to the function.

Go to options

You can allocate phone functions from a predefined list to the left selection key.

Press *Menu*, and select *Settings* and *Personal shortcuts*. Select *Select 'Go to' options* to choose the functions that you want to appear in the shortcut list. Select *Organise 'Go to' options* to rearrange the functions on your personal shortcut list. Refer also to Standby mode on page 30.

Voice commands

You can have phone functions which can be activated by saying a voice tag. Up to five functions can be selected for voice tag.

Press **Menu**, and select *Settings*, *Personal shortcuts* and *Voice commands*. Select the function folder that you want and scroll to the function to which you want to add a voice tag and press **Add**. A voice tag is indicated with . Refer to the instructions in section Adding and managing voice tags on page 91.

To activate a voice command, refer to the instructions in section Making a call by using a voice tag on page 92.

During a call or when an application using the (E)GPRS connection is sending or receiving data, you cannot activate or add a voice command.

Display settings

Press **Menu**, and select *Settings* and *Display settings*.

- Select *Wallpaper* to set your phone to display a background image, known as wallpaper, when the phone is in standby mode. Some images are preserved in the *Gallery* menu. You can also receive images, for example, via multimedia messages, or transfer them with PC Suite from your PC and then save them in *Gallery*. Your phone supports JPEG, GIF, WBMP, BMP and PNG formats but not necessarily all variations of these file formats.

To select the wallpaper, select *Select wallpaper* and open an image folder. Scroll to the image that you want to set as wallpaper, press **Options** and select *Set as wallpaper*.

To activate/deactivate the wallpaper, select *On/Off*, respectively.

Note that the wallpaper is not displayed when the phone activates the screen saver.

- Select *Screen saver* to set your phone to display a screen saver when the phone is in standby mode and none of the phone's functions have been used for a certain time.

Select *On* to switch the screen saver on or *Off* to switch it off.

Select in *Time-out* the time after which the screen saver will be activated. In *Other* you can set the length of the timeout from 5 seconds to 10 minutes (minutes:seconds).

With *Select s. saver* you can choose an animation or a still image as the screen saver from *Gallery*.

Press any key to deactivate the screen saver. The screen saver is also deactivated when the phone is out of the network coverage area.

Independent of the screen saver settings, for power saving purposes, a digital clock view will be activated when no function of the phone has been used for a certain time. See Power saving on page 32.

Note that the screen saver overrides all the graphics and texts on the display in standby mode.

- Select *Colour schemes* to change the colour in some display components, for example indicators and signal and battery bars, and the background image that appears when using a menu function.
- Select *Menu view* to set the way the phone displays the main menu. Select *List* for the menu list view and *Grid* for the menu grid view.
- Select *Operator logo* to set your phone to display or hide the operator logo. If you have not saved the operator logo, the *Operator logo* menu is dimmed. The operator logo is not displayed when the phone activates the screen saver.

For more information on the availability of an operator logo, contact your network operator or service provider. See also PC Suite on page 142.

Time and date settings

Press **Menu**, and select *Settings* and *Time and date settings*.

- Select *Clock* and *Show clock* (or *Hide clock*) to show (or hide) the time on the top right of the display in standby mode. Select *Set the time* to adjust the clock to the correct time, *Time zone* to set the time zone, and *Time format* to select the 12-hour or 24-hour time format.

The clock serves the functions *Messages*, *Call register*, *Alarm clock*, timed *Profiles*, *Calendar*, *Notes* and *Screen saver*, for example.

If the battery is removed from the phone or if the battery is empty, you may need to set the time again.

- Select *Date* and *Show date* (or *Hide date*) and the date is shown (or hidden) on the display when the phone is in standby mode. Select *Set the date* to adjust the date. You can also select the date format and date separator.
- Select *Auto-update of date & time* (network service) and *On* to set the phone to automatically update the time and date according to the current time zone. To set the phone to request for a confirmation before the update, select *Confirm first*.

The automatic update of the date and time does not change the time that you have set for the alarm clock, calendar or the alarm notes. They are in local time. Updating may cause some alarms that you have set to expire.

For information on availability, contact your network operator or service provider.

Call settings

Press **Menu**, and select *Settings* and *Call settings*. Select





- *Automatic volume control* and the phone will automatically adjust the speaker volume according to the background noise.
- *Call divert* (network service). With call divert, you can direct your incoming calls to another number, for example, to your voice mailbox number. For details, contact your service provider. Divert options not supported by your SIM card or your network operator may not be shown.

Select the divert option you want, for example, select *Divert if busy* to divert voice calls when your number is busy or when you reject an incoming call.

To set the divert setting to on, select *Activate* and then select the timeout after which the call is diverted, if this is available for the divert option. To set the divert setting to off, select *Cancel*, or select *Check status*, if this is available for the divert option, to check whether call divert is activated or not. Several divert options may be active at the same time.

To see the divert indicators in standby mode, see Standby mode on page 30.

Call barring and call diverting cannot be active at the same time.

- *Anykey answer* and *On* and you can answer an incoming call by briefly pressing any key, except , selection keys  and , and .
- *Automatic redial* and *On* and your phone will make a maximum of ten attempts to connect the call after an unsuccessful call attempt.
- *Speed dialling* and *On* and the names and phone numbers assigned to the speed-dialling keys, from **Z**ABC to **WXYZ**9, can be dialled by pressing and holding the corresponding number key.

- *Call waiting* and *Activate* and the network will notify you of an incoming call while you have a call in progress (network service). See Call waiting on page 37.
- *Summary after call* and *On* and the phone will briefly display the approximate duration and cost (network service) of the call after each call.
- *Send my caller ID* and *Yes* and your phone number will be displayed to the person you are calling (network service). Select *Set by network* and the setting agreed upon with your service provider is used.
- *Line for outgoing calls* which is a network service, to select phone line 1 or 2, that is, the subscriber number, for making calls. For example, you can have a private and a business line. For more information on availability, contact your network operator or service provider.

If you select *Line 2* and have not subscribed to this network service, you will not be able to make calls. However, calls on both lines can be answered regardless of the selected line.

If supported by your SIM card, you can prevent the line selection by selecting the option *Lock*.



Tip: In standby mode and if you have two lines available, you can switch from one line to the other by pressing and holding \uparrow #.

Phone settings

Press *Menu*, and select *Settings, Phone settings*. Select

- *Phone language* to set the display language of your phone. If you select *Automatic* the phone selects the language according to the information on the SIM card.
- *Automatic keypad* to set the keypad of your phone to lock automatically after a pre-set time delay when the phone is in standby mode and no function of the phone has been used. Select *On* and you can set the time from 5 seconds to 60 minutes.

Refer also to Keypad lock (Keyguard) on page 34.

When the keypad is on, calls still may be possible to the official emergency number. Key in the emergency number and press .

- *Cell info display* and *On* to receive information from the network depending on the network cell used (network service).
- *Welcome note* and key in the note you would like to be shown briefly when the phone is switched on. To save the note, press *Save*.
- *Operator selection* and *Automatic* and the phone automatically selects one of the cellular networks available in your area.

If you select *Manual*, you can select a network that has a roaming agreement with your home network operator. If *No network access* is displayed, you must select another network. The phone stays in manual mode until the automatic mode is selected or another SIM card is inserted into the phone.

- *Confirm SIM service actions*. See SIM services on page 141.
- *Help text activation* to set the phone to show or not to show the help texts. See also Using the menu on page 43.
- *Start-up tone* to set the phone to play or not to play a start-up tone when the phone is switched on.

Connectivity

You can define the settings for (E)GPRS dial-up connections.

(E)GPRS

GPRS (General Packet Radio Service) is a network service that allows mobile phones to be used for sending and receiving data over an Internet Protocol (IP)-based network. GPRS is a data bearer that enables wireless access to data networks such as the Internet.

EGPRS (Enhanced GPRS), also known as EDGE (Enhanced Data Rates for Global Evolution), is similar to GPRS. EDGE is a radio interface modulation technique which increases GPRS data rates. For more information on the availability of EGPRS and data transfer speed, contact your network operator or service provider.

The applications that may use (E)GPRS are MMS, Instant messaging, browsing sessions, e-mail, remote SyncML, Java application downloading and the PC dial-up (for example, Internet and e-mail).

Before you can use (E)GPRS technology:

- Contact your network operator or service provider for availability of and subscription to the (E)GPRS service.
- Save the (E)GPRS settings for each of the applications used over (E)GPRS.

For information on pricing, contact your network operator or service provider.

Note that when you have selected GPRS as a data bearer, the phone uses EGPRS instead of GPRS if this is available in the network. You cannot select between EGPRS and GPRS but for some applications you may be able to select either GPRS or *GSM data* (CSD, Circuit Switched Data).

(E)GPRS connection

Press **Menu**, and select *Settings, Connectivity, GPRS* and *GPRS connection*.

- Select *Always online* to set the phone to automatically register to a (E)GPRS network when you switch the phone on. When the (E)GPRS service is available, the indicator  is shown on the top left of the display.

When you start an application using (E)GPRS, the connection between phone and network is established, the indicator  is shown and data transfer is possible. When you end the application, the (E)GPRS connection is ended but the registration to the (E)GPRS network remains.

If you receive a call or a text message, or make a call during a (E)GPRS connection, the indicator  will be shown on the top right of the display to indicate that the (E)GPRS connection is suspended (on hold).

Note that GPRS and EGPRS are not indicated separately, the indicators for GPRS and EGPRS are the same.

- Select *When needed* and the (E)GPRS registration and connection are established when an application using (E)GPRS needs it and closed when you end the application.

(E)GPRS modem settings

You can connect the phone via a data cable connection to a compatible PC and use the phone as a modem to enable (E)GPRS connectivity from the PC.

To define the settings for (E)GPRS connections from your PC, press **Menu**, and select *Settings, Connectivity, GPRS* and *GPRS modem settings*.

- Select *Active access point* and activate the access point that you want to use.
- Select *Edit active access point* to change the access point settings.

- Select *Alias for access point*. Key in the name that you would like for the activated access point and press **OK**.
- Select *GPRS access point*. Key in the Access Point Name (APN) to establish a connection to an (E)GPRS network and press **OK**. Contact your network operator or service provider for the APN.

You can also set the (E)GPRS dial-up service settings (Access Point Name) on your PC using the Nokia Modem Options software, see PC Suite on page 142. If you have set the settings both on your PC and on your phone, note that the PC's settings will be used.

Enhancement settings

The enhancement settings menu is shown only if the phone is or has been connected to a compatible mobile enhancement, chargers and handsfree units, for example.

Press **Menu**, and select *Settings* and *Enhancement settings*. You can select an enhancement menu if the corresponding enhancement is or has been connected to the phone. Depending on the enhancement, you can select some of the following options:

- *Default profile* to select the profile that you want to be automatically activated when you connect to the selected enhancement. You can select another profile while the enhancement is connected.
- *Automatic answer* to set the phone to answer an incoming call automatically after 5 seconds. If the *Incoming call alert* is set to *Beep once* or *Off*, automatic answer will not be in use.
- *Lights* to set the lights permanently *On*. Select *Automatic* to set the lights on for 15 seconds after a keypress.

Configuration settings

Some of the network services, such as mobile Internet services, MMS, Instant messages, E-Mail messages, or Synchronisation need to have the correct configuration settings on your phone. Get the settings from a service provider as a configuration message or key in your personal settings manually. Configuration settings from up to ten different service providers can be stored in the phone and can be managed within this menu.

To save the configuration settings received by a configuration message sent by a service provider, see Configuration settings service on page 18.

The settings can be viewed and partly edited also in the different applications.

Press **Menu**, and select *Settings, Configuration settings*. Select

- *Default configuration settings* to view the list of service providers stored on the phone (the default service provider is highlighted) and to select another service provider as default. Scroll to a provider and press **Details** to view the list with supported applications. To delete a service provider from the list, press **Options** and select *Delete*.
- *Activate default in all applications* to set the applications to use the settings from the default service provider.
- *Preferred access point* to select another access point. Normally the access point from your preferred network operator is to be used.

Keying in the settings manually

To enter, view and edit the settings manually, press **Menu**, and select *Settings, Configuration settings* and *Personal configuration settings*.

To add a new configuration, press **Add new** or press **Options** and select **Add new**. Choose one of the application types from the list and key in all the necessary settings. To activate the settings, press **Back** and **Options** and select **Activate**.

To view or to edit the user-defined settings select the application that you want to view and select the setting to edit.

Security settings

When security features that restrict calls are in use (such as call barring, closed user group and fixed dialling) calls still may be possible to the official emergency number programmed into your device.

Press **Menu**, and select **Settings** and **Security settings**. Select

- **PIN code request** to set the phone to request your PIN code every time the phone is switched on. Some SIM cards do not allow the PIN code request to be turned off.
- **Call barring service** (network service) to restrict incoming calls to and outgoing calls from your phone. A barring password is required.

Call barring and call diverting cannot be active at the same time.

- **Fixed dialling** to restrict your outgoing calls and text messages to selected phone numbers if this function is supported by your SIM card. The PIN2 code is required.

When the fixed dialling is on, (E)GPRS connections are not possible except while sending text messages over an (E)GPRS connection. In this case, the recipient's phone number and the message centre number have to be included on the fixed dialling list.

- **Closed user group**. Closed user group is a network service that specifies the group of people whom you can call and who can call you. For more information contact your network operator or service provider.

- **Security level.** Select *Phone* and the phone will request the security code whenever a new SIM card is inserted into the phone.
Select *Memory* and the phone will request the security code when the SIM card's memory is selected and you want to change the memory in use (see Selecting settings for contacts on page 81) or copy from one memory to another (Copying contacts on page 89).
- **Access codes** to change the security code, PIN code, PIN2 code or barring password. Codes can only include numbers from 0 to 9.

Restore factory settings

To reset some of the menu settings to their original values, press **Menu**, and select *Settings* and *Restore factory settings*. Key in the security code and press **OK**. Note that the data that you have keyed in or downloaded, for example, the names and phone numbers saved in contacts are not deleted.

■ Operator menu

This menu lets you access a portal to services provided by your network operator. This menu is operator specific. The name and the icon depend on the operator. For more information, contact your network operator.

The operator can update this menu with a service message. For more information, refer to Service inbox on page 136.

■ Gallery



In this menu, you can manage graphics, images, video clips, recordings and tones that you have saved, for example, from multimedia messages. These files are arranged in folders.

Your phone supports a Digital Rights Management (DRM) system to protect acquired content. A piece of content, for example a ringing tone, can be protected and associated with certain usage rules, for example number of usage times and a certain usage period. The rules are defined in the content's activation key which can be delivered either together with the content or independently depending on the service provider. You may be able to update these activation keys. Always check the delivery terms of any content and activation key before acquiring them, as they may be subject to a fee.

Copyright protections may prevent some images, ringing tones, and other content from being copied, modified, transferred or forwarded.

1. Press **Menu** and select *Gallery*. A list of folders is shown. *Images*, *Video clips*, *Themes*, *Graphics*, *Tones* and *Recordings* are the original folders on the phone.
2. Scroll to the desired folder and press **Open** to view a list of files in the folder or press **Options** and one of the options may be available:
 - *Downloads* to download more images, tones and videos. Select *Graphic downloads*, *Tone downloads*, *Video downloads* or *Theme downloads*. The list of available browser bookmarks is shown. Select *More bookmarks* to access the list of bookmarks in the *Services* menu, see Bookmarks on page 135.

Select the appropriate bookmark to connect to the desired site. If the connection fails, you may not be able to access the page from the service whose connection settings are currently active. In this case, enter the *Services* menu and activate another set of service settings, see Making a connection to a service on page 131. Try reconnecting to the site.

For availability of different services, pricing and tariffs, contact your network operator and/or the service provider. Download content only from the sources you trust.

- *Delete folder, Move, Rename folder, Details, Type of view, Sort, Add folder* and *Activation key list*. You cannot delete, rename or move the original folders on the phone.
 - *Memory status* to view the status of the second shared memory of the phone. See Shared memory on page 16.
3. If you have opened a folder, select the file that you want to view and press **Open**. If *Themes* was selected before, scroll to a theme and press **View** to open the theme package.

Select and open a file, or press **Options** and use one of the following functions that may be available for the selected file:

- *Delete, Send, Edit image, Move, Rename, Set as wallpaper, Set as ring tone, Apply theme, Details, Type of view, Sort, Delete all, Open in sequence, Mute audio (Unmute audio), Set contrast, Add folder* and *Memory status*.
- *Send* to send the selected file via MMS.
- *Delete all* to delete all the files and folders in the selected folder.
- *Edit image* to insert text, a frame or clip-art into the selected picture or to crop the image.
- *Open in sequence* to view the files in the folder individually.
- *Mute audio (Unmute audio)* to mute (unmute) the sound file.
- *Set contrast* to adjust the contrast level of the image.
- *Activate content* to update the activation key of the selected file. The option is only shown if the activation key of the file can be updated.
- *Activation key list* to view the list of all available activation keys. You can delete the activation keys, for example delete the expired ones.

Media



Camera

You can take photos or record video clips with the phone's built-in camera. The camera lens is on the back of the phone, and the display of the phone works as a viewfinder. The camera produces pictures in JPEG format and the video clips in 3GP format.

If there is not enough memory to take a new photo, you need to free some by deleting old photos or other files in the gallery.

The Nokia 3220 device supports an image capture resolution of 640 x 480 pixels. The image resolution in these materials may appear different.

Taking a photo or a video clip

Press **Menu**, and select **Media, Camera**. The live image appears on the display, and you can use the display as a viewfinder. Press **◀** or **▶** to change the camera mode: **Standard photo**, **Portrait photo** or **Video**, or if the lighting is dim for taking photos to **Night mode**. If you want to add the photo to a name or a phone number saved in contacts, select **Portrait photo**.



Tip: To quickly open the camera viewfinder, press **▲** in standby mode.

- To take a photo, press **Capture**. A shutter sound is heard. The phone saves the photo in the **Images** folder of the **Gallery** menu.

If you want to send the photo as a multimedia message, press **Send**.

Or select **Back** to take another photo, or press **Options** and select, for example, an option to rename or zoom the saved photo or to set the contrast, to see the details, or to set the photo as wallpaper, or to open the gallery, or to delete it.



Tip: You can activate the self-timer of the camera for one picture at a time. Put the camera in photo mode, press **Options** and select *Self-timer*. Press **Start**, and after the timeout, the camera takes the photo. While the self-timer is running, a beeping sound is heard.

- To start recording a video clip, press **Record**. When you are recording a video clip, the remaining recording time is shown on the top of the display.

To pause the recording, press **Pause** and to resume the recording, press **Continue**. To stop the recording, press **Stop**. The phone saves the recording in the *Video clips* folder of the *Gallery* menu. To view the recorded video clip, press **Play**.

Select **Back** to start recording a new video clip, or press **Options** and select, for example, an option to delete or rename the saved video clip, to set the contrast, or to see the details, to send it as a multimedia message, or to open the gallery, or to mute/unmute the microphone.

Camera settings

Press **Menu**, and select *Media, Camera*. Press **Options** and depending on the active camera mode the following options may appear:

- *Change mode* to change the camera mode.
- *Self-timer* to activate the self-timer.
- *Mute/Unmute* to mute or unmute the microphone in the video mode.
- *Open gallery* to open the *Gallery* menu.
- *Settings* to adjust the camera settings:
 - *Default mode* to define the default camera mode.
 - *Image quality* to define how much the photo file will be compressed when saving the image. Select *High, Normal* or *Basic*. *High* provides the best image quality but uses more memory.

- *Video clip length* to select the length of the video clips that you record. The maximum length of a video clip is approximately 50 seconds in duration, depending on conditions. Only video clips that are of default length or shorter can be sent in a multimedia message.
- *Camera sounds* to set the shutter sound and the self-timer tone to *On* or *Off*.
- *Self-timer lights* to set the cover lights to blink according to the rhythm of the self-timer tone.
- *Default title* to define the title that will be used when saving a photo or a video clip. If you select *Automatic*, the default title will be used, or if you select *My title*, you can key in or edit a new title.

Voice recorder

You can record pieces of speech, sound or an active call for up to 3 minutes. For example, this is useful when recording a name and phone number for writing down later.

The recorder cannot be used when a data call or GPRS connection is active.

Recording

1. Press **Menu**, select *Media* and *Voice recorder*.
2. To start the recording, select *Record*. To start the recording during a call, press **Options**, and select *Record*. While recording a call, all parties to the call will hear a faint beeping sound every 5 seconds approximately.
When recording a call, hold the phone in the normal position near to your ear.
3. To end the recording, press **Stop**. The recording will be saved in the *Recordings* folder of the *Gallery* menu.
4. To listen to the latest recording, select *Play last recorded*.
5. To send the latest recording, select *Send last recorded*. The recording can be sent via MMS.

List of recordings

Press **Menu**, and select *Media*, *Voice recorder* and *Recordings list*. The list of folders in the *Gallery* is shown. Open *Recordings* to see the list with recordings. Press **Options** and you can select some of the options for files in the *Gallery*. See *Gallery* on page 109.

■ Organiser



Alarm clock

The alarm clock uses the time format set for the clock. The alarm clock works even when the phone is switched off if there is enough power in the battery.

Press **Menu**, and select *Organiser* and *Alarm clock*.

- Select *Alarm time*, key in the alarm time and press **OK**.
To change the alarm time, select *On*.
- Select *Repeat alarm* to set the phone to alert you on selected days of the week.
- Select *Alarm tone* and select the default alarm tone, personalise the alarm tone by selecting one from the ringing tone list or from *Gallery*.

When the alarm time expires

The phone will sound an alert tone, and flash *Alarm!* and the current time on the display.

Press **Stop** to stop the alarm. If you let the phone continue to sound the alarm for a minute or press **Snooze**, the alarm stops for about 10 minutes and then resumes.

If the alarm time is reached while the device is switched off, the device switches itself on and starts sounding the alarm tone. If you press **Stop**, the device asks whether you want to activate the device for calls. Press **No** to switch

off the device or **Yes** to make and receive calls. Do not press **Yes** when wireless phone use may cause interference or danger.

Calendar

The calendar helps you to keep track of reminders, calls that you need to make, meetings, and birthdays.

The calendar uses shared memory, see Shared memory on page 16.

Press **Menu**, and select *Organiser* and *Calendar*.

 **Tip:** To quickly open the *Calendar* menu, press **▶** in standby mode.

Scroll to the day that you want. The current day is indicated by a frame around the day. If there are any notes set for the day, the day is in bold type. To view the day notes, press **View**. To view a week, press **Options** and select *Week view*.

- To view a single note, scroll to the note that you want to view, press **View**. The note view allows you to view the details of the selected note. You can scroll through the note.
- For example, there are also options for creating a note, or for sending a note directly to another compatible phone's calendar or as a text message or a multimedia message.





There are options for deleting, editing, moving and repeating a note and for copying a note to another day.

To delete all notes in the calendar, select the month or week view, press and select *Delete all notes*. *Settings* to set the date, time, date or time format, or the first day of the week. In the *Auto-delete* option you can set the phone to delete old notes automatically after a specified time. However, the repeat notes, for example, birthday notes, will not be deleted.

Making a calendar note



For keying in letters and numbers, see Writing text on page 39.

Press **Menu**, and select *Organiser* and *Calendar*. Scroll to the date you want, press **Options** and select *Make a note*. Select one of the following note types:

-  *Meeting* - Key in the note (or press **Options** and search for the name in contacts) and press **Save**. Key in the location for the meeting and press **Save**. Enter the start date and time, then enter the end date and end time for the meeting. To set the alarm for the note, select *With tone* or *Silent* (no alarm tone) and then set the alarm time.
-  *Call* - Key in the phone number, press **Save**. Key in the name, press **Save**. (Instead of keying in the phone number, press **Options** to search for the name and number in contacts.) Then enter the time for the call. To set the alarm for the note, select *With tone* or *Silent* (no alarm tone) and then set the alarm time.
-  *Birthday* - Key in the person's name (or press **Options** and search for it in contacts), press **Save**. Then key in the year of birth, and press **OK**. To set the alarm for the note, select *With tone* or *Silent* (no alarm tone) and then set the alarm time.
-  *Memo* - Key in the note, press **Save**. Enter the start and end date for the note. To set the alarm for the note, select *With tone* or *Silent* (no alarm tone) and then set the alarm time.
-  *Reminder* - Key in the subject for the reminder, press **Save**. To set the alarm for the note, select *Alarm on* and then set the alarm time.

When you have set the alarm, the indicator  is displayed when you view the notes.

When the phone sounds an alarm for a note

The phone beeps, and displays the note. With a call note  on the display, you can call the displayed number by pressing .

- To stop the alarm without viewing the note, press **Exit**.
- To stop the alarm and to view the note, press **View**. Press **Snooze** and the phone sounds an alarm again after 10 minutes.

To-do list

You can save a note for a task that you have to do, select a priority level for the note and mark it as done when you have completed it. You can sort the notes by priority or by date.

The to-do list uses shared memory, see Shared memory on page 16.

Press **Menu**, and select *Organiser* and *To-do list*.

Press **Add note** to make a note. Key in the note and press **Save**. Select the priority for the note, *High*, *Medium*, or *Low*. The phone automatically sets the deadline without an alarm for the note. To change the deadline, view the note and select the deadline option.

Or scroll to a note and press **View** or press **Options**.

- To add a new note, select *Add*.
- For example, you can also view and delete the selected note and delete all the notes that you have marked as done. You can sort the notes by priority or by deadline, send a note to another phone, save a note as a calendar note, or access the calendar.

While viewing a note, you can also, for example, select an option to edit the selected note, edit the deadline or priority for the note, or mark the note as done.

Notes

You can use this application for writing and sending notes to compatible devices via MMS.

The Notes application uses shared memory, see Shared memory on page 16.

Press **Menu** and select *Organiser* and *Notes*. The phone will ask you to set the date and time, if they have not already been set when you start to write a note.

To add a note, press **Add note** or press **Options** and select *Make a note*. Key in the note and select **Save**.

Or scroll to a note press **View** or press **Options** to see the options for notes.

Synchronisation

Synchronisation allows you to save your calendar and contacts data on a remote Internet server (network service) or on a compatible PC. If you have saved data on the remote Internet server, you can synchronise your phone by starting the synchronisation from your phone. You can also synchronise the data in your phone's contacts, calendar and notes to correspond to the data of your compatible PC by starting the synchronisation from your PC.



Note: The contact data in your SIM card will not be synchronised.

Answering an incoming call during synchronisation will end the synchronisation and you will need to re-start it.

Synchronising from your phone

Before synchronising from your phone, you need to subscribe to a synchronisation service and get the configuration settings from your provider. For more information on availability and the synchronisation service settings, contact your network operator or service provider.

To start the synchronisation from your phone:

1. Activate the connection settings you need for the synchronisation. See Settings for the synchronisation from your phone on page 119.
2. Press **Menu**, select *Organiser*, *Synchronisation*, *Server sync* and *Data to be synchronised*. Mark the data to be synchronised and press **Done**.
3. Press **Menu**, and select *Organiser*, *Synchronisation*, *Server sync* and *Synchronise*.
4. The marked data of the active set will be synchronised after confirmation.

Note that synchronising for the first time or after an interrupted synchronisation may take up to 30 minutes to complete, if the contacts or calendar are full.

Settings for the synchronisation from your phone

You may receive the synchronisation settings as a configuration message from the network operator or service provider. For more information on availability and the synchronisation service settings, contact your network operator or service provider. For receiving the settings as a configuration message, see Configuration settings service on page 18. To key in the settings manually, see Configuration settings on page 106.

Press **Menu**, select *Organiser*, *Synchronisation* and *Server sync* and *Sync settings*. Select

1. *Configuration* and scroll to the service provider whose settings you would like to activate and press **Select**.
2. *Account* to see the accounts provided by the service provider. If more than one account is displayed choose the one you want to use.

Synchronising from your compatible PC

To synchronise contacts, the calendar and the notes from your compatible PC, use a data cable. You also need the PC Suite software of your phone installed on the PC. Start the synchronisation from the PC using PC suite.

Ensure that the phone is in standby mode and that the time and date are set.

■ Applications



Games and applications

Your phone software may include some games and applications specially designed for this Nokia phone.

Launching a game or an application

Press **Menu**, and select *Applications*, *Games* and *Select game*, or *Collection* and *Select application*. Scroll to a game or an application and press **Open** or press .

Note that running some games or applications may consume the phone's battery faster (and you may need to connect the phone to the charger).

Options available for a game or an application

Press **Menu**, and select *Applications*, *Games* or *Collection*. Scroll to a game or an application and press **Options**. The following options may be available:

- *Delete* to delete the game or application from the phone.

Note that if you delete a pre-installed game or application from your phone, you may download it again to your phone from the support area on the Nokia website www.nokia.com.

- *Details* to give additional information about the game or application.
- *Update version* to check if a new version is available for download from the services (network service).
- *Web page* to provide further information or additional data from an Internet page. This feature needs to be supported by the network. It is only shown if an Internet address has been provided with the game or application.
- *App. access* to restrict the game or application from accessing the network to prevent you from accruing unexpected costs. Select *Communication* and *Network access*, *Messaging* or *Connectivity*, or select *Phone access* or *Auto-start*. Select in each category, if available, one of the following permissions:
 - *Ask every time* and the phone asks always for net access.
 - *Ask first time only* and the phone asks on first attempt at net access.
 - *Always allowed* to allow net access.
 - *Not allowed* to disallow net access.

Downloading a game or an application

Your phone supports J2ME™ Java applications. Make sure that the application is compatible with your phone before downloading it.



Important: Only install applications from sources that offer adequate protection against harmful software.

You can download new Java applications in different ways:

- Press **Menu**, and select *Applications*, *Games* and *Game downloads*, or *Collection* and *App. downloads* and the list of available bookmarks is shown. Select *More bookmarks* to access the list of bookmarks in the *Services* menu, see Bookmarks on page 135.

Select the appropriate bookmark to connect to the desired page. If the connection fails, you may not be able to access the page from the service whose connection settings are currently active. In this case, enter the *Services* menu and activate another set of service settings, see Making a connection to a service on page 131. Try again to connect to the page.

For the availability of different services, pricing and tariffs, contact your network operator and/or the service provider.

- Press **Menu**, and select *Services* and *Download links*. See Downloading on page 136.
- Use the Nokia Application installer from PC Suite to download the applications in your phone.



Note that Nokia does not warrant for applications from non-Nokia sites. If you choose to download Java applications from them, you should take the same precautions, for security or content, as you would with any site.

Note that when downloading an application, it may be saved in the *Games* menu instead of the *Applications* menu.

Game settings

Press **Menu**, and select *Applications, Games* and *App. settings* to set sounds, lights and shakes for games.

Memory status for games and applications

To view the amount of memory available for game and application installations (third shared memory), press **Menu**, and select *Applications, Games* or *Collection* and then *Memory*.

The games and applications use shared memory, see Shared memory on page 16.

Calculator

The calculator in your phone adds, subtracts, multiplies, divides, calculates the square and the square root and converts currency values.



Note: This calculator has limited accuracy and is designed for simple calculations.

1. Press **Menu**, and select *Applications, Extras* and *Calculator*.
2. When '0' is displayed on the screen, key in the first number in the calculation, press **▲ #** for a decimal point.
3. Press **Options** and select *Add, Subtract, Multiply, Divide, Square, Square root* or *Change sign*.



Tip: Alternatively, press *** +** once to add, twice to subtract, three times to multiply or four times to divide.

4. Key in the second number.
5. To get the answer, press **Equals**. Repeat steps 3 to 5 as many times as is necessary.
6. To start a new calculation, first press and hold **Clear**.

Performing a currency conversion

1. Press **Menu**, and select *Applications, Extras* and *Calculator*.
2. To save the exchange rate, press **Options** and select *Exchange rate*. Select either of the displayed options. Key in the exchange rate, press **⇧ #** for a decimal point, and press **OK**. The exchange rate remains in the memory until you replace it with another one.
3. To perform the currency conversion, key in the amount to be converted, press **Options** and select *In domestic* or *In foreign*.



Note: When you change base currency, you must key in the new rates because all previously set exchange rates are set to zero.



Tip: You can also perform the currency conversion in standby mode. Key in the amount to be converted, press **Options** and select *In domestic* or *In foreign*.

Countdown timer

Press **Menu**, and select *Applications, Extras* and *Countdown timer*. Key in the alarm time in hours, minutes and seconds and press **OK**. If you wish, write your own note text which is displayed when the time expires, and press **Start** to start the countdown timer.

- To change the countdown time, select *Change time*, or to stop the timer, select *Stop timer*.

If the alarm time is reached when the phone is in standby mode, the phone sounds a tone and flashes the note text if it is set or else *Countdown time up*. Stop the alarm by pressing any key. If no key is pressed, the alarm automatically stops within 30 seconds. To stop the alarm and to delete the note text, press **Exit**.

Stopwatch

You can measure time, take intermediate times or lap times using the stopwatch. During timing, the other functions of the phone can be used. To set the stopwatch timing in the background, press .

Using the stopwatch or allowing it to run in the background when using other features increases the demand on battery power and reduces the battery life.

Time observation and time splitting

1. Press **Menu**, and select *Applications*, *Extras*, *Stopwatch* and *Split timing*. You can select *Continue* if you have set the timing in the background.
2. Press **Start** to start the time observation. Press **Split** every time you want to take an intermediate time. The intermediate times are listed below the running time on the display. Scroll to view the times.
3. Press **Stop** to stop the time observation.
4. To save the times, press **Save** and enter a name.

Or press **Options** and select *Start* to start the time observation again. The new time is added to the previous time. Select *Reset* to reset the time without saving it.

Lap times

Press **Menu**, and select *Applications*, *Extras*, *Stopwatch* and *Lap timing*. Press **Start** to start the time observation and **Lap** to take a lap time. Press **Stop** to stop the lap timing. To save the times, press **Save** and enter a name. Or press **Options** and you can start or reset the lap times. Refer to Time observation and time splitting on page 125.

Viewing and deleting times

Press **Menu**, and select *Applications*, *Extras* and *Stopwatch*.

If the stopwatch is not reset, you can select *Show last* to view the most recent measured time. Select *View times* and a list of names or final times of the time sets is shown, select the time set that you want to view.

To delete the saved times, select *Delete times*. Select *Delete all* and press **OK**, or select *One by one*, scroll to the times you want to delete, press **Delete** and press **OK**.

Wallet

In *Wallet* you can save personal information, for example, credit card numbers and addresses. The data that are saved in the wallet can easily be retrieved while browsing to automatically fill in data fields, for example, when making purchases and the service supports wallet functionality. You can also save access codes to mobile services that request a user name and password.

The data in the wallet are protected with a wallet code that you can define when you access wallet for the first time. At *Create wallet code*: key in the code and press **OK** to confirm it and at *Verify wallet code*: key in the code again and press **OK**. See also *Wallet code (4 to 10 digits)* on page 17.

If you want to delete all the content of the wallet and the wallet code, key in **#7370925538#* (**#res wallet#* in letters) in standby mode. You also need the phone's security code, see *Access codes* on page 16.

To add the content into the wallet menu, and to edit it, access the wallet menu. To use the content of the wallet in a mobile service, access the wallet via the browser, see *Services* on page 130.

Accessing the wallet menu

To access the wallet menu, press **Menu**, select *Applications*, *Extras* and *Wallet*. Key in your wallet code and press **OK**, see *Wallet settings* on page 129. Select

- *Wallet profiles* to create card combinations, for example, for different services. A wallet profile is helpful if the service asks for many data items to be filled in. You can select the appropriate wallet profile instead of selecting different cards separately.
- *Cards* to save personal card information. You can save payment card, loyalty card and access card information, for example username and password combinations for different services, and also addresses and user data. See *Saving card details* on page 127.
- *Tickets* to save the notifications of e-tickets that you have bought via a mobile service. To view the tickets, press **Options** and select *View*.
- *Receipts* to save receipts of mobile purchases.
- *Personal notes* to save all kinds of personal information that you want to keep protected by the wallet PIN code. See *Personal notes* on page 128.
- *Settings*, see *Wallet settings* on page 129.

Saving card details

Access the wallet and select *Cards*. Select the card type to save details: *Payment cards*, *Loyalty cards*, *Access cards*, *User info cards*, or *Address cards*. If no card is added, press **Add new**, otherwise, press **Options** and select *Add new*. Fill in the fields for the details and press **Done**.

If supported by your service provider, you can also receive card information to your phone as a configuration message. You will be notified as to which category the card belongs to. For availability of receiving card information as configuration settings, contact the card issuer or service provider.

Personal notes

You can save personal notes, for example, account numbers, passwords, codes or notations.

Access the wallet and select *Personal notes*. Press **Options** and you can view, add, edit a selected note and sort notes either by name or date or delete notes. When viewing a note, you can edit or delete the selected note. The option *Send via text msg.* is for copying the note as a text message and *Copy to calendar* is for copying the note to the calendar as a memo. *Use detail* is for extracting numbers, e-mail addresses and web addresses from a note.

Creating a wallet profile

When you have saved your personal card details, you can combine them together into a wallet profile. You can use the profile to retrieve wallet data from different cards while browsing.

1. Access the wallet and select *Wallet profiles*.
2. To create a new wallet profile if no profile is added, press **Add new**. Otherwise, press **Options** and select *Add new*.
3. Fill in the following fields and press **Done**. Some of the fields contain data that are selected from the wallet. You need to save those data before you can create a wallet profile.
 - *Select payment card next* - select a card from the payment card list.
 - *Select loyalty card next* - select a card from the loyalty card list.
 - *Select access card next* - select a card from the access card list.
 - *Select user info card next* - select a card from the user data card list.
 - *Select billing address next* - select an address from the address card list.
 - *Select shipping address next* - select an address from the address card list.
 - *Select receipt delivery address next* - select an address from the address card list.

- *Select receipt delivery method next* - select how the receipt is to be delivered, *To phone number* or *To e-mail address*.
- *Wallet profile name*: enter a name for the profile.

Some of the fields contain data that are selected from the wallet. You need to save those data before you can create a wallet profile.

Wallet settings

Access the wallet and select *Settings*. Select *Change code* to change the wallet code. Select *RFID* to set the RFID ID with the *RFID code* and *RFID type*. (RFID = Radio Frequency Identification, technology to securely conduct commercial transactions using your phone).

Guidelines for paying for your purchases with the wallet

- To do your shopping, access the desired service site that supports the wallet. The service needs to support the Electronic Commerce Modeling Language specification. See Making a connection to a service on page 131.

Choose the product that you want to buy and carefully read all information provided before your purchase.

The text may not fit within a single screen. Therefore, make sure to scroll through and read all of the text before your purchase.

- To pay for the items that you wish to buy, the phone asks whether you want to use wallet or not. The phone also asks for your wallet PIN code.
- Select the card that you want to pay with from the Payment cards list. Provided that the data form you receive from the service provider supports the Electronic Commerce Modeling Language specification, the phone automatically fills in the credit card information or the wallet profile from the wallet.

- Approve the purchase, and the information is forwarded.
- You may receive an acknowledgement or a digital receipt of the purchase.
- To close the wallet, select *Close wallet*. If you do not use the wallet for 5 minutes, it will be automatically closed.

A cache is a memory location that is used to store data temporarily. If you have tried to access or have accessed confidential information requiring passwords, empty the cache after each use. The information or services you have accessed is stored in the cache.

To empty the cache, see The cache memory on page 137.

■ Services

You can access various mobile Internet services with your phone's browser. These services may include for example, weather reports, news or flight times and financial information.



Check the availability of these services, pricing and tariffs with your network operator and/or the service provider whose service you wish to use. Service providers will also give you instructions on how to use their services.

With your phone's browser you can view the services that use Wireless Mark-Up Language (WML) or extensible HyperText Mark-up Language (xHTML) on their pages. Appearance may vary due to screen size. Note that you may not be able to view all the details of the Internet pages.

Basic steps for accessing and using services

1. Save the service settings that are required to access the service that you want to use. See page 131.
2. Make a connection to the given service. See page 131.

3. Start browsing the pages of the service. See page 132.
4. Once you are finished browsing, end the connection to the service. See page 134.

Setting up the phone for a service

Your phone may have stored some service settings. Additional settings may be received as a configuration message from the network operator or service provider that offers the service that you want to use.

To receive the service settings as a configuration message, see Configuration settings service on page 18 and Configuration settings on page 106.

For more information and for the appropriate settings, contact the network operator or service provider that offers the service that you want to use.

Making a connection to a service

1. Make sure that the service settings of the service you want to use are activated. To activate the settings:

Press **Menu**, and select *Services*, *Settings* and *Configuration settings*. Select *Configuration* and select the configuration set you want to activate.

2. Make a connection to the service. There are three ways to connect:

- Open the start page, for example, the homepage of the service provider:

Press **Menu**, and select *Services* and *Home*, or in standby mode press and hold .

- Select a bookmark of the service:



Press **Menu**, and select *Services*, *Bookmarks*, and select a bookmark.

If the bookmark does not work with the current active service settings, activate another set of service settings and try again.





- Select the last URL:
Press **Menu**, and select *Services, Last web addr.*
- Key in the address of the service:
Press **Menu**, and select *Services* and then *Go to address*. Key in the address of the service and press **OK**.

Browsing the pages of a service

After you have made a connection to the service, you can start browsing its pages. The function of the phone keys may vary in different services. Follow the text guides on the phone display. For more information, contact your service provider.

Note that if GPRS is selected as the data bearer, the indicator  is shown on the top left of the display during browsing. If you receive a call or a text message, or make a call during an (E)GPRS connection, the indicator  will be shown on the top left of the display to indicate that the (E)GPRS connection is suspended (on hold). After a call, for example, the phone tries to reconnect the (E)GPRS connection.

Using the phone keys while browsing

- Use any of the scroll keys to browse through the page.
- To select a highlighted item, press , or press **Options** to select the option for opening the link.
- To enter letters and numbers, press the keys   - *wxyz*  and to enter special characters, press the key ***+.**

Options while browsing

Press **Options** and the following options may be available. The service provider may also offer other options. Select

- *Shortcuts* to open a new list of options that are, for example, specific to the page.
- *Home* to open the home page of the selected service provider.
- *Add bookmark* to save the page as a bookmark.
- *Bookmarks*. See Bookmarks on page 135.
- *History* to get a list showing last visited URLs.
- *Download links* to show the list of bookmarks for downloading.
- *Save to folder* to save the current page to a download folder.
- *Other options* to show a list of other options, for example options for some security options.
- *Reload* to reload and update the current page.
- *Quit*. See Disconnect from a service on page 134.



A cache is a memory location that is used to store data temporarily. If you have tried to access or have accessed confidential information requiring passwords, empty the cache after each use. The information or services you have accessed is stored in the cache. To empty the cache, see The cache memory on page 137.

Direct calling

The browser supports functions that you can access while browsing. You can make a voice call, send DTMF tones while a voice call is in progress, and save a name and a phone number from a page.

Disconnect from a service

To quit browsing and to end the connection, press **Options** and select *Quit*. When *Quit browsing?* is shown, press **Yes**.

Alternatively, press  twice, or press and hold .

Appearance settings of the browser

While browsing, press **Options** and select *Other options* and *Appear. settings*, or in standby mode, press **Menu**, and select *Services*, *Settings* and *Appearance settings*. Select

- *Text wrapping*. Select *On* and the text continues on the next line. If you select *Off*, the text will be abbreviated.
- *Font size* and choose a size.
- *Show images*. Select *No* and any pictures appearing on the page are not shown. This can speed up the browsing of pages that contain a lot of pictures.
- *Alerts* and select *Alert for unsecure connection* and *Yes* to set the phone to alert when a secure connection changes to an insecure one during browsing. Select *Alert for unsecure items* and *Yes* to set the phone to alert when a secure page contains an insecure item. Note that these alerts do not guarantee a secure connection. For more information, see Browser security on page 138.
- *Character encoding* to select the character set that the phone uses for showing browser pages that do not include that information or to select whether to always use UTF-8 encoding when sending a Web address to a compatible phone.

Cookies

A cookie is data that a site saves in your phone's browser cache memory. The data can be, for example, your user information or your browsing preferences. Cookies will be saved until you clear the cache memory, see The cache memory on page 137.

1. While browsing, press **Options** and select *Other options*, *Security* and *Cookie settings*, or in standby mode, press **Menu**, and select *Services*, *Settings*, *Security settings* and *Cookies*.
2. Select *Allow* or *Reject* to allow the phone to or prevent the phone from receiving cookies.

Bookmarks

You can save page addresses as bookmarks in the phone's memory.

1. While browsing, press **Options** and select *Bookmarks*, or in standby mode, press **Menu**, and select *Services* and *Bookmarks*.
2. Scroll to the bookmark that you want to use and press **Select** to make a connection to the page associated with the bookmark.

Or select **Options** to view the title and the address of the selected bookmark, edit or delete the selected bookmark, or send it directly to another phone as a bookmark, or as a text message, or create a new bookmark.

Your device may have some bookmarks loaded for sites not affiliated to Nokia. Nokia does not warrant or endorse these sites. If you choose to access them, you should take the same precautions, for security or content, as you would with any Internet site.

Receiving a bookmark

When you have received a bookmark (sent as a bookmark) *1 bookmark received* is displayed. Press **Show** to view the bookmark. To save the bookmark, press **Save**, or press **Options** and select **View** to see the details or **Delete** to discard it. To discard the bookmark directly after you have received the bookmark, press **Exit** and **OK**.

Downloading

To download more tones, graphics, games, videos, themes or applications to your phone (network service), press **Menu**, and select *Services* and *Download links*.

Select *Tone downloads*, *Graphic downloads*, *Game downloads*, *Video downloads*, *Theme downloads* or *App. downloads*.



Important: Only install applications from sources that offer adequate protection against harmful software.

For the availability of different services, pricing and tariffs, contact your network operator and/or service provider.

Service inbox

The phone is able to receive service messages (pushed messages) sent by your service provider (network service). Service messages are notifications of, for example, news headlines, and they may contain a text message or an address of a service.

To access the *Service inbox* in standby mode, when you have received a service message, press **Show**.

If you press **Exit** the message is moved to the *Service inbox*. To access the *Service inbox* later, press **Menu**, and select *Services* and *Service inbox*.

To access the *Service inbox* while browsing, press **Options** and select *Other options* and *Service inbox*. Scroll to the message that you want, press **Retrieve** to activate the browser and download the marked content, or press **Options** and select *Details* to display detailed information on the service notification, or select *Delete* to delete it.

Service inbox settings

Press **Menu**, and select *Services*, *Settings* and *Service inbox settings*.

- Select *Service messages* and *On* (or *Off*) to set the phone to receive (or not to receive) service messages.
- Select *Message filter* and *On* to set the phone to receive service messages only from content authors approved by the service provider. To view the list of the approved content authors, select *Trusted channels*.
- Select *Automatic connection*. If you have set the phone to receive service messages and select *On*, the phone will automatically activate the browser from standby mode when the phone has received a service message.

If you select *Off*, the phone will activate the browser only after you have selected *Retrieve* when the phone has received a service message.

The cache memory

The information or services that you have accessed are stored in the cache of your phone. A cache is a buffer memory, which is used to store data temporarily. To empty the cache:

- while browsing, press **Options** and select *Other options* and *Clear the cache*, or
- in standby mode, press **Menu**, and select *Services*, and *Clear the cache*.

Browser security

Security features may be required for some services, such as banking services or online shopping. For such connections you need security certificates and possibly a security module which may be available on your SIM card. For more information, contact your service provider.

Security module

The security module can contain certificates as well as private and public keys. The purpose of the security module is to improve security services for applications requiring browser connection, and it allows you to use a digital signature. The certificates are saved in the security module by the service provider.

Press **Menu** and select *Services*, *Settings*, *Security settings* and *Security module settings*. Select

- *Security module details* to show the security module title, its status, manufacturer and serial number.
- *Module PIN request* to set the phone to request the module PIN when using services provided by security module. Key in the code and select *On*. To disable the module PIN request, select *Off*.
- *Change module PIN* to change the module PIN, if allowed by the security module. Enter the current module PIN code, then enter the new code twice.
- *Change signing PIN*. Select the signing PIN that you want to change. Enter the current PIN code, then enter the new code twice.

See also Access codes on page 16.

Certificates

There are three kinds of certificates: server certificates, authority certificates and user certificates.

- The phone uses a server certificate to create a connection with improved security to the content server. The phone receives the server certificate from the service provider before the connection is established and its validity is checked using the authority certificates saved in the phone. Server certificates are not saved.

The security indicator  is displayed during a connection if the data transmission between the phone and the content server is encrypted.

The security icon does not indicate that the data transmission between the gateway and the content server (or place where the requested resource is stored) is secure. The service provider secures the data transmission between the gateway and the content server.

- Authority certificates are used by some services, such as banking services, for checking the validity of other certificates. Authority certificates can either be saved in the security module by the service provider, or they can be downloaded from the network, if the service supports the use of authority certificates.
- User certificates are issued to users by a Certifying Authority. User certificates are required, for example, to create a digital signature and they associate the user with a specific private key in a security module.



Important: Note that even if the use of certificates makes the risks involved in remote connections and software installation considerably smaller, they must be used correctly in order to benefit from increased security. The existence of a certificate does not offer any protection by itself; the certificate manager must contain correct, authentic, or trusted certificates for increased security to be available. Certificates have a restricted lifetime. If Expired certificate or Certificate not valid yet is shown even if the certificate should be valid, check that the current date and time in your device are correct.

Before changing any certificate settings, you must make sure that you really trust the owner of the certificate and that the certificate really belongs to the listed owner.

Digital signature

You can make digital signatures with your phone if your SIM card has a security module. The signature can be traced back to you via the private key on the security module and the user certificate that was used to perform the signature. Using the digital signature can be the same as signing your name to a paper bill, contract or other document.

To make a digital signature, select a link on a page, for example, the title of the book that you want to buy and its price. The text to sign (possibly including amount, date, etc.) will be shown.

Check that the header text is *Read* and that the digital signature icon  is shown.



Note: If the digital signature icon does not appear, there is a security breach, and you should not enter any personal data such as your signing PIN.

To sign the text, read all of the text first and then you can select **Sign**.

The text may not fit within a single screen. Therefore, make sure to scroll through and read all of the text before signing.

Select the user certificate you want to use. Key in the signing PIN (see General information on page 14) and press **OK**. The digital signature icon will disappear, and the service may display a confirmation of your purchase.

■ SIM services

In addition to the functions available on the phone, your SIM card may provide additional services that you can access in this menu which is shown only if it is supported by your SIM card. The name and contents of the menu depend on the SIM card.



For availability, rates and information on using SIM services, contact your SIM card vendor, e.g. network operator, service provider or other vendor.

Depending on the operator you can set the phone to show you the confirmation messages sent between your phone and the network when you are using the SIM services by selecting the option *Yes* within the menu *Confirm SIM service actions*, in *Phone settings*.

Note that accessing these services may involve sending messages or making a phone call for which you may be charged.

7. PC Connectivity

You can send and receive e-mails, and access the Internet when your phone is connected to a compatible PC via a data cable connection. You can use your phone with a variety of PC connectivity and data communications applications. With PC Suite you can, for example, synchronise contacts, calendar and notes between your phone and the compatible PC or a remote Internet server (network service).

You may find more information and downloadable files, for example PC suite, in the support area on the Nokia website, www.nokia.com.

■ PC Suite

PC Suite contains the following applications (in alphabetical order):

- **HTML Help** to support the application usage.
- **Nokia 3220 data modem drivers** enable you to use your phone as a modem.
- **Nokia Application Installer** to install J2ME Java applications from a compatible PC to the phone, for example games and dictionaries.
- **Nokia Connection Manager** to select the connection type between the PC and phone.
- **Nokia Contacts Editor** to edit contacts in your phone.
- **Nokia Content Copier** to back-up and restore personal data between your phone and a compatible PC. Supports also content transfer to another compatible Nokia phone.
- **Nokia Image Converter** to make images in supported formats usable for multimedia messages or wallpaper and to transfer them to your phone.

- **Nokia Modem Options** contains settings for HSCSD and GPRS connections.
- **Nokia Multimedia Player** to for playing sounds, images, videos and multimedia messages on the PC. Multimedia Player allows you to view multimedia received on your phone or via e-mail.
- **Nokia PC Sync** to synchronise contacts, calendar and to-do notes between your phone and a compatible PC.
- **Nokia Phone Browser** to view the contents of the Gallery folder of your phone on a compatible PC. You can browse picture and audio files and also modify files in the phone's memory and transfer files between your phone and PC.
- **Nokia Phone Editor** to send text messages and edit the contacts in your phone.
- **Nokia Sound Converter** to optimise polyphonic ringing tones in supported formats to be compatible with your phone and to transfer them to your phone.

Copyright protections may prevent some images, ringing tones, and other content from being copied, modified, transferred or forwarded.

(E)GPRS, HSCSD and CSD

With your phone you can use the (E)GPRS (Enhanced GPRS), GPRS (General Packet Radio Service), HSCSD (High Speed Circuit Switched Data) and CSD (Circuit Switched Data, *GSM data*) data services.

For availability and subscription to data services, contact your network operator or service provider.

Note that the use of HSCSD services consumes the phone's battery faster than normal voice or data calls. You may need to connect the phone to a charger for the duration of the data transfer.

See (E)GPRS modem settings on page 104.

■ Using data communication applications

For information on using a data communication application, refer to the documentation provided with it.

Note that making or answering phone calls during a computer connection is not recommended as it might disrupt the operation.

For better performance during data calls, place the phone on a stationary surface with the keypad facing downward. Do not move the phone by holding it in your hand during a data call.

8. Battery information

■ Charging and Discharging

Your device is powered by a rechargeable battery. The full performance of a new battery is achieved only after two or three complete charge and discharge cycles. The battery can be charged and discharged hundreds of times but it will eventually wear out. When the talk and standby times are noticeably shorter than normal, buy a new battery. Use only Nokia approved batteries, and recharge your battery only with Nokia approved chargers designated for this device.

Unplug the charger from the electrical plug and the device when not in use. Do not leave the battery connected to a charger. Overcharging may shorten its lifetime. If left unused, a fully charged battery will lose its charge over time. Temperature extremes can affect the ability of your battery to charge.

Use the battery only for its intended purpose. Never use any charger or battery that is damaged.

Do not short-circuit the battery. Accidental short-circuiting can occur when a metallic object such as a coin, clip, or pen causes direct connection of the positive (+) and negative (-) terminals of the battery. (These look like metal strips on the battery.) This might happen, for example, when you carry a spare battery in your pocket or purse. Short-circuiting the terminals may damage the battery or the connecting object.

Leaving the battery in hot or cold places, such as in a closed car in summer or winter conditions, will reduce the capacity and lifetime of the battery. Always try to keep the battery between 15°C and 25°C (59°F and 77°F). A device with a hot or cold battery may not work temporarily, even when the battery is fully charged. Battery performance is particularly limited in temperatures well below freezing.

Do not dispose of batteries in a fire! Dispose of batteries according to local regulations. Please recycle when possible. Do not dispose as household waste.

CARE AND MAINTENANCE

Your device is a product of superior design and craftsmanship and should be treated with care. The suggestions below will help you protect your warranty coverage.

- Keep the device dry. Precipitation, humidity and all types of liquids or moisture can contain minerals that will corrode electronic circuits. If your device does get wet, remove the battery and allow the device to dry completely before replacing it.
- Do not use or store the device in dusty, dirty areas. Its moving parts and electronic components can be damaged.
- Do not store the device in hot areas. High temperatures can shorten the life of electronic devices, damage batteries, and warp or melt certain plastics.
- Do not store the device in cold areas. When the device returns to its normal temperature, moisture can form inside the device and damage electronic circuit boards.
- Do not attempt to open the device other than as instructed in this guide.
- Do not drop, knock, or shake the device. Rough handling can break internal circuit boards and fine mechanics.
- Do not use harsh chemicals, cleaning solvents, or strong detergents to clean the device.
- Do not paint the device. Paint can clog the moving parts and prevent proper operation.
- Use a soft, clean, dry cloth to clean any lenses (such as camera, proximity sensor, and light sensor lenses).
- Use only the supplied or an approved replacement antenna. Unauthorised antennas, modifications, or attachments could damage the device and may violate regulations governing radio devices.

All of the above suggestions apply equally to your device, battery, charger, or any enhancement. If any device is not working properly, take it to the nearest authorized service facility for service.

ADDITIONAL SAFETY INFORMATION

■ Traffic Safety

Do not use a hand-held telephone while driving a vehicle. Always secure the phone in its holder; do not place the phone on the passenger seat or where it can break loose in a collision or sudden stop.

Remember road safety always comes first!

■ Operating environment

Remember to follow any special regulations in force in any area and always switch off your device when its use is prohibited or when it may cause interference or danger. Use the device only in its normal operating positions. To maintain compliance with radio frequency exposure guidelines only use enhancements approved by Nokia for use with this device. When the device is on and being worn on the body, always use an approved holder or carrying case.

Parts of the device are magnetic. Metallic materials may be attracted to the device, and persons with a hearing aid should not hold the device to the ear with the hearing aid. Always secure the device in its holder, because metallic materials may be attracted by the earpiece. Do not place credit cards or other magnetic storage media near the device, because information stored on them may be erased.

■ Medical devices

Operation of any radio transmitting equipment, including wireless phones, may interfere with the functionality of inadequately protected medical devices. Consult a physician or the manufacturer of the medical device to determine if they are adequately shielded from external RF energy or if you have any questions. Switch off your device in health care facilities when any regulations posted in these areas instruct you to do so. Hospitals or health care facilities may be using equipment that could be sensitive to external RF energy.

Pacemakers

Pacemaker manufacturers recommend that a minimum separation of 6 in. (15.3 cm) be maintained between a wireless phone and a pacemaker to avoid potential interference with the pacemaker. These recommendations are consistent with the independent research by and recommendations of Wireless Technology Research. Persons with pacemakers should:

- always keep the device more than 6 in. (15.3 cm) from their pacemaker when the device is switched on;
- not carry the device in a breast pocket; and
- hold the device to the ear opposite the pacemaker to minimise the potential for interference.

If you have any reason to suspect that interference is taking place, switch off your device immediately.

Hearing aids

Some digital wireless devices may interfere with some hearing aids. If interference occurs, consult your service provider.

■ Vehicles

RF signals may affect improperly installed or inadequately shielded electronic systems in motor vehicles such as electronic fuel injection systems, electronic antiskid (antilock) braking systems, electronic speed control systems, air bag systems. For more information, check with the manufacturer or its representative of your vehicle or any equipment that has been added.

Only qualified personnel should service the device, or install the device in a vehicle. Faulty installation or service may be dangerous and may invalidate any warranty that may apply to the device. Check regularly that all wireless device equipment in your vehicle is mounted and operating properly. Do not store or carry flammable liquids, gases, or explosive materials in the same compartment as the device, its parts, or enhancements. For vehicles equipped with an air bag, remember that air bags inflate with great force. Do not place objects, including installed or portable wireless equipment in the area over the air bag or in the air bag deployment area. If in-vehicle wireless equipment is improperly installed and the air bag inflates, serious injury could result.

Using your device while flying in aircraft is prohibited. Switch off your device before boarding an aircraft. The use of wireless teledevices in an aircraft may be dangerous to the operation of the aircraft, disrupt the wireless telephone network, and may be illegal.

■ Potentially explosive environments

Switch off your device when in any area with a potentially explosive atmosphere and obey all signs and instructions. Potentially explosive atmospheres include areas where you would normally be advised to turn off your vehicle engine. Sparks in such areas could cause an explosion or fire resulting in bodily injury or even death. Switch off the device at refuelling points such as near gas pumps at service stations. Observe restrictions on the use of radio equipment in fuel depots, storage, and distribution areas, chemical plants or where blasting operations are in progress. Areas with a potentially explosive atmosphere are often but not always clearly marked. They include below deck on boats, chemical transfer or storage facilities, vehicles using liquefied petroleum gas (such as propane or butane), and areas where the air contains chemicals or particles such as grain, dust or metal powders.



■ Emergency calls



Important:

Wireless phones, including this device, operate using radio signals, wireless networks, landline networks, and user-programmed functions. Because of this, connections in all conditions cannot be guaranteed. You should never rely solely on any wireless device for essential communications like medical emergencies.

To make an emergency call:

1. If the device is not on, switch it on. Check for adequate signal strength.
Some networks may require that a valid SIM card is properly inserted in the device.
2. Press  as many times as needed to clear the display and ready the device for calls.
3. Key in the official emergency number for your present location. Emergency numbers vary by location.
4. Press the  key.

If certain features are in use, you may first need to turn those features off before you can make an emergency call. If the device is in offline or flight mode you must change the profile to activate the phone function before you can make an emergency call. Consult this guide or your service provider for more information.

When making an emergency call, give all the necessary information as accurately as possible. Your wireless device may be the only means of communication at the scene of an accident. Do not end the call until given permission to do so.

■ Certification information (SAR)

THIS DEVICE MEETS INTERNATIONAL GUIDELINES FOR EXPOSURE TO RADIO WAVES

Your mobile device is a radio transmitter and receiver. It is designed and manufactured not to exceed the limits for exposure to radio frequency (RF) recommended by international guidelines (ICNIRP). These limits are part of comprehensive guidelines and establish permitted levels of RF energy for the general population. The guidelines were developed by independent scientific organisations through periodic and thorough evaluation of scientific studies. The guidelines include a substantial safety margin designed to assure the safety of all persons, regardless of age and health.

The exposure standard for mobile devices employs a unit of measurement known as the Specific Absorption Rate, or SAR. The SAR limit stated in the international guidelines is 2.0 W/kg*. Tests for SAR are conducted using standard operating positions with the device transmitting at its highest certified power level in all tested frequency bands. Although the SAR is determined at the highest certified power level, the actual SAR of the device while operating can be well below the maximum value. This is because the device is designed to operate at multiple power levels so as to use only the power required to reach the network. In general, the closer you are to a base station, the lower the power output of the device.

The highest SAR value for this device when tested for use at the ear is 0.78 W/kg.

This device meets RF exposure guidelines when used either in the normal use position against the ear or when positioned at least 2.2 cm away from the body. When a carry case, belt clip or holder is used for body-worn operation, it should not contain metal and should position the product at least 2.2 cm away from your body.

In order to transmit data files or messages, this device requires a quality connection to the network. In some cases, transmission of data files or messages may be delayed until such a connection is available. Ensure the above separation distance instructions are followed until the transmission is completed.

* The SAR limit for mobile devices used by the public is 2.0 watts/kilogram (W/kg) averaged over ten grams of body tissue. The guidelines incorporate a substantial margin of safety to give additional protection for the public and to account for any variations in measurements. SAR values may vary depending on national reporting requirements and the network band. For SAR information in other regions please look under product information at www.nokia.com.

