

Bedienungsanleitung
Operating Instructions
Instructions d'emploi
Instrucciones de servicio
Manual de instruções
Istruzioni d'uso
Gebruiksaanwijzing
Betjeningsvejledning
Bruksanvisning
Brukerveiledningen
Käyttöohje
Οδηγία χειρισμού
Kullanım kılavuzu

BOSCH

AHM 30
AHM 38
AHM 30C
AHM 38C

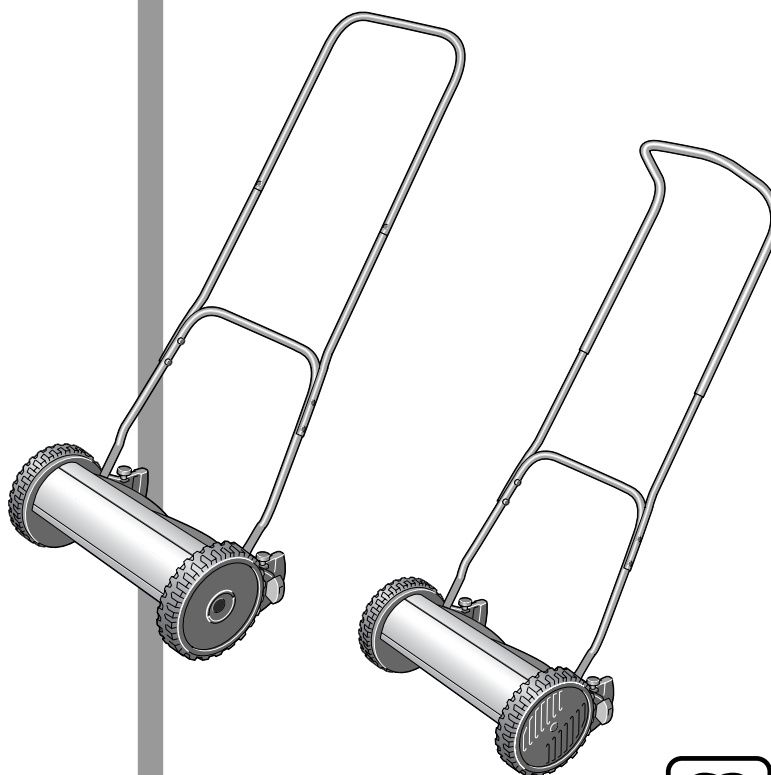

Deutsch
English
Français
Español
Português
Italiano
Nederlands
Dansk
Svenska
Norsk
Suomi
Ελληνικά
Türkçe



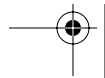
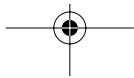
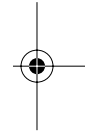
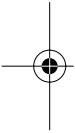
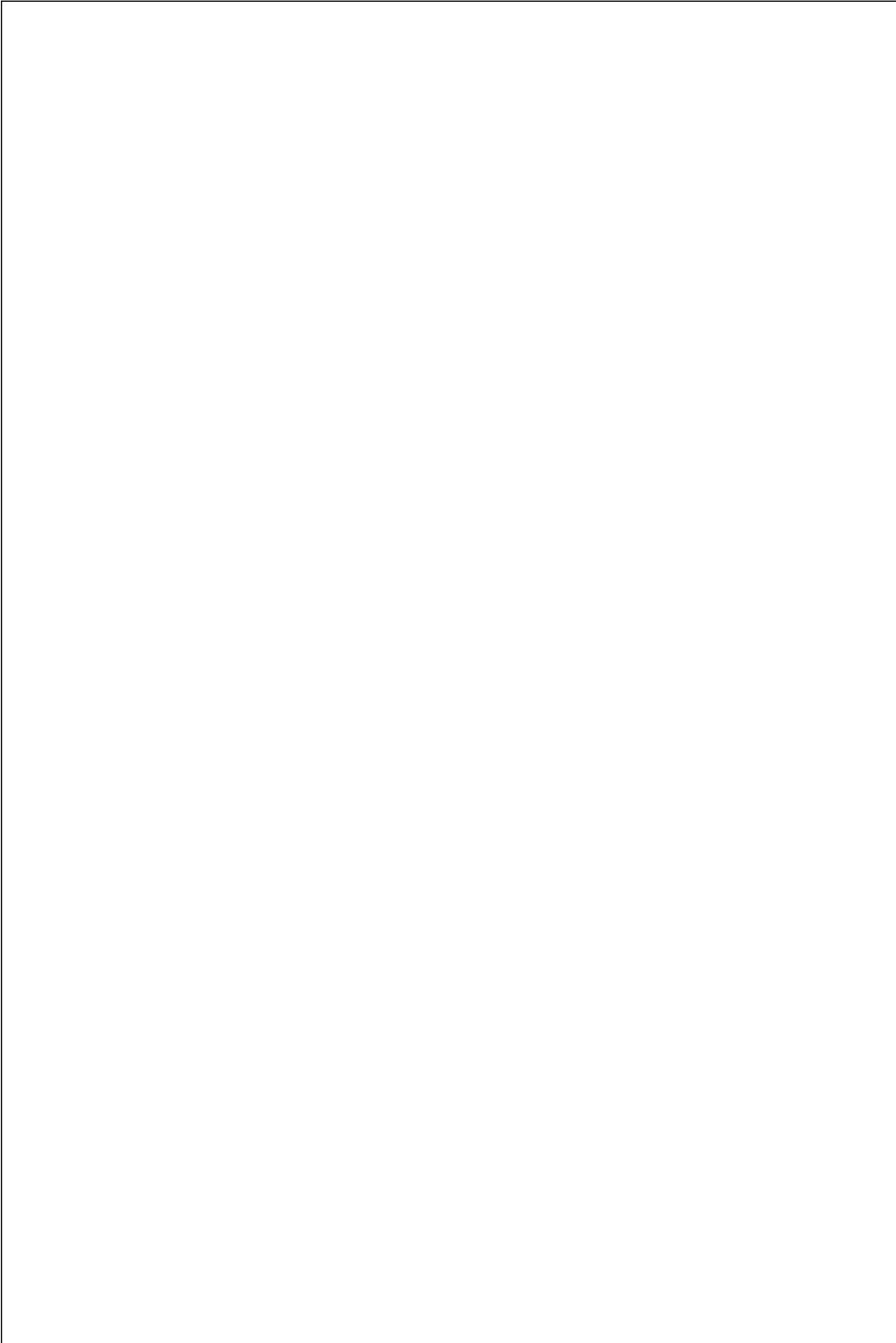
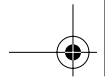

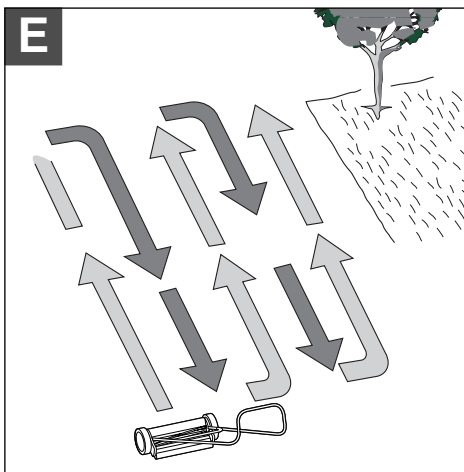
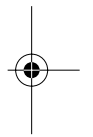
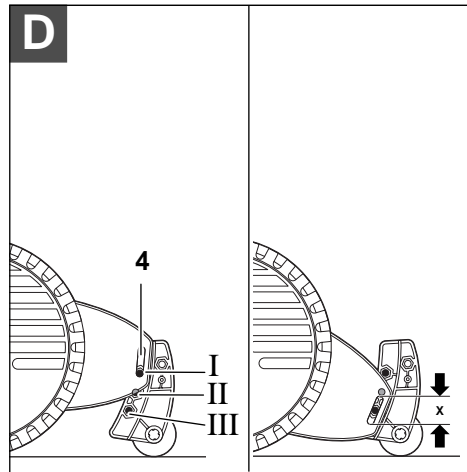
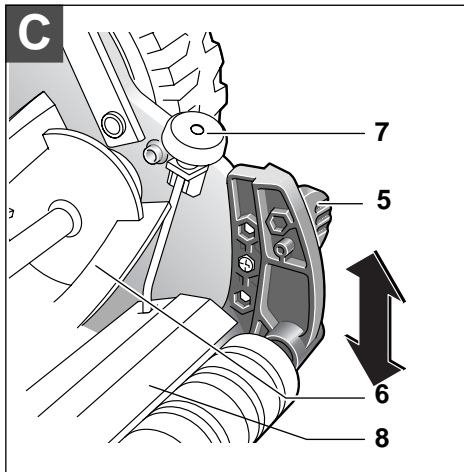
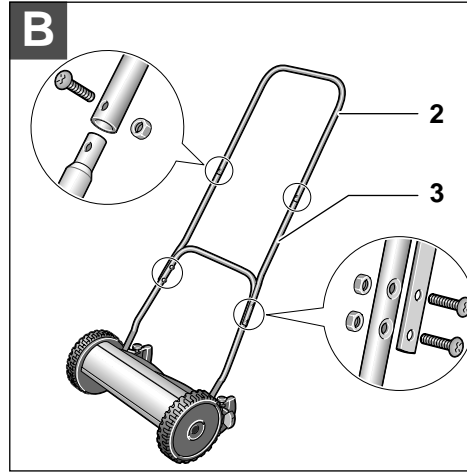
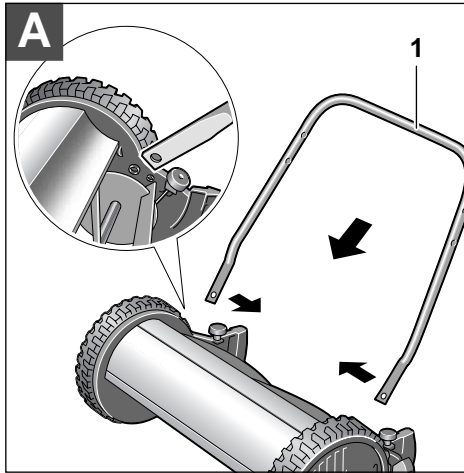



Sicherheitshinweise



Die nachfolgenden Anweisungen sorgfältig durchlesen.

Niemals mähen, während sich Personen, insbesondere Kinder oder Haustiere, in unmittelbarer Nähe aufhalten. Stets ruhig gehen, niemals schnell laufen.

Den Rasenmäher nicht barfuß oder mit offenen Sandalen benutzen.

Die zu mähende Fläche sorgfältig inspizieren und alle Fremdkörper beseitigen, welche von der Maschine weggeschleudert werden können.

Auf schrägen Flächen auf einen sicheren Tritt achten. Keine besonders steilen Abhänge mähen.

Den Festsitz aller Muttern, Bolzen und Schrauben sicherstellen, um zu gewährleisten, dass sich der Rasenmäher immer in einem sicheren Arbeitszustand befindet.

Sicherheitshalber abgenutzte oder beschädigte Teile auswechseln.

Beim Einstellen des Gerätes vermeiden, dass Füße oder Hände zwischen den beweglichen Messern und den feststehenden Teilen des Gerätes festgeklemmt werden.

Gerätekenne

Spindelmäher	AHM 30	AHM 38	AHM 30C	AHM 38C
Bestellnummer	0 600 886 001	0 600 886 101	0 600 886 002	0 600 886 102
Messerbreite	30 cm	38 cm	30 cm	38 cm
Anzahl der Messer	4	4	5	5
Schnitthöhe	12–40 mm	12–40 mm	15–43 mm	15–43 mm
Gewicht	5,6 kg	7,3 kg	5,8 kg	7,5 kg

Bestimmungsgemäßer Gebrauch

Dieses Produkt ist bestimmt für das Rasenmähen im privaten Bereich.

Einleitung

Dieses Handbuch enthält Anweisungen über die richtige Montage und den sicheren Gebrauch Ihrer Maschine. Es ist wichtig, dass Sie diese Anweisungen sorgfältig lesen.

Die Maschine wiegt im vollständig zusammengebauten Zustand etwa 5,6 kg - 7,5 kg. Holen Sie bei Bedarf Hilfe, um die Maschine aus der Verpackung zu nehmen.

Achten Sie auf die scharfen Messer, wenn Sie den Rasenmäher zum Rasen tragen.

Lieferumfang

Nehmen Sie den Rasenmäher vorsichtig aus der Verpackung prüfen Sie, ob die nachfolgenden Teile vollständig sind:

- Rasenmäher
- Griffunterteil
- Griffoberteil
- 2 Mittelstücken
- 6 Muttern
- 6 Schrauben
- Bedienungsanleitung

Wenn Teile fehlen oder beschädigt sind, wenden Sie sich bitte an Ihren Händler.

Montage

- A** Griffunterteil **1** am Mäher befestigen.
- B** Griffoberteil **2** an den Mittelstücken **3** und dann auf dem Griffunterteil befestigen.



C Schnitthöhe einstellen

D Grobeinstellung:

Die Führungen **4** in einer der drei Positionen befestigen: **I** große Höhe für unebenen Rasen, **II** mittlere Höhe für normalen Rasen und **III** niedrige Höhe für ebenen Rasen. Es genügt, die Positionen ein einziges Mal einzustellen. Die Feineinstellung kann sowohl bei langen oder kurzen Gras verwendet werden.

Höhe wie folgt ändern:

1. Die Flügelmuttern **5** und die Schrauben entfernen.
2. Die Schrauben entsprechend der Schnitthöhe auf die gewünschte Höhe versetzen.
3. Flügelmuttern **5** wieder befestigen.

D Feineinstellung (X):

Die Flügelmuttern **5** auf beiden Seiten des Mähers lösen. Verschieben Sie beide Führungen **4** gleichmäßig auf die gewünschte Schnitthöhe.

E Mähen

Optimale Mähergebnisse werden erzielt, wenn Sie vom Rand des Rasens ausgehend mit dem Mähen beginnen und vorwärts laufen. Am Ende der Bahn umkehren und die vorhergehende Bahn leicht überlappen.

Wartung

Hinweis: Führen Sie die folgenden Wartungsarbeiten regelmäßig aus, damit eine lange und zuverlässige Nutzung gewährleistet ist.

Den Rasenmäher regelmäßig auf offensichtliche Mängel wie lose oder beschädigte Messer, lose Verbindungen und abgenutzte oder beschädigte Teile untersuchen.

Prüfen Sie, ob Abdeckungen und Schutzvorrichtungen unbeschädigt und richtig angebracht sind. Führen Sie vor der Benutzung eventuell notwendige Wartungs- oder Reparaturarbeiten durch.

Sollte der Rasenmäher trotz sorgfältiger Herstellungs- und Prüfverfahren einmal ausfallen, ist die Reparatur von einer autorisierten Kundendienststelle für Bosch-Elektrowerkzeuge ausführen zu lassen.

Bei allen Rückfragen und Ersatzteilbestellungen bitte unbedingt die 10-stellige Bestellnummer laut Typenschild des Gerätes angeben.

Einstellung der Messer

Die Spindelmesser müssen neu nachgestellt werden, wenn das Gras nicht mehr sauber und gleichmäßig geschnitten wird.

Beide Einstellknöpfe **7** in kleinen Schritten im Uhrzeigersinn drehen, bis die Spindelmesser **6** leicht über das untere Messer **8** streifen.

Hinweis: Die Messer funktionieren wie eine Schere.

Zubehör

Grasfangkorb AHM 30/38C0 600 886 060

Grasfangkorb AHM 30/38C0 600 886 160

Nach dem Mähen/Aufbewahrung

Das Äußere des Rasenmähers gründlich mit einer weichen Bürste und einem Tuch reinigen. Kein Wasser und keine Lösungs- oder Poliermittel verwenden. Sämtliche Grasanhaftungen und Partikel entfernen.

Den Rasenmäher auf die Seite legen und den Messerbereich reinigen. Zusammengepresste Schnittgut mit einem Holz- oder Plastikstück entfernen.

Den Rasenmäher an einem trockenen Ort aufbewahren. Keine anderen Gegenstände auf die Maschine stellen.

Garantie

Für Bosch-Geräte leisten wir Garantie gemäß den gesetzlichen/länderspezifischen Bestimmungen (Nachweis durch Rechnung oder Lieferschein).

Schäden, die auf natürliche Abnutzung, Überlastung oder unsachgemäße Behandlung zurückzuführen sind, bleiben von der Garantie ausgeschlossen.

Beanstandungen können nur anerkannt werden, wenn Sie das Gerät **unzerlegt** an den Lieferer oder an eine Bosch-Kundendienstwerkstätte für Druckluft- oder Elektrowerkzeuge senden.





Umweltschutz



Bei der Herstellung der Maschine wurden ökologisch unbedenkliche Verfahren angewendet.

Rohstoffrückgewinnung statt Müllentsorgung

Maschine, Zubehörteile und Verpackung sollten für ein umweltfreundliches Recycling sortiert werden.

Diese Anleitung ist aus chlorfrei gefertigtem Recycling-Papier hergestellt.

Zum sortenreinen Recycling sind Kunststoffteile gekennzeichnet.

In Deutschland sind nicht mehr gebrauchsfähige Geräte/Akkus zum Recycling beim Handel abzugeben oder (ausreichend frankiert) direkt einzuschicken an:

Recyclingzentrum Elektrowerkzeuge
Osteroder Landstraße 3
37589 Kalefeld

Kundendienst

Deutschland

Robert Bosch GmbH
Servicezentrum Elektrowerkzeuge
Zur Luhne 2
D-37589 Kalefeld

☎ Service:..... 01 80 - 3 35 54 99

Fax +49 (0) 55 53 / 20 22 37

☎ Kundenberater: 01 80 - 3 33 57 99

Österreich

ABE Service GmbH
Jochen-Rindt-Straße 1
A-1232 Wien

☎ Service:..... +43 (0)1 / 61 03 80

Fax +43 (0)1 / 61 03 84 91

☎ Kundenberater:..... +43 (0)1 / 797 22 3066

E-Mail: abe@abe-service.co.at

Schweiz

Robert Bosch AG
Kundendienst Elektrowerkzeuge
Industriestrasse 31
CH-8112 Otelfingen

☎ Service:..... +41 (0)1 / 8 47 16 16

☎ Kundenberater:..... Grüne Nr. 0 800 55 11 55

Änderungen vorbehalten

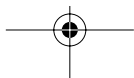
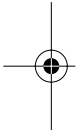



Safety Notes



Read the instructions carefully.

Never mow while people, especially children or pets, are nearby. Walk, never run.

Do not operate the mower when barefoot or wearing open sandals.

Thoroughly inspect the area where the appliance is to be used and remove all objects, which may be thrown by the machine.

Always be sure of your footing on slopes. Do not mow excessively steep slopes.

Keep all nuts, bolts and screws tight to be sure that the lawnmower is in safe working condition.

Replace worn or damaged parts for safety.

Be careful during adjustment of the machine to prevent entrapment of the fingers between moving blades and fixed parts of the machine.

Product Specification

Cylinder Mower	AHM 30	AHM 38	AHM 30C	AHM 38C
Part number	0 600 886 001	0 600 886 101	0 600 886 002	0 600 886 102
Blade width	30 cm	38 cm	30 cm	38 cm
No of Cylinder Blades	4	4	5	5
Height of cut	12 – 40 mm	12 – 40 mm	15 – 43 mm	15 – 43 mm
Weight	5.6 kg	7.3 kg	5.8 kg	7.5 kg

Intended Use

This product is intended for domestic lawn mowing.

Introduction

This manual gives instructions on the correct assembly and safe use of your machine. It is important that you read these instructions carefully.

When fully assembled the machine weighs approximately 5.6 kg - 7.5 kg. If necessary, obtain assistance to remove from packaging.

Take care when carrying the mower to the lawn, as the blades are sharp.

Delivered Items

Carefully remove the machine from its packaging and check that you have all the following items:

- Lawnmower
- Bottom handle
- Top handle
- 2 Handle Centres
- 6 Nuts
- 6 Bolts
- Operating instructions

When parts are missing or damaged, please contact your dealer.

Assembly

- A** Attach bottom handle **1** to the mower.
- B** Assemble the top handle **2** to the handle centres **3**, and fit to handle bottom **1**.

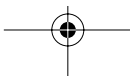
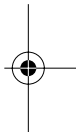
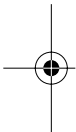



G Adjusting the Cutting Height

D Coarse:

The roller brackets **4** should be set in one of three positions according to the type of lawn: **I** for high range for bumpy lawns, **II** for medium range for average lawns and **III** for low range for reasonably flat lawns. You should only need to make this adjustment once, thereafter use the „Fine“ adjustment to cut longer or shorter grass.

To change the height of cut:

1. Remove the wingnut **5** and bolt.
2. Reposition the bolt for required height of cut.
3. Refit wingnut **5**.

D Fine (X):

Slacken wing nut **5** on both sides of the mower. Move both roller brackets **4** equally to the required height of cut.

E Mowing

For best results, place the lawnmower on the edge of lawn, mow in a forwards direction. Reverse at the end of the each turn, slightly overlapping the previous cut strip.

Maintenance

Note: To ensure long and reliable service, carry out the following maintenance regularly.

Regularly check for obvious defects such as loose, dislodged or damaged blades, loose fixings, and worn or damaged components.

Check that covers and guards are undamaged and correctly fitted. Carry out necessary maintenance or repairs before using.

If the mower should happen to fail despite the care taken in manufacture and testing, repair should be carried out by an authorised customer service agent for Bosch garden products.

For all correspondence and spare parts orders, always include the 10-digit part number from the nameplate of the machine!

Adjusting the Blade

The cutting cylinder should be adjusted if the grass is not cut cleanly and evenly.

Turn both adjuster knobs **7** clockwise a little at time until the cutting cylinder **6** lightly brushes the bottom blade **8**.

Note: The blades act like a pair of shears.

Accessories

Grassbox	AHM 30/38C	0 600 886 060
Grassbox	AHM 30/38C	0 600 886 160

After Mowing/Storage

Clean the exterior of the machine thoroughly using a soft brush and cloth. Do not use water, solvents or polishes. Remove all grass and debris.

Turn the machine on its side and clean the blade area. If grass cuttings are compacted in the blade area, remove with a wooden or plastic implement.

Store the lawnmower in a dry place. Do not place other objects on top of the machine.

Guarantee

We guarantee Bosch appliances in accordance with statutory/country-specific regulations (proof of purchase by invoice or delivery note).

Damage attributable to normal wear and tear, overload or improper handling will be excluded from the guarantee.

In case of complaint please send the machine, **undismantled**, to your dealer or the Bosch Service Centre for lawn and garden products.

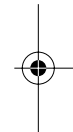



Environmental Protection



The machine has been assembled in an environmentally responsible way.

Recycle raw materials instead of disposing as waste.

Machine, accessories and packaging should be sorted for environment-friendly recycling.

These instructions are printed on recycled paper manufactured without chlorine.

The plastic components are labelled for categorized recycling.

When the time comes to dispose of this product, please consider the environment and take it to a recognized recycling facility (please contact your local authority for location information).

Service

Great Britain

Robert Bosch Ltd. (B.S.C.)
 P.O. Box 98
 Broadwater Park
 North Orbital Road
 Denham-Uxbridge
 GB-Middlesex UB 9 5HJ

☎ Service +44 (0) 18 95 / 83 87 82
 ☎ Advice line +44 (0) 18 95 / 83 87 91
 Fax +44 (0) 18 95 / 83 87 89

Ireland

Beaver Distribution Ltd.
 Greenhills Road
 IRL-Tallaght-Dublin 24

☎ Service +353 (0)1 / 414 9400
 Fax +353 (0)1 / 459 8030

Australia

Robert Bosch Australia L.t.d.
 RBAU/SPT2
 1555 Centre Road
 P.O. Box 66 Clayton
 AUS-3168 Clayton/Victoria

☎ +61 (0)1 / 800 804 777
 Fax +61 (0)1 / 800 819 520
 www.bosch.com.au
 E-Mail: CustomerSupportSPT@au.bosch.com

New Zealand

Robert Bosch Limited
 14-16 Constellation Drive
 Mairangi Bay
 Auckland
 New Zealand

☎ +64 (0)9 / 47 86 158
 Fax +64 (0)9 / 47 82 914

Subject to change without notice

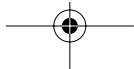
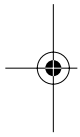



Instructions de sécurité



Lire attentivement les instructions suivantes.

Ne jamais tondre la pelouse lorsque des personnes, en particulier des enfants, ou des animaux domestiques se trouvent à proximité. Toujours marcher normalement, ne jamais courir.

Ne jamais faire fonctionner la tondeuse si on est pieds nus ou en sandalettes.

Inspecter soigneusement la surface à tondre et éliminer tout objet susceptible d'être happé et projeté par l'appareil.

Sur des pentes, faire attention à garder une position stable. Ne pas utiliser la tondeuse sur des pentes très abruptes.

Vérifier que les écrous, boulons et vis soient bien serrés afin que la tondeuse fonctionne sans danger.

Pour des raisons de sécurité, remplacer les pièces usées ou endommagées.

Lors du réglage de l'appareil, veiller à ne pas coincer les pieds ni les mains entre les lames en rotation ni dans les parties fixes de l'appareil.

Caractéristiques techniques

Tondeuse à cylindre	AHM 30	AHM 38	AHM 30C	AHM 38C
Référence	0 600 886 001	0 600 886 101	0 600 886 002	0 600 886 102
Largeur de la lame	30 cm	38 cm	30 cm	38 cm
Nombre de lames de coupe	4	4	5	5
Hauteur de coupe	12–40 mm	12–40 mm	15–43 mm	15–43 mm
Poids	5,6 kg	7,3 kg	5,8 kg	7,5 kg

Utilisation conforme

Ce produit est destiné à la tonte de pelouses de particuliers.

Introduction

Ce manuel contient des indications quant à la manière de monter et d'utiliser correctement la tondeuse. Il est important de lire attentivement ces instructions.

Une fois complètement assemblée, la machine pèse environ 5,6 kg - 7,5 kg. Si besoin est, vous faire aider pour retirer la machine de son emballage.

Faire attention aux lames coupantes en transportant la tondeuse sur le lieu de travail.

Pièces jointes à la machine

Retirer avec précaution la tondeuse de l'emballage et vérifier si tous les éléments suivants sont complets :

- Tondeuse
- Partie inférieure du guidon
- Partie supérieure du guidon
- 2 Pièces intermédiaires
- 6 Ecrous
- 6 Vis
- Instructions d'utilisation

S'il vous manque des éléments ou si l'un d'eux est endommagé, veuillez contacter votre revendeur.

Montage

A Fixer la partie inférieure du guidon **1** sur la tondeuse.

B Fixer la partie supérieure du guidon **2** sur les pièces intermédiaires **3** et puis sur la partie inférieure du guidon.



G Réglage de la hauteur de coupe

D Réglage approximatif :

Fixer les guidages **4** dans l'une des trois positions :
I hauteur de coupe élevée pour terrain irrégulier,
II hauteur de coupe moyenne pour pelouse moyenne et **III** petite hauteur de coupe pour pelouse assez rase. Il suffit de régler les positions une seule fois. Il est possible d'utiliser le réglage précis aussi bien pour de l'herbe longue que pour de l'herbe courte.

Modifier la hauteur de la manière suivante :

1. Enlever les écrous papillon **5** et les vis.
2. Déplacer les vis conformément à la hauteur de coupe souhaitée.
3. Resserrer les écrous papillon **5**.

D Réglage précis (X) :

Desserrer les écrous papillon **5** des deux côtés de la tondeuse. Déplacer les deux guidages **4** de manière égale sur la hauteur de coupe souhaitée.

E Tondre

Vous obtiendrez les meilleurs résultats de tonte en commençant les travaux en bordure du gazon et en suivant. Une fois arrivé au bout, retourner en chevauchant légèrement la passe précédente.

Nettoyage

Remarque : afin d'assurer une utilisation longue et fiable de la tondeuse, procéder à intervalles réguliers aux travaux d'entretien suivants.

Vérifier régulièrement qu'il n'y ait pas de défauts tels que des lames desserrées ou endommagées, des raccords détachés ou encore des pièces usées ou abîmées.

Vérifier que les couvercles et les dispositifs de protection ne soient pas endommagés et qu'ils soient correctement branchés. Avant d'utiliser la machine, effectuer les travaux d'entretien et de réparation éventuellement nécessaires.

Si, malgré tous les soins apportés à la fabrication et au contrôle de la tondeuse, celle-ci devait avoir un défaut, la réparation ne doit être confiée qu'à une station de service après-vente agréée pour outillage Bosch.

Pour toute demande de renseignements ou commande de pièces de rechange, nous préciser impérativement le numéro de référence à dix chiffres de la machine.

Réglage des lames de coupe

Le cylindre de coupe doit être rajusté lorsque l'herbe n'est pas coupée nettement et de manière régulière.

Tourner les deux boutons de réglage **7** par petites étapes et dans le sens des aiguilles d'une montre jusqu'à ce que le cylindre de coupe **6** frôle à peine la lame inférieure **8**.

Remarque : Les lames fonctionnent comme des ciseaux.

Accessoires

Bac de ramassage AHM 30/38C 0 600 886 060

Bac de ramassage AHM 30/38C..... 0 600 886 160

Après la tonte/l'entreposage de la tondeuse

Nettoyer soigneusement les parties extérieures de la tondeuse à l'aide d'une brosse douce ou d'un torchon. Ne pas utiliser d'eau ni de solvants ou détergents abrasifs. Enlever toutes les herbes et particules pouvant adhérer sur l'appareil.

Poser la tondeuse sur le côté et nettoyer la zone des lames. Enlever les herbes coincées à l'aide d'un morceau de bois ou de plastique.

Ranger la tondeuse dans un endroit sec. Ne pas poser d'autres objets sur la machine.

Garantie

Les appareils Bosch sont garantis conformément aux dispositions légales/nationales (contre preuve d'achat, facture ou bordereau de livraison). Cette garantie implique le remplacement gratuit des pièces défectueuses. En tout état de cause s'applique la garantie légale couvrant toutes les conséquences des défauts ou vices cachés (Articles 1641 et suivants du Code civil.)

Cette garantie correspond à un emploi normal de l'outil et exclut les avaries dues à un mauvais usage, à un entretien défectueux ou à l'usure normale. Le jeu de la garantie ne peut en aucun cas donner lieu à des dommages et intérêts.

Pour que cette garantie soit valable, il y a lieu de retourner l'outil **non démonté** au vendeur ou à une station de service après-vente Bosch, accompagné de la preuve d'achat mentionnant la date d'acquisition, le nom de l'utilisateur et le nom du revendeur.





Protection de l'environnement



Cette machine a été fabriquée d'une manière respectueuse de l'environnement.

Récupération des matières premières plutôt qu'élimination des déchets

La machine, les accessoires et l'emballage doivent être triés pour un recyclage protégeant l'environnement.

Ce manuel d'instructions a été fabriqué à partir d'un papier recyclé blanchi en l'absence de chlore.

Nos pièces plastiques ont ainsi été marquées en vue d'un recyclage sélectif des différents matériaux.

Service après-vente

France

Information par Minitel 11

Nom : Bosch Outillage

Loc : Saint Ouen

Dépt : 93

Robert Bosch France S.A.

Service Après-vente/Outillage

B.P. 67-50, Rue Ardoin

F-93402 St. Ouen Cedex

☎ Service conseil client,

Numéro Vert..... 0 800 05 50 51

Belgique

Robert Bosch S.A.

After Sales Service Outillage

Rue Henri Genesse 1

BE-1070 Bruxelles

☎ +32 (0)2 / 525.50.29

Fax +32 (0)2 / 525.54.30

☎ Service conseil client +32 (0)2 / 525.53.07

E-Mail : Outillage.Gereedschappen@be.bosch.com

Suisse

Robert Bosch AG

Service après-vente/Outillage

Industriestrasse 31

CH-8112 Otelfingen

☎ +41 (0)1 / 8 47 16 16

☎ Service conseil client,

Numéro Vert..... 0 800 55 11 55

Sous réserve de modifications



Instrucciones de seguridad



Lea con detenimiento las instrucciones siguientes.

Jamás corte el césped si se encuentran personas, especialmente niños, o animales domésticos, en las inmediaciones del aparato. Camine de forma pausada y nunca de forma apresurada.

No emplee el cortacésped si va descalzo o lleva sandalias.

Inspeccione minuciosamente el área a trabajar, y eliminar todo cuerpo extraño que pudiera salir impulsado por la máquina.

Al trabajar áreas en pendiente, preste especial atención en mantener una posición firme. No corte el césped en áreas con una pendiente muy pronunciada.

Asegurarse que todas las tuercas, pernos y tornillos estén firmemente apretados para que el cortacésped se encuentre siempre en un estado de trabajo seguro.

Como medida de seguridad, dejar sustituir las partes desgastadas o dañadas.

Al ajustar el aparato prestar atención a que las cuchillas no le aprisionen los pies ni las manos contra las partes fijas del aparato.

Características técnicas

Cortacésped de husillo	AHM 30	AHM 38	AHM 30C	AHM 38C
Número de pedido	0 600 886 001	0 600 886 101	0 600 886 002	0 600 886 102
Anchura de la cuchilla	30 cm	38 cm	30 cm	38 cm
Número de cuchillas	4	4	5	5
Altura de corte	12–40 mm	12–40 mm	15–43 mm	15–43 mm
Peso	5,6 kg	7,3 kg	5,8 kg	7,5 kg

Utilización reglamentaria

Este producto ha sido proyectado para utilizarse en el área doméstica.

Introducción

Este manual incluye instrucciones sobre el montaje correcto y la utilización segura de la máquina. Es muy importante leer minuciosamente estas instrucciones.

La máquina montada íntegramente pesa unos 5,6 kg - 7,5 kg. Si fuese necesario, recurra a otra persona para sacar la máquina del embalaje.

Tenga cuidado con la cuchilla al transportar el cortacésped.

Material que se adjunta

Extraiga con cuidado el cortacésped del embalaje y verifique si las partes citadas a continuación están completas:

- Cortacésped
- Parte inferior de la empuñadura
- Parte superior de la empuñadura
- 2 Piezas intermedias
- 6 Tuercas
- 6 Tornillos
- Instrucciones de manejo

Si faltasen piezas, o si alguna de ellas estuviese dañada, diríjase por favor al comercio de su adquisición.

Montaje

A Fijar al cortacésped la parte inferior de la empuñadura **1**.

B Unir la parte superior de la empuñadura **2** con las piezas intermedias **3** y fijarlas a continuación a la parte inferior de la empuñadura.



C Ajuste de la altura de corte

D Ajuste aproximado:

Sujetar las guías **4** en una de las tres posiciones: **I** altura grande para césped de altura irregular, **II** altura mediana para césped normal y **III** altura reducida para césped de altura uniforme. Es suficiente ajustar las posiciones una sola vez. El ajuste fino puede emplearse indistintamente para césped alto y bajo.

Modificar la altura de la manera siguiente:

1. Desmontar las tuercas de mariposa **5** y los tornillos.
2. Variar la posición de los tornillos de acuerdo a la altura de corte deseada.
3. Volver a montar las tuercas **5**.

D Ajuste fino (X):

Aflojar las tuercas de mariposa **5** a ambos lados del cortacésped. Desplazar por igual ambas guías **4** hasta obtener la altura de corte deseada.

E Corte del césped

El césped se corta de forma óptima si se comienza a cortar desde el borde guiando hacia adelante el cortacésped. Al alcanzar el borde al otro extremo, debe darse la vuelta para continuar cortando en sentido contrario cuidando de mantener un ligero solape con la franja cortada anteriormente.

Mantenimiento

Observación: efectúe periódicamente los siguientes trabajos de mantenimiento para asegurar una utilización prolongada y fiable del aparato.

Inspeccionar periódicamente el cortacésped para ver si la cuchilla esta suelta o dañada, si existen uniones flojas, o piezas desgastadas o dañadas.

Verifique que las cubiertas y dispositivos protectores estén correctamente montados y que no estén dañados. Antes de la utilización del aparato efectúe los trabajos de mantenimiento o reparación que sean necesarios.

Si a pesar de los esmerados procesos de fabricación y control, la cortadora de césped llegase a averiarse, la reparación deberá encargarse a un taller de servicio autorizado para herramientas eléctricas Bosch.

Al realizar consultas o solicitar piezas de repuesto, ¡es imprescindible indicar siempre el número de pedido de 10 cifras que figura en la placa de características del aparato!

Ajuste de las cuchillas

Las cuchillas del husillo deben reajustarse siempre que el corte del césped no sea limpio, o al ser irregular.

Ir girando poco a poco ambos botones de ajuste **7** en el sentido de las agujas del reloj hasta que las cuchillas del husillo **6** alcancen a rozar levemente contra la cuchilla inferior **8**.

Observación: el funcionamiento de las cuchillas es similar a una tijera.

Accesorios

Cesto colector de césped

AHM 30/38C.....0 600 886 060

Cesto colector de césped

AHM 30/38C.....0 600 886 160

Después del corte/almacenaje

Limpiar a fondo el exterior del cortacésped con un cepillo blando y un paño. No utilizar agua ni disolventes, ni agentes pulidores. Desprender completamente los restos de césped y partículas que pudieran estar adheridas.

Colocar el cortacésped sobre un costado y limpiar el área de las cuchillas. Desprender el material compactado que pudiera estar adherido, con un trozo de madera o plástico.

Guardar el cortacésped en un lugar seco. No depositar otros objetos sobre la máquina.

Garantía

Para los aparatos Bosch concedemos una garantía de acuerdo con las prescripciones legales específicas de cada país (comprobación a través de la factura o albarán de entrega).

Quedan excluidos de garantía los daños ocasionados por desgaste natural, sobrecarga o manejo inadecuado.

Las reclamaciones únicamente pueden considerarse si la máquina se envía **sin desmontar** al suministrador de la misma o a un servicio técnico Bosch de herramientas neumáticas o eléctricas.





Protección del medio ambiente



En la fabricación de la máquina se utilizaron procedimientos ecológicos.

Recuperación de materias primas en lugar de eliminación de desperdicios.

Para permitir un reciclaje ecológico es recomendable clasificar de forma selectiva los materiales de la máquina, accesorios y del embalaje.

Estas instrucciones se han impreso sobre papel reciclado sin la utilización de cloro.

Para efectuar un reciclaje selectivo se han marcado las piezas de material plástico.

Servicio de asistencia técnica

España

Robert Bosch España, S.A.
Departamento de ventas
Herramientas Eléctricas
C/Hermanos García Noblejas, 19
E-28037 Madrid

☎ Asesoramiento al cliente..... +34 901 11 66 97
Fax +34 91 327 98 63

Venezuela

Robert Bosch S.A.
Final Calle Vargas. Edf. Centro Berimer P.B.
Boleita Norte
Caracas 107

☎ +58 (0)2 / 207 45 11

Mexico

Robert Bosch S.A. de C.V.

☎ Interior:..... +52 (0)1 / 800 250 3648

☎ D.F.: +52 (0)1 / 5662 8785

E-Mail: arturo.fernandez@mx.bosch.com

Argentina

Robert Bosch Argentina S.A.
Córdoba 5160
1414 Buenos Aires (Capital Federal)
Atención al Cliente

☎ +54 (0)810 / 555 2020

E-Mail: herramientas.bosch@ar.bosch.com

Peru

Autorex Peruana S.A.
República de Panamá 4045,
Lima 34

☎ +51 (0)1 / 475-5453

E-Mail: vhe@autorex.com.pe

Chile

EMASA S.A.
Irrazaval 259 – Ñuñoa
Santiago

☎ +56 (0)2 / 520 3100

E-Mail: emasa@emasa.cl

Reservado el derecho de modificaciones

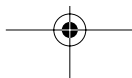
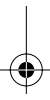
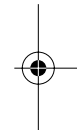



Instruções de segurança



Leia atentamente as seguintes instruções.

Jamais corte a relva enquanto pessoas, principalmente crianças ou animais domésticos, se encontrarem perto do local de trabalho. Sempre ande, jamais corra.

Não utilizar o corta relva quando estiver descalço ou usando sandalhas abertas.

A superfície da relva a ser cortada deve ser inspecionada cuidadosamente e devem ser eliminados todos os corpos estranhos que possam ser atirados para longe pela máquina.

Em superfícies inclinadas, deverá andar sempre com cuidado e com segurança. Jamais utilize o aparelho em declives demasiadamente íngremes.

Assegure-se de que todas as porcas, pinos e parafusos estejam fixos, para garantir que o corta relva esteja sempre em perfeito estado de funcionamento e possa trabalhar com segurança.

Por motivos de segurança, deverá substituir peças gastas ou danificadas.

Ao ajustar o aparelho, deverá evitar que pés ou mãos sejam entalados entre as lâminas móveis e as partes fixas do aparelho.

Dados técnicos do aparelho

Corta relva silencioso	AHM 30	AHM 38	AHM 30C	AHM 38C
Nº de encomenda	0 600 886 001	0 600 886 101	0 600 886 002	0 600 886 102
Largura da lâmina	30 cm	38 cm	30 cm	38 cm
Número das lâminas	4	4	5	5
Altura de corte	12–40 mm	12–40 mm	15–43 mm	15–43 mm
Peso	5,6 kg	7,3 kg	5,8 kg	7,5 kg

Utilização de acordo com as disposições

Este produto é concebido para o corte de relva doméstico.

Introdução

Este manual contém instruções sobre a montagem correcta e a utilização segura da sua máquina. É importante ler atentamente estas instruções.

A máquina totalmente montada pesa aprox. 5,6 kg - 7,5 kg. Se necessário, peça auxílio para retirar a máquina da embalagem.

Tome atenção com as lâminas afiadas ao transportar o corta relva para o local de trabalho.

Componentes fornecidos

Retire cuidadosamente o corta relva da embalagem e certifique-se que esta contém as seguintes peças:

- Corta relva
- Parte inferior do punho
- Parte superior do punho
- 2 Peças centrais
- 6 Porcas
- 6 Parafusos
- Instrução de serviço

Se quaisquer peças estiverem faltando ou danificadas, dirija-se ao seu revendedor autorizado.

Montagem

- A** Fixar a parte inferior do punho **1** ao corta relva.
- B** Fixar a parte superior do punho **2** às partes centrais **3** e em seguida à parte inferior do punho.



C Ajustar a altura de corte

D Ajuste aproximado:

Fixar os guias **4** numa das três posições: **I** grande altura para relvas desniveladas, **II** altura média para relva normal **III** altura pequena para relvas niveladas. É suficiente ajustar as posições uma única vez. O ajuste fino pode ser utilizado para relva longa como para relva curta.

Alterar a altura da seguinte forma:

1. Remover as porcas de orelha **5** e os parafusos.
2. Colocar os parafusos na altura desejada de acordo com a respectiva altura de corte.
3. Fixar novamente as porcas de orelha **5**.

D Ajuste fino (X):

Soltar a porca de orelha **5** em ambos os lados do corta-relvas. Deslocar simultaneamente os dois guias **4** para a altura de corte desejada.

E Cortar relva

Resultados ideais de corte da relva são alcançados, se começar a cortar a relva a partir do canto da relva e andando para frente. No final da pista deverá retornar e sobrepassar um pouco a pista anterior.

Manutenção

Indicação: As seguintes tarefas de manutenção devem ser realizadas regularmente, para que seja assegurada uma longa vida útil do aparelho e um funcionamento fiável.

Controlar o corta relva regularmente para verificar se apresenta insuficiências óbvias, como por exemplo lâminas soltas ou danificadas, ligações soltas e peças gastas ou danificadas.

Verifique se as tampas e os dispositivos de protecção estão em perfeito estado e correctamente montados. Proceda à manutenção ou reparações necessárias antes de utilizar o corta relva.

Caso o corta relva venha a apresentar falhas, apesar de cuidadosos processos de fabricação e de controlo de qualidade, deve ser reparado em um serviço técnico autorizado para ferramentas eléctricas Bosch.

No caso de informações e encomendas de acessórios, indique por favor sem falta o número de encomenda de 10 algarismos do aparelho!

Ajuste das lâminas

As lâminas de veio devem ser reajustadas, logo que a relva não for cortada de forma correcta e uniforme.

Girar ambos os botões de ajuste **7** em pequenos passos no sentido dos ponteiros do relógio, até que as lâminas do veio **6** deslizem levemente sobre a lâmina inferior **8**.

Indicação: As lâminas funcionam como uma tesoura.

Acessório

Cesto colector de relva
AHM 30/38C..... 0 600 886 060
Cesto colector de relva
AHM 30/38C..... 0 600 886 160

Após cortar a relva / arrecadação

Limpar as partes externas do corta relvas cuidadosamente com uma escova macia e um pano. Não utilizar solventes ou líquidos de polimento. Remover todas as aderências de resíduos de relva e outras partículas.

Vire o corta relva para o lado e limpe a zona da lâmina. Utilize um utensílio de madeira ou de plástico para retirar material de relva cortada que esteja preso nesta área.

Guardar o corta relvas em local seco. Não colocar outros objectos sobre a máquina.

Garantia

Prestamos garantia para aparelhos Bosch de acordo com as disposições legais/específicas do país (comprovação através da factura ou da guia de remessa).

Avarias provenientes de desgaste natural, sobrecarga ou má utilização não são abrangidas pela garantia.

Em caso de reclamação enviar o aparelho, **sem ser desmontado**, ao fornecedor ou a um serviço de assistência técnica autorizado Bosch Ferramentas Electricas.





Protecção do meio-ambiente



Para a fabricação desta máquina, foram aplicados processos ecologicamente inofensivos.

Reciclagem de matérias primas em vez de eliminação de lixo.

A máquina, os acessórios e a embalagem deveria ser reciclados separadamente.

Estas instruções foram manufacturadas com papel reciclável isento de cloro.

Para efeitos de uma reciclagem específica, as peças de plástico dispõem de uma respectiva marcação.

Serviço ao cliente

Portugal

Robert Bosch LDA
Avenida Infante D. Henrique
Lotes 2E-3E
P-1800 Lisboa

☎ +351 21 / 8 50 00 00
Fax +351 21 / 8 51 10 96

Brasil

Robert Bosch Ltda.
Caixa postal 1195
13065-900 Campinas

☎ 0800 / 70 45446

E-Mail: sac@bosch-sac.com.br

Reservado o direito a modificações

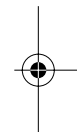
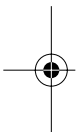



Istruzioni per la sicurezza



Leggere attentamente le istruzioni che seguono.

Non utilizzare mai il tosaerba nelle vicinanze d'altre persone, soprattutto bambini, o di animali domestici. Camminare e non correre mai.

Non utilizzare il tosaerba a piedi nudi o calzando sandali aperti.

Ispezionare accuratamente la superficie che si intende tosare ed avere cura di rimuovervi ogni corpo estraneo che la macchina potrebbe scaraventare per aria.

In caso di superfici pendenti, assicurarsi sempre un'andatura sicura. Non tosare l'erba su pendenze eccessivamente ripide.

Mantenere serrati tutti i dadi, i bulloni e le viti per essere certi che il tosaerba operi in condizioni di sicurezza.

A titolo di sicurezza, sostituire le parti usurate o danneggiate.

Durante l'operazione di regolazione della macchina, evitare assolutamente che piedi o mani possano restare bloccati tra le lame mobili oppure tra le parti fisse della macchina.

Dati tecnici

Tosaerba silenzioso	AHM 30	AHM 38	AHM 30C	AHM 38C
Codice di ordinazione	0 600 886 001	0 600 886 101	0 600 886 002	0 600 886 102
Larghezza lame	30 cm	38 cm	30 cm	38 cm
Quantità delle lame da taglio	4	4	5	5
Altezza di taglio	12–40 mm	12–40 mm	15–43 mm	15–43 mm
Peso	5,6 kg	7,3 kg	5,8 kg	7,5 kg

Uso conforme alle norme

Questo prodotto è stato concepito per tosare l'erba di prati domestici.

Introduzione

Il presente manuale fornisce le istruzioni per un corretto assemblaggio ed un utilizzo sicuro del Vostro tosaerba. Leggere attentamente tali istruzioni.

Con il completo imballo, la macchina pesa circa 5,6 kg - 7,5 kg. Se il caso, farsi aiutare per estrarre la macchina dall'imballaggio.

Quando si trasporta il tosaerba verso il luogo d'impiego, attenzione a non toccare le lame taglienti.

Volume di fornitura

Estrarre con cautela la macchina dall'imballaggio e verificare la presenza dei seguenti elementi:

- Tosaerba
- Parte inferiore dell'impugnatura
- Parte superiore dell'impugnatura
- 2 Elementi intermedi
- 6 Dadi
- 6 Viti
- Manuale di istruzioni

In caso che un qualsiasi elemento dovesse mancare oppure dovesse essere danneggiato, mettersi in contatto con il rivenditore presso il quale avete acquistato il tosaerba.

Montaggio

- Montare la parte inferiore dell'impugnatura **1** al tosaerba.
- Montare la parte superiore dell'impugnatura **2** agli elementi intermedi **3** e poi alla parte inferiore dell'impugnatura.

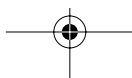



G Regolazione dell'altezza di taglio

D Regolazione approssimativa:

Fissare le guide **4** in una delle tre posizioni: **I** altezza maggiore per prato che non omogeneamente piano, **II** altezza media per prato normale e **III** altezza bassa per prato piano. Sarà sufficiente regolare una sola volta le posizioni. La regolazione di precisione può essere utilizzata sia in caso di erba alta che in caso di erba corta.

Modificare l'altezza procedendo come segue:

1. Rimuovere i dadi ad alette **5** e le viti.
2. Spostare le viti sull'altezza che si desidera rispettivamente all'altezza di taglio.
3. Avvitare di nuovo bene i dadi ad alette **5**.

D Regolazione di precisione (X):

Allentare i dadi ad alette **5** sui due lati del tosaerba. Spostare le due guide **4** in modo uniforme sull'altezza di taglio che si desidera.

E Tosatura dell'erba

Per raggiungere ottimali risultati di tosatura, iniziare l'operazione di tosatura partendo dal margine della superficie erbata e procedere in avanti fino. Alla fine della traiettoria di tosatura, girare e tosare in senso inverso sovrapponendo leggermente la traiettoria precedente.

Manutenzione

Nota: Per garantire un funzionamento durevole ed affidabile, eseguire regolarmente le seguenti operazioni di manutenzione.

Accertarsi periodicamente che il tosaerba non abbia difetti evidenti, quali lame allentate o danneggiate, fissaggi allentati e parti usurate o danneggiate.

Controllare che i coperchi e le protezioni non siano danneggiati e siano montati correttamente. Eseguire le necessarie operazioni di manutenzione e riparazione prima di usare la macchina.

Se nonostante gli accurati procedimenti di produzione e di controllo il tosaerba dovesse guastarsi, la riparazione va fatta effettuare da un Centro di assistenza Clienti autorizzato per gli elettrodomestici Bosch.

Comunicare sempre il codice di ordinazione a 10 cifre dell'elettrodomestico in caso di richieste o di ordinazione di pezzi di ricambio!

Regolazione delle lame da taglio

Se l'erba non è tagliata in modo netto e uniforme, occorre regolare il cilindro di taglio.

Ruotare entrambe le due manopole di regolazione **7** a piccoli passi in senso orario fino a quando le lame a vite **6** arriveranno a strisciare leggermente sulla lama da taglio inferiore **8**.

Le lame funzionano come un paio di cesoie.

Accessorio opzionale

Cestello raccogliherba AHM 30/38C...0 600 886 060

Cestello raccogliherba AHM 30/38C...0 600 886 160

Dopo la tosatura/Rimessaggio

Pulire a fondo la parte esterna della macchina con una spazzola morbida ed un panno. Non utilizzare né acqua, né solventi né lucidi. Rimuovere completamente ogni resto di erba tagliata e di detriti.

Girare la macchina su un lato e pulire l'area delle lame. Se in tale area sono presenti residui compatti di erba tagliata, rimuoverli con un utensile di legno o di plastica.

Conservare il tosaerba in un luogo asciutto. Non posare nessun altro oggetto sulla macchina.

Garanzia

Per gli apparecchi Bosch forniamo garanzia conforme alle disposizioni di legge/specifiche nazionali (certificazione a mezzo fattura o bolla di consegna).

Guasti derivanti da usura naturale, sovraccarico oppure uso improprio dell'apparecchio sono esclusi dalla garanzia.

La garanzia è subordinata alla compilazione completa di questo certificato.

Modello:

Data di acquisto:

Rivenditore (Timbro e firma):

Si accettano reclami solo se l'apparecchio viene inviato, **non smontato**, al fornitore oppure a una officina del Servizio Assistenza Clienti Bosch per utensili elettrici.





Misure ecologiche



Questo tosaerba è stato costruito tenendo in considerazione i fattori di tutela dell'ambiente.

Recupero di materie prime, piuttosto che smaltimento di rifiuti.

Ai fini di un riciclaggio ecologico, la macchina, le parti di ricambio ed il materiale d'imballaggio devono essere smaltiti separatamente.

Queste istruzioni sono stampate su carta riciclata sbiancata senza cloro.

I componenti in plastica sono contrassegnati per il riciclaggio selezionato.

Centro di Assistenza Clienti

Italia

Robert Bosch S.p.A.
Via Giovanni da Udine 15
I-20156 Milano

☎ +39 02 / 3 69 66 63

Fax +39 02 / 3 69 66 62

☎ Filo diretto con Bosch: +39 02 / 3 69 63 14

www.Bosch.it

Svizzera

Robert Bosch AG
Servizio Elettrotensili
Industriestrasse 31
CH-8112 Otelfingen

☎ Servizio +41 (0)1 / 8 47 16 16

☎ Consulente per la clientela:
Numero verde 0 800 55 11 55

Con riserva di modifiche

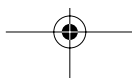
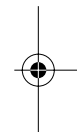
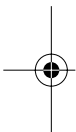



Veiligheidsvoorschriften



Lees de volgende voorschriften zorgvuldig.

Maai nooit dicht in de buurt van personen, in het bijzonder kinderen, of huisdieren. Loop altijd rustig, nooit te snel.

Gebruik de gazonmaaier niet op blote voeten of met sandalen.

Controleer het te maaien oppervlak zorgvuldig en verwijder alle voorwerpen die door de machine kunnen worden weggeslingerd.

Loop behoedzaam op een helling. Maai niet op bijzonder steile hellingen.

Controleer of alle moeren, bouten en schroeven vastzitten om er zeker van te zijn dat de gazonmaaier zich in een veilige gebruikstoestand bevindt.

Vervang versleten of beschadigde delen veiligheids-halve.

Voorkom bij het instellen van de machine dat voeten of handen tussen de bewegende messen en de vaste delen van de machine worden vastgeklemd.

Technische gegevens

Kooi-maaier	AHM 30	AHM 38	AHM 30C	AHM 38C
Bestelnummer	0 600 886 001	0 600 886 101	0 600 886 002	0 600 886 102
Mesbreedte	30 cm	38 cm	30 cm	38 cm
Aantal messen	4	4	5	5
Maaihogte	12–40 mm	12–40 mm	15–43 mm	15–43 mm
Gewicht	5,6 kg	7,3 kg	5,8 kg	7,5 kg

Gebruik volgens bestemming

Dit product is bestemd voor het maaien van gazons (uitsluitend particulier gebruik).

Inleiding

Dit handboek bevat voorschriften over de juiste montage en het veilig gebruik van uw machine. Het is belangrijk dat u deze voorschriften zorgvuldig leest.

De machine weegt in compleet gemonteerde toestand ongeveer 5,6 kg - 7,5 kg. Vraag indien nodig hulp om de machine uit de verpakking te nemen.

Let op de scherpe messen wanneer u de gazonmaaier naar het gazon draagt.

Meegeleverd

Neem de gazonmaaier voorzichtig uit de verpakking. Controleer of de volgende delen compleet zijn:

- Gazonmaaier
- Greeponderstuk
- Greepbovenstuk
- 2 Middenstukken
- 6 Moeren
- 6 Schroeven
- Gebruiksaanwijzing

Neem contact op met uw leverancier wanneer onderdelen ontbreken of beschadigd zijn.

Montage

- Bevestig het greeponderstuk **1** aan de maaier.
- Bevestig het greepbovenstuk **2** aan de middenstukken **3** en vervolgens aan het greeponderstuk.



G Maaihoogte instellen

D Grofinstelling:

Bevestig de geleidingen **4** in een van de drie standen: **I** grote hoogte voor ongelijkmatig gazon, **II** gemiddelde hoogte voor normaal gazon of **III** lage hoogte voor vlak gazon. Eenmalig instellen van de standen is voldoende. De fijninstelling kunt u zowel bij lang als bij kort gras gebruiken.

Verander de hoogte als volgt:

1. Verwijder de vleugelmoeren **5** en de schroeven.
2. Verplaats de schroeven volgens de maaihoogte op de gewenste stand.
3. Draai de vleugelmoeren **5** weer vast.

D Fijninstelling (X):

Draai de vleugelmoeren **5** aan beide zijden van de maaier los. Verschuif beide geleidingen **4** gelijkmatig op de gewenste maaihoogte.

E Maaien

U bereikt optimale maaieresultaten wanneer u vanaf de rand van het gazon met maaien begint en verder maait. Keer aan het einde van de baan om en overlap de voorafgaande baan licht.

Onderhoud

Opmerking: Voer de volgende onderhoudswerkzaamheden regelmatig uit zodat u verzekerd bent van een lang en probleemloos gebruik.

Controleer de gazonmaaier regelmatig op zichtbare gebreken zoals losse of beschadigde messen, losse verbindingen en versleten of beschadigde delen.

Controleer of afschermingen en veiligheidsvoorzieningen niet beschadigd zijn en juist zijn aangebracht. Voer voor het gebruik eventueel noodzakelijke onderhouds- of reparatiewerkzaamheden uit.

Wanneer de gazonmaaier ondanks zorgvuldige productie- en testprocedures toch defect raakt, moet de reparatie door een erkende klantenservice voor Bosch elektrische gereedschappen worden uitgevoerd.

Vermeld bij vragen en bestellingen van vervangingsonderdelen altijd het bestelnummer van 10 cijfers van de machine.

Instelling van de messen

De messen moeten worden bijgesteld wanneer het gras niet meer netjes en gelijkmatig wordt gemaaid.

Draai beide instelknoppen **7** in kleine stappen met de wijzers van de klok mee tot de spilmessen **6** licht over het onderste mes **8** strijken.

Opmerking: De messen werken als een schaar.

Toebehoren

Grasbak	AHM 30/38C	0 600 886 060
Grasbak	AHM 30/38C	0 600 886 160

Na het maaien. Machine opbergen

Maak de buitenkant van de gazonmaaier grondig schoon met een zachte borstel en een doek. Gebruik geen water en geen oplos- of polijstmiddelen. Verwijder vastzittend gras en vuil volledig.

Leg de gazonmaaier op zijn zijkant en maak de messen schoon. Verwijder samengeperst gras met een stuk hout of plastic.

Bewaar de grasmaaier op een droge plaats. Plaats geen andere voorwerpen op de machine.

Garantie

Voor Bosch-gereedschap geven wij garantie volgens de wettelijk geldende bepalingen (rekening of pakbon geldt als bewijs). Schade die terug te voeren is op natuurlijke slijtage, overbelasting of onoordeelkundig gebruik is van garantie uitgesloten.

Schade die door materiaal- of fabricagefouten ontstaan is, wordt gratis door levering van onderdelen of reparatie verholpen.

Reparaties kunnen alleen voor garantie in aanmerking komen wanneer het desbetreffende gereedschap in **volledig gemonteerde** staat wordt afgegeven of gezonden aan een erkende Bosch service-werkplaats of de importeur.

Gelijktijdig dient vermeld te worden dat aanspraak op garantie wordt gemaakt. Het volledig ingevulde garantiebewijs moet worden overgelegd.

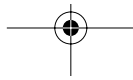



Milieubescherming



Bij de fabricage van de machine zijn milieutechnisch verantwoorde methoden toegepast.

Terugwinnen van grondstoffen in plaats van het weggooien van afval

Machine, toebehoren en verpakking moeten worden gesorteerd voor een voor het milieu verantwoorde recycling.

Deze gebruiksaanwijzing is vervaardigd van chloorvrij gebleekt kringlooppapier.

De kunststof delen zijn gekenmerkt om ze per soort te kunnen recyclen.

Klantenservice

Nederland

Robert Bosch B.V.
Postbus 502
NL-2132 AM Hoofddorp
Neptunusstraat 71
NL-2132 JP Hoofddorp

☎ +31 (0)23 / 56 56 620

Fax +31 (0)23 / 56 56 611

E-Mail: Gereedschappen@nl.bosch.com

België

Robert Bosch N.V.
After Sales Service Gereedschappen
Henri Genessestraat 1
BE-1070 Brussel

☎ +32 (0)2 / 525.50 29

Fax +32 (0)2 / 525.54.30

☎ Service conseil client +32 (0)2 / 525.53.07

E-Mail: Outillage.Gereedschappen@be.bosch.com

Wijzigingen voorbehouden

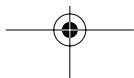
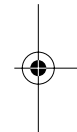
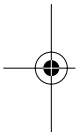



Sikkerhedsforskrifter



Gennemlæs denne vejledning grundigt.

Slå aldrig græs, mens der er nogen, især børn eller kæledyr, i nærheden. Gå altid - løb aldrig.

Betjen ikke plæneklipperen med bare fødder eller åbne sandaler.

Undersøg det område, hvor plæneklipperen skal anvendes, grundigt og fjern alle fremmedlegemer, der kan slynges væk af maskinen.

Man skal passe på ikke at miste fodfæstet på skrån timer. Slå aldrig græs på alt for stejle skrån timer.

Hold alle møtrikker, bolte og skruer stramme for at sikre, at plæneklipperen er i sikker arbejdsstand.

Udskift slidte eller beskadigede dele for en sikkerheds skyld.

Udvis forsigtighed ved justering af plæneklipperen for at undgå at få fødderne eller hænderne i klemme mellem bevægelige knive og faste dele af maskinen.

Tekniske data

Lydsvag plæneklipper	AHM 30	AHM 38	AHM 30C	AHM 38C
Bestillingsnummer	0 600 886 001	0 600 886 101	0 600 886 002	0 600 886 102
Knivbredde	30 cm	38 cm	30 cm	38 cm
Antal knive	4	4	5	5
Slåhøjde	12–40 mm	12–40 mm	15–43 mm	15–43 mm
Vægt	5,6 kg	7,3 kg	5,8 kg	7,5 kg

Foreskrevet anvendelse

Dette produkt er beregnet til privat plæneklipping.

Introduktion

Denne vejledning giver instruktioner om den korrekte samling og sikre anvendelse af plæneklipperen. Det er vigtigt at gennemlæse disse instruktioner omhyggeligt.

Når maskinen er helt samlet, vejer den ca. 5,6 kg - 7,5 kg. Få om nødvendigt hjælp med at fjerne den fra emballagen.

Vær forsigtig, når plæneklipperen bæres hen til plænen, da knivene er meget skarpe.

Maskinens dele

Maskinen fjernes forsigtigt fra emballagen. Kontrolér herefter at der ikke mangler noget:

- Plæneklipper
- Nederste del af grebet
- Øverste del af grebet
- 2 Midterstykker
- 6 Møtrikker
- 6 Skruer
- Betjeningsvejledning

Hvis nogle dele mangler eller er beskadigede, bedes du kontakte den forhandler, hvor du har købt maskinen.

Samling

A Fastgør den nederste del af grebet **1** i plæneklipperen.

B Fastgør midterstykkerne **3** til den øverste del af grebet **2** og herefter dette til den nederste del af grebet.

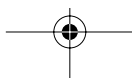
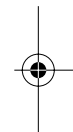



C Indstilling af slåhøjde

D Grovindstilling:

Fastgør borerne **4** i en af de tre positioner: **I** stor højde til ujævn græsplæne, **II** gennemsnitlig højde til normal græsplæne og **III** lav højde til lige græsplæne. Man behøver blot at indstille positionerne en gang. Finindstillingen kan benyttes til både langt og kort græs.

Højden ændres på følgende måde:

1. Fjern møtrikkerne **5** og skruerne.
2. Stil skruerne i den ønskede højde, så de passer til slåhøjden.
3. Fastgør møtrikkerne **5** igen.

D Finindstilling (X):

Løsne møtrikken **5** på begge sider af plæneklipperen. Forskyd de to borer **4** ensartet, indtil de befinder sig i den ønskede slåhøjde.

E Græsslåning

De bedste slåresultater opnås ved at starte helt ude ved plænenes kant og bevæge plæneklipperen. Græsslåningen afsluttes ved at vende for enden af banen og køre let tilbage hen over den tidligere bane.

Vedligeholdelse

Bemærk: For at sikre lang og pålidelig drift skal følgende vedligeholdelse udføres jævnligt.

Kontrollér jævnligt for tydelige defekter som f.eks. løse eller beskadigede knive, løse forbindelser og slidte eller beskadigede dele.

Kontrollér at dæksler og skærme ikke er beskadigede og at de er monteret rigtigt. Udfør evt. fornøden vedligeholdelse eller reparationer før brug.

Skulle græsslåmaskinen trods omhyggelig fabrikation og kontrol engang holde op med at fungere, skal reparationen udføres af et autoriseret serviceværksted for Bosch-elektroværktøj.

Det 10-cifrede bestillingsnummer for maskinen skal altid angives ved forespørgsler og bestilling af reservedele.

Indstilling af knive

Hvis græsset ikke slås rent og jævnt, skal klippecylindere justeres.

Drej de to indstillingsknapper **7** mod højre i små skridt, indtil spindelknivene **6** stryger let hen over den nederste kniv **8**.

Bemærk: Knivene fungerer som en saks.

Tilbehør

Græsboks AHM 30/38C 0 600 886 060

Græsboks AHM 30/38C 0 600 886 160

Efter græsslåning/Opbevaring

Rengør maskinen grundigt udvendigt med en blød børste og klud. Brug ikke vand, opløsningsmidler eller polermidler. Fjern alt græs og affald.

Vend maskinen om på siden og rengør knivområdet. Hvis der er sammenpresset, afklippet græs i knivområdet, skal det fjernes med et træ- eller plastikredskab.

Opbevar maskinen på et tørt sted. Anbring ikke andre genstande oven på maskinen.

Service og reparation

Vi yder garanti på Bosch-maskiner i henhold til de lovbestemmelser som gælder i det enkelte land (købsbevis skal fremlægges/medsendes).

Service og reparation uden beregning ydes indenfor garantiperioden iflg. dansk købelov under følgende forudsætninger:

- at den opståede defekt kan tilbageføres til konstruktions- eller materialefejl (normal slitage og misbrug kan ikke henføres herunder)
- at reparation ikke har været forsøgt udført af andre end Bosch-organisationens servicepersonale
- at der ikke har været anvendt uoriginale forsats- eller indsatsværktøjer.

Serviceydelse uden beregning omfatter udskiftning af defekte dele samt arbejds løn.

Værktøjet indleveres via Deres værktøjsforhandler eller indsendes for afsenders regning til Bosch serviceværkstedet. Betalbare reparationer udføres efter standardtider, som muliggør fast pris opgivet på forhånd.





Miljøbeskyttelse



Maskinen er blevet samlet på en miljøansvarlig måde.

Genbrug af råstoffer i stedet for bortskaffelse af affald

Maskinen, tilbehøret og emballagen skal sorteres for miljøvenlig genbrug.

Denne vejledning er skrevet på klorfrit genbrugspapir.

Kunststofdele er markeret for at garantere en ren-sorteret recycling.

Service

Bosch Service Center for el-værktøj
Telegrafvej 3
DK-2750 Ballerup

☎ Service: +45 44 89 88 55
Fax +45 44 89 87 55
☎ Teknisk vejledning: +45 44 89 88 56
☎ Den direkte line: +45 44 68 35 60

Ret til ændringer forbeholdes

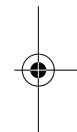
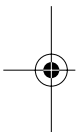



Säkerhetsanvisningar



Läs noggrant igenom anvisningarna nedan.

Använd aldrig gräsklipparen när personer, speciellt då barn, eller husdjur uppehåller sig i närheten. Gå alltid lugnt, spring inte.

Använd inte gräsklipparen barfota eller med öppna sandaler.

Undersök noggrant gräsmattan före klippning beträffande ovidkommande föremål som av maskinen eventuellt kan slungas iväg.

Se till att du står stadigt på sluttningar. Använd inte gräsklipparen på branta sluttningar.

Kontrollera att alla muttrar, bultar och skruvar är stadigt åtdragna; detta är förutsättningen för att gräsklipparen ska kunna fungera på rätt sätt.

Av säkerhetsskäl ska slitna eller skadade delar bytas ut.

Vid inställning av gräsklipparen se till att varken fötterna eller händerna kommer i kläm mellan rörliga knivar och fasta delar på gräsklipparen.

Tekniska data

Valsgräsklippare	AHM 30	AHM 38	AHM 30C	AHM 38C
Artikelnummer	0 600 886 001	0 600 886 101	0 600 886 002	0 600 886 102
Knivbredd	30 cm	38 cm	30 cm	38 cm
Antal knivar	4	4	5	5
Snitthöjd	12–40 mm	12–40 mm	15–43 mm	15–43 mm
Vikt	5,6 kg	7,3 kg	5,8 kg	7,5 kg

Ändamålsenlig användning

Denna gräsklippare är avsedd för hemmabruk.

Inledning

Denna instruktionsbok lämnar anvisningar för korrekt montage och säker användning av maskinen. Det är viktigt att du noggrant läser igenom anvisningarna.

Maskinen i monterat tillstånd väger ca 5,6 kg - 7,5 kg. Tillkalla eventuellt hjälp för att plocka upp maskinen ur förpackningen.

Se upp för de vassa knivarna när du bär gräsklipparen till gräsmattan.

Leveransen omfattar

Ta försiktigt ut gräsklipparen ur förpackningen och kontrollera att följande delar finns med:

- Gräsklippare
- Undre handtagsdel
- Övre handtagsdel
- 2 Mellanstycken
- 6 Muttrar
- 6 Skruvar
- Bruksanvisning

Saknas delar eller är de skadade ta genast kontakt med din återförsäljare.

Montage

- Montera undre handtagsdelen **1** på gräsklipparen.
- Sätt fast övre handtagsdelen **2** på mellanstyckena **3** och sedan på undre handtagsdelen.





C Inställning av snitthöjd

D Grovinställning:

Ställ in klämmorna för rullen **4** i en av de tre positionerna: **I** för hög snitthöjd på ojämn gräsmatta, **II** för medelhög snitthöjd på normal gräsmatta och **III** för låg snitthöjd på jämn gräsmatta. Det räcker att ställa in positionerna en enda gång. Fininställningen kan användas både för långt och för kort gräs.

Ändra höjden på följande sätt:

1. Ta bort vingmuttrarna **5** och skruvarna.
2. Sätt åter in skruvarna på önskad höjd motsvarande snitthöjden.
3. Dra åter fast vingmuttrarna **5**.

D Fininställning (X):

Lossa vingmuttern **5** på gräsklipparens båda sidor. Flytta jämnt de båda klämmorna för rullen **4** till önskad snitthöjd.

E Gräsklippning

Bästa resultatet uppnås om du börjar klippningen vid gräsmattans kant, går rakt fram och svänger. Fortsätt sedan klippningen med lätt överlappning av föregående bana.

Underhåll

Märk: Lång och tillförlitlig drift kan endast garanteras om följande underhållsarbeten regelbundet utförs.

Kontrollera regelbundet gräsklipparen avseende defekter som t ex lösa eller skadade knivar, lösa förbindelser och nedslitna eller skadade delar.

Kontrollera att täckkåpor och skyddsanordningar är felfria och korrekt monterade. Eventuellt nödvändiga servicearbeten och reparationer ska utföras innan maskinen tas i bruk.

Om i gräsklipparen trots exakt tillverkning och sträng kontroll störning skulle uppstå, bör reparation utföras av auktoriserad serviceverkstad för Bosch- eller verktyg.

Var vänlig ange vid förfrågningar och reservdelsbeställningar apparatens artikelnummer som består av 10 tecken.

Inställning av kniv

Valsknivarna måste efterjusteras om gräset inte längre klipps snyggt och jämnt.

Vrid båda ställknapparna **7** medurs i små steg tills spindelknivarna **6** stryker lätt över undre kniven **8**.

Märk: Knivarna fungerar som en sax.

Tillbehör

Gräsuppsamlingskorg	
AHM 30/38C.....	0 600 886 060
Gräsuppsamlingskorg	
AHM 30/38C.....	0 600 886 160

Efter gräsklippning/förvaring

Rengör gräsklipparen utvändigt noggrant med en mjuk borste och en trasa. Använd inte vatten och inte heller lösnings- eller polermedel. Rengör gräsklipparen från gräsrester och föroreningar.

Lägg upp gräsklipparen på sidan och rengör området kring knivarna. Avlägsna ihoppresat gräs med en trä- eller plastbit.

Uppbevara gräsklipparen på en torr plats. Ställ inga andra föremål på maskinen.

Leverantörsansvar

För Bosch verktygsprodukter lämnas garanti enligt respektive lands gällande föreskrifter (måste styrkas med kvitto, faktura eller följesedel).

Har produkten köpts och brukats enligt konsumentköplagens bestämmelser så gäller lagens bestämmelser.

Leverantörsansvaret gäller fabrikations- och materialfel. Skador som orsakats av överbelastning eller osakkunnigt handhavande och normalt slitage omfattas ej av leverantörsansvaret.

Vid reklamation ska produkten inlämnas till närmaste auktoriserade serviceverkstad i **odemonterat** skick.





Miljöhänsyn



Vid maskinens tillverkning har ur miljösynpunkt riskfria metoder tillämpats.

Återvinning i stället för avfallshantering

Maskinen, tillbehörsdelarna och förpackningen ska sorteras för miljövänlig återvinning.

Denna bruksanvisning är tryckt på klorfritt returpapper.

För att underlätta sortering vid återvinning är plastdelarna markerade.

Kundtjänst

Robert Bosch AB
Isafjordsgatan 15
Box 11 54
S-164 22 Kista

☎ Växel: +46 (0)8 / 7 50 15 00

☎ Kundtjänst: +46 (0)8 / 7 50 18 20

Ändringar förbehålles

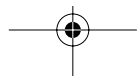
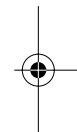
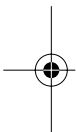



Sikkerhetsinformasjoner



Les nøye gjennom de nedenstående anvisningene.

Slå aldri gress når det oppholder seg personer - særskilt barn - eller husdyr like i nærheten. Gå alltid rolig, ikke løp.

Ikke bruk gressklipperen barbert eller med åpne sandaler.

Undersøk området som skal klippes nøye og fjern alle fremmedlegemer som kan slynges bort av gressklipperen.

Sørg for å stå stødig i skråninger. Ikke klipp i særskilt bratte skråninger.

Sørg for at alle mutre, bolter og skruer sitter godt fast, slik at gressklipperen alltid befinner seg i en sikker arbeidstilstand.

For sikkerhets skyld må slitte eller skadede deler skiftes ut.

Ved innstilling av gressklipperen må du unngå å føtter eller hender klemmes fast mellom de bevegelige knivene og de faststående delene til gressklipperen.

Tekniske data

Sylinderklipper	AHM 30	AHM 38	AHM 30C	AHM 38C
Bestillingsnummer	0 600 886 001	0 600 886 101	0 600 886 002	0 600 886 102
Knivbredde	30 cm	38 cm	30 cm	38 cm
Antall kniver	4	4	5	5
Klippehøyde	12–40 mm	12–40 mm	15–43 mm	15–43 mm
Vekt	5,6 kg	7,3 kg	5,8 kg	7,5 kg

Formålmessig bruk

Dette produktet er beregnet for gressklipping på private eiendommer.

Innledning

Denne håndboken inneholder anvisninger om korrekt montasje og sikker bruk av gressklipperen. Det er viktig at du leser disse informasjonene nøye.

Gressklipperen veier ca. 5,6 kg - 7,5 kg i ferdig montert tilstand. Sørg om nødvendig for å få hjelp til å løfte gressklipperen ut av forpakningen.

Vær forsiktig med de skarpe knivene når du bærer gressklipperen bort til gressplenen.

Dette inngår i leveransen

Ta gressklipperen forsiktig ut av forpakningen og kontrollér at du har fått nedenstående deler:

- Gressklipper
- Håndtak-underdel
- Håndtak-overdel
- 2 Midtdeler
- 6 Mutre
- 6 Skruer
- Bruksanvisning

Hvis deler mangler eller er skadet, må du henvende deg til din forhandler.

Montering

- Fest underdelen av håndtaket **1** på gressklipperen.
- Fest overdelen av håndtaket **2** på midtdelene **3** og deretter på underdelen av håndtaket.



C Innstilling av klippehøyden

D Grovinnstilling:

Fest føringene **4** i en av de tre posisjonene: **I** stor høyde for ujevne plener, **II** middels høyde for normal plen og **III** liten høyde for jevn plen. Det er tilstrekkelig å innstille posisjonene en enkelt gang. Fininnstillingen kan både brukes for høyt og lavt gress.

Høyden endres på følgende måte:

1. Fjern vingemutterne **5** og skruene.
2. Sett skruene i ønsket høyde som tilsvarer klippehøyden.
3. Fest vingemutterne **5** igjen.

D Fininnstilling (X):

Løs vingemutterne **5** på begge sider av gressklipperen. Forskyv de to føringene **4** jevnt til ønsket klippehøyde.

E Klipping

Optimale klipperresultater oppnås når du begynner med klippingen på kanten av gressplenen. Snu på slutten av banen og gå slik tilbake at den siste banen overlappes litt.

Vedlikehold

Merk: Utfør følgende servicearbeider med jevne mellomrom, for å sikre en lang og pålitelig bruk.

Kontrollér gressklipperen regelmessig med hensyn til tydelige feil som f. eks. løse eller skadede kniver, løse forbindelser og slitte eller skadede deler.

Kontrollér at deksler og verneinnretninger ikke er skadet og er korrekt plassert. Utfør eventuelle vedlikeholds- eller reparasjonsarbeider før gressklipperen tas i bruk.

Skulle gressklipperen svikte til tross for omhyggelige produksjons- og kontrollmetoder, må reparasjonen utføres av et autorisert serviceverksted for Bosch-elektroverktøy.

Ved alle forespørsler og reservedelsbestillinger må du absolutt oppgi maskinens 10-sifrede bestillingsnummer.

Innstilling av knivene

Spindelknivene må justeres på nytt når gresset ikke lenger klippes rett og jevnt.

Skru begge innstillingsknappene **7** i små skritt med urviserne, til spindelkniven **6** stryker svakt over nedre kniv **8**.

Merk: Knivene fungerer som en saks.

Tilbehør

Gressoppsamler AHM 30/38C 0 600 886 060
Gressoppsamler AHM 30/38C 0 600 886 160

Etter klippingen/oppbevaring

Gressklipperens utvendige deler må rengjøres grundig med en myk børste og en klut. Ikke bruk vann og løse- eller polermidler. Fjern alle gressrester og partikler.

Legg gressklipperen på siden og rengjør knivområdet. Sammenpresset gress fjernes med en tre- eller plastbit.

Oppbevar gressklipperen på et tørt sted. Ikke sett andre gjenstander på maskinen.

Garanti

For Bosch-maskiner ytes det garanti i henhold til de lovbestemte/nasjonale bestemmelser (vedlegg regning eller følgeseddél). Skader som kan tilbakeføres til naturlig slitasje, overbelastning eller usakkyndig behandling er utelukket fra garantien.

Ved skader som er oppstått på grunn av material- eller produksjonsfeil blir det enten levert et nytt produkt eller produktet blir reparert gratis.

Klager kan bare godtas hvis maskinen blir sendt til leverandøren eller til et godkjent kundeverksted for elektriske verktøy i **montert** tilstand.

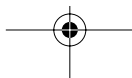



Miljøvern



Denne maskinen ble produsert etter økologiske metoder.

Råstoffgjenvinning i stedet for avfallsdeponering

Maskinen, tilbehørdelene og forpakningen bør sorteres for en miljøvennlig resirkulering.

Denne bruksanvisningen er laget av klorfritt resirkulert papir.

For å kunne resirkulere på en skikkelig måte, er kunststoffdelene markerte.

Kundeservice

Robert Bosch A/S
Trollaaerveien 8
Postboks 10
N-1414 Trollaaen
☎ Kundekonsulent: +47 66 81 70 00
Fax..... +47 66 81 70 97

Rett til endringer forbeholdes

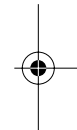
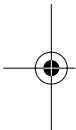



Turvaohjeet



Lue alla olevat ohjeet tarkasti.

Älä koskaan leikkaa ruohoa, jos välittömässä läheisyydessä on muita henkilöitä, varsinkin lapsia tai kotieläimiä. Kävele aina rauhallisesti, älä koskaan juokse.

Älä käytä ruohonleikkuria paljain jaloin äläkä avoimissa sandaaleissa.

Tarkista leikattava pinta huolellisesti ja poista kaikki vieraat esineet, joita ruohonleikkuri saattaisi singota ympärilleen.

Varmista tukeva kulku kaltevassa pinnassa. Älä leikkaa ruohoa jyrkissä rinteissä.

Varmista kaikkien muttereiden, pulttien ja ruuvien kiireys ruohonleikkurin pitämiseksi turvallisessa toimintakunnossa.

Vaihda kuluneet tai vaurioituneet osat turvallisuuden varmistamiseksi.

Vältä, konetta säädettäessä, jalkojen tai käsien joutumista liikkuvien terien ja leikkurin kiinteiden osien väliin puristukseen.

Tekniset tiedot

Sylinterileikkuri	AHM 30	AHM 38	AHM 30C	AHM 38C
Tilausnumero	0 600 886 001	0 600 886 101	0 600 886 002	0 600 886 102
Terän leveys	30 cm	38 cm	30 cm	38 cm
Terien lukumäärä	4	4	5	5
Leikkauskorkeus	12–40 mm	12–40 mm	15–43 mm	15–43 mm
Paino	5,6 kg	7,3 kg	5,8 kg	7,5 kg

Asianmukainen käyttö

Tämä tuote on tarkoitettu ruohonleikkaukseen kotitalouksissa.

Johdanto

Tässä käsikirjassa annetaan ohjeita oikeasta kokoonpanosta ja ruohonleikkurin turvallisesta käytöstä. On tärkeää, että luet nämä ohjeet huolella.

Täysin kokoonpantu kone painaa n. 5,6 kg - 7,5 kg. Pyydä tarvittaessa apua koneen poistamiseksi pakkauksestaan.

Varo teräviä teriä kantaessasi ruohonleikkurin nurmikolle.

Toimitukseen kuuluu

Nosta ruohonleikkuri varovasti pakkauksesta ja tarkista, että siitä löytyy seuraavat tarvikkeet:

- Ruohonleikkuri
- Kahvan alaosa
- Kahvan yläosa
- 2 Keskikappaleet
- 6 Mutterit
- 6 Ruuvit
- Käyttöohje

Jos jokin osa puuttuu tai on vaurioitunut, ota yhteys jälleenmyyjääsi.

Kokoonpano

- A** Kiinnitä kahvan alaosa **1** ruohonleikkuriin.
- B** Kiinnitä kahvan yläosa **2** keskikappaleisiin **3** ja tämän jälkeen kahvan alaosaan.



G Leikkuukorkeuden säätäminen

D Karkea säätö:

Kiinnitä ohjaimet **4** yhteen kolmesta asennosta:
I suuri korkeus epätasaista nurmikkoa varten,
II keskikorkeus tavallista nurmikkoa varten ja
III pieni korkeus tasaista nurmikkoa varten.
Riittää, että asento asetetaan kerran. Hienosäätöä voidaan käyttää sekä pitkän että lyhyen ruohon kanssa.

Muuta korkeutta seuraavasti:

1. Poista siipimutterit **5** ja ruuvit.
2. Siirrä ruuvit leikkauskorkeutta vastaavalle korkeudelle.
3. Kiinnitä siipimutterit **5** uudelleen.

D Hienosäätö (X):

Avaa siipimutterit **5** ruohonleikkurin kummallakin puolella. Siirrä kaksi ohjainta **4** saman verran halutulle leikkauskorkeudelle.

E Ruohonleikkuu

Paras mahdollinen ruohonleikkuutulos saavutetaan, kun ruohonleikkuu aloitetaan nurmikon reunasta ja edetään suoraan eteenpäin sekä käännetään. Leikkuu jatketaan sitten edellistä rataa vähän limittäen.

Huolto

Ohje: Pitkäaikaisen ja luotettavan käytön varmistamiseksi tulee suorittaa seuraavat huoltotoimenpiteet säännöllisin väliajoin.

Tarkista säännöllisin väliajoin ilmeiset viat, kuten irtotai vaurioituneet terät, huonot liitokset ja loppuunkuluneet tai vialliset osat.

Tarkista, että suojuukset ja turvalaitteet ovat kunnossa ja oikein asennettuja. Suorita tarvittavat huolto- ja korjaustoimet ennen käyttöä.

Jos ruohonleikkuriin, huolellisesta valmistus- ja koestusmenetelmästä huolimatta tulee vika, on korjaus annettava Bosch-sähkötyökalut keskuskuollon suoritettavaksi.

Ilmoita ehdottomasti laitteen 10-numeroinen tilausnumero kaikissa kyselyissä ja varaosatilauksissa!

Leikkuuterien säätö

Leikkuusylinteriä tulee säätää, jos ruohonleikkuri ei enää leikkaa puhtaasti ja tasaisesti.

Kierrä molempia säätönuppeja **7** pienin askelin myötäpäivään, kunnes akselin terä **6** kevyesti raa-paisee alaterää.

Ohje: Terät toimivat saksien tapaan.

Tarvikkeet

Ruohonkeruusäiliö AHM 30/38C..... 0 600 886 060

Ruohonkeruusäiliö AHM 30/38C..... 0 600 886 160

Ruohonleikkuun jälkeen/säilytys

Puhdista ruohonleikkuri perusteellisesti ulkopuolelta pehmeällä harjalla ja rievulla. Älä käytä vettä, äläkä liuottimia tai kiillotusaineita. Poista kaikki ruohokerääntymät ja hiukkaset.

Aseta ruohonleikkuri kyljelleen ja puhdista teräalue. Poista pakkautunut ruoho puu- tai muoviesineellä.

Säilytä ruohonleikkuri kuivassa paikassa. Älä aseta mitään muita esineitä koneen päälle.

Takuu

Myönnämme Bosch-laitteille laki-/maakohtaisten määräysten mukaisen takuun.

Takuu koskee raaka aine- ja valmistusvirheitä. Takuuaika alkaa koneen ostopäivästä. Mahdollisen takuukorjauksen yhteydessä pyydämme esittämään ostokuitin tai vastaavan todisteen ostopäivästä.

Takuu raukeaa, jos jokin muu kuin valtuutettu huoltoliike ryhtyy korjaustoimenpiteisiin takuun aikana.

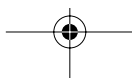



Ympäristönsuojelu



Ruohonleikkurin valmistuksessa on käytetty ympäristön kannalta oikeita menetelmiä.

Raaka-aineen uusiokäyttö jätehuollon asemasta

Kone, tarvikkeet ja pakkaus tulisi lajitella ympäristöystävällisen kierrätyksen mahdollistamiseksi.

Nämä käyttöohjeet on valmistettu kloorittomasti valkaistusta uusiopaperista.

Lajipuhdasta kierrättämistä varten muoviosissa on merkinnät.

Asiakaspalvelu

Robert Bosch OY
Keskushuolto/Sähkötyökalut
Pakkalantie 21A
FIN-01510 Vantaa

☎ +358 (0)9 / 27 05 34 61

☎ +358 (0)9 / 27 05 34 62

☎ +358 (0)9 / 27 05 34 63

Fax..... +358 (0)9 / 8 70 23 18

Pidätämme oikeuden muutoksiin

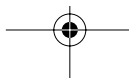
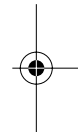
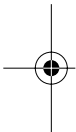



Υποδείξεις ασφάλειας



Διαβάστε προσεκτικά όλες τις επόμενες οδηγίες.

Μην εργάζεσθε ποτέ με το μηχάνημα όταν σε κοντινή απόσταση βρίσκονται άλλα άτομα, ιδιαίτερα παιδιά, ή κατοικίδια ζώα. Βαδίζετε πάντα ήσυχα, μην τρέχετε ποτέ.

Μη χρησιμοποιείτε το χλοοκόπτη όταν είσθε ξυπόλυτοι/τες ή όταν φοράτε ανοιχτά πέδιλα.

Ελέγξτε προσεκτικά την υπό κοπή επιφάνεια και απομακρύνετε όλα τα ξένα αντικείμενα που μπορεί να εμπλακούν στο μηχάνημα και να εκσφενδονιστούν απ' αυτό.

Δίνετε ιδιαίτερη προσοχή στη σταθερή στάση του σώματός σας όταν εργάζεσθε σε επικλινείς επιφάνειες. Μη κόβετε σε ιδιαίτερα απότομες επιφάνειες.

Εξασφαλίζετε τη σταθερότητα (το σφίξιμο) όλων των παξιμαδιών, των πύρων και των βιδών, για να παραμένει ο χλοοκόπτης συνεχώς σε κατάσταση άψογης λειτουργίας.

Για λόγους ασφαλείας αντικαθιστάτε τυχόν φθαρμένα ή χαλασμένα εξαρτήματα.

Όταν ρυθμίζετε το μηχάνημα προσέχετε να μην εμπλακούν τα πόδια σας ή τα χέρια σας ανάμεσα στα κινητά μαχαίρια και τα σταθερά τμήματα του μηχανήματος.

Χαρακτηριστικά μηχανήματος

Χλοοκόπτης	AHM 30	AHM 38	AHM 30C	AHM 38C
Κωδικός αριθμός	0 600 886 001	0 600 886 101	0 600 886 002	0 600 886 102
Φάρδος μαχαιριού	30 cm	38 cm	30 cm	38 cm
Αριθμός μαχαιριών	4	4	5	5
Ύψος κοπής	12–40 mm	12–40 mm	15–43 mm	15–43 mm
Βάρος	5,6 kg	7,3 kg	5,8 kg	7,5 kg

Χρήση σύμφωνα με τον προορισμό

Το προϊόν αυτό προορίζεται για την κοπή γρασιδιού στον ιδιωτικό τομέα.

Εισαγωγή

Το εγχειρίδιο αυτό περιέχει οδηγίες σχετικά με η σωστή συναρμολόγηση και τον ασφαλή χειρισμό του μηχανήματός σας. Η προσεκτική ανάγνωση αυτών των οδηγιών είναι σημαντική.

Το μηχάνημα ζυγίζει, όταν είναι τελείως συναρμολογημένο, 5,6 kg - 7,5 kg περίπου. Αν χρειασθεί, ζητήστε βοήθεια για να βγάλετε το μηχάνημα από τη συσκευασία του.

Δίνετε προσοχή στα κοφτερά μαχαίρια όταν μεταφέρετε το χλοοκόπτη στο γρασίδι.

Συσκευασία

Βγάλτε το χλοοκόπτη προσεκτικά από τη συσκευασία και ελέγξτε, αν υπάρχουν όλα τα παρακάτω εξαρτήματα:

- Χλοοκόπτης
- Κάτω μέρος χειρολαβής
- Επάνω μέρος χειρολαβής
- 2 Κεντρικά βάρτρα
- 6 Παξιμάδια
- 6 Βίδες
- Οδηγίες χρήσης

Αν λείπουν εξαρτήματα ή αν εξαρτήματα είναι χαλασμένα σας παρακαλούμε να απευθυνθείτε στον έμπορό σας.

Συναρμολόγηση

A Στερεώστε το κάτω μέρος **1** της χειρολαβής στο χλοοκόπτη.

B Στερεώστε το επάνω μέρος **2** της χειρολαβής στα κεντρικά βάρτρα **3** και ακολούθως στο κάτω μέρος της χειρολαβής.



C Ρύθμιση του ύψους κοπής

D Προσεγγιστική ρύθμιση:

Στερεώστε τους οδηγούς **4** σε μια από τις τρεις θέσεις: **I** μεγάλο βάθος για ανομοιόμορφο/ ανώμαλο γρασίδι, **II** μέτριο ύψος για σύνηθες, κανονικό γρασίδι και **III** χαμηλό ύψος για ομαλό/ επίπεδο γρασίδι. Αρκεί, αν ρυθμίσετε τις θέσεις μόνο μια φορά. Η ακριβής ρύθμιση μπορεί να διεξαχτεί και για το μεγάλο και για το κοντό χορτάρι.

Ρυθμίστε το ύψος ως εξής:

1. Απομακρύνετε τα παξιμάδια με μοχλό **5** και τις βίδες.
2. Μετακινήστε τις βίδες, ανάλογα με το ύψος κοπής, στο επιθυμητό ύψος.
3. Ξανασιφίξτε τις βίδες με μοχλό **5**.

D Ακριβής ρύθμιση (X):

Λύστε τα παξιμάδια με μοχλό **5** στις δυο πλευρές του χλοοκόπτη. Μετακινήστε ομοιόμορφα τους δυο οδηγούς **4** στο επιθυμητό ύψος κοπής.

E Κοπή

Άψογα αποτελέσματα κοπής πιτυγχάνονται όταν αρχίζει την κοπή του γρασιδιού από το πριθώριο και, πρπατώντας προς τα μπρός. Ακολουθώντας, στο τέρμα καθ λωρίδας, γυρίζει πίσω και συνεχίζει την κοπή πικαλύπτοντας λαφρά την προηγούμενη λωρίδα.

Συντήρηση

Υπόδειξη: Διεξάγετε τακτικά τις παρακάτω εργασίες συντήρησης, για να εξασφαλιστεί μια μακρόχρονη και ασφαλής χρήση.

Ελέγχετε το χλοοκόπτη τακτικά, μήπως παρουσιάζει εμφανείς ελλείψεις, όπως χαλαρά ή χαλασμένα μαχαίρια, χαλαρές συνδέσεις και χαλασμένα ή φθαρμένα τμήματα.

Ελέγχετε, αν οι καλύπτρες και οι προστατευτικές διατάξεις είναι σώες και σωστά συναρμολογημένες. Πριν από κάθε χρήση διεξάγετε ενδεχομένως τυχόν απαραίτητες εργασίες συντήρησης ή επισκευής.

Αν παρόλες τις επιμελημένες μεθόδους κατασκευής και ελέγχου ο χλοοκόπτης σταματήσει κάποτε, τότε η επισκευή του πρέπει να ανατεθεί σ' ένα εξουσιοδοτημένο συνεργείο ηλεκτρικών συσκευών της Bosch.

Όταν ζητάτε διασαφητικές πληροφορίες και όταν παραγγέλλετε ανταλλακτικά, παρακαλούμε να αναφέρετε οπωσδήποτε το 10ψήφιο κωδικό αριθμό που υπάρχει στην πινακίδα κατασκευαστή!

Υπόδειξη των μαχαιριών κοπής

Τα μαχαίρια του άξονα πρέπει να τροχιστούν εκ νέου όταν το χορτάρι δεν κόβεται πλέον καθαρά και ομοιόμορφα.

Περιστρέψτε και τα δυο κουμπιά ρύθμισης **7** λίγο-λίγο με φορά ίδια μ' εκείνη των δεικτών του ρολογιού ώσπου τα μαχαίρια **6** του άξονα ν' αγγίζουν ελαφρά το κάτω μαχαίρι **8**.

Υπόδειξη: Τα μαχαίρια λειτουργούν σαν ψαλίδι.

Ειδικά εξαρτήματα

Κάλαθος υποδοχής κομμένης χλόης
AHM 30/38C 0 600 886 060

Κάλαθος υποδοχής κομμένης χλόης
AHM 30/38C 0 600 886 160

Μετά την κοπή/Διαφύλαξη

Καθαρίστε συστηματικά το χλοοκόπτη εξωτερικά με μια μαλακή βούρτσα κι ένα πανί. Μη χρησιμοποιείτε νερό, διαλύτες ή στιλβωτικά μέσα. Απομακύντε όλα τα προσκολλημένα χορτάρια και μικροαντικείμενα.

Τοποθετήστε το χλοοκόπτη με την πλευρά στο δάπεδο και καθαρίστε την περιοχή των μαχαιριών. Αφαιρέστε το συμπιεσμένο κομμένο υλικό μ' ένα κομμάτι ξύλο ή πλαστικό.

Διαφυλάξτε το χλοοκόπτη σ' ένα στεγνό χώρο. Μην τοποθετείτε άλλα αντικείμενα επάνω στο μηχάνημα.





Εγγύηση

Για τα εργαλεία Bosch παρέχουμε εγγύηση σύμφωνα με την (στο κάθε κράτος) ισχύουσα νομοθεσία (επιβεβαίωση αγοράς με το τιμολόγιο ή με το δελτίο αποστολής).

Η κάλυψη βλαβών που προέρχονται από φυσιολογική φθορά, υπερφόρτιση ή κακή μεταχείριση, δεν περιλαμβάνεται στην εγγύηση. Βλάβες που προέκυψαν λόγω ελαττωματικού υλικού ή σφάλματος της κατασκευής, αποκαθίστανται με δωρεάν αντικατάσταση των ελαττωματικών ανταλλακτικών ή τη δωρεάν επισκευή.

Παράπονα γίνονται δεκτά μόνον όταν αποσταλεί το εργαλείο χωρίς να έχει ανοιχτεί στον προμηθευτή ή σε αναγνωρισμένο συνεργείο της Bosch για ηλεκτρικά εργαλεία ή εργαλεία πεπιεσμένου αέρα.

Προστασία περιβάλλοντος



Κατά την κατασκευή του μηχανήματος εφαρμόστηκαν διαδικασίες ακίνδυνες για το περιβάλλον.

Ανακύκλωση πρώτων υλών αντί απόσυρση απορριμάτων

Το μηχάνημα, τα εξαρτήματα που ανήκουν σ' αυτό και η συσκευασία θα πρέπει να ταξινομούνται για να ανακυκλωθούν με τρόπο φιλικό προς το περιβάλλον (Recycling).

Αυτές οι οδηγίες χρήσης έχουν τυπωθεί σε ανακυκλωμένο χαρτί λευκασμένο χωρίς χλώριο.

Για την ανακύκλωση κατά είδος τα πλαστικά μέρη του μηχανήματος φέρουν ένα σχετικό χαρακτηρισμό.

Υπηρεσία εξυπηρέτησης πελατών (Service)

Robert Bosch A.E.
Κηφισσού 162
12131 Περιστέρι-Αθήνα

☎ +30 (0)1 / 57 70 081-3
Fax +30 (0)1 / 57 70 080

ABZ Service A.E.

☎ +30 (0)1 / 57 70 081-83
☎ +30 (0)1 / 57 01 375-78
Fax +30 (0)1 / 57 73 607

Τηρούμε το δικαίωμα αλλαγών





Güvenlik talimatı



Aşağıdaki talimatı dikkatlice okuyun.

Yakınızda başkaları, özellikle de çocuklar veya evcil hayvanlar varken asla biçme yapmayın. Sakince yürüyerek biçme yapın, hızlı hareket etmeyi.

Çim biçme makinesini çıplak ayakla veya açık sandaletlerle kullanmayın.

Biçme yapacağınız alanı iyice kontrol edin ve alet tarafından savrulabilecek her türlü yabancı madde ve cisim temizleyin.

Eğimli yerlerde duruş pozisyonunuzun güvenli olmasına ve yere sağlam basmaya dikkat edin. Çok dik eğimli yerlerde biçme yapmayın.

Çim biçme makinesinin güvenli biçimde çalışması için bütün somun, vida ve civataları sıkın.

Güvenliğiniz için yıpranmış ve hasar görmüş parçaları değiştirin.

Aleti ayarlarken el veya ayaklarınızın bıçaklar arasına veya aletin hareketli parçalarının arasına sıkışmamasına dikkat edin.

Teknik veriler

Sessiz çim biçme makinesi	AHM 30	AHM 38	AHM 30C	AHM 38C
Sipariş no.	0 600 886 001	0 600 886 101	0 600 886 002	0 600 886 102
Bıçak genişliği	30 cm	38 cm	30 cm	38 cm
Bıçak sayısı	4	4	5	5
Kesme yüksekliği	12–40 mm	12–40 mm	15–43 mm	15–43 mm
Ağırlığı	5,6 kg	7,3 kg	5,8 kg	7,5 kg

Usulüne uygun kullanım

Bu ürün evlerde ve özel alanlarda çim biçme için geliştirilmiştir.

Giriş

Bu el kitapçığı, aletinizin doğru montajı ve güvenli kullanımına ilişkin talimatı içerir. Bu talimatı dikkatlice okumanız çok önemlidir.

Bu alet monte edilmiş durumda yaklaşık 5,6 kg - 7,5 kg'dır. Aleti ambalajından çıkarmak için gerektiğinde yardım isteyin.

Bıçaklar keskin olduğundan aleti biçme yapılacak yere taşırken dikkatli olun.

Teslimat kapsamı

Çim biçme makinesini ambalajından dikkatle çıkarın ve aşağıdaki parçaların tam olup olmadığını kontrol edin:

- Çim biçme makinesi
- Tutamak alt parçası
- Tutamak üst parçası
- 2 Orta parça
- 6 Somun
- 6 Vida
- Kullanma kılavuzu

Eğer parçalar eksik veya hasarlı ise lütfen yetkili satıcınıza başvurun.

Montaj

A Tutamak alt parçasını **1** çim biçme makinesine tespit edin.

B Tutamak üst parçasını **2** önce orta parçalara **3** sonra tutamak üst parçasına tespit edin.



C Kesme yüksekliğinin ayarı

D Kaba ayar:

Kılavuzları 4 üç pozisyondan birinde tespit edin: **I** Düz olmayan yüzeylerdeki çimler için büyük yükseklik, **II** Normal yüzeylerdeki çimler için orta yükseklik ve **III** Düz yüzeylerdeki çimler için düşük yükseklik. Pozisyonları bir kez ayarlamak yeterlidir. Hassas ayarlama hem uzun hem de kısa çimlerde uygulanabilir.

Yüksekliği şu şekilde değiştirin:

1. Kelebek somunları 5 ve vidaları çıkarın.
2. Vidaları biçme yüksekliğine göre istediğiniz yüksekliğe getirin.
3. Kelebek somunları 5 tekrar tespit edin.

D Hassas ayar (X):

Çim biçme makinesinin her iki yanındaki kelebek somunları 5 gevşetin. Her iki kılavuzu 4 aynı anda istediğiniz biçme yüksekliğine itin.

E Çim biçme

Biçilecek çim alanının kenarından biçmeye başlayıp ileri harfi çizerseniz en iyi biçme sonucunu elde edersiniz. Biçtiğiniz kuşağın sonuna gelince, geriye doğru bir kez daha aynı kuşağın üzerinden hafifçe gidin.

Bakım

Uyarı: Aleti uzun süre ve güvenli biçimde kullanabilmek için aşağıdaki işlemleri düzenli olarak yapın.

Çim biçme makinesini görünür hatalar, örneğin gevşek veya hasarlı bıçaklar, yıpranmış veya hasar görmüş parçalar açısından kontrol edin.

Muhafazaların ve koruyucu donanımların hasarlı olup olmadıklarını ve doğru olarak takılıp takılmadıklarını kontrol edin. Aleti kullanmadan önce gerekli olan bakım ve onarım işlemlerini yerine getirin.

Titiz üretim ve test yöntemlerine rağmen çim biçme makinesi arıza yapacak olursa, onarımı Bosch elektrikli el aletleri için yetkili bir Bosch Servisine yaptırın.

Bütün başvuru ve yedek parça siparişlerinizde lütfen aletin 10 haneli sipariş numarasını mutlaka belirtin!

Bıçakların ayarlanması

Çim temiz ve düzenli olarak kesilmiyorsa, milli bıçağın bilenmesi gerekir.

Her iki ayar düğmesini 7 kademeler halinde, silindirik bıçak 6 alt bıçağı 8 hafifçe yalayacak biçimde, saat hareket yönünde çevirin.

Uyarı: Bıçaklar bir makas gibi işlev görür.

Aksesuar

Çim tutma selesi AHM 30/38C 0 600 886 060

Çim tutma selesi AHM 30/38C 0 600 886 160

Biçmeden sonra muhafaza

Çim biçme makinesinin dışını yumuşak bir fırça ve bezle esaslı biçimde temizleyin. Su, çözücü madde veya polisaj maddesi kullanmayın. Alete yapışmış bulunan bütün çim kalıntılarını ve parçacıkları temizleyin.

Çim biçme makinesini yan yatırın ve bıçak alanını temizleyin. Sıkışmış çimleri bir tahta veya plastik parça ile temizleyin.

Çim biçme makinesini kuru bir yerde saklayın. Aletin üzerine yabancı bir madde veya parça koymayın.

Garanti

Bosch elektrikli el aletleri için, yasal hükümler çerçevesinde, malzeme ve üretim hatalarından kaynaklanan hasarlar için garanti veriyoruz.

Normal yıpranma, aşırı zorlanma veya usulüne aykırı kullanmadan kaynaklanan hasarlar garanti kapsamında değildir. Malzeme veya üretim hatalarından kaynaklanan hasarlar, hatalı parça veya aletin kendisinin verilmesi veya onarımı yoluyla telafi edilir.

Garantiye ilişkin talepler ancak, alet **sökülmeden** teslimatçı veya Bosch'un pnömatik veya elektrikli el aletleri müşteri servis atölyelerinden birine gönderildiği takdirde kabul edilebilir.



Çevre koruma



Bu alet üretilirken ekolojik dengeyi koruyan yöntemler kullanılmıştır.

Çöp tasfiyesi yerine hammadde kazanımı

Alet, aksesuarı ve ambalajı çevre koruyucu bir Recycling işlemi için tasnif edilmelidir.

Bu kullanım talimatı da, klor kullanılmadan ağartılmış, yeniden dönüşümlü kâğıda basılmıştır.

Değişik malzemelerin tam olarak ayrılıp, yeniden değerlendirme işlemine sokulabilmesi için, plastik parçalar işaretlenmiştir.

Müşteri servisi

Bosch San. ve Tic. A.S.
Ahi Evran Cad. No:1 Kat:22
Polaris Plaza
TR-80670 Maslak/Istanbul

☎ +90 (0)216 / 335 06 00

Faks +90 (0)216 / 346 00 48-49

Değişiklikler mümkündür





BOSCH 

Robert Bosch GmbH
Geschäftsbereich Elektrowerkzeuge
D-70745 Leinfelden-Echterdingen
www.bosch-pt.com

F016 L69 768 (01.02) O / 48
Printed in England

