

















Pos. A153/A175	Teil	Maß	Stück
A		Spreizbolzen straddling bolt	8x
B		VB Gehäuse Ø15 VB cap Ø15	8x
C		Kunststoff-Fuß / 35 mm hoch plastic leg / 35 mm	4x
D		Euroschraube 6,3x19 Euro-screw 6,3x19	4x
E		Riffeldübel Ø8x35 ripple dowel	12x
F		Wedgefix-Verbinder assembly fitting / wedgefix	8x
G		Wedgefix-Einsteckdübel wedgefix dowel	8x
H		Spax-Schraube 3,5x20 Flako spax screw / countersunk head	2x
I		Kippsicherung suspension fitting	1x
J		Spax 4,5x15 Ruko spax screw / round head 4,5x15	2x

Pos. A153/A175	Teil	Maß	Stück
K		Schraubhaken 65mm angle hook	1x
L		Kunststoff Dübel Ø8 plastic plug	1x
M		Verbindungs-Schraube / Bierbach 5,0x29,5 VB-screw / Bierbach 5,0x29,5	4x
N		Kunststoff-Abdeckkappen Ø5 cover cap Ø5	4x
O		Kunststoff-Abdeckkappen Ø12 cover cap Ø12	4x
P		Kunststoff-Rückwandhalter RV8 Plastic-back-wall holder RV8	2x
Q		Kunststoff-Abdeckkappen Ø8 cover cap Ø8	4x



3

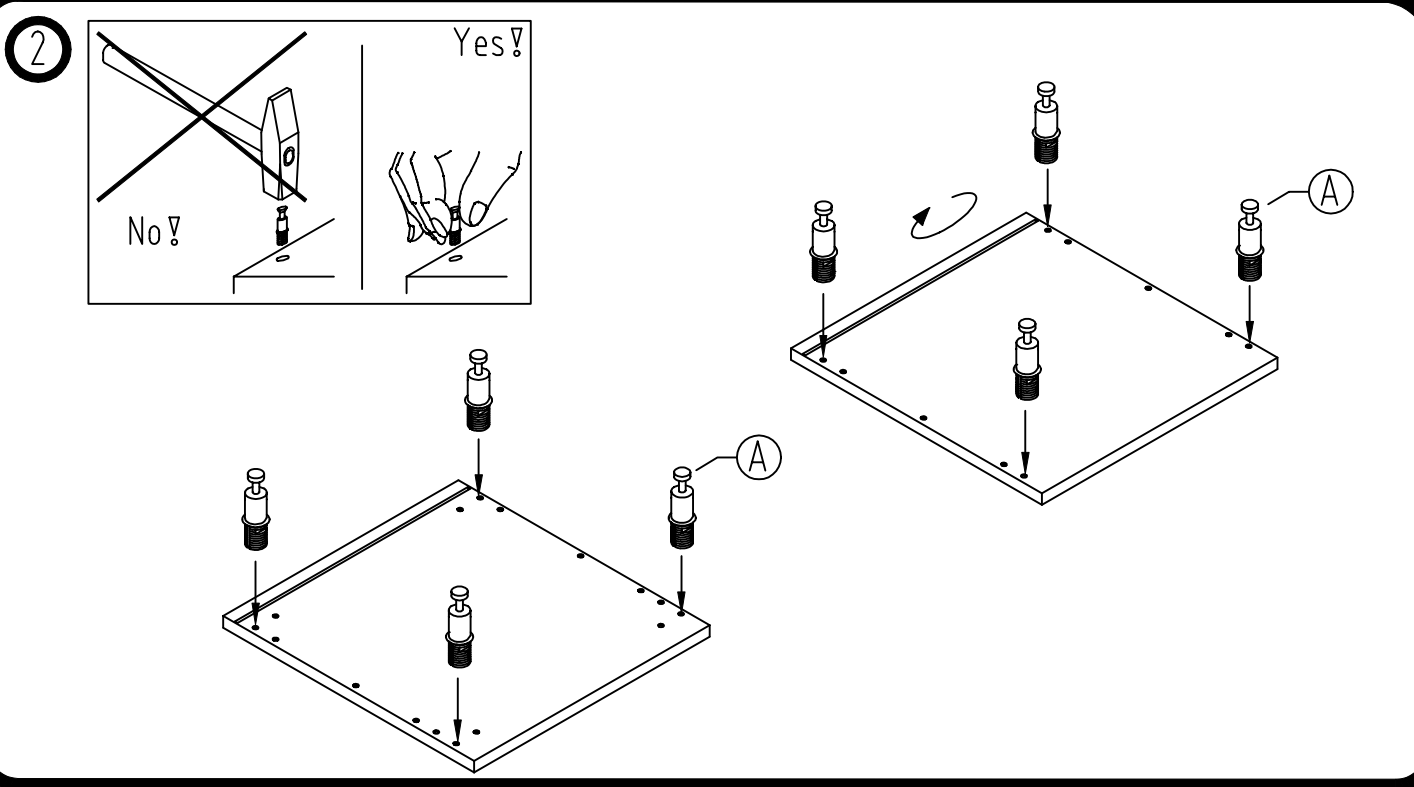
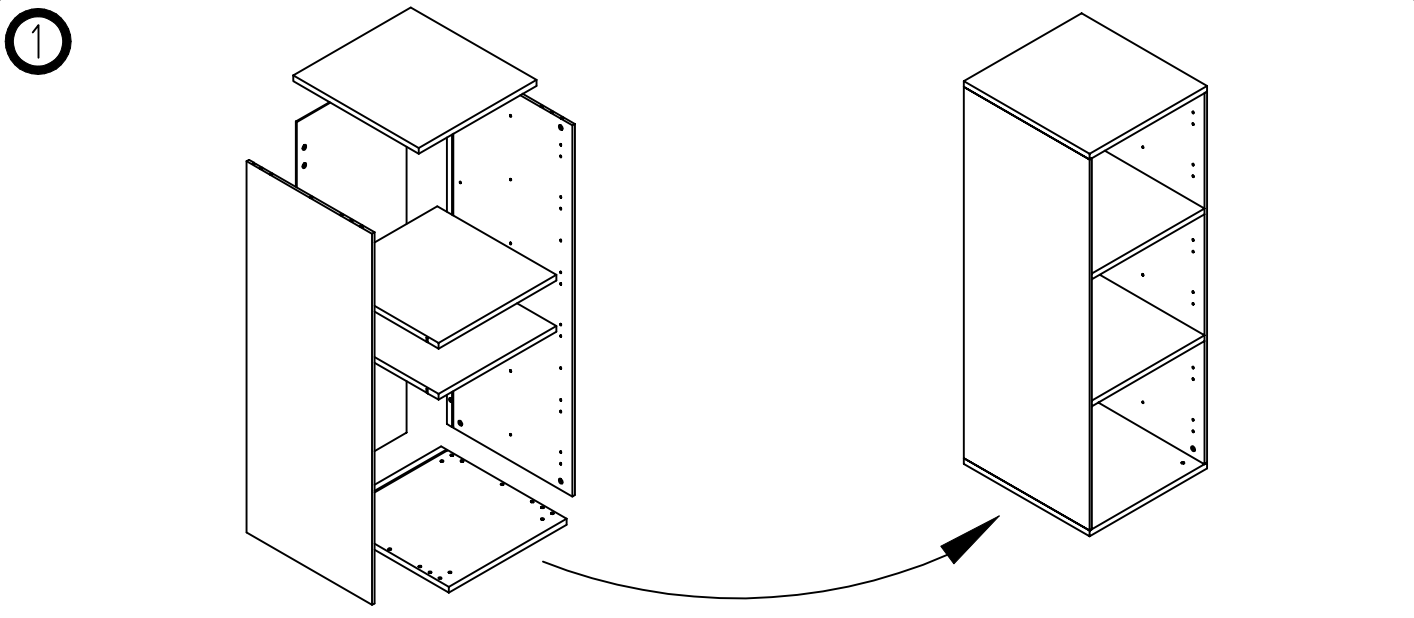
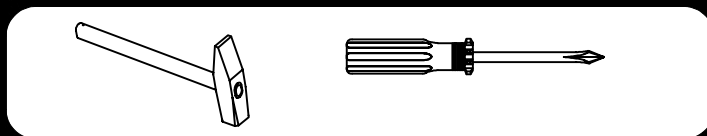
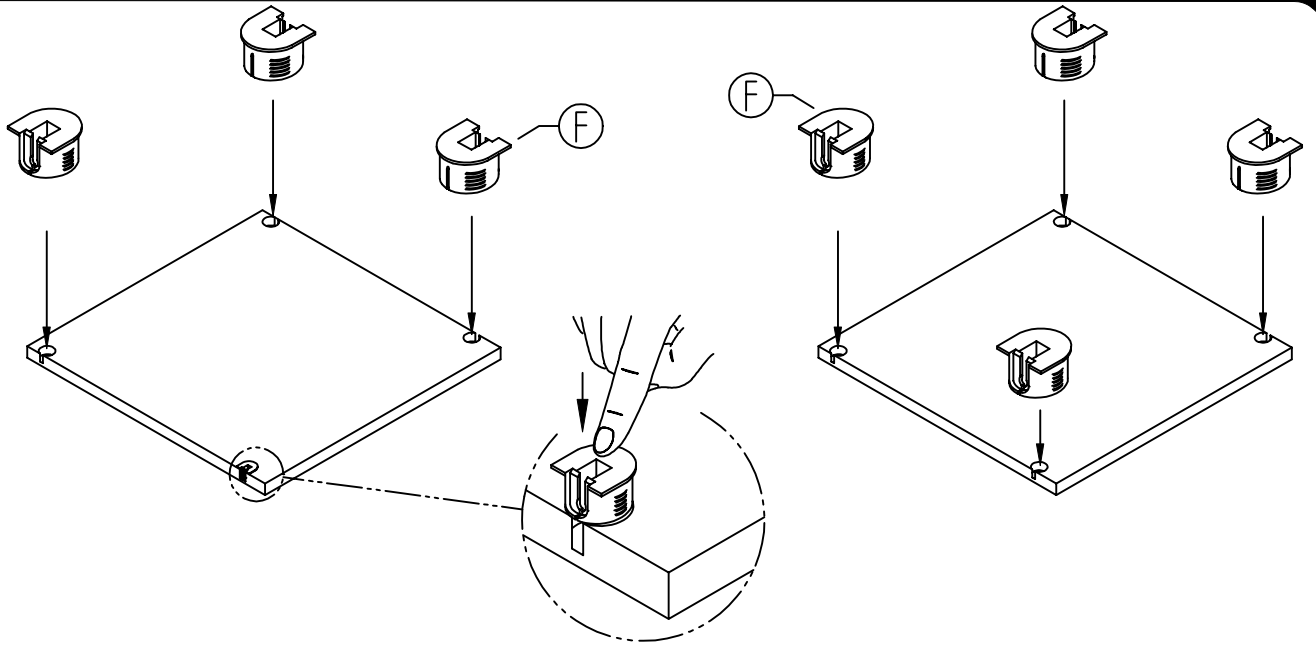

4

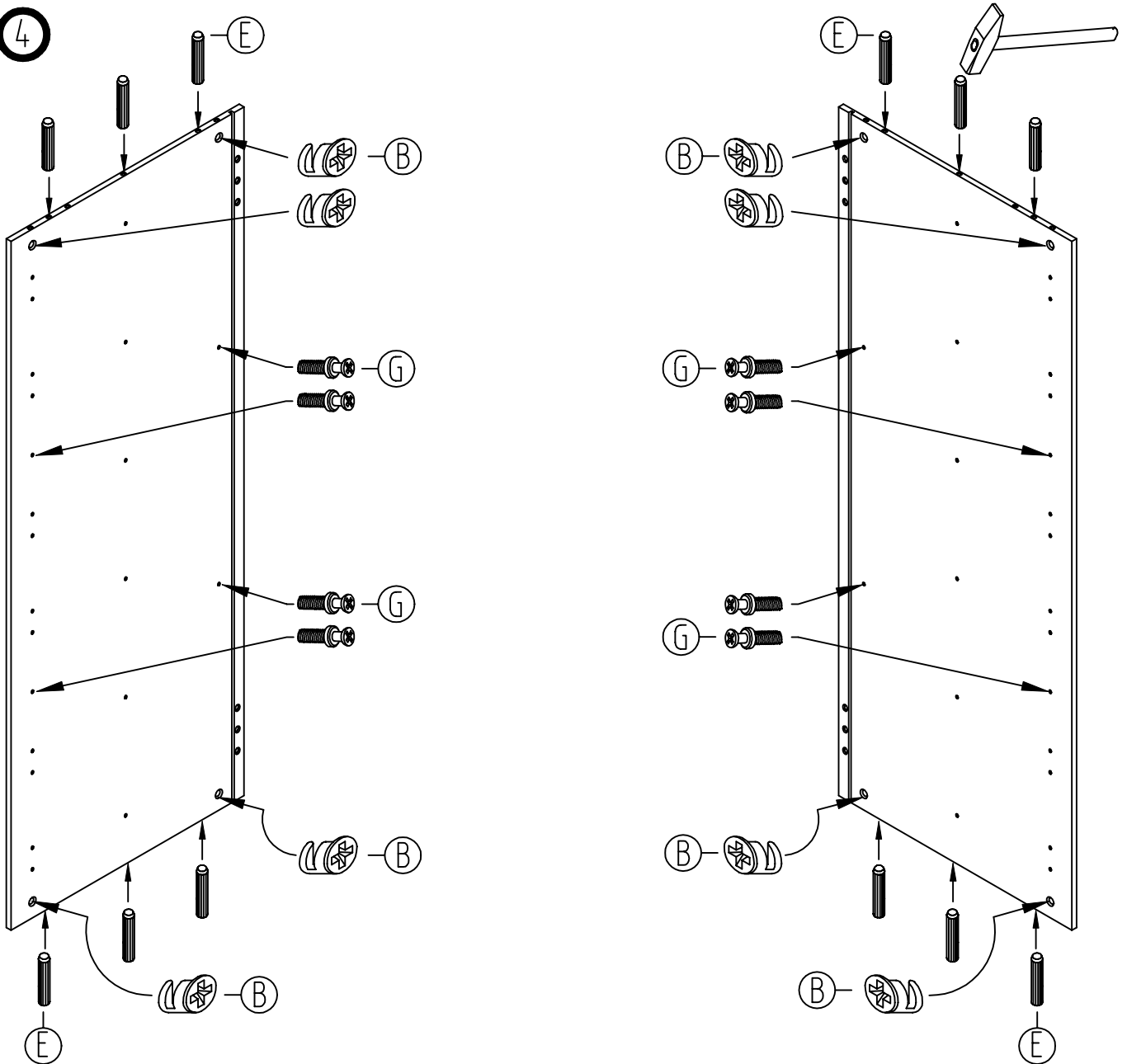

5

Achtung:
Bohrung vorhanden = unterer Boden
Attention = plinth base

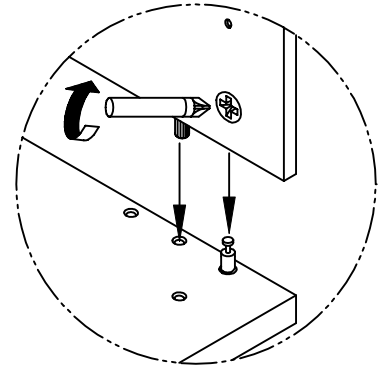
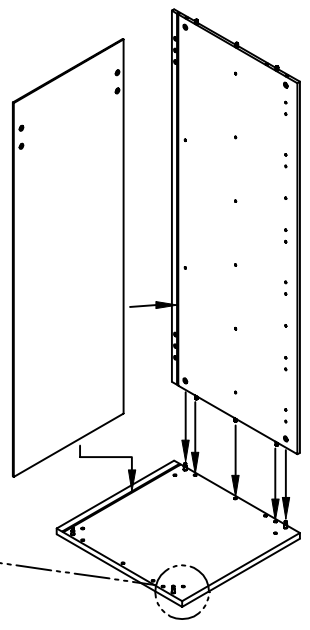
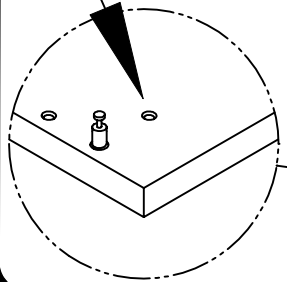

6

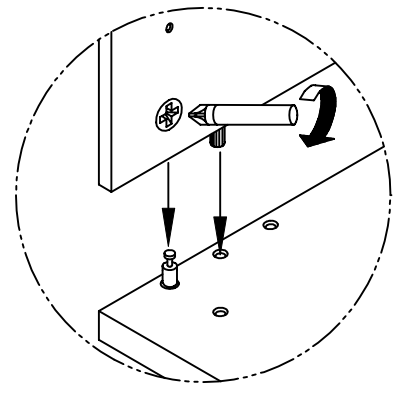
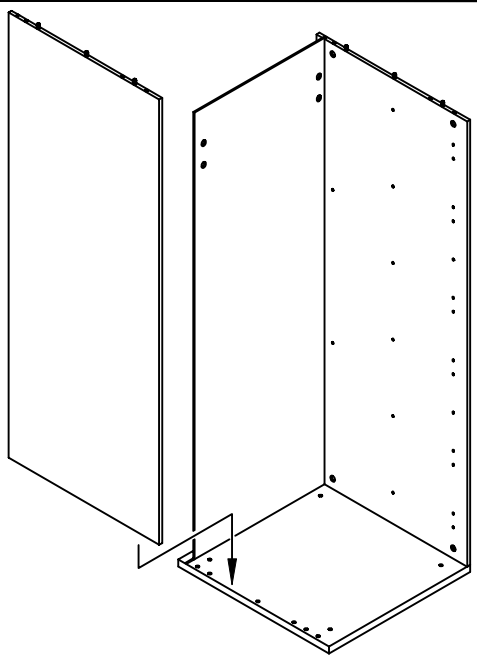

7

