























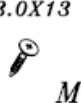



IBIZA 65

Instrukcja montażu
Montageanleitung
Instructions D'assemblage
Assembly instructions

4027.282-285 IBIZA SCHRANK 4T WEISS



 A	 B	 C	 D	 E	 F	 G	6.3X11  H	 I	 J
12	24	24	34	10	8	8	8	16	6
 K	 L	3.0X13  M	 N	 X	3.0X30  O	4.0X16  P	 Q	 R	3.5X35  S
6	2	2	4	6	8	16	2	1	7
3.5X13  T	 U	 Z	 A1						
32	8	6	6						

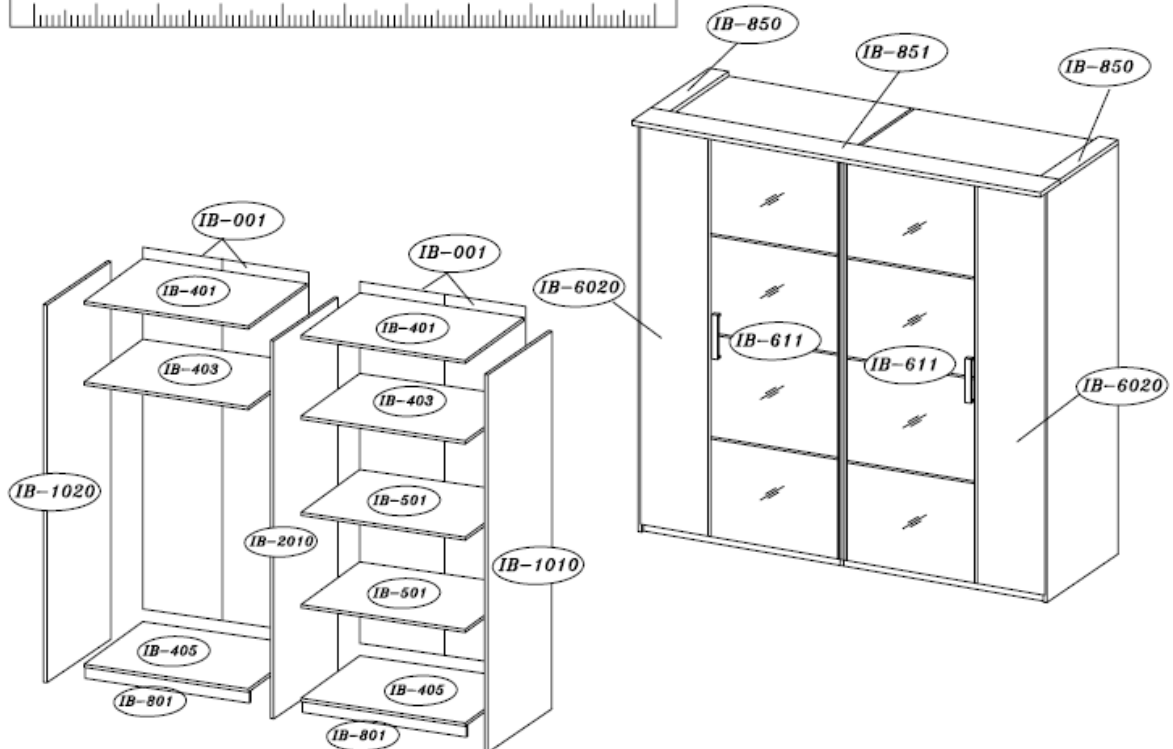
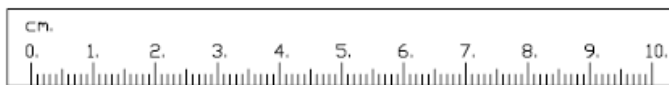

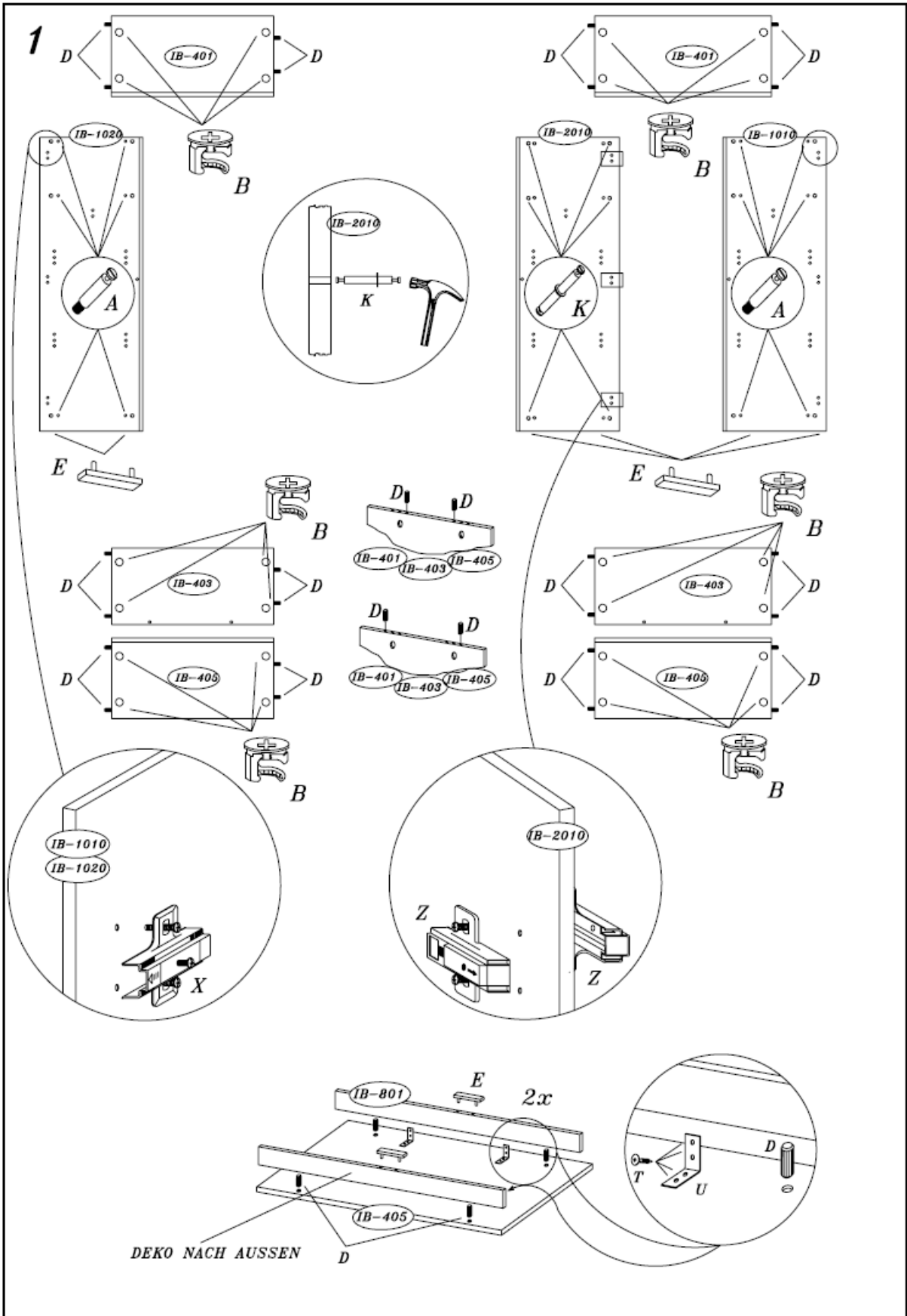

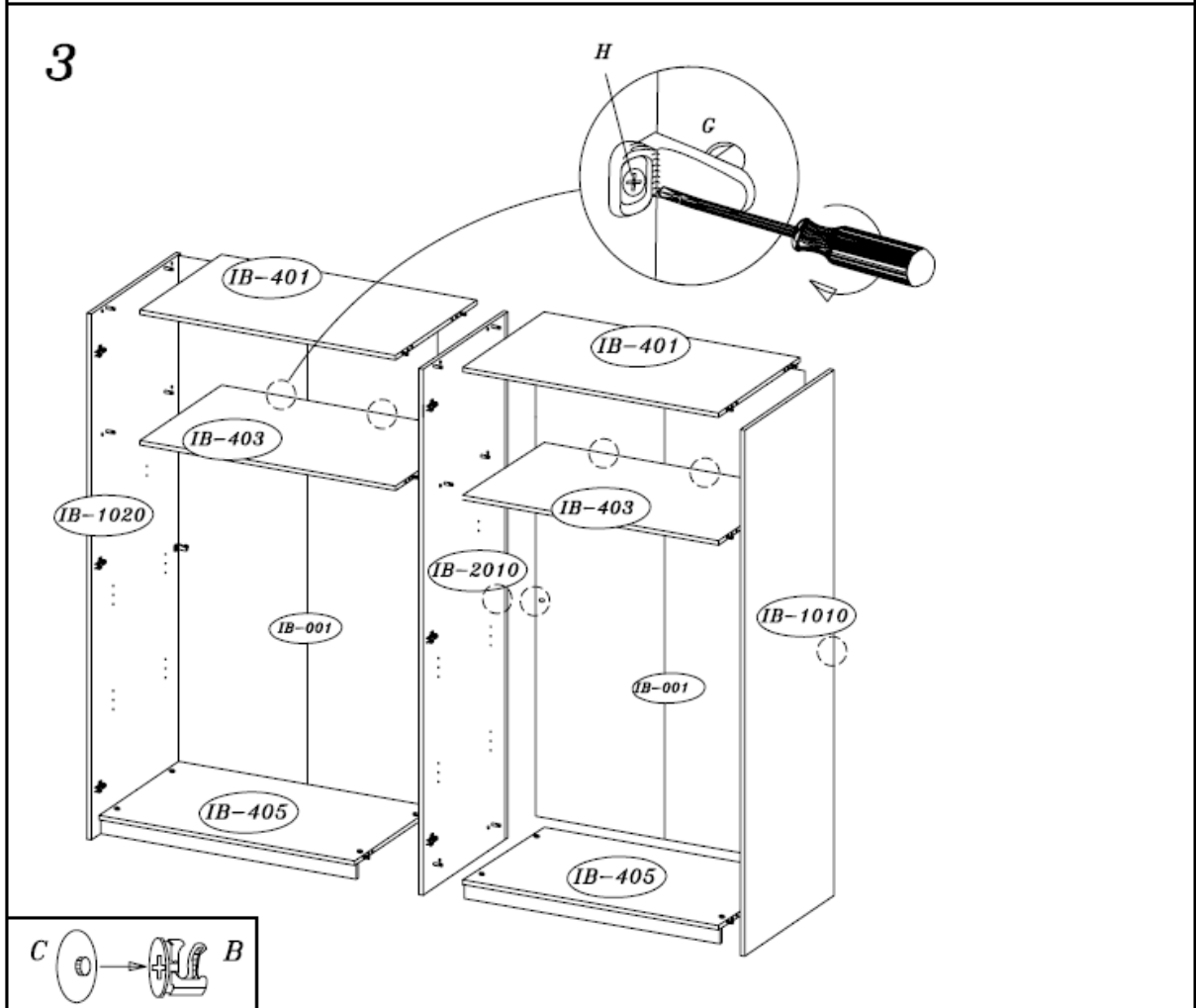
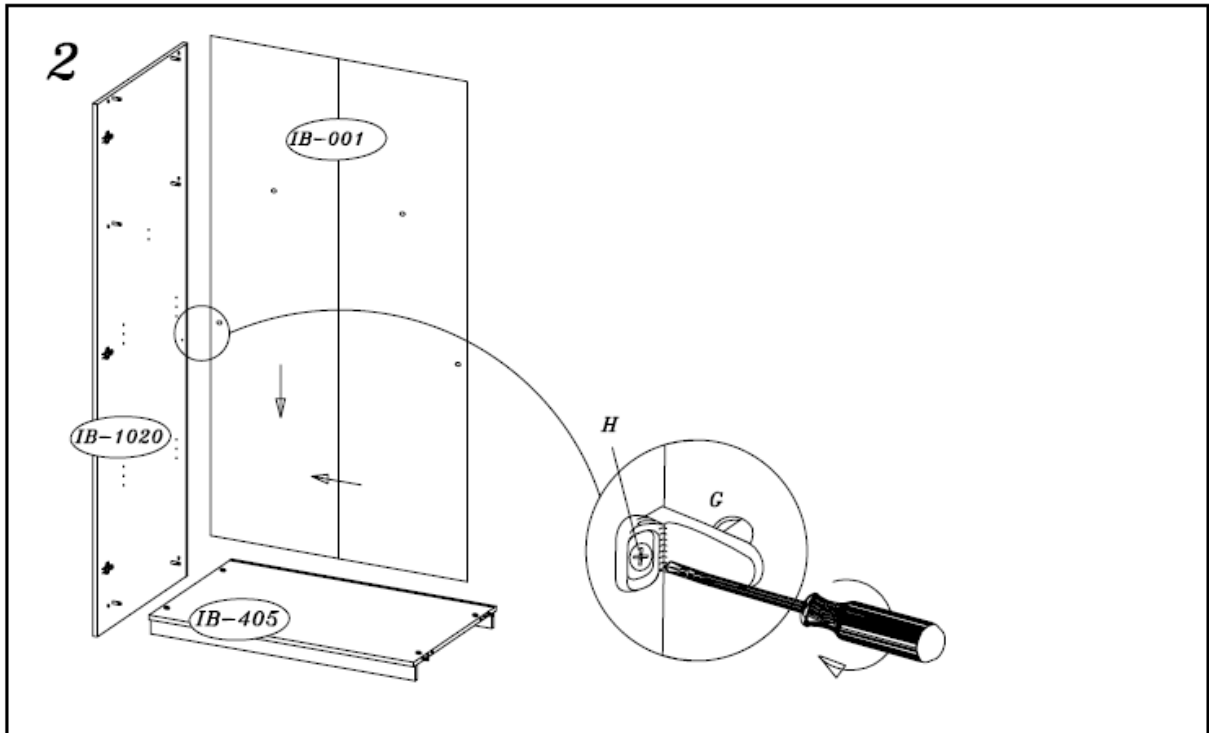

4

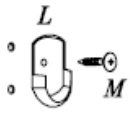
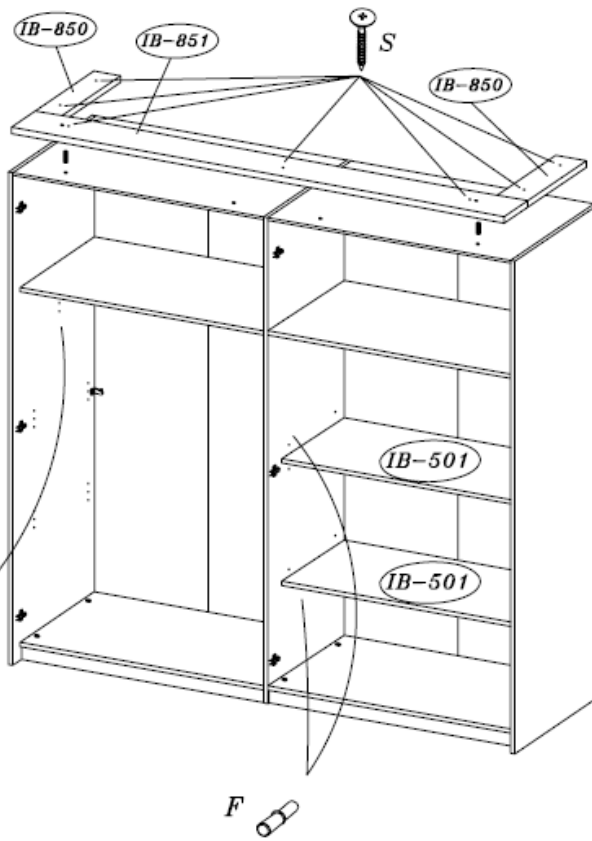

5

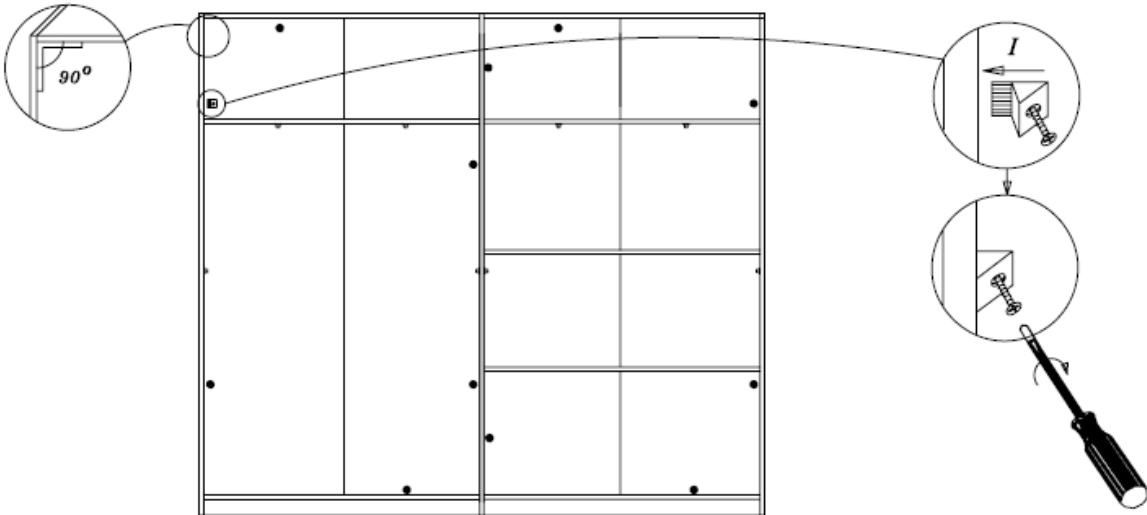

- PUNKTY MOCOWANIA ZACZEPÓW ŚCIAN TYLNYCH
- BEFESTIGUNGSPUNKTE DER RUCKWANDHALTER INNEN
- LES POINTS PRISE (CROCHET) DE TAILLE DERRIERE

6

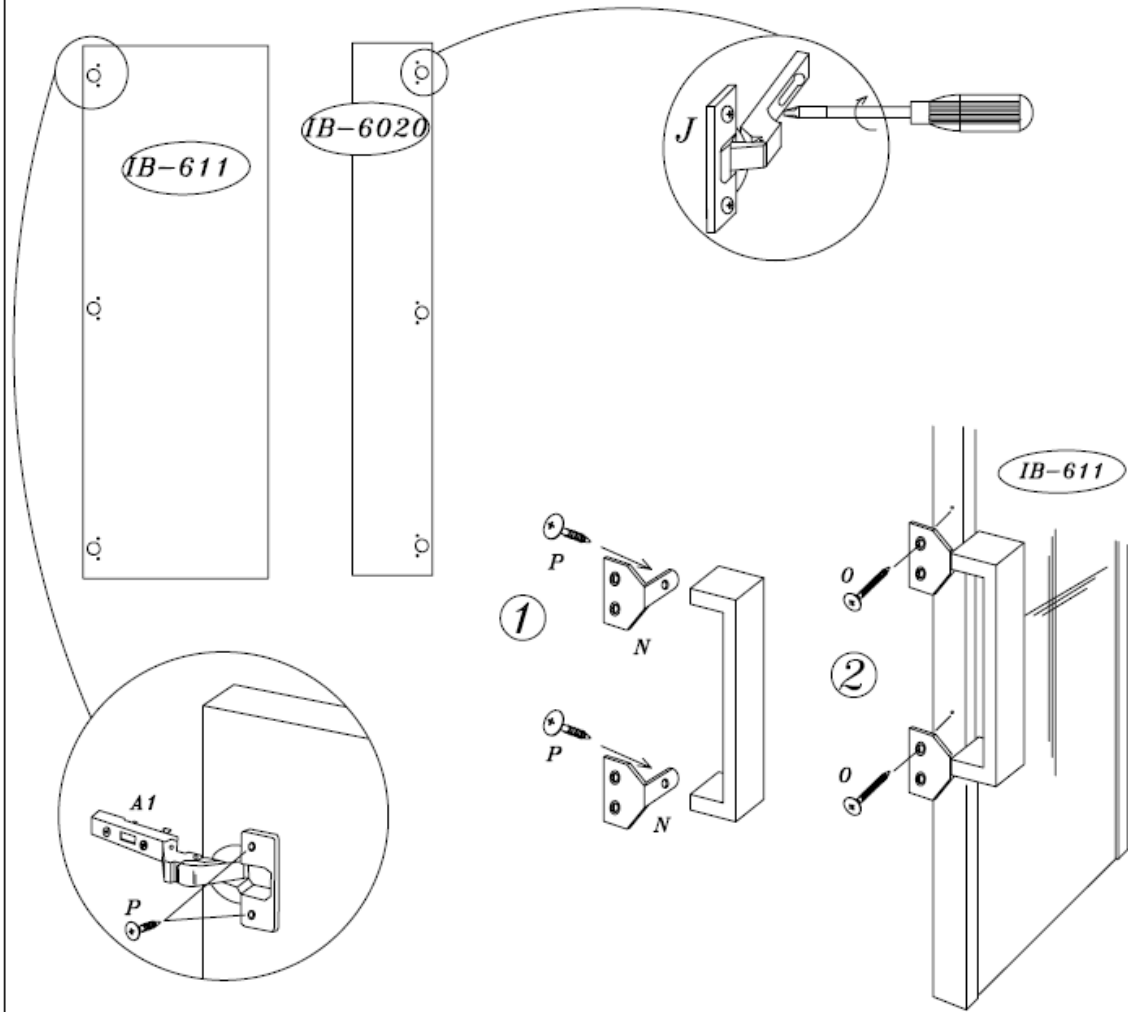

VERSTELLMÖGLICHKEITEN

- ▷ FUGENVERSTELLUNG
SCHRAUBE -B- EINSTELLEN, SCHRAUBE -A- ANZIEHEN
 - ↳ TIEFENVERSTELLUNG:
BEFESTIGUNGSSCHRAUBE -A- LOCKERN, BANDAM NACH VORNE ODER
RÜKWÄRTS VERSCHIEBEN, SCHRAUBE -A- ANZIEHEN SCHRAUBE -B-
MIT EINER 1/4 DREHUNG NACH RECHTS ARRETIEREN.
 - ◊ NUR MIT PLATEN, DIE IN DER HOHE VERSTELLT WERDEN KÖNNEN)
BEFESTIGUNGSSCHRAUBE -C- LOCKERN, HOHE EINSTELLEN,
SCHRAUBE -C- ANZIEHEN
- POSSIBILITES DE REGLAGE**
- ▷ REGLAGE DU JOINT
REGLER AVEC LA VIS -B-, SERRER AVEC LA VIS -A-
 - ↳ REGLAGE DE LA PROFONDEUR
DESERRER LA VIS -A- ET ENSUITE AJUSTER EN POUSSANT OU TIRANT
LA CHARNIERE, SERRER LA VIS -A- ET LA FIXER EN TOURNANT
LA VIS -B- 1/4 DE TOUR VERS LA DROITE.
 - ◊ REGLAGE DE LA HAUTEUR (SEULEMENT AVEC PLATEAUX DE BASE AMOVIBLES)
DESERRER LES VIS DE FIXATION -C- ET ENSUITE AJUSTER LA HAUTEUR, SERRER
DE NOUVEAU LES VIS -C-

HINGES CONTROL

- ▷ TO ALIGN DOORS AT SIDE PANELS
- LOOSEN SCREW -A-
- MOVE DOORS TO FRONT OR TO BACK TIGHTEN SCREW A
- ↳ TO ALIGN DOORS AT CENTER JOINT
- LOOSEN SCREW A
- TURN SCREW B ABOUT 1/4 ROTATION TO THE RIGHT
- TIGHTEN SCREW A
- ◊ TO SET THE DOORS VERTICALLY
- LOOSEN SCREW C
- MOVE THE DOORS UP AND DOWN
- TIGHTEN SCREW C

REGULACJA ZAWIAS

- ▷ USTAWIENIE SZCZELINY MIĘDZY DRZWIAMI, A FRONTOWA PŁASZCZYZNA
BOKU LUB PRZEGRODY.
POLUZNIC SRUBE -A-
- PRZESUNAC DRZWI W PRZOD LUB W TYŁ, PO USTAWIANIU SZCZELINY
DOKRECIC SRUBE -A-
- ↳ USTAWIENIE SZCZELINY MIĘDZY DRZWIAMI
POLUZNIC SRUBE -A-
- PRZEKREC SRUBE -B- 1/4 OBROTU W PRAWA STRONE
- DOKRECIC SRUBE -A-
- ◊ USTAWIENIE DRZWI W PIONIE
- POLUZNIC SRUBY -C-
- PRZESUNAC DRZWI W GORE LUB W DOL.
- DOKREC SRUBY -C-

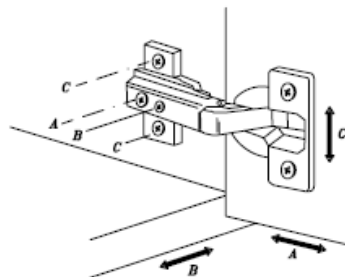

SERVICEKARTE

Modellname:
IBIZA 65

Artikel-Nr.:
4027.282-285 IBIZA SCHRANK 4T WEISS

Type: (falls vorhanden)

























Farb-Nr.: (falls vorhanden)

Liebe Kundin, lieber Kunde,

obwohl wir unsere Möbel vor der Auslieferung einer eingehenden Endkontrolle unterziehen, kann es vorkommen, dass einmal ein Zubehörtteil fehlt oder dass ein Teil während des Transports beschädigt wird. **Senden Sie den Artikel in so einem Fall bitte nicht zurück**, sondern fordern Sie einfach Ersatz für das fehlende bzw. beschädigte Teil bei unserer **Kunden - Hotline** an. Die Telefonnummer finden Sie auf den **Serviceseiten** im aktuellen Katalog.

Bitte nennen Sie bei der Ersatzteilbestellung **Modellnamen, Artikelnummer, Type und Farbnummer** des Möbelstückes sowie die benötigten **Ersatzteilnummern /- bezeichnungen**, wie sie in dieser Anleitung angegeben sind.

Wir werden ihre Anforderung sofort bearbeiten und Ihnen das Ersatzteil umgehend zusenden.

									
12	24	24	34	10	8	8	8	16	6
									
6	2	2	4	6	8	16	2	1	7
									
32	8	6	6						

Teile - Nr.	Bezeichnung	Anzahl
IB-1010	RECHTE SEITE	1
IB-1020	LINKE SEITE	1
IB-2010	RECHTE MITTEL SEITE	1
IB-401	DECKENBODEN RECHTS UND LINKS	2
IB-403	MITTELBODEN RECHTS UND LINKS	2
IB-405	SOCKELBODEN RECHTS UND LINKS	2
IB-501	EINLEGERBODEN	2
IB-611	SPIEGELTÜR	2
IB-6020	HOLZTÜR	2
IB-601	RÜCKWAND	2

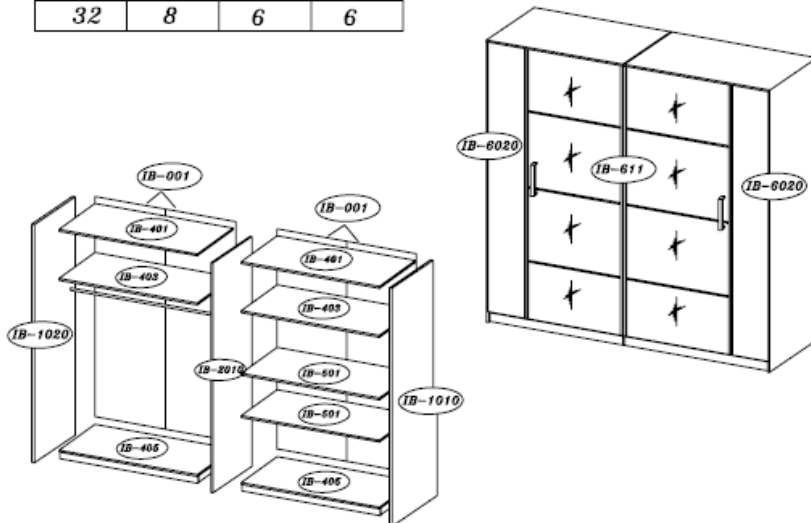

Hier können Sie die Schrauben zur besseren Identifizierung nachmessen (alle Maßangaben in mm).



Bitte füllen Sie dieses Servicekarte sorgfältig aus, damit Sie alle nötigen Daten bei Ihrer Ersatzteilbestellung zur Hand haben. Die Telefonnummer der Bestellannahme finden Sie in Ihrem aktuellen Katalog.

Modellname
 Artikel - Nr.:
 Type
 Farb - Nr.:
 Kundennummer:
 Name:
 Strasse: Haus - Nr.:
 PLZ Ort:
 Rechnungsdatum:

Tel. für Rückfragen:
 Grund der Ersatzteilanforderung:

Benötigte Teile:

Teile - Nr.	Bezeichnung	Anzahl