

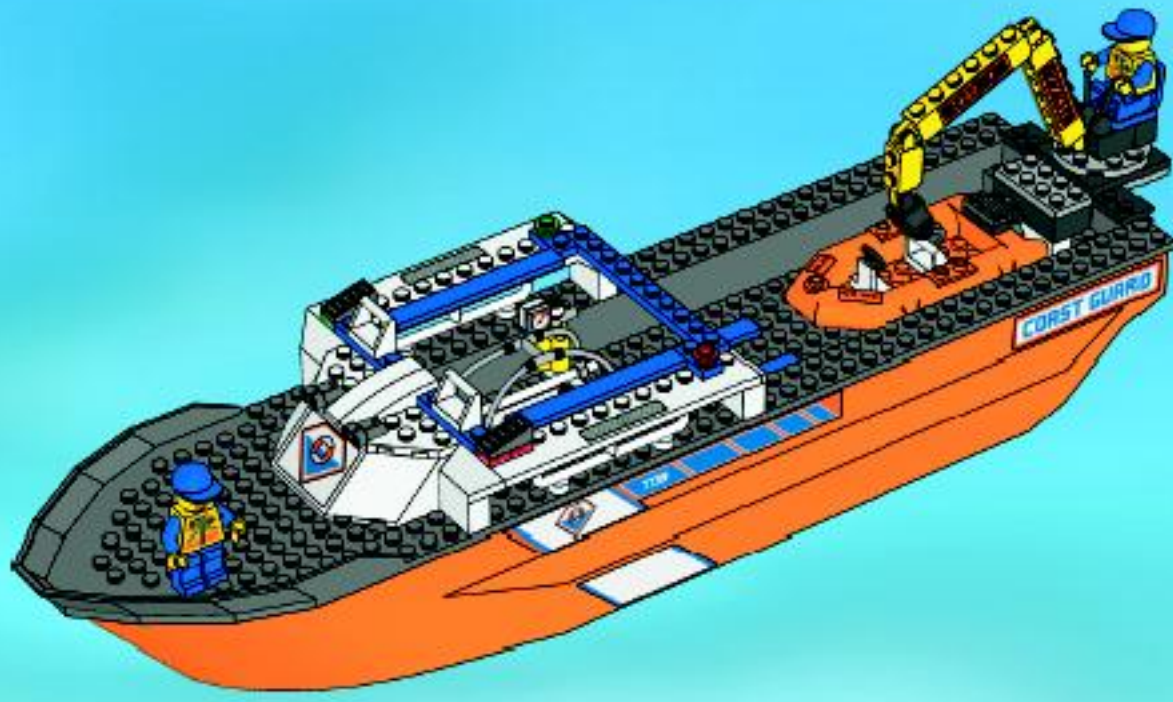

CITY

7739





1

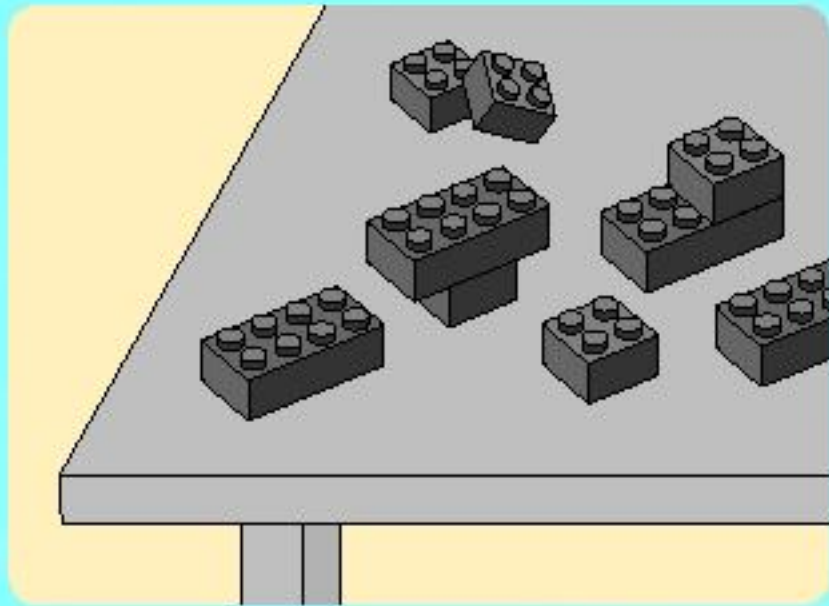

2

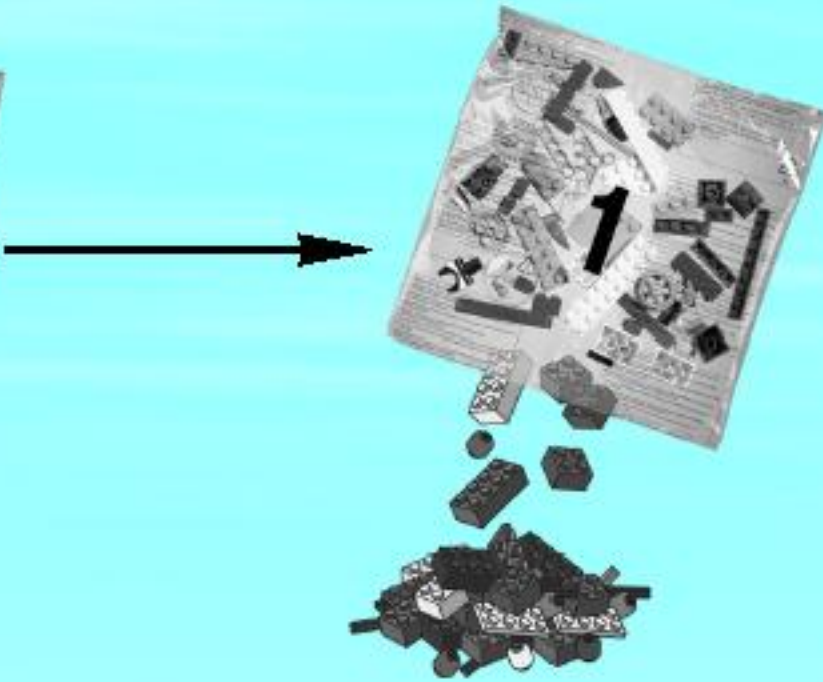

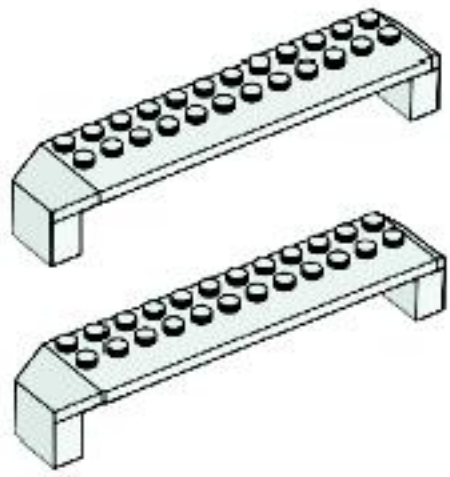

+

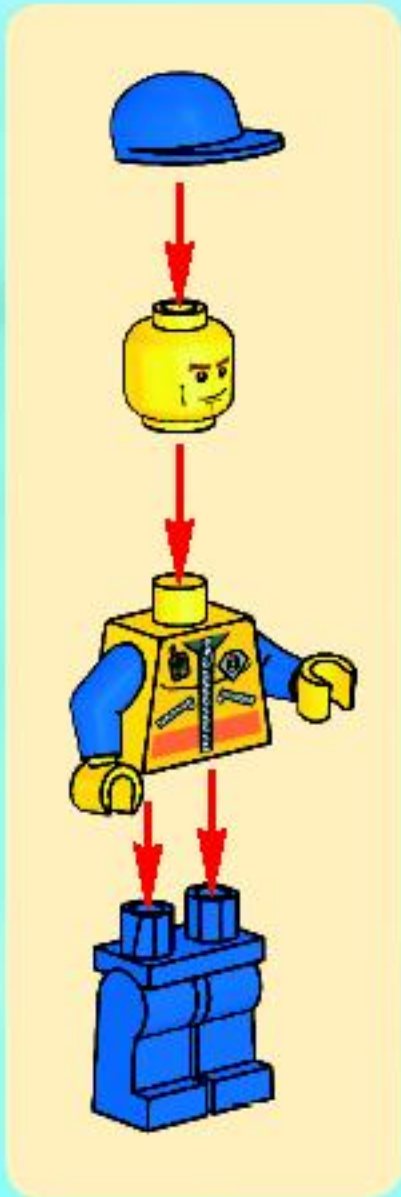
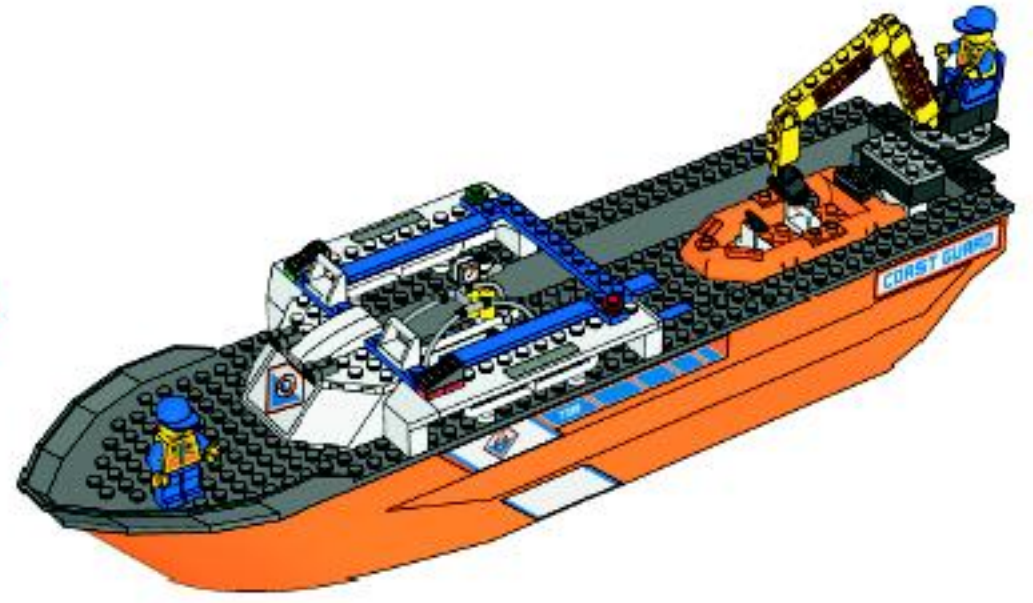

1

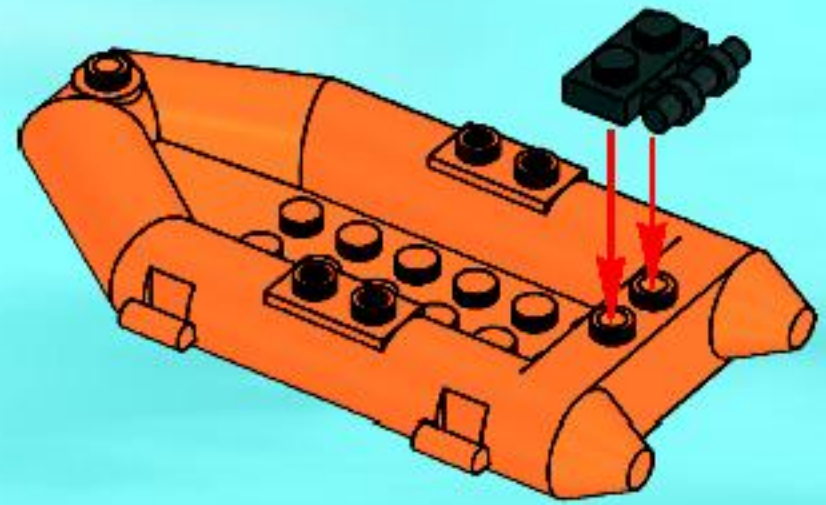

2

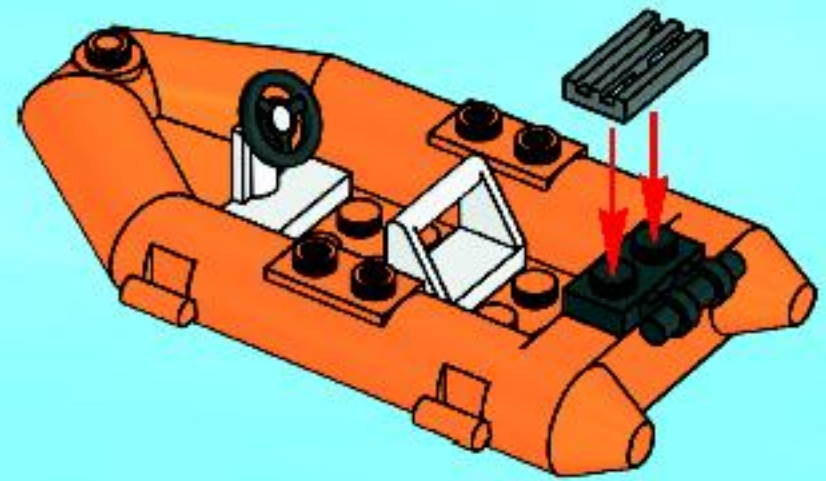

3

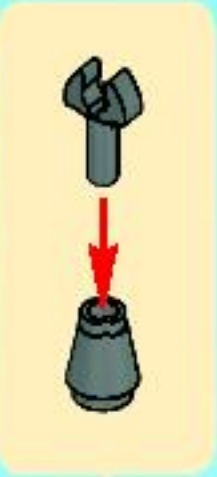
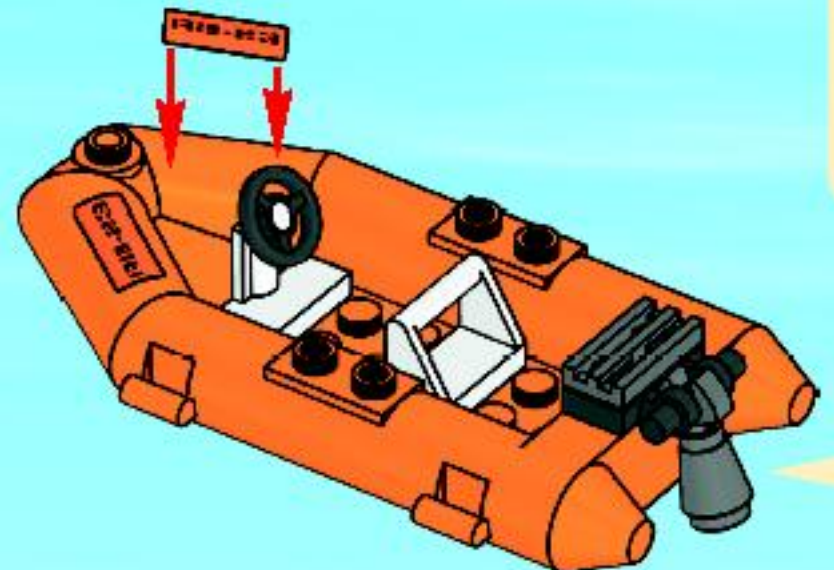

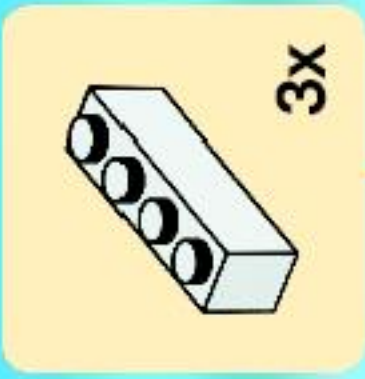

**1**

2

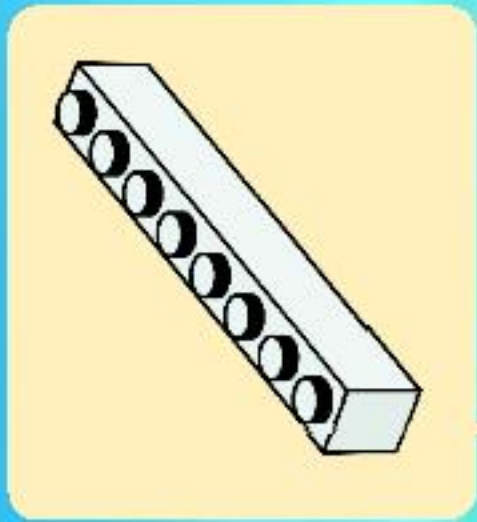

3

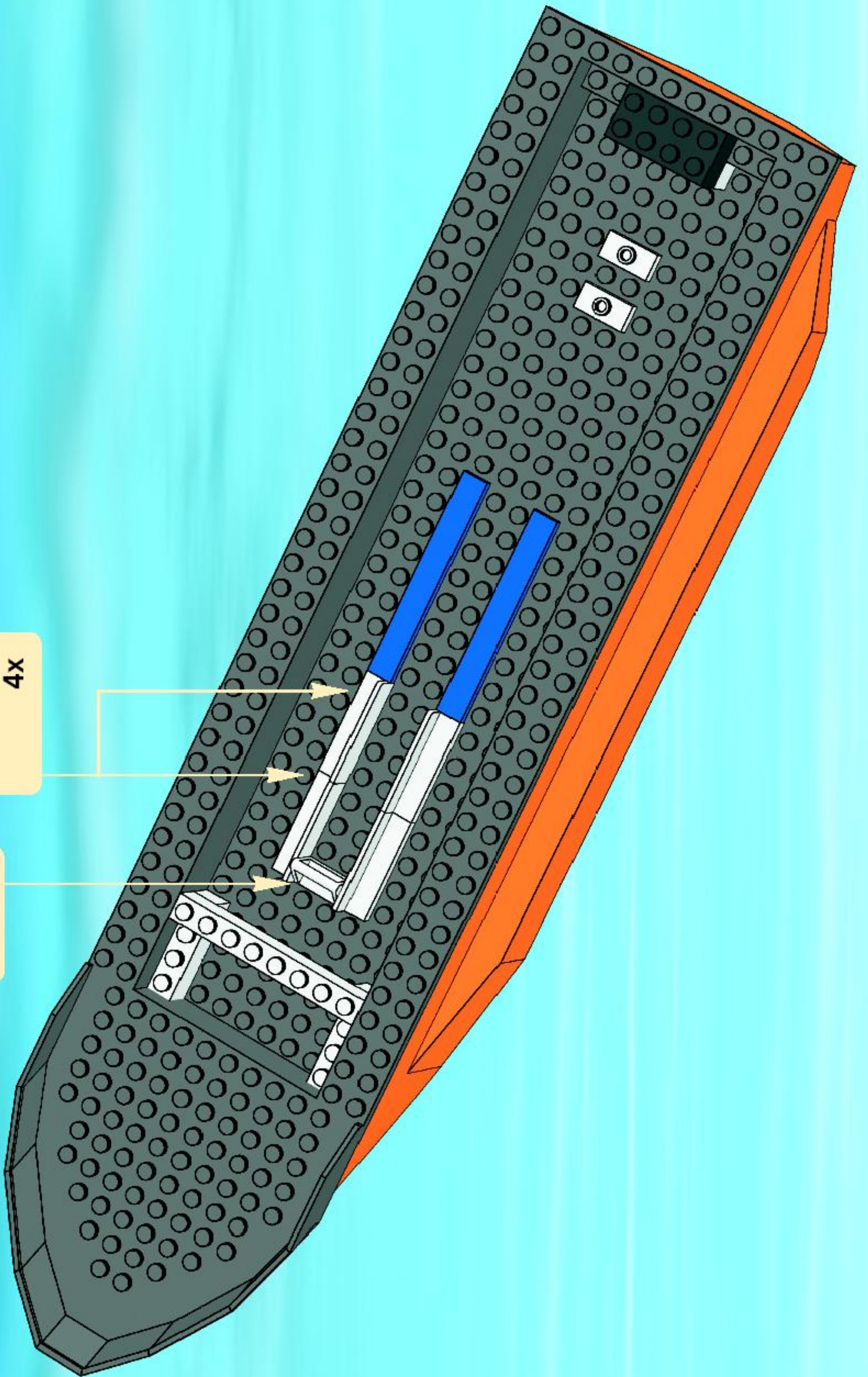
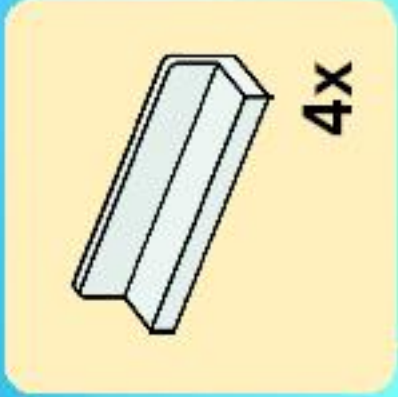

4

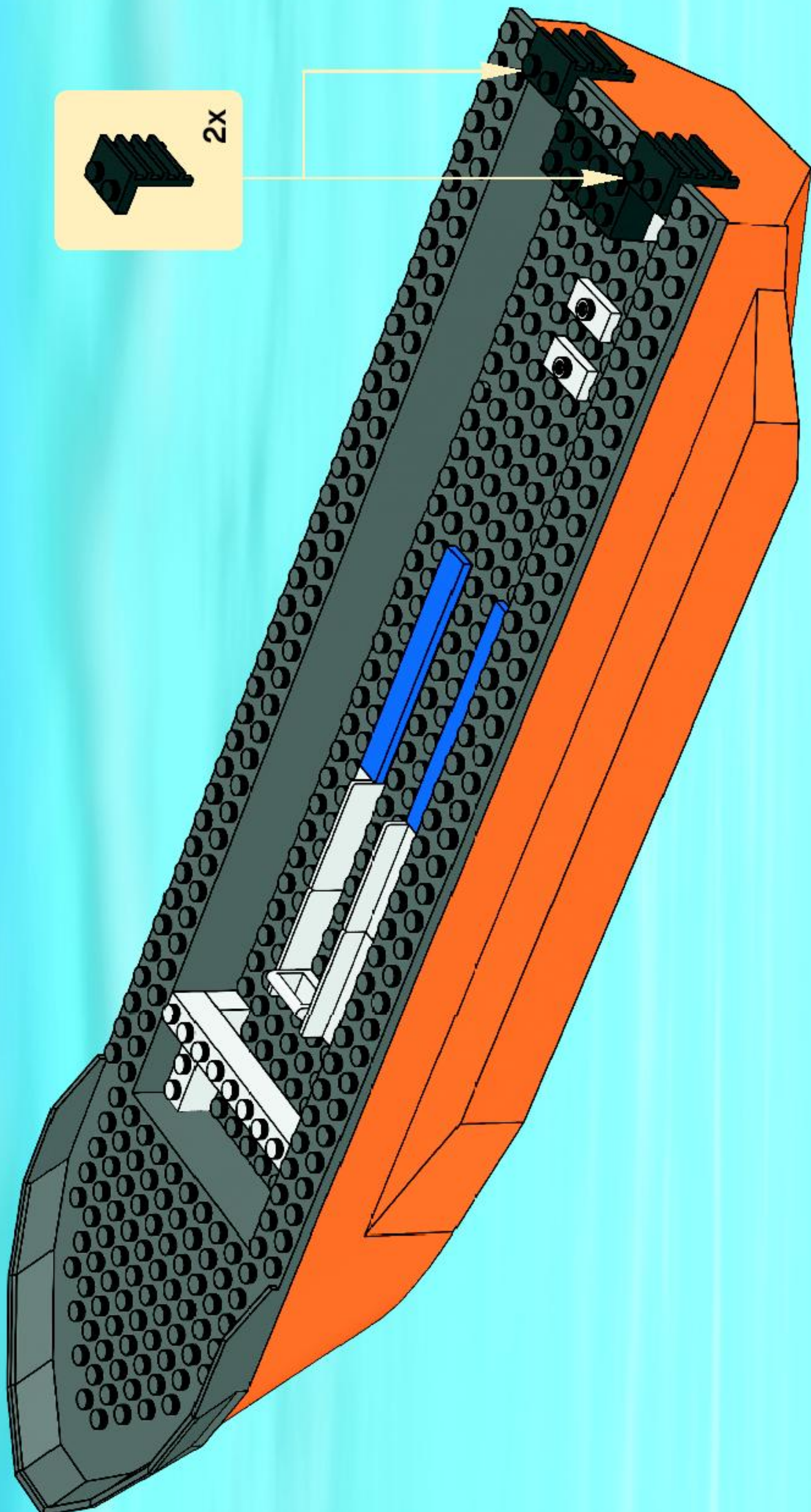

1



2

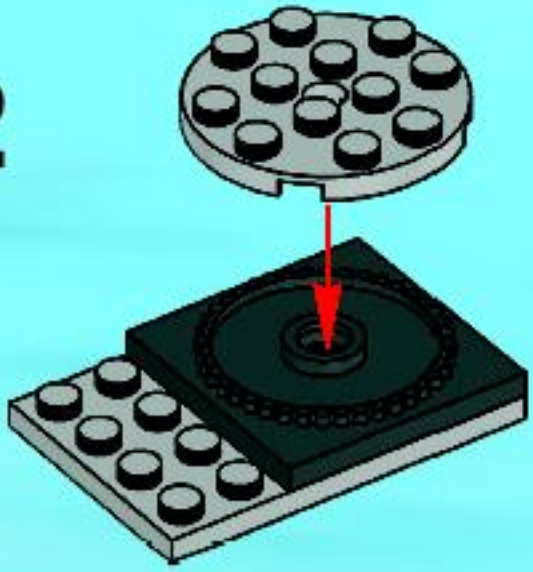

3

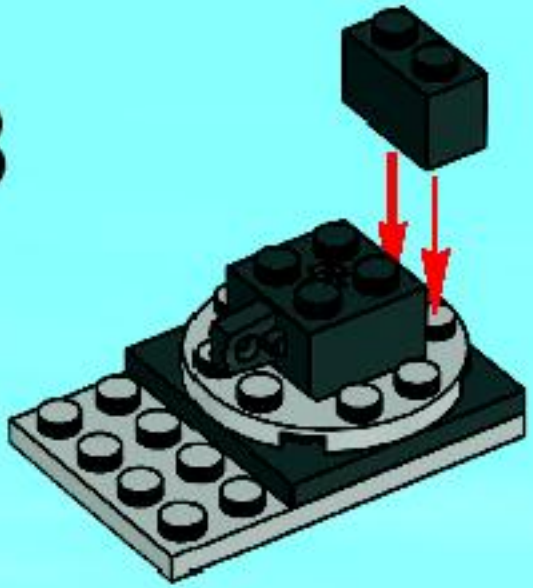

4

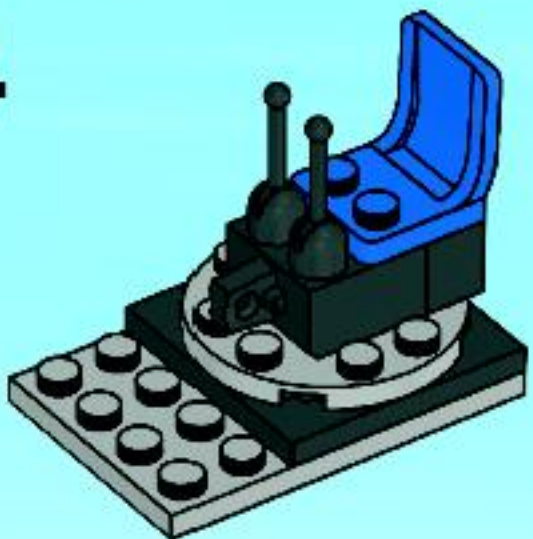

1

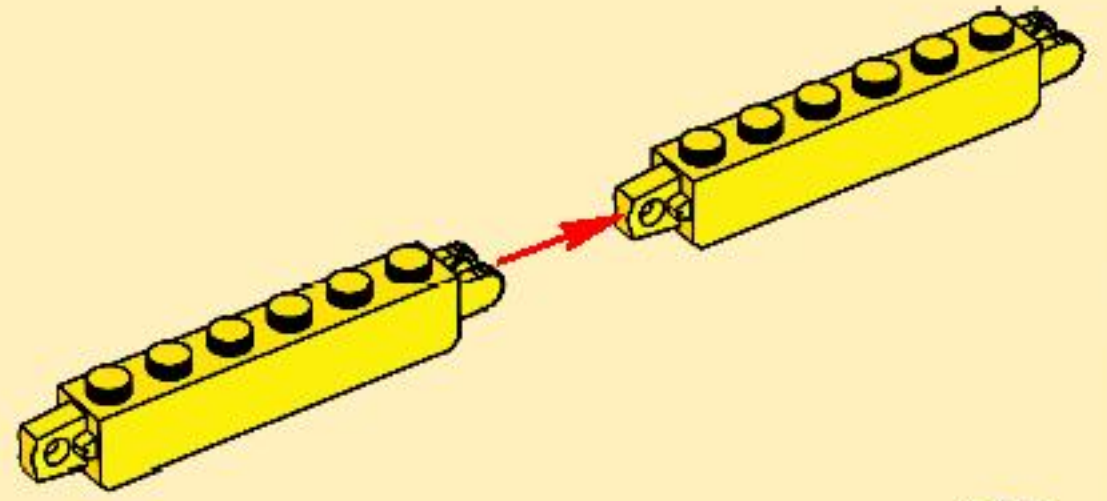

2

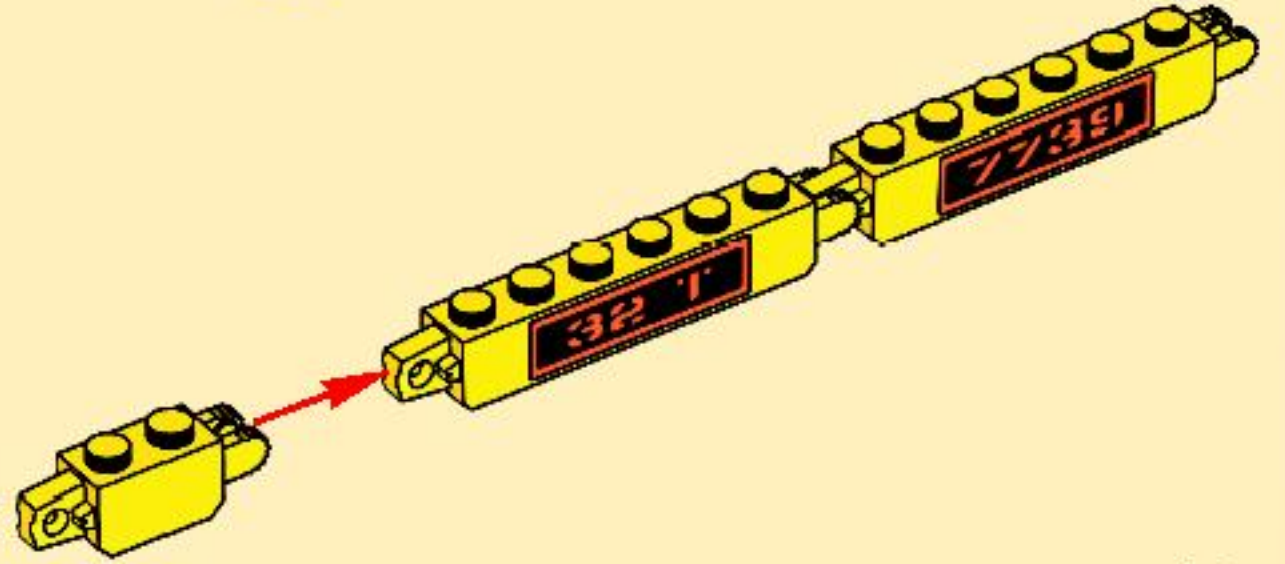

3

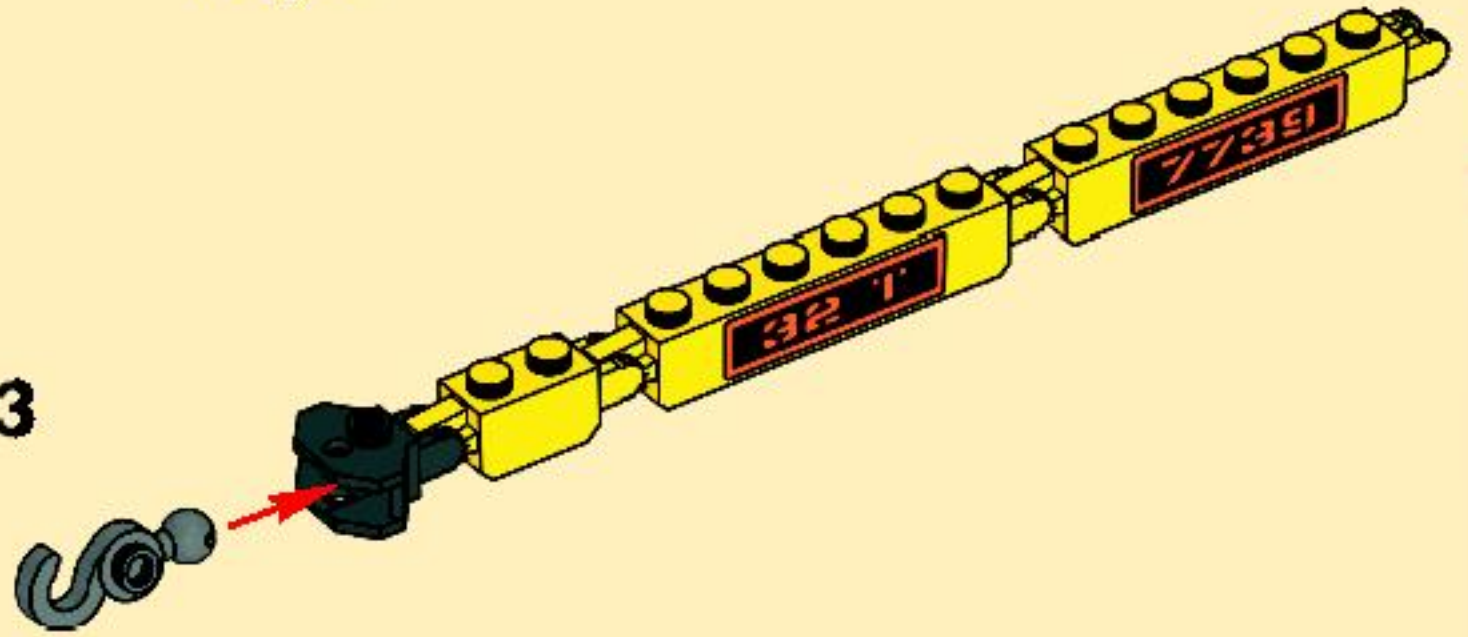



5

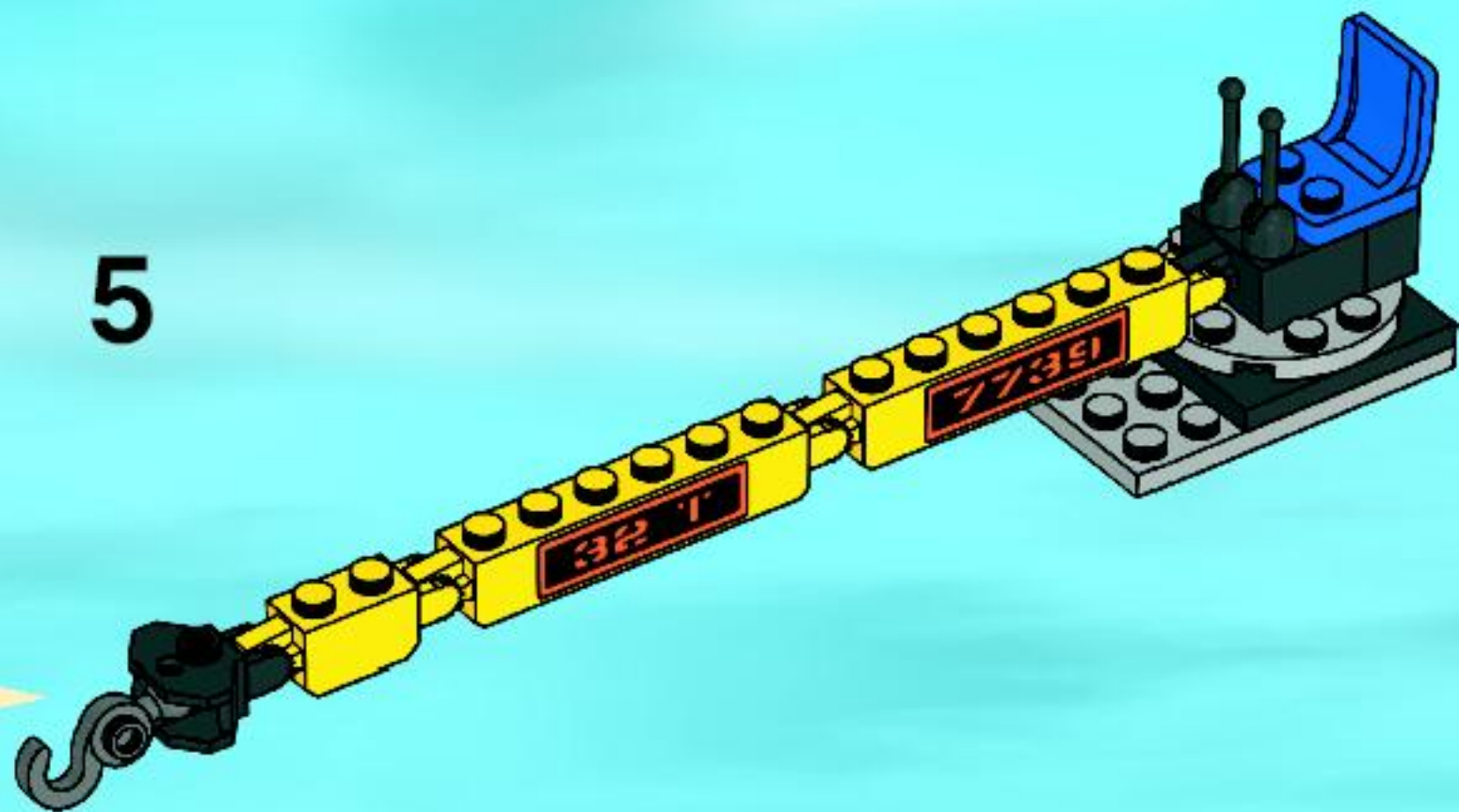

5

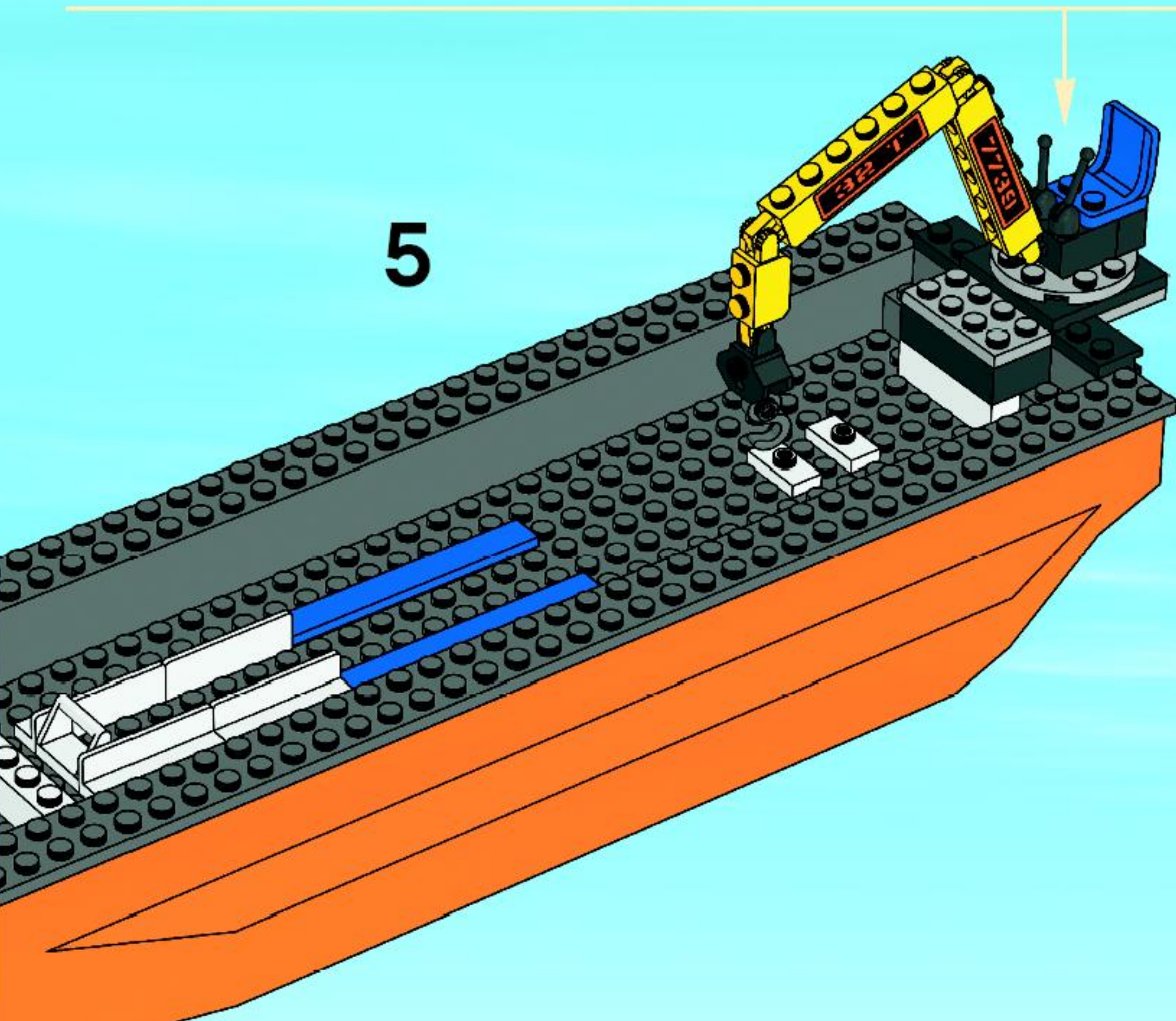

6

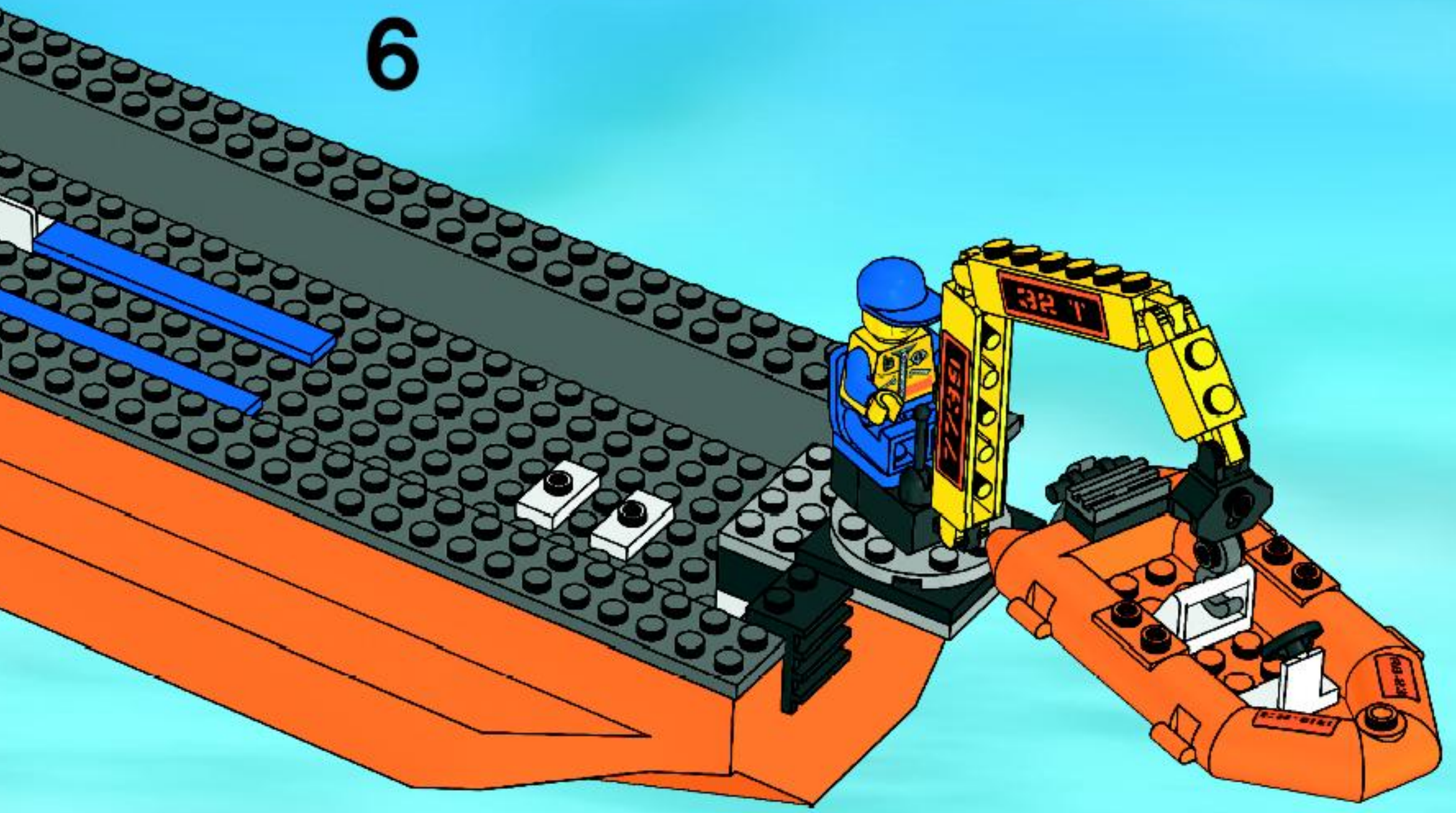

7

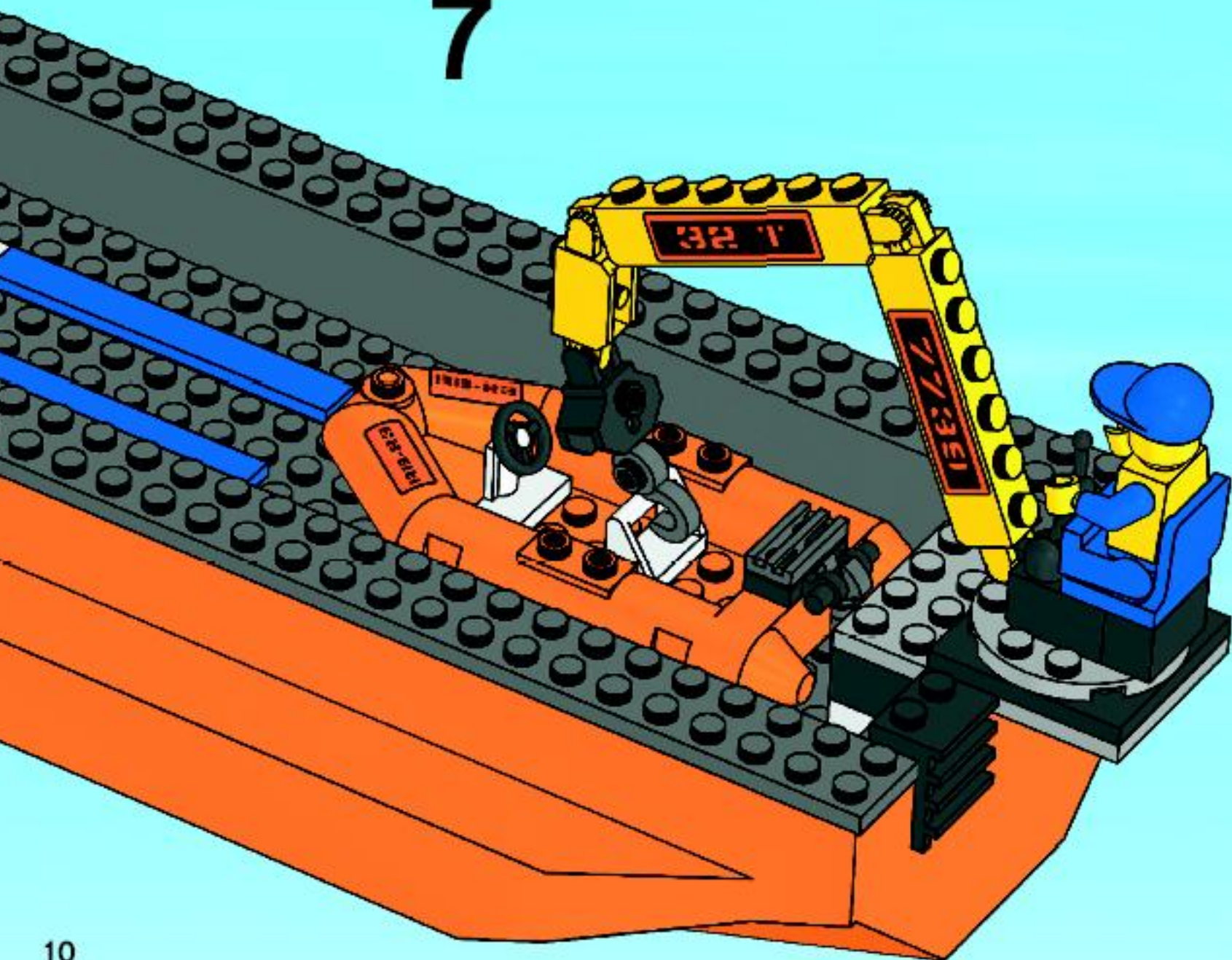

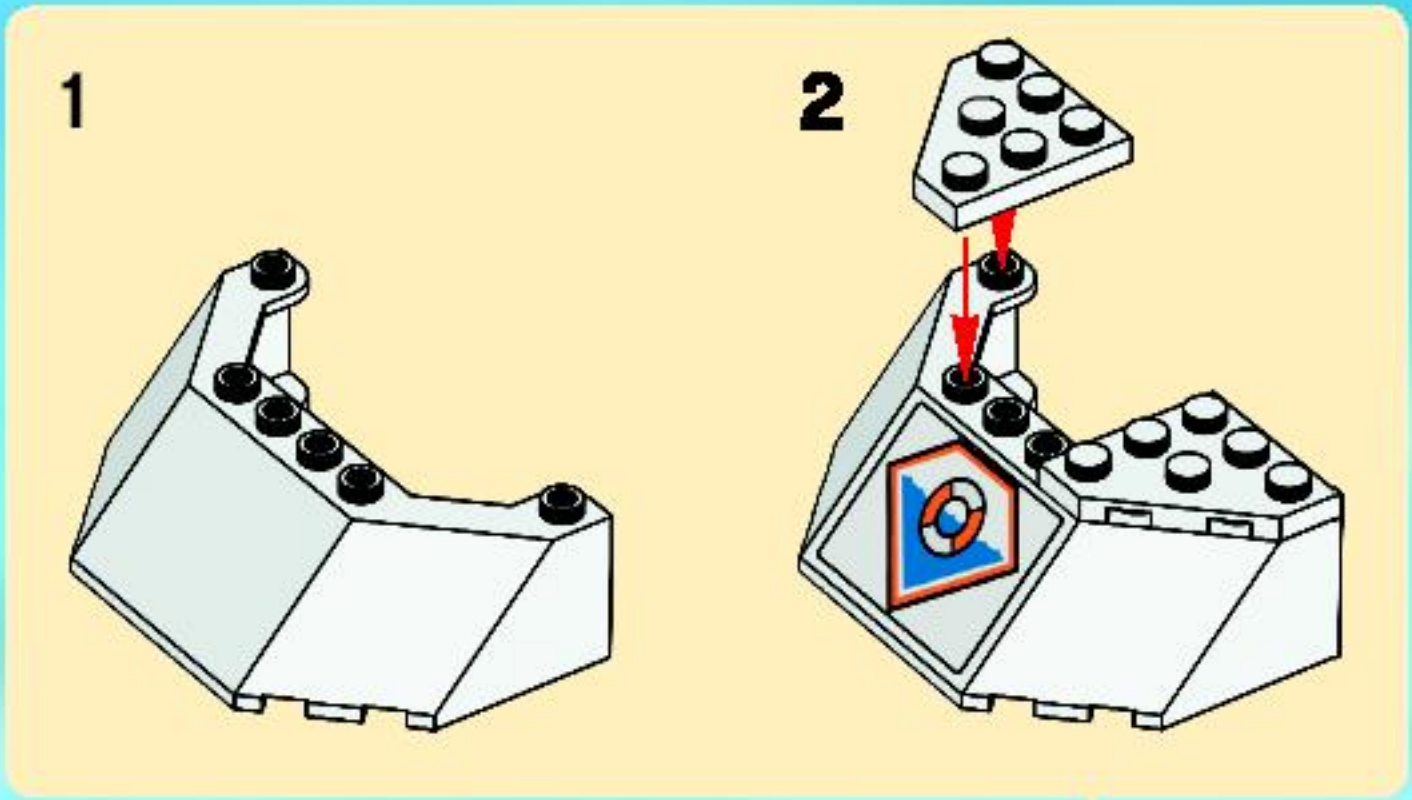

8

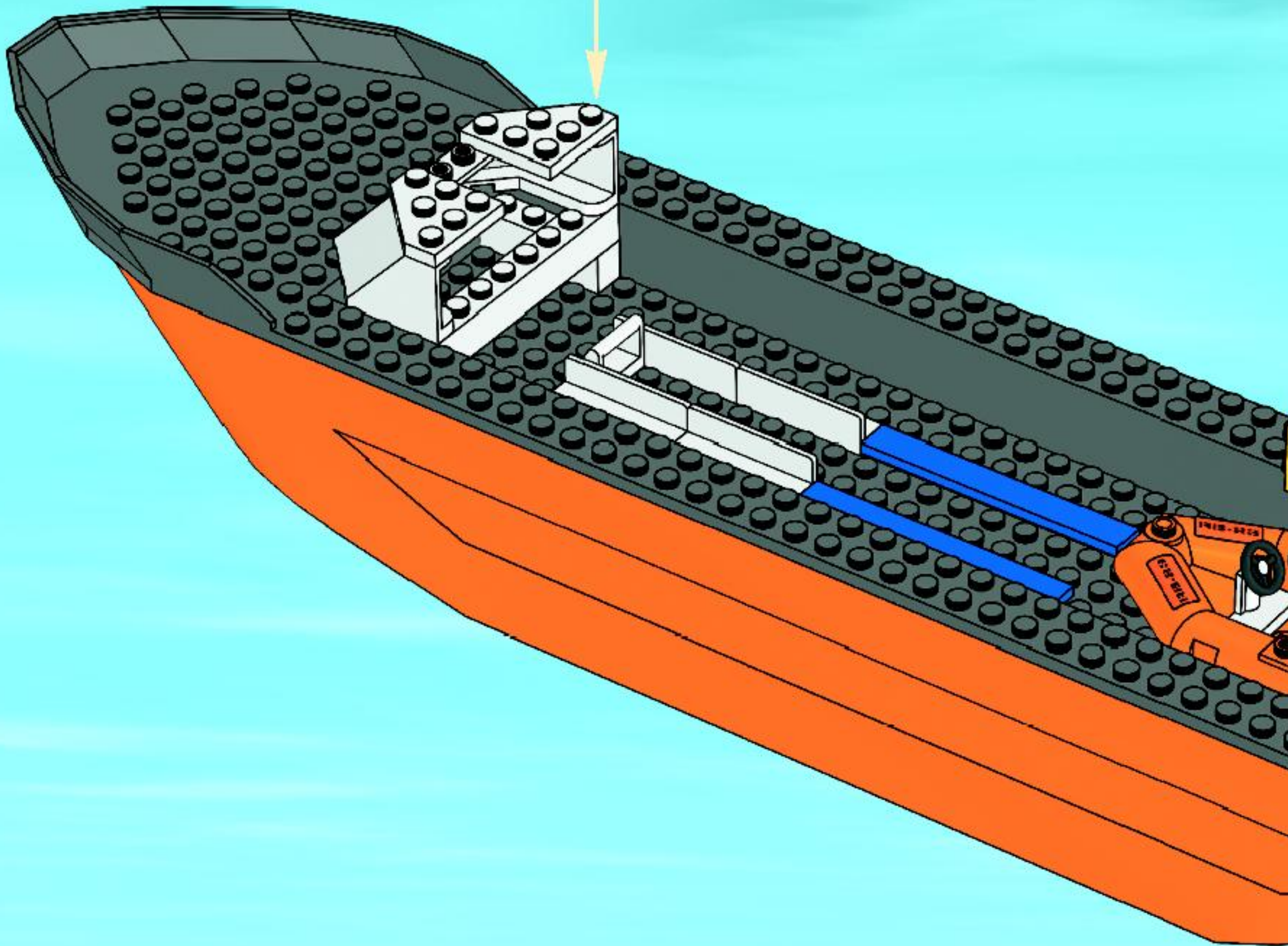

1

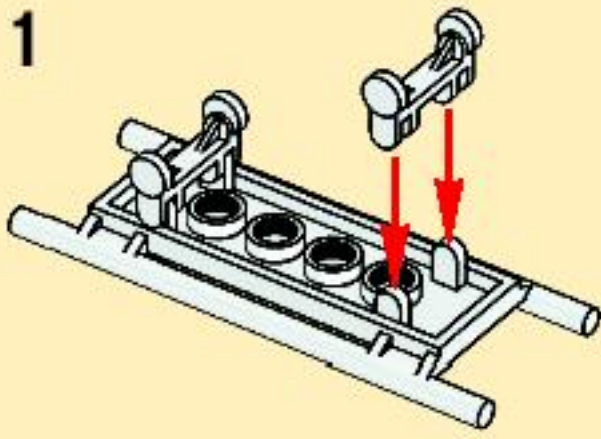

2

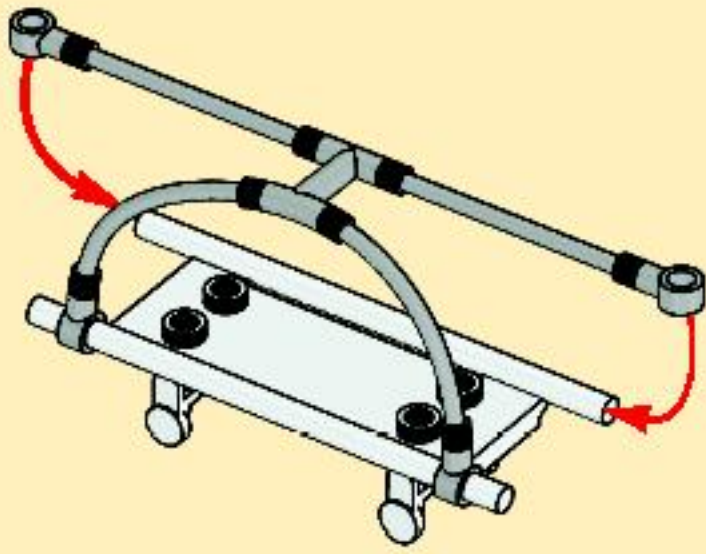

3

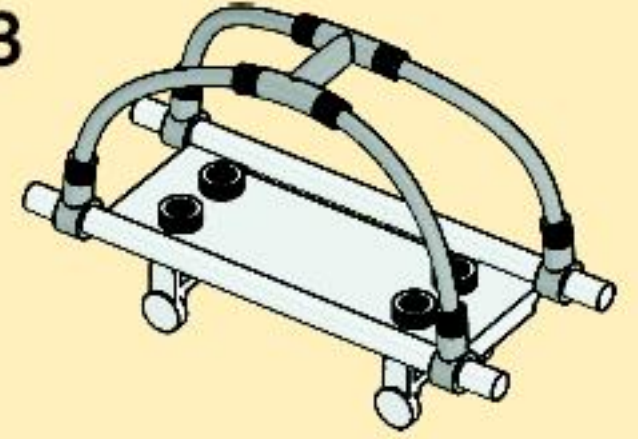

9

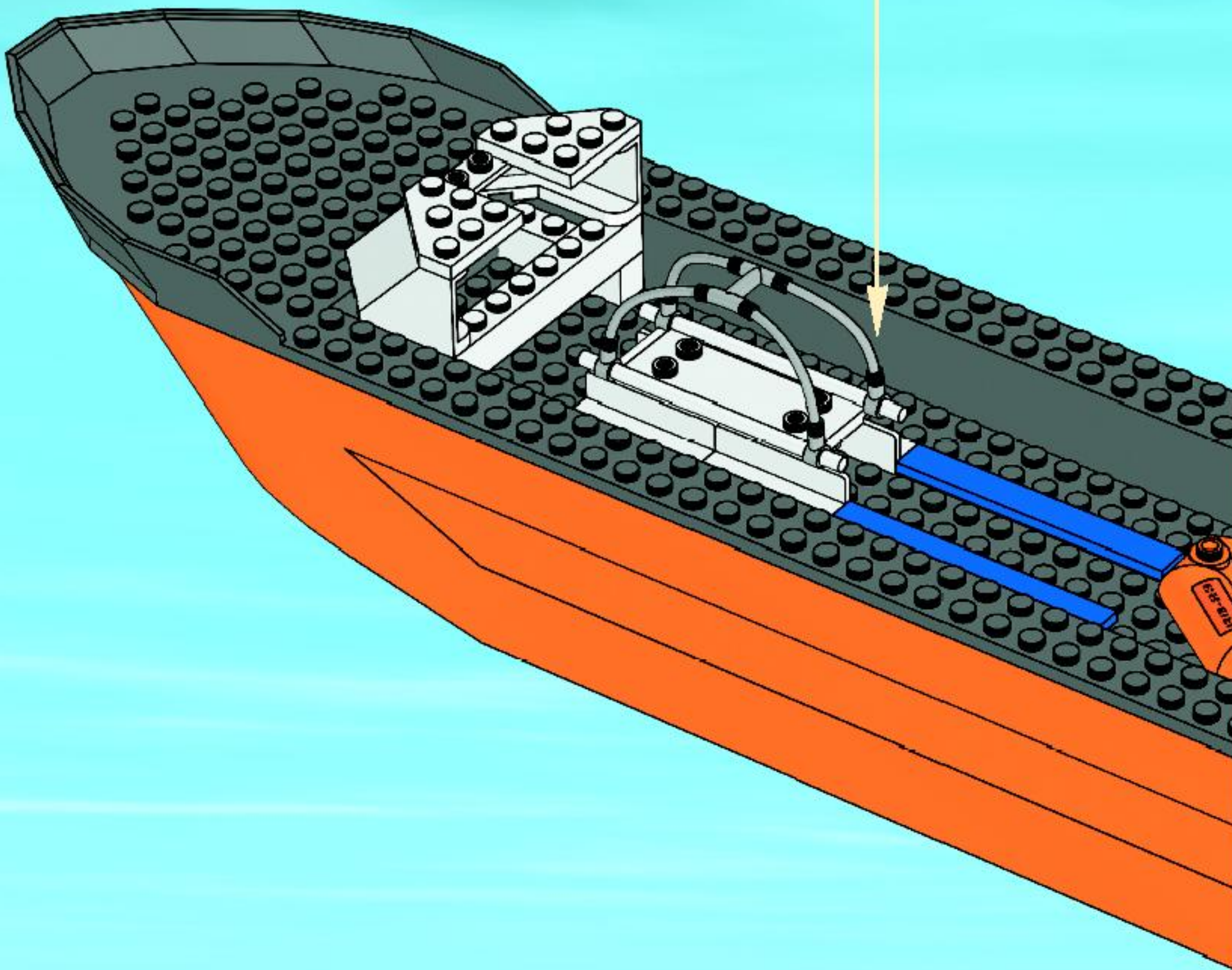

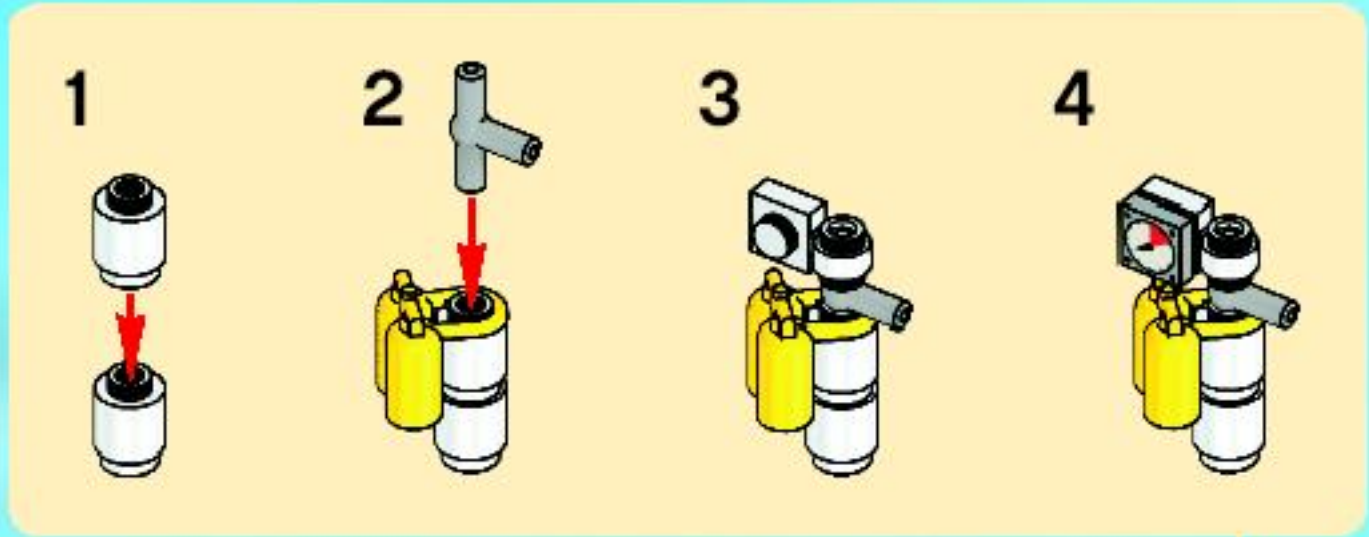

10

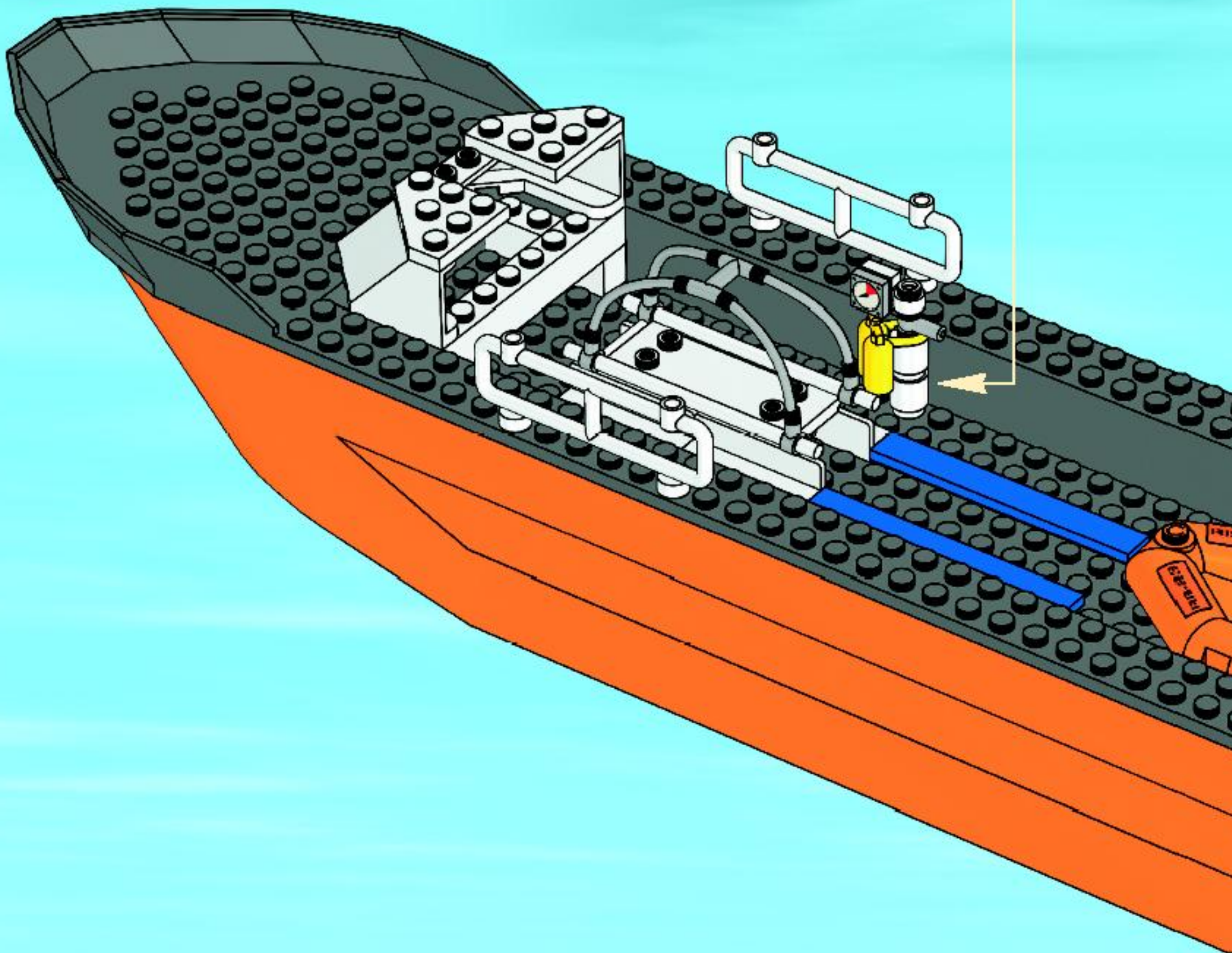

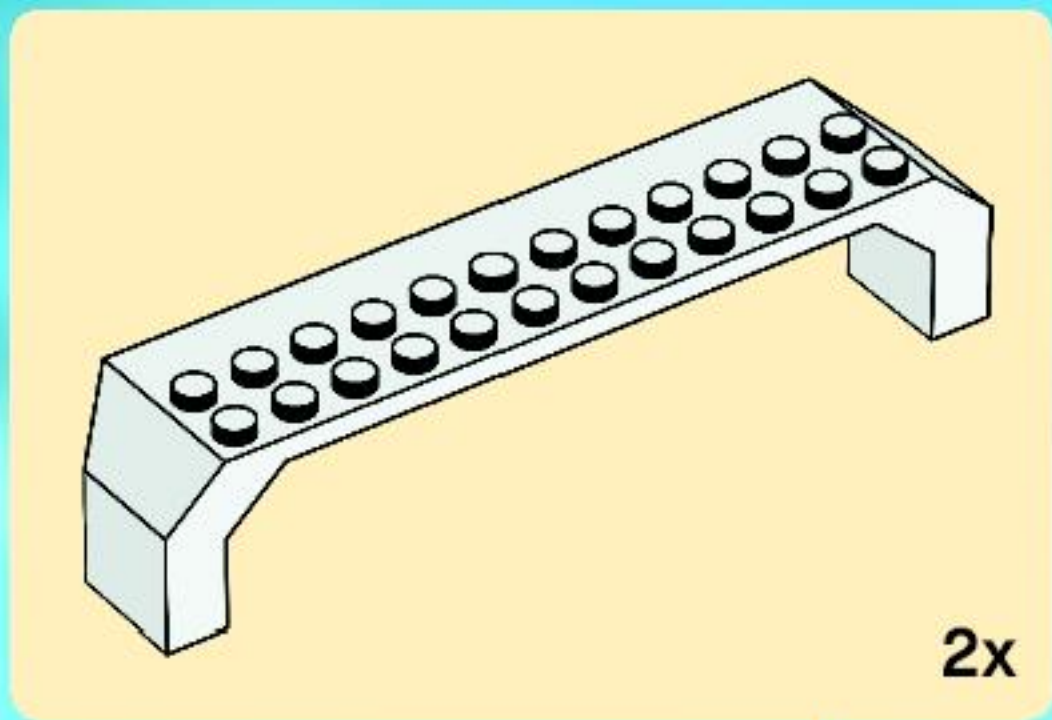

11

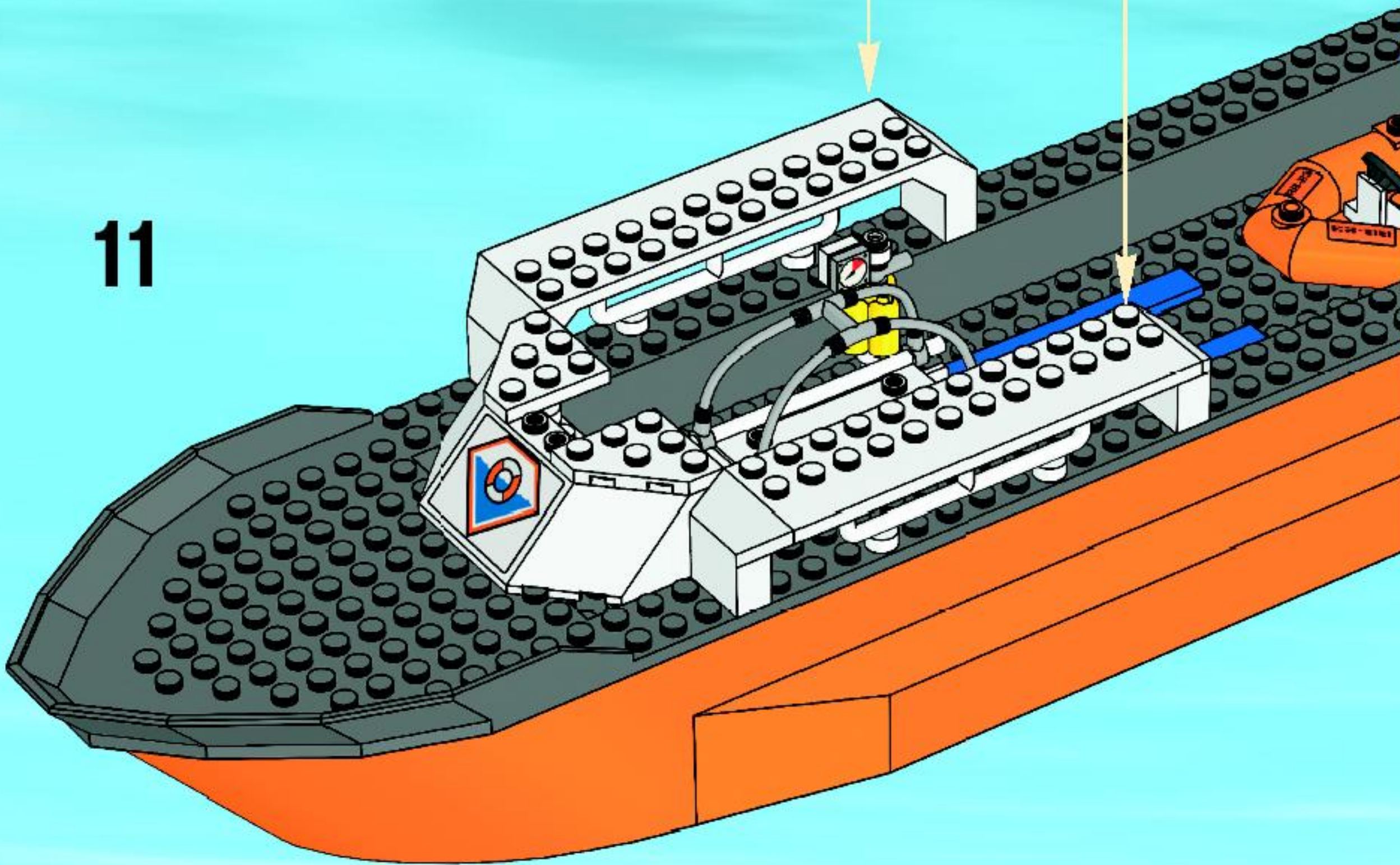

12

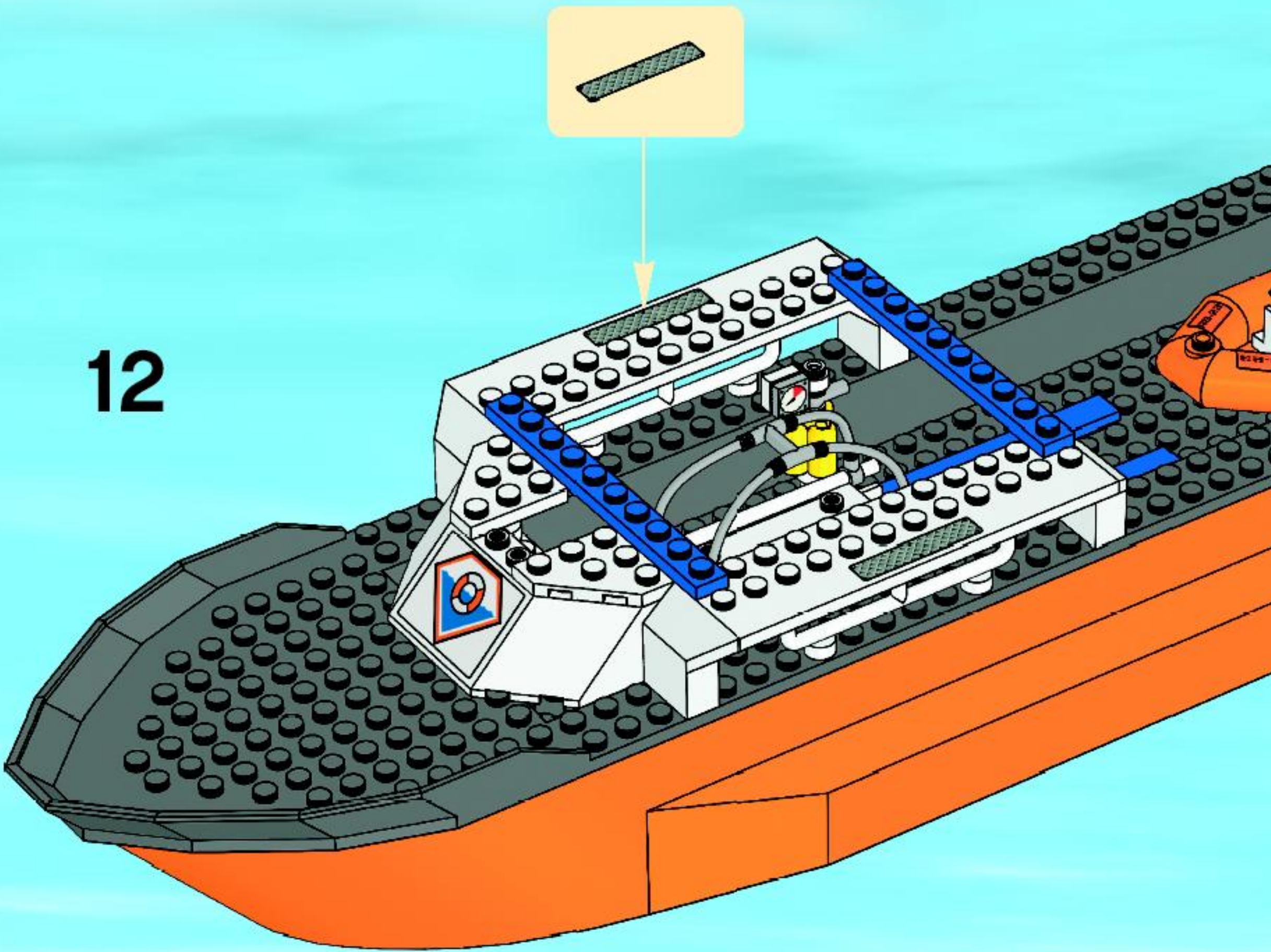

13

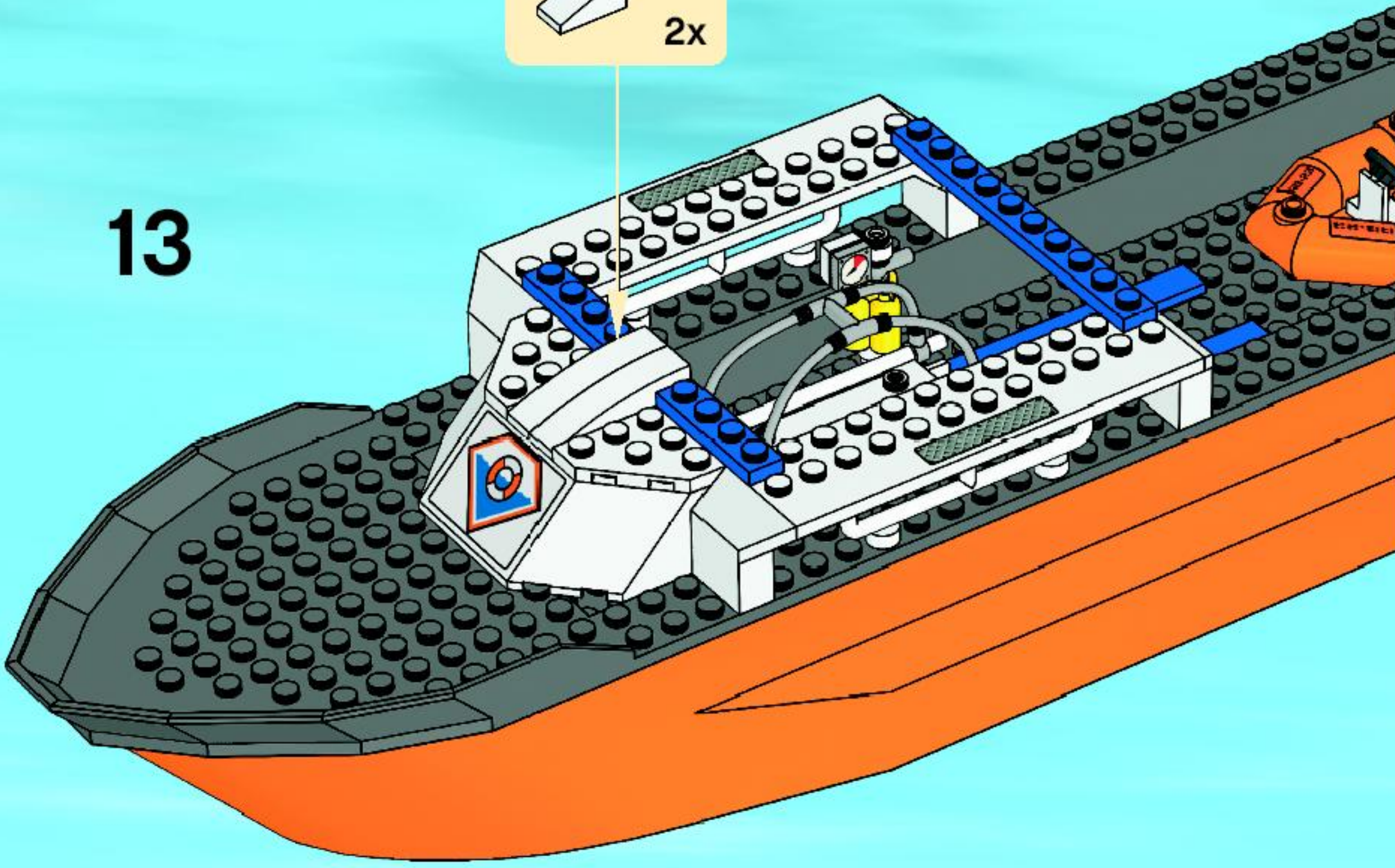
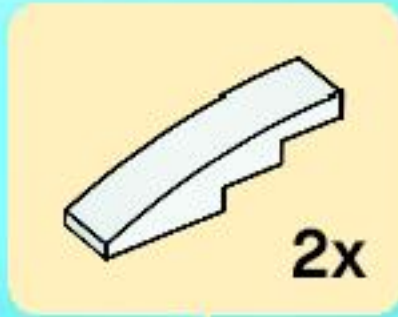



14

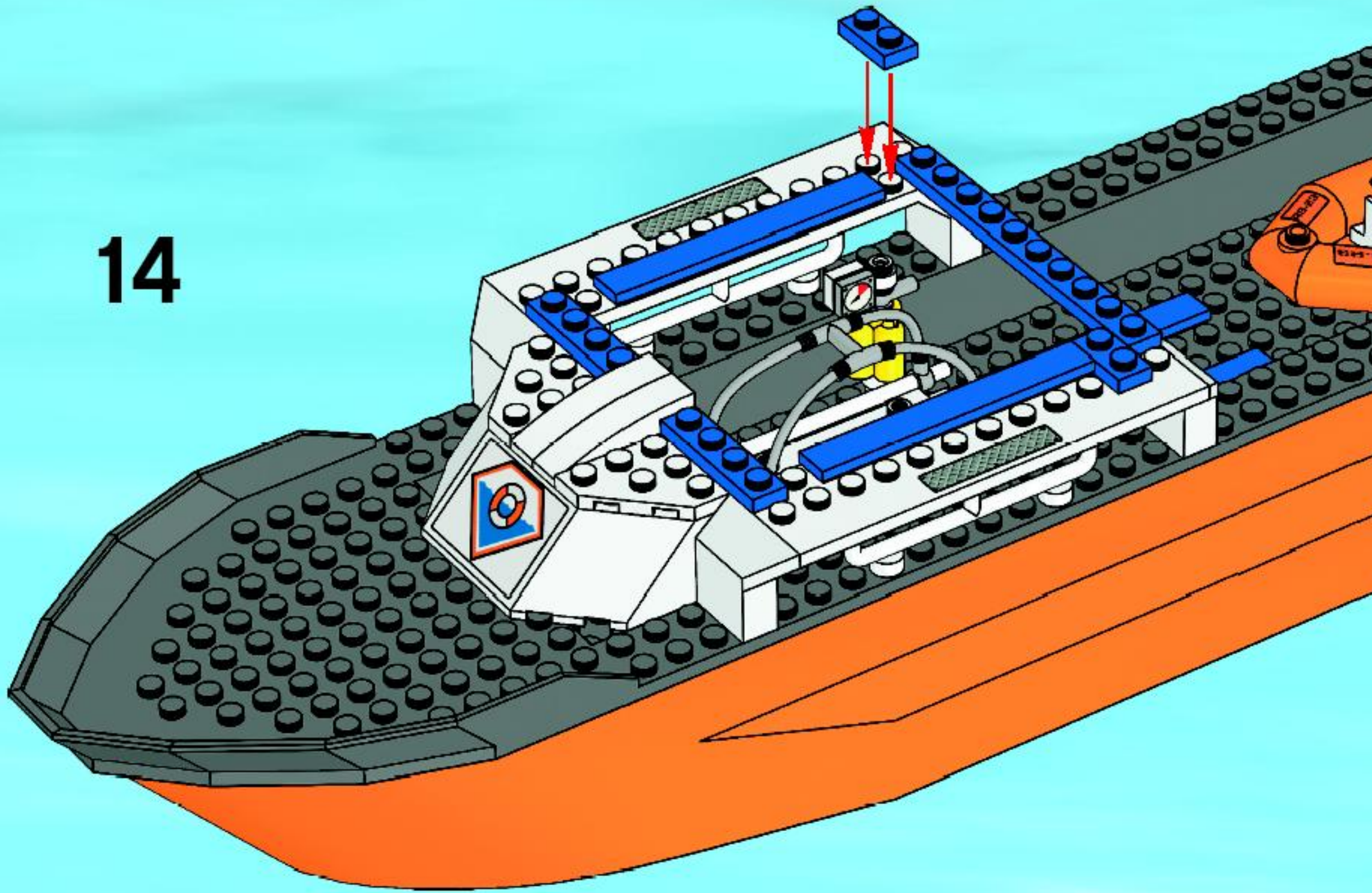

15

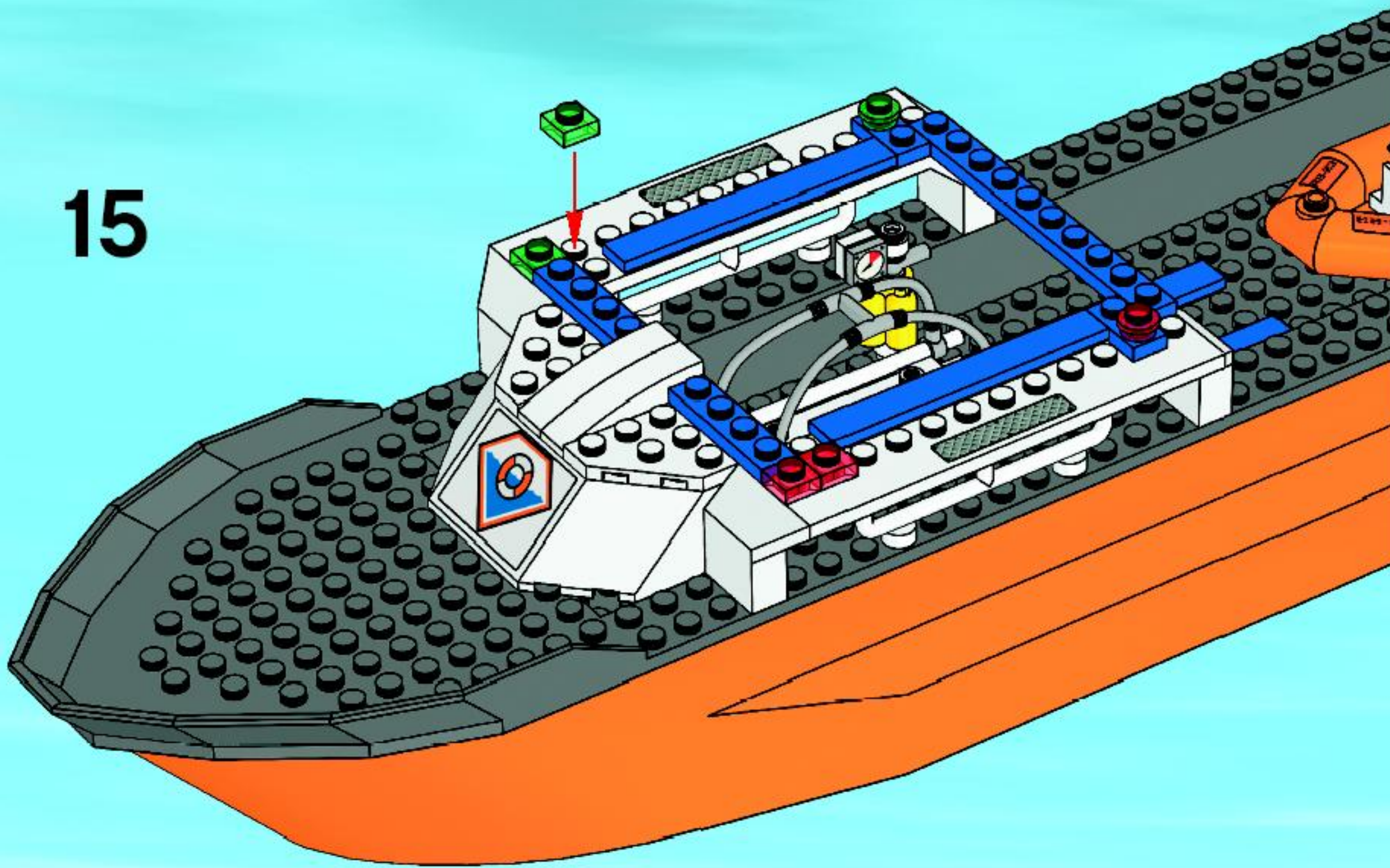

16

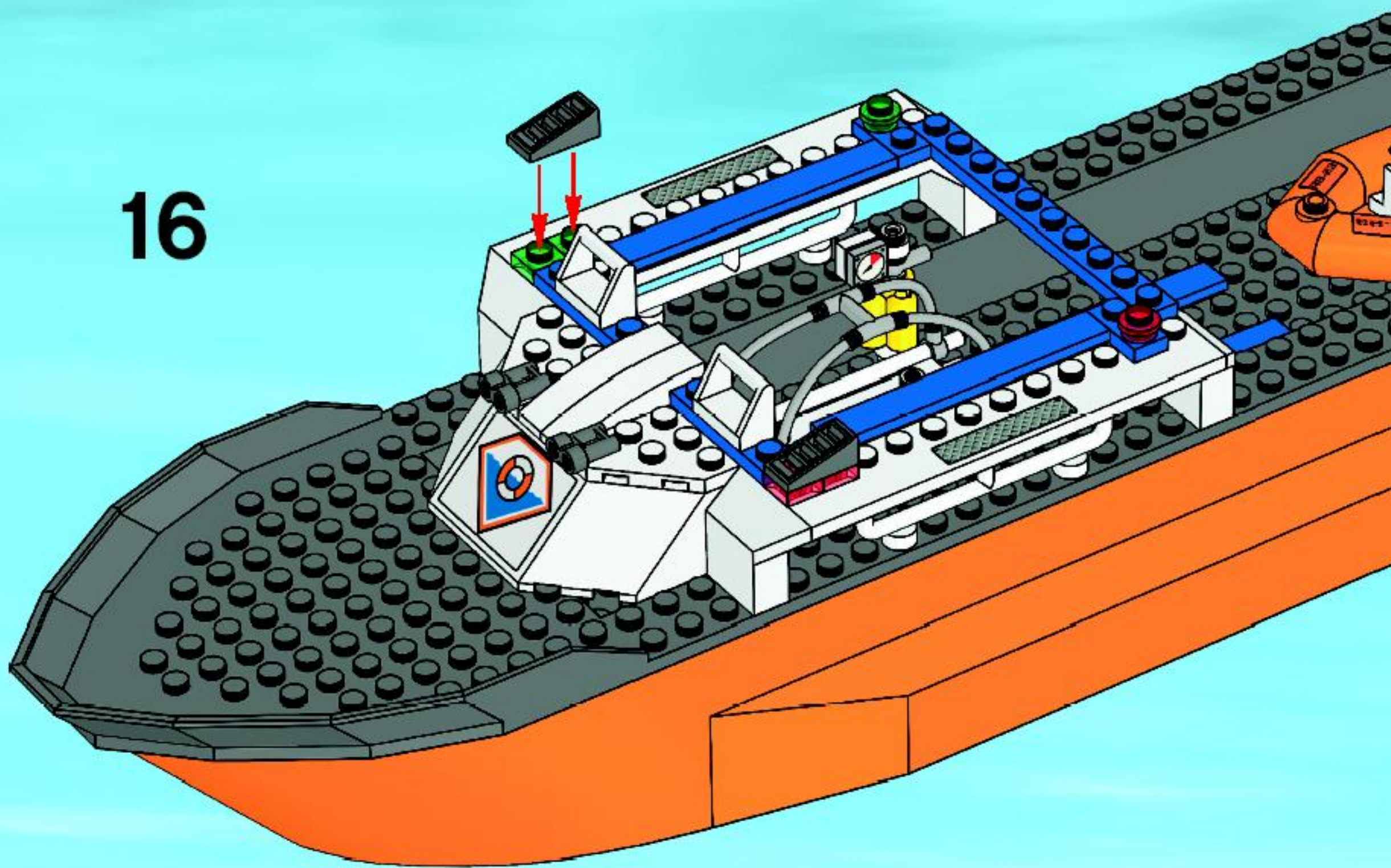



1

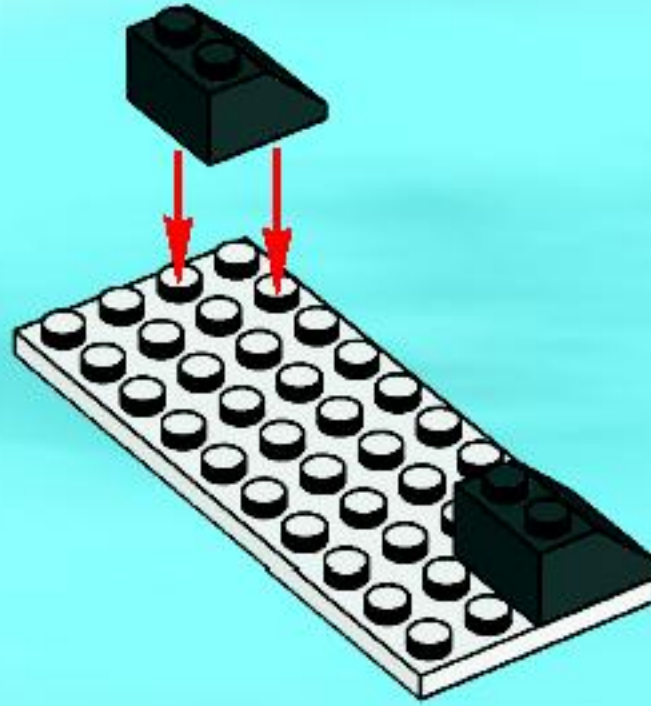

2

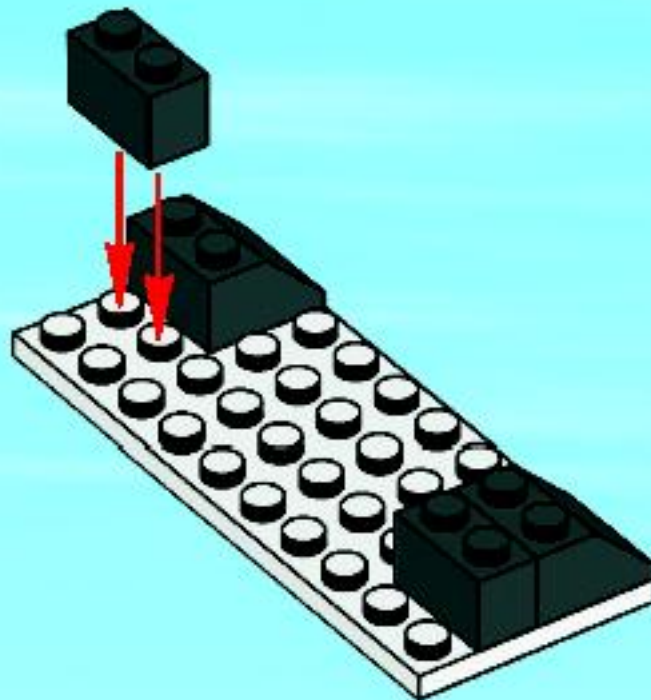

3

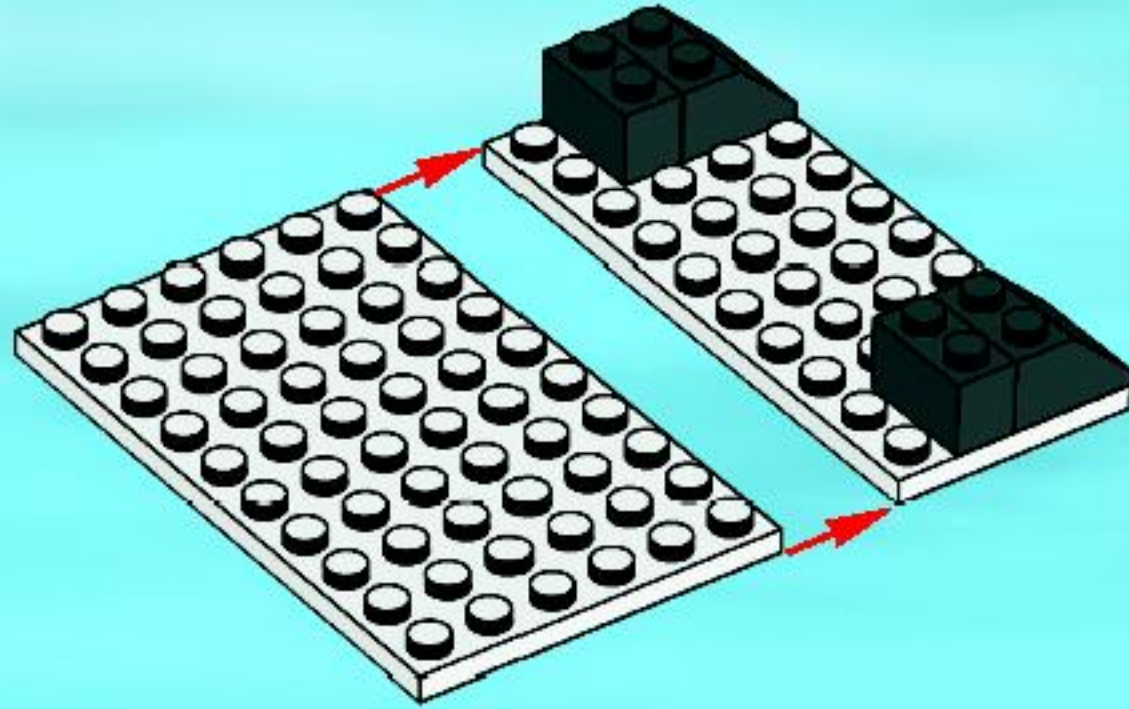

4

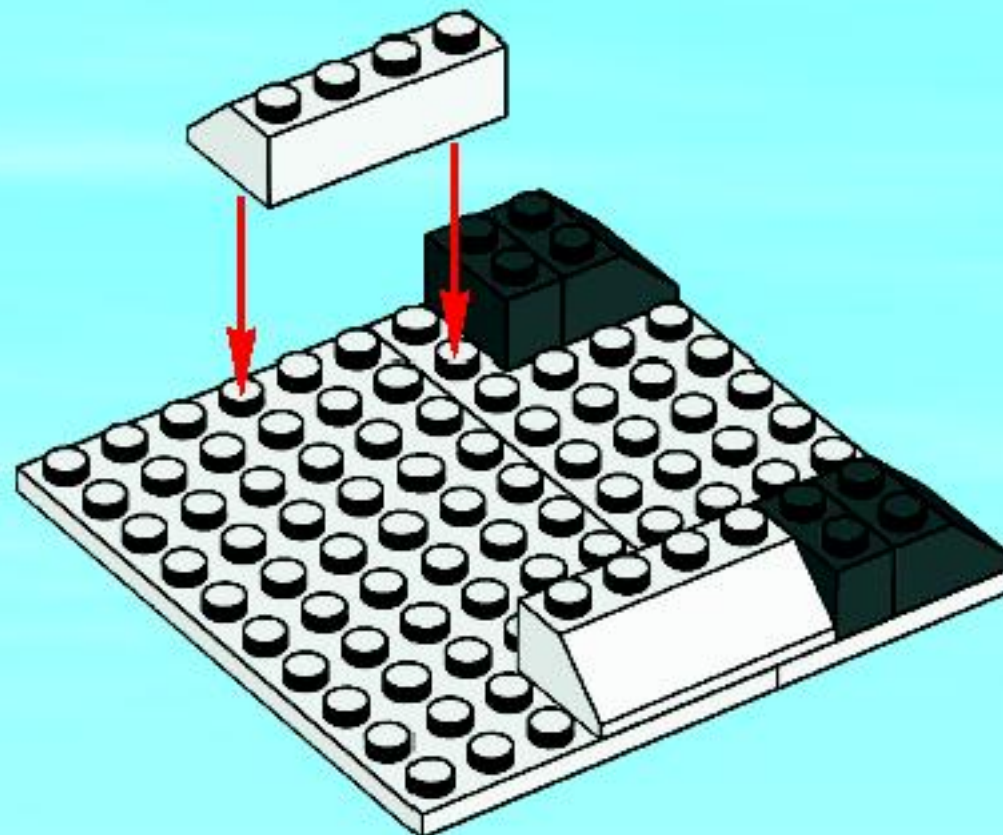

5

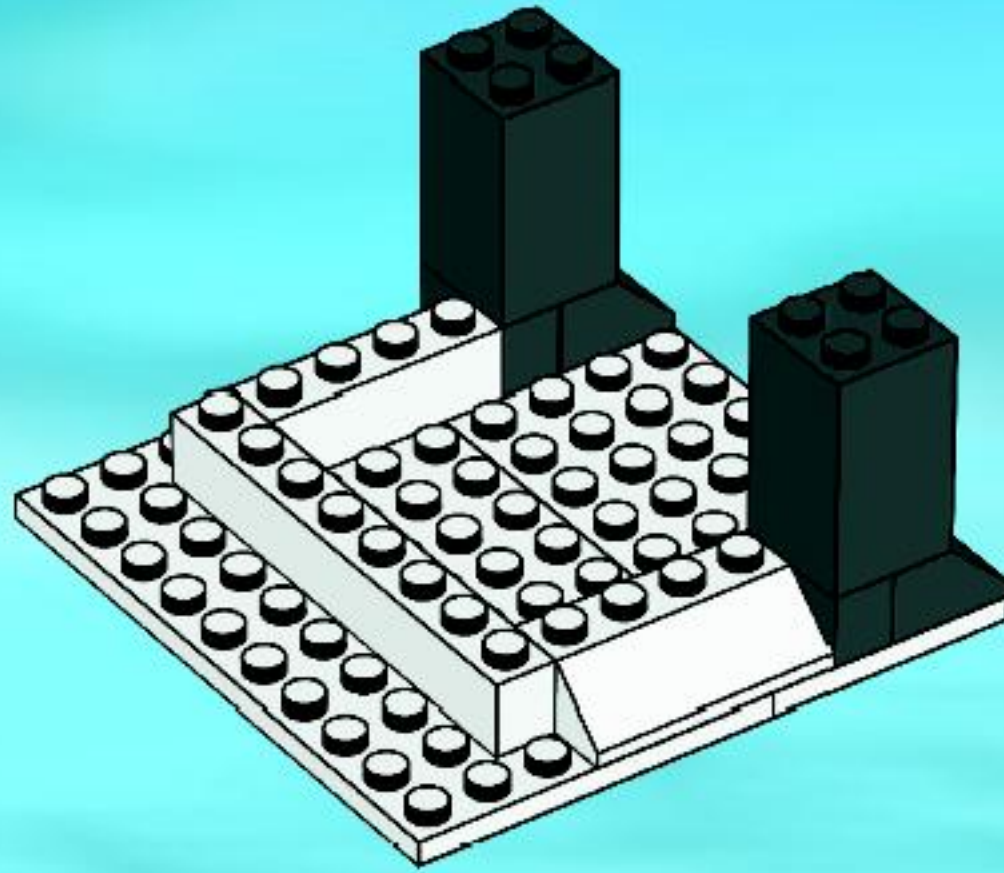

6

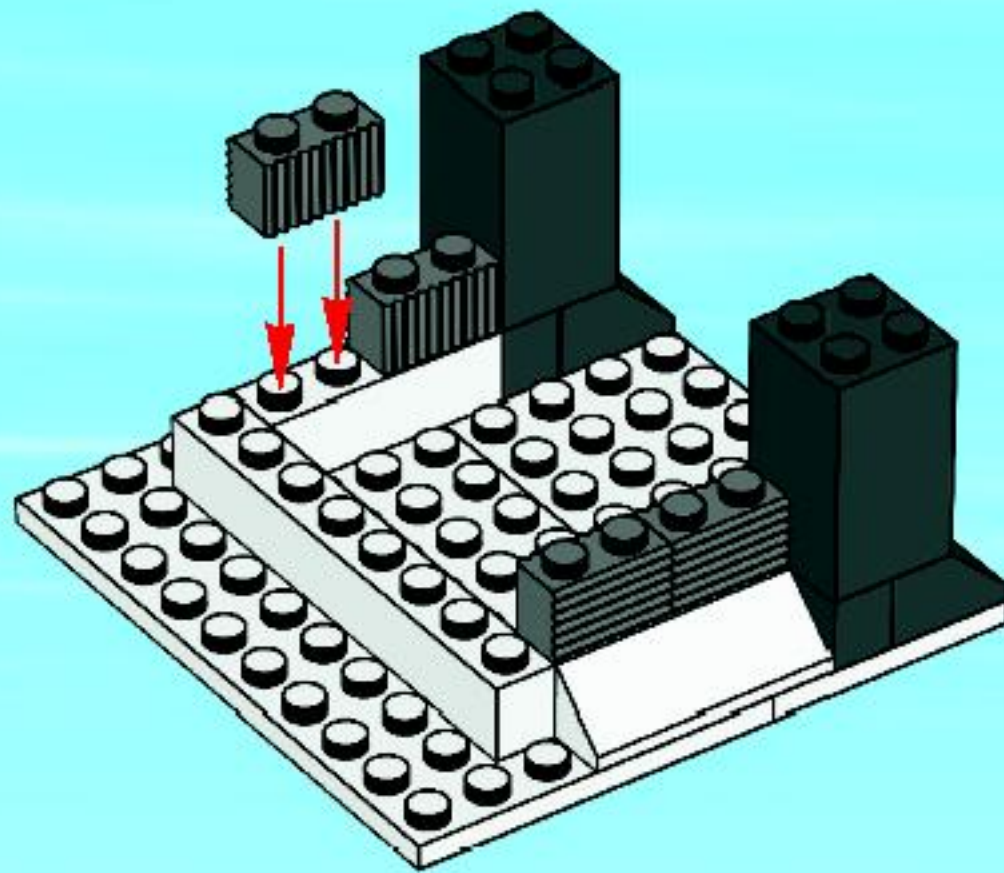

7

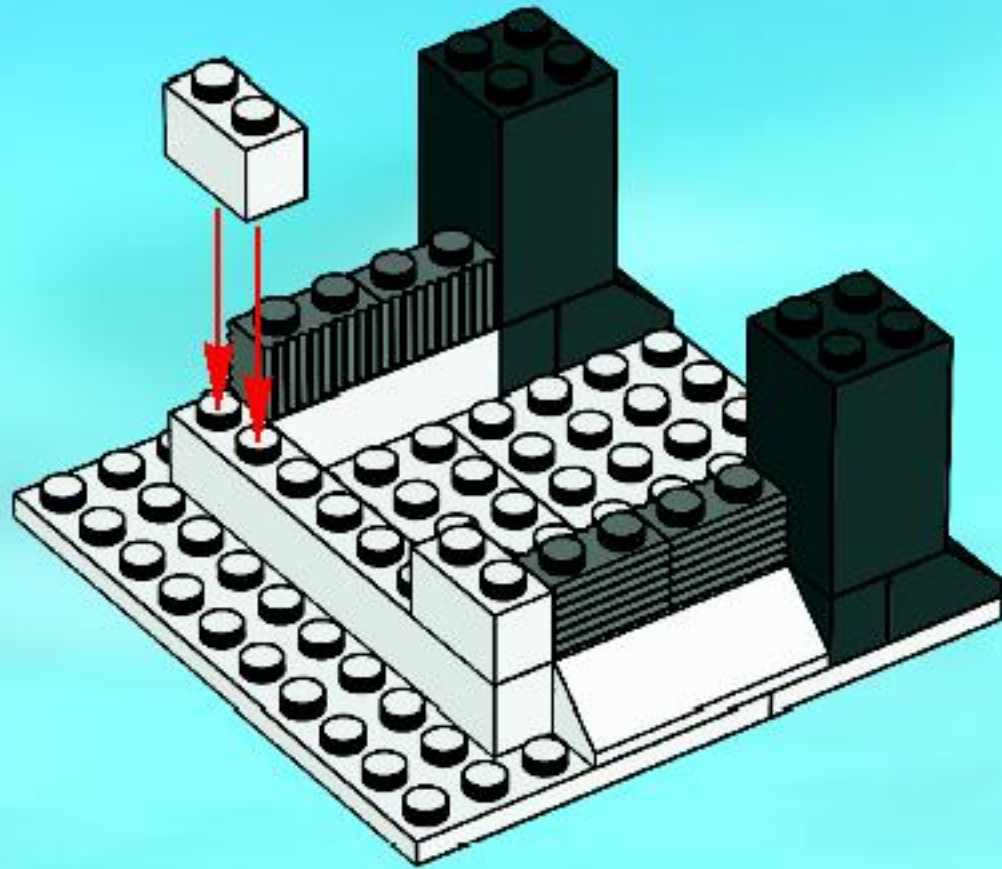

8

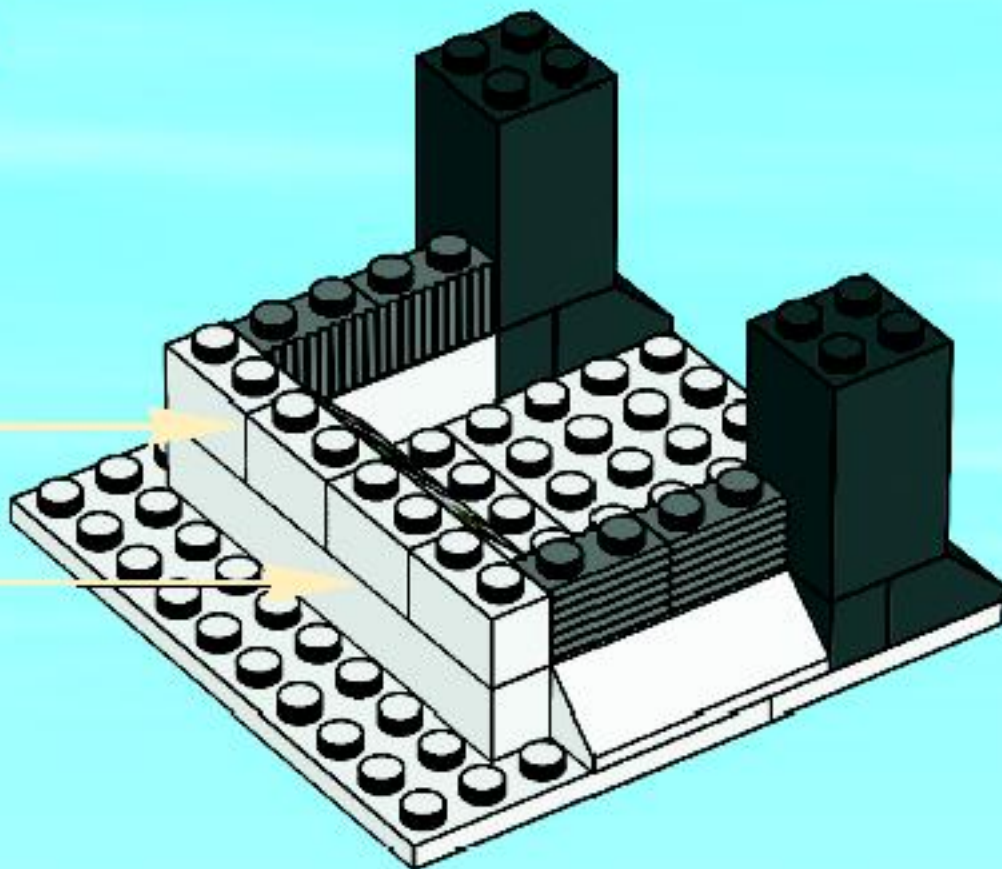

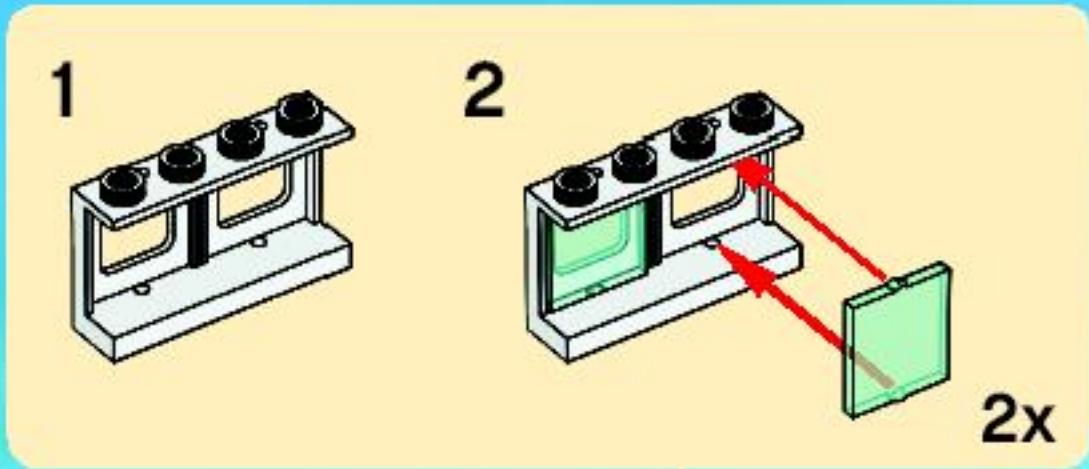

9

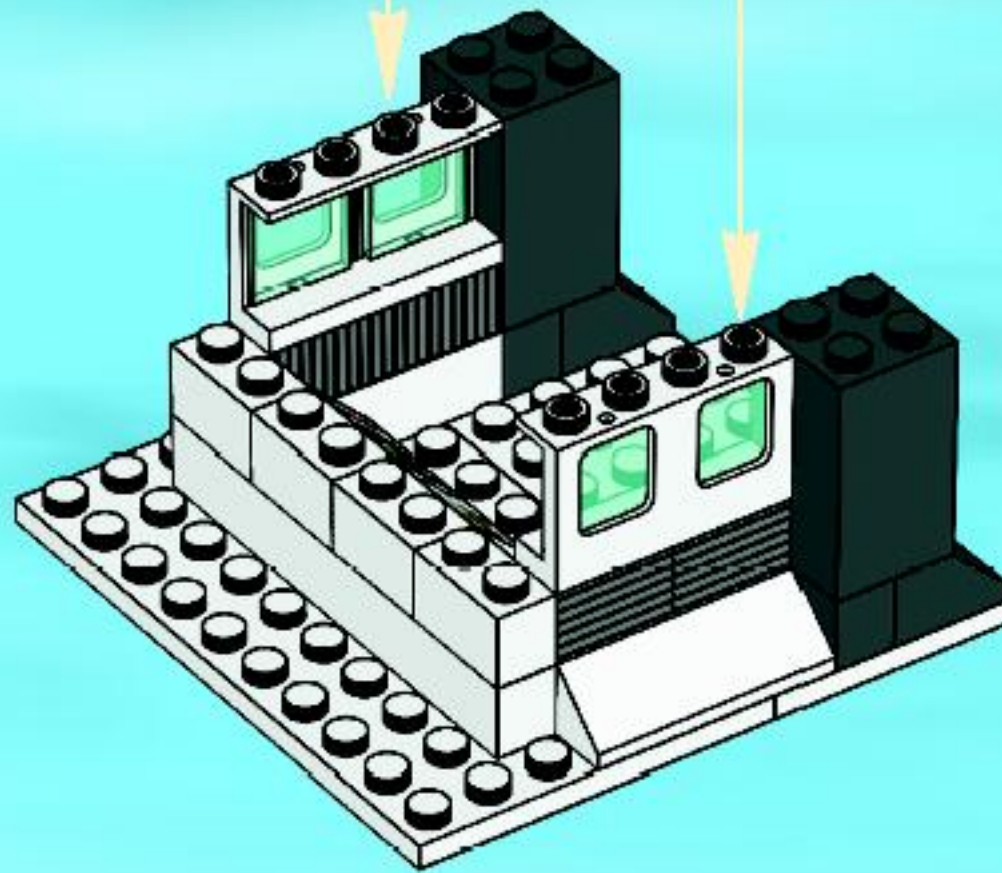

10

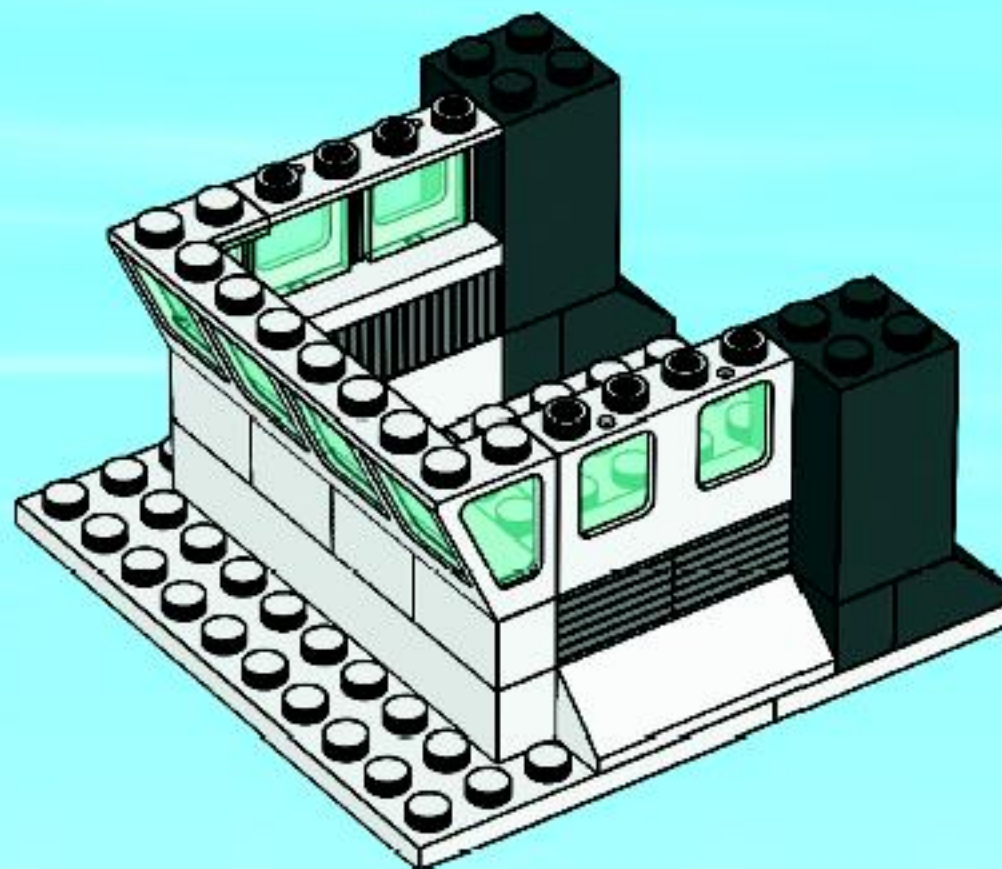



11

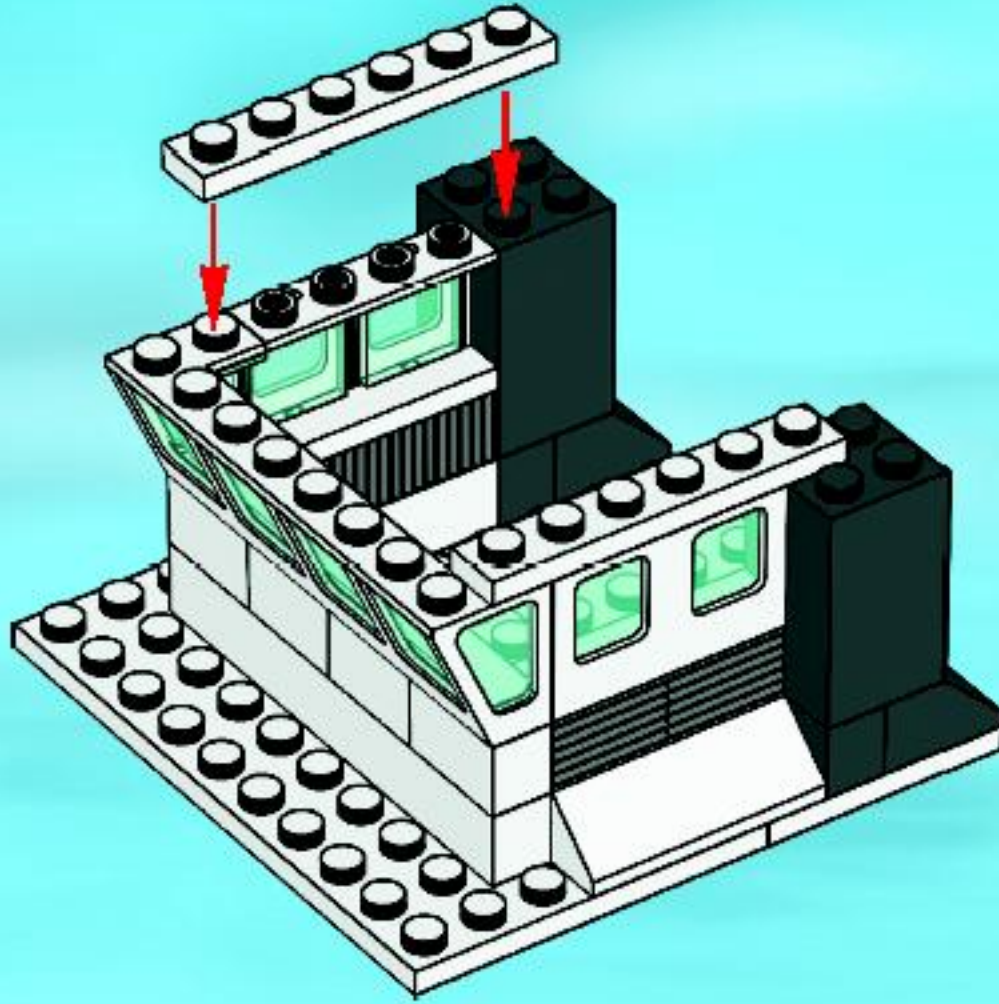

12

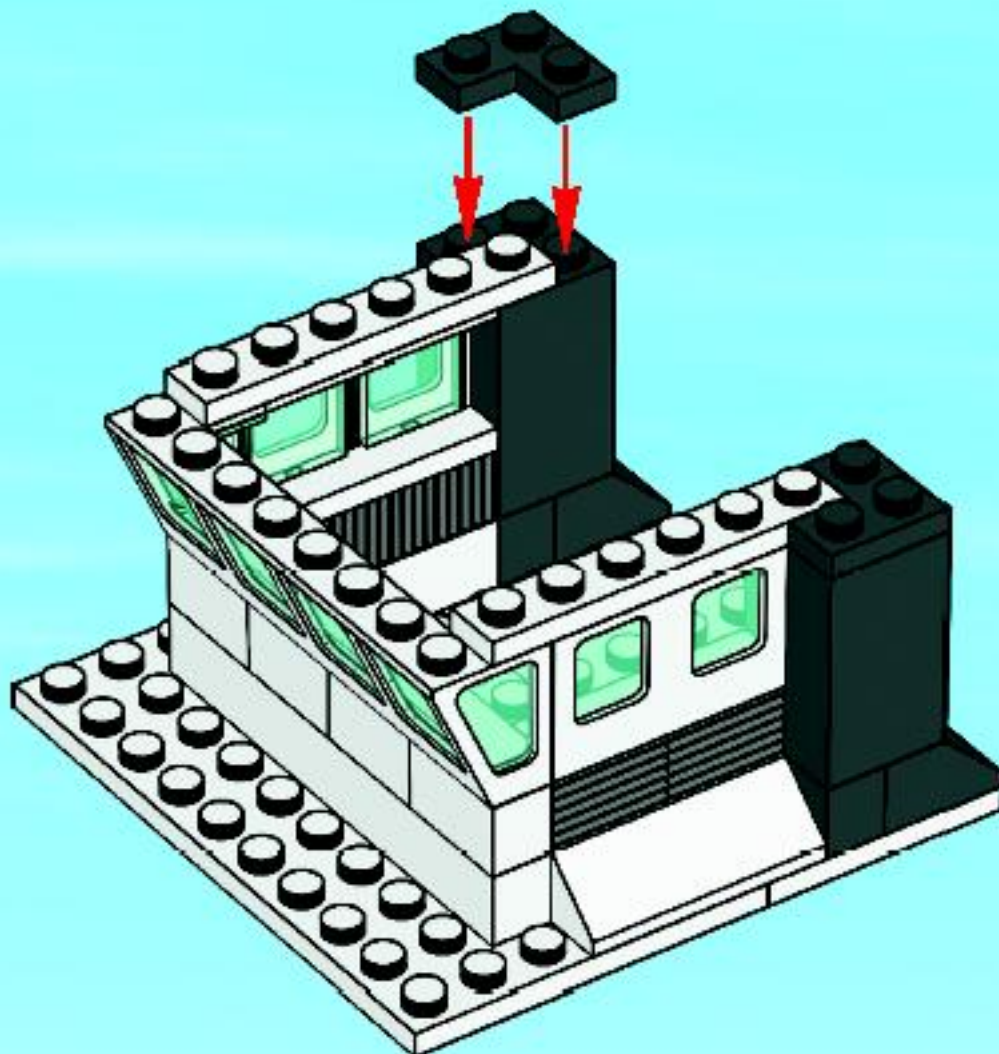

13

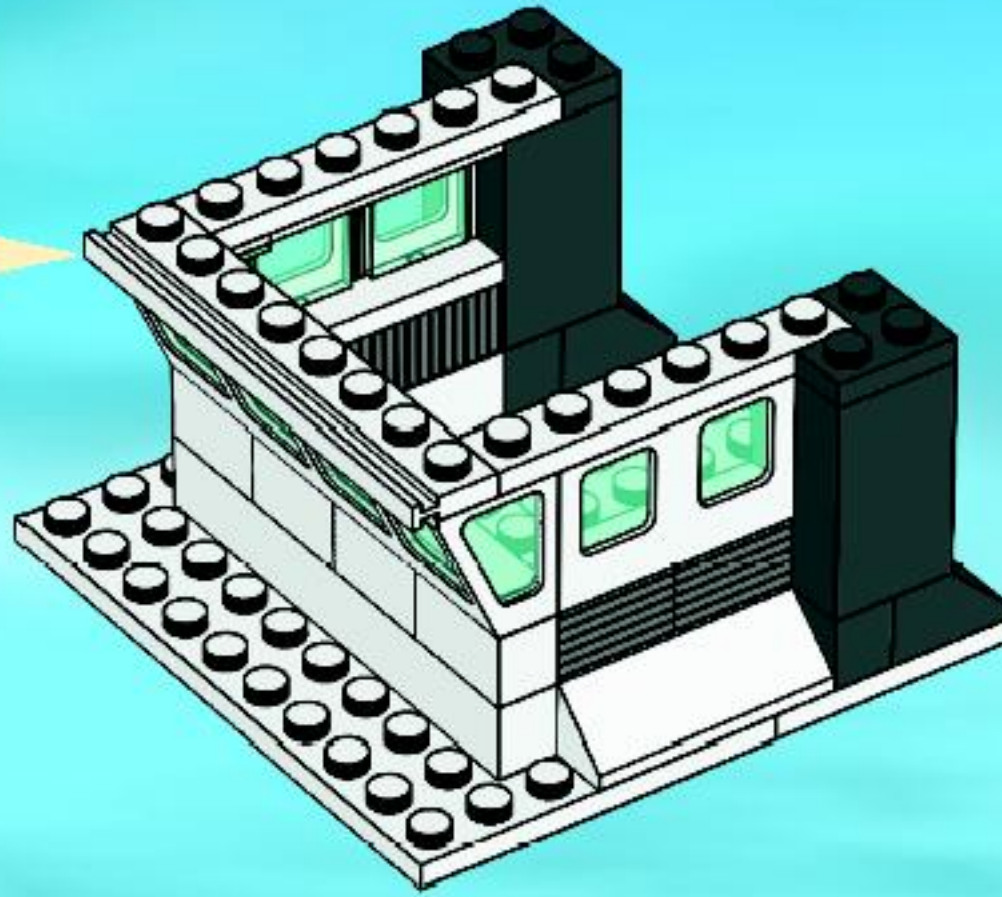
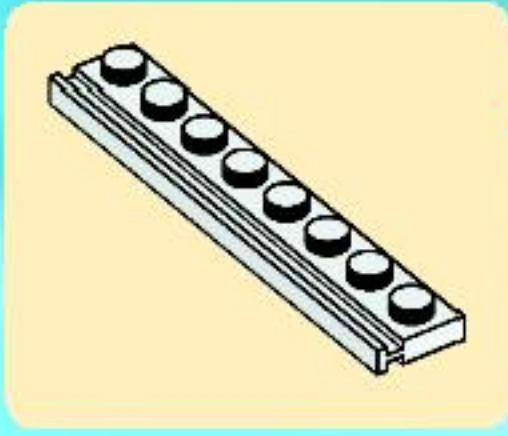

14

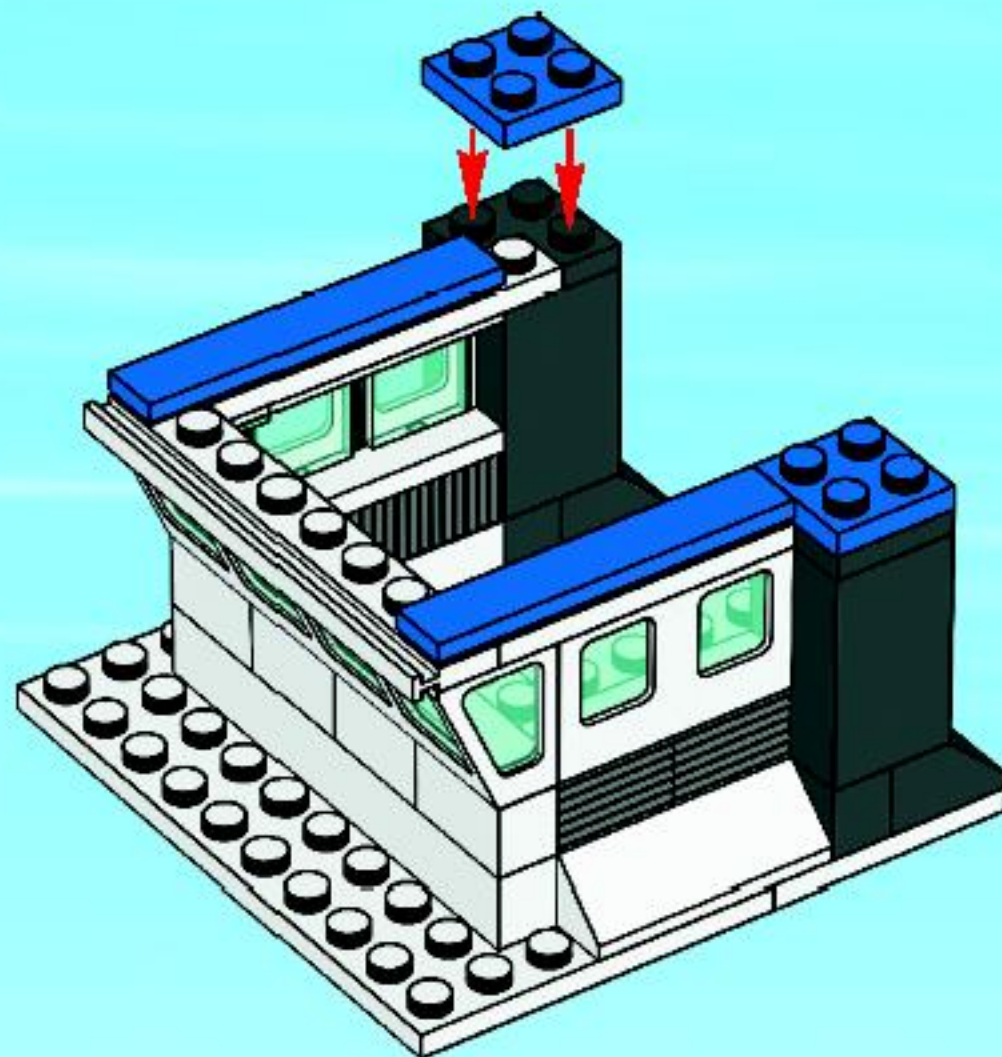

15

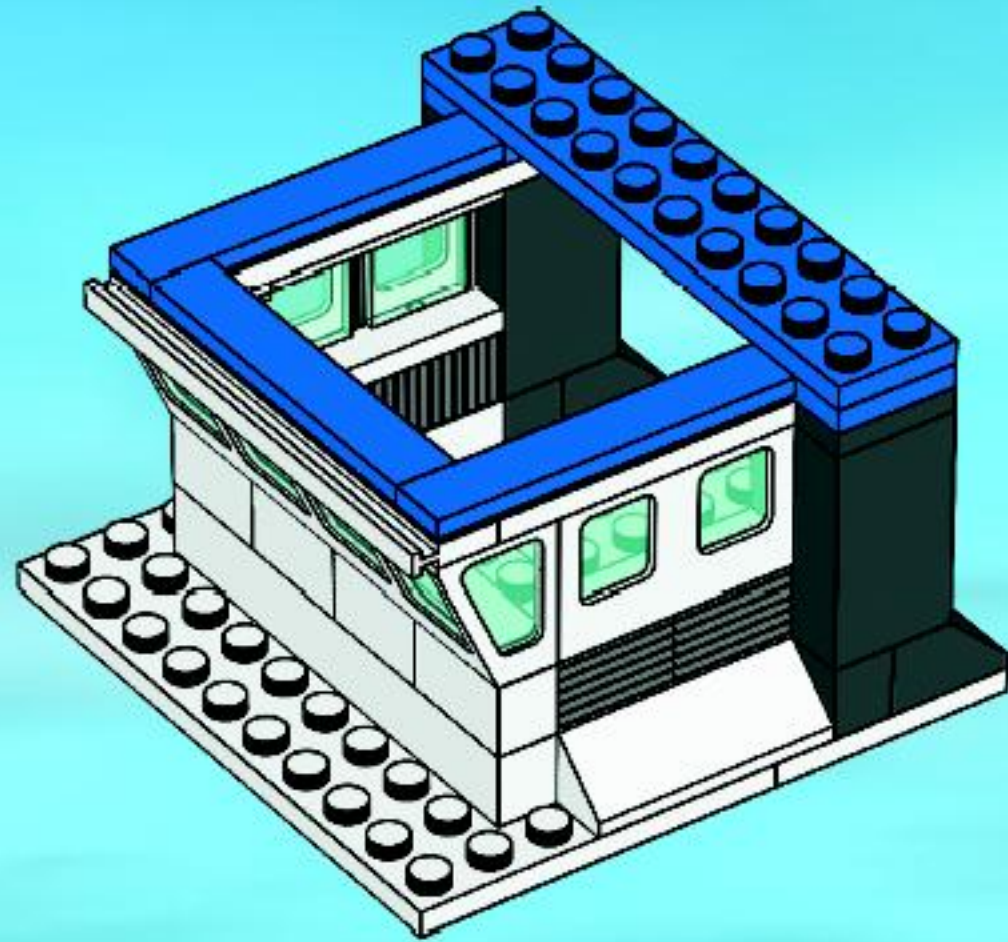

16

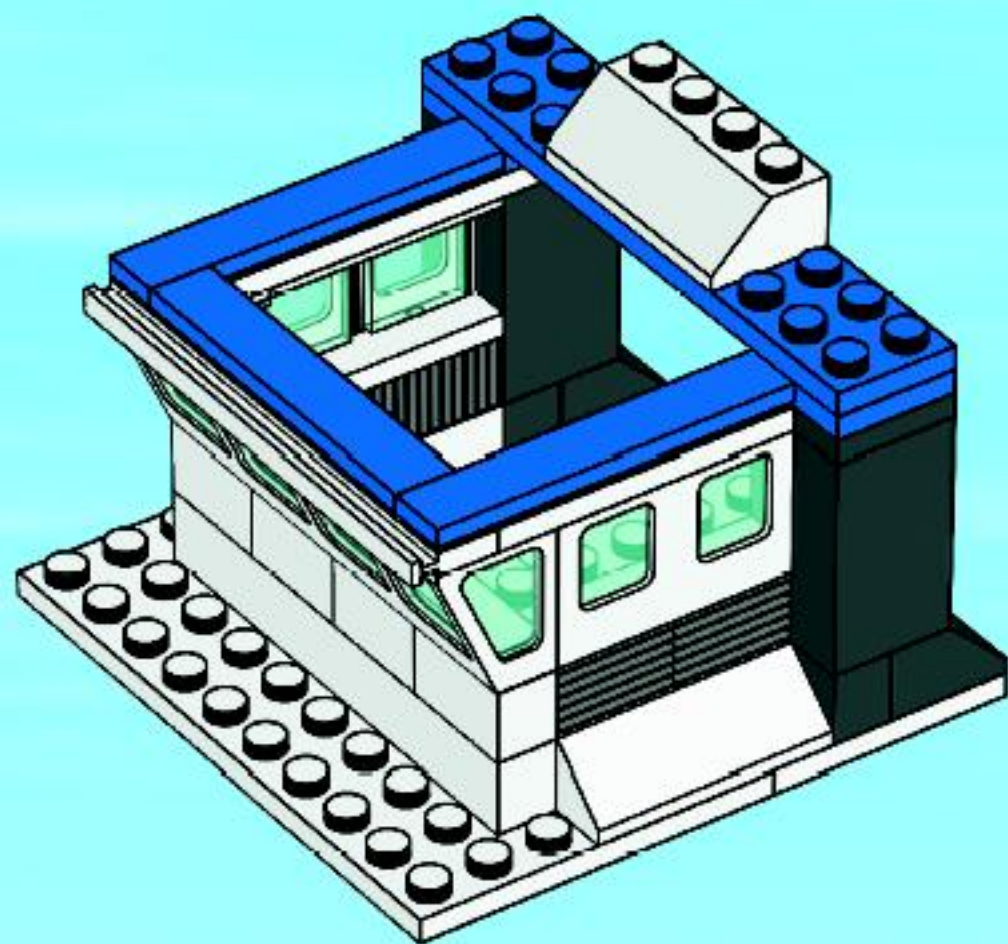

1

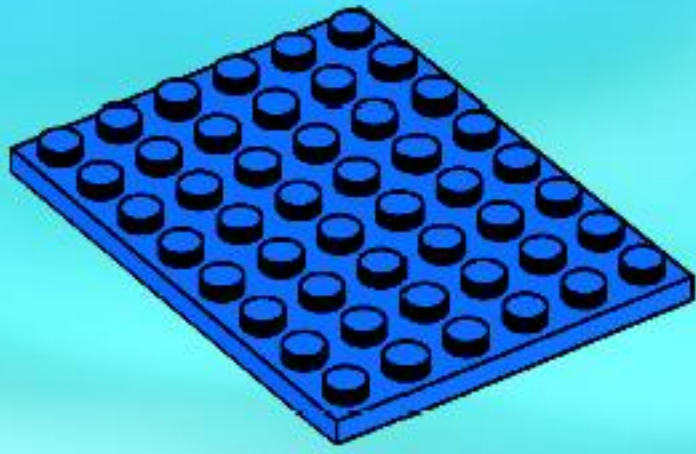

4

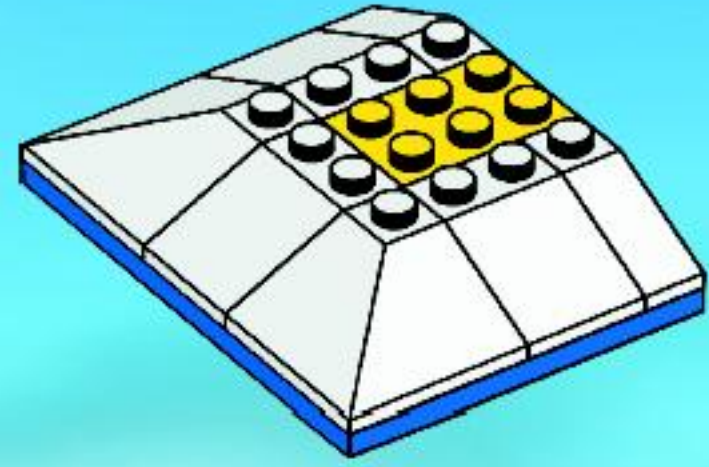

2

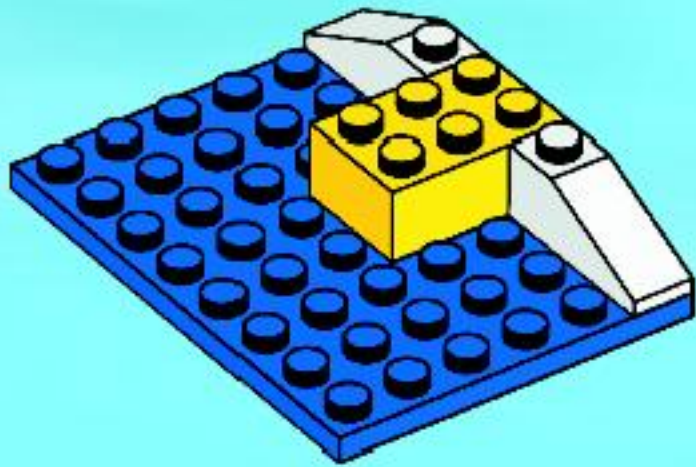

5

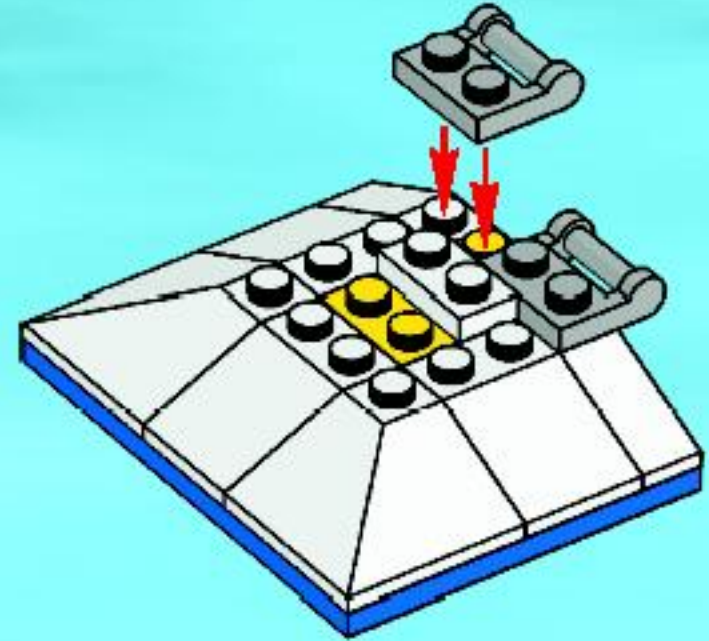

3

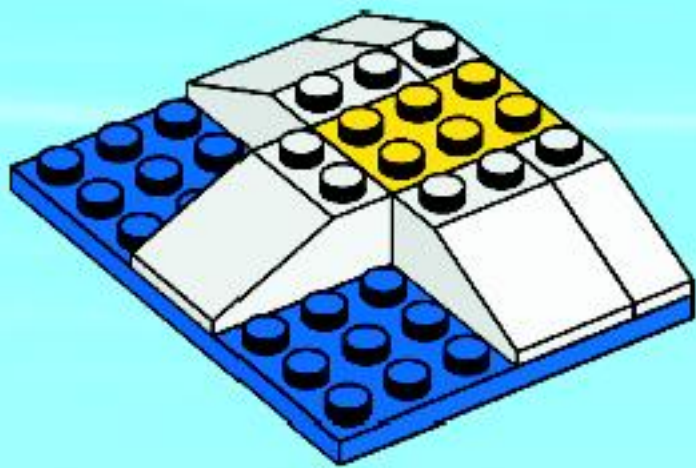

6

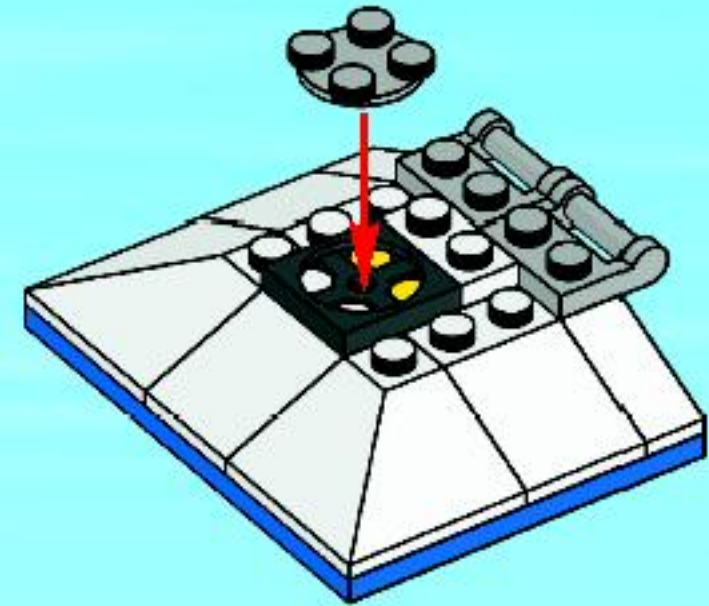

7

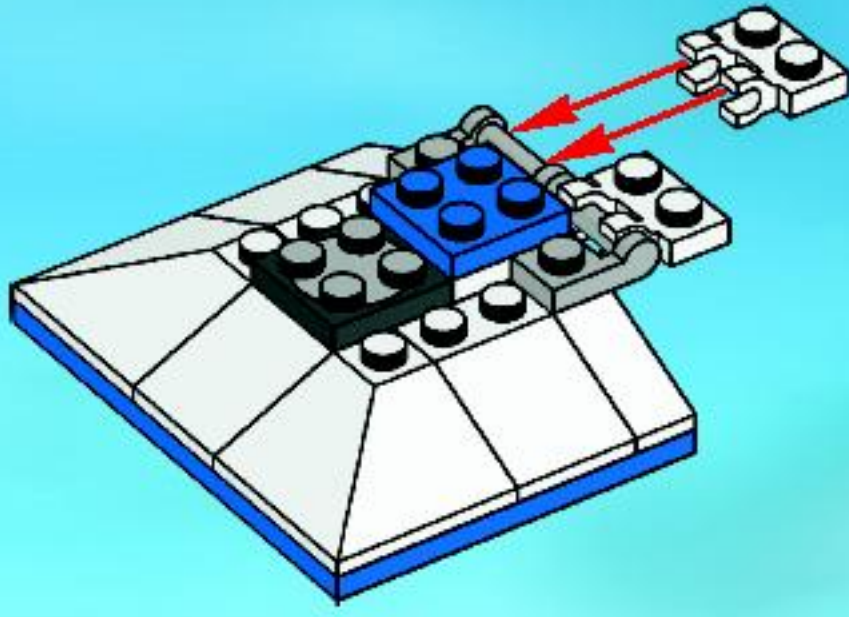

8

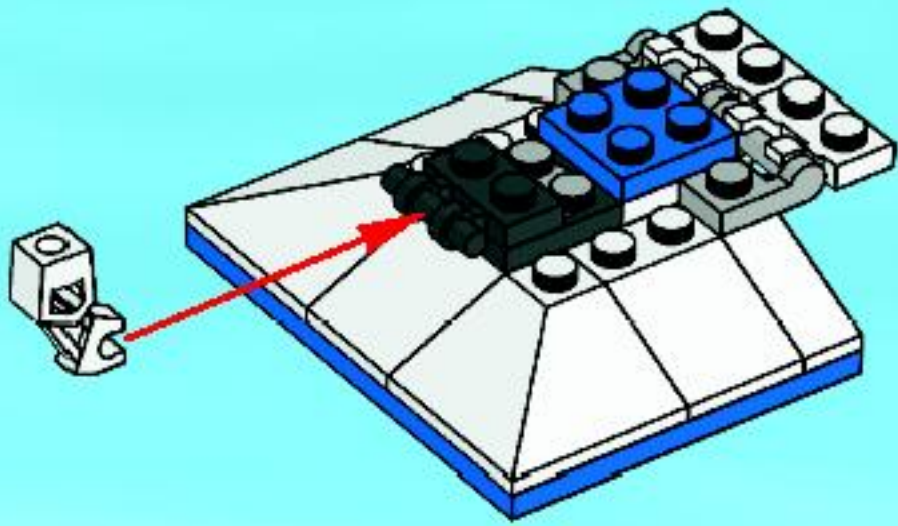

9

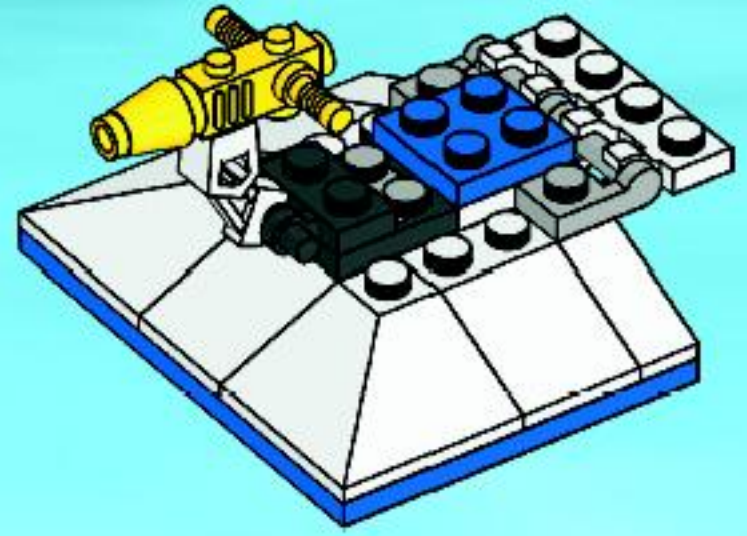
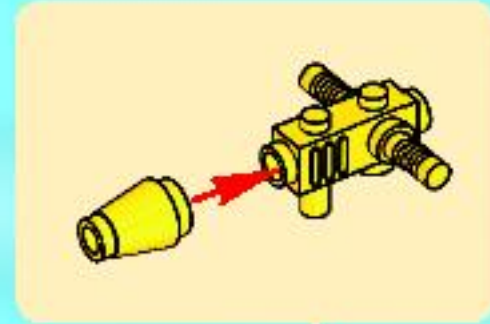

17

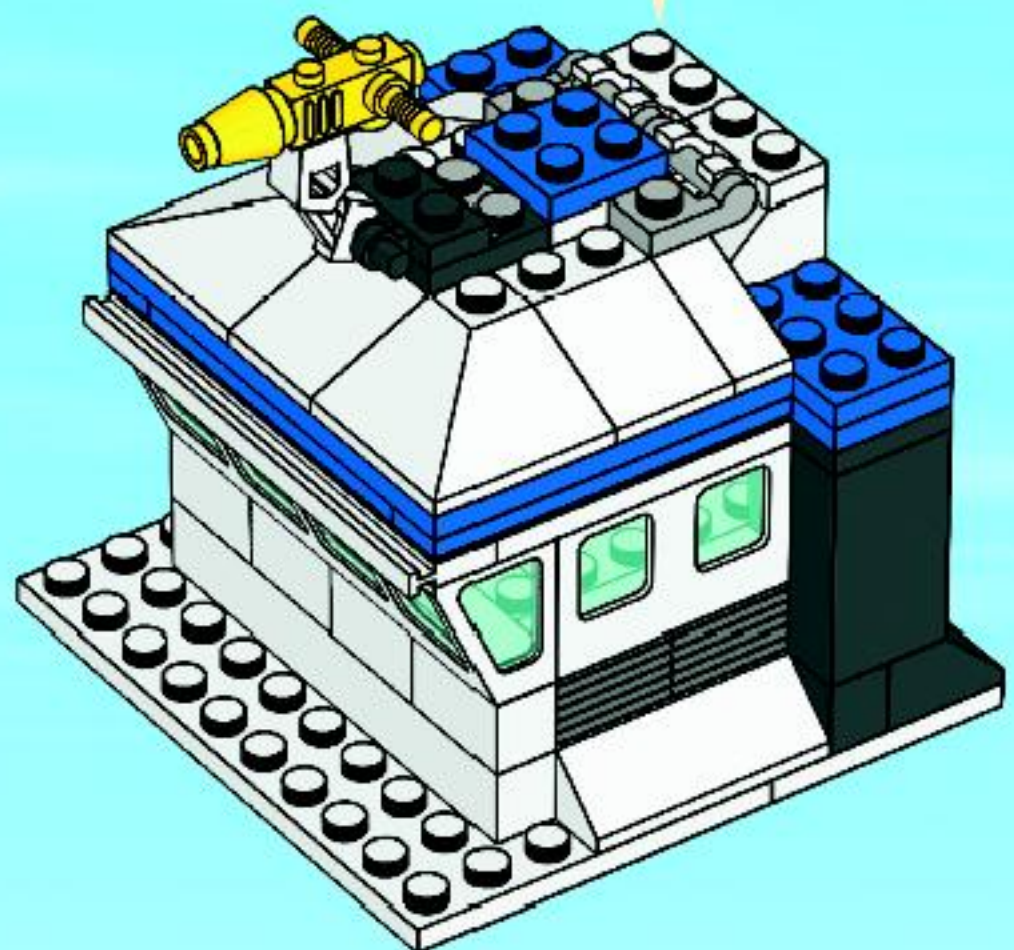

1

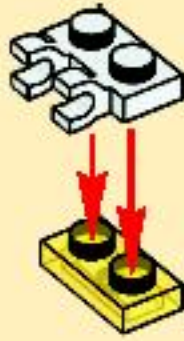

2



18

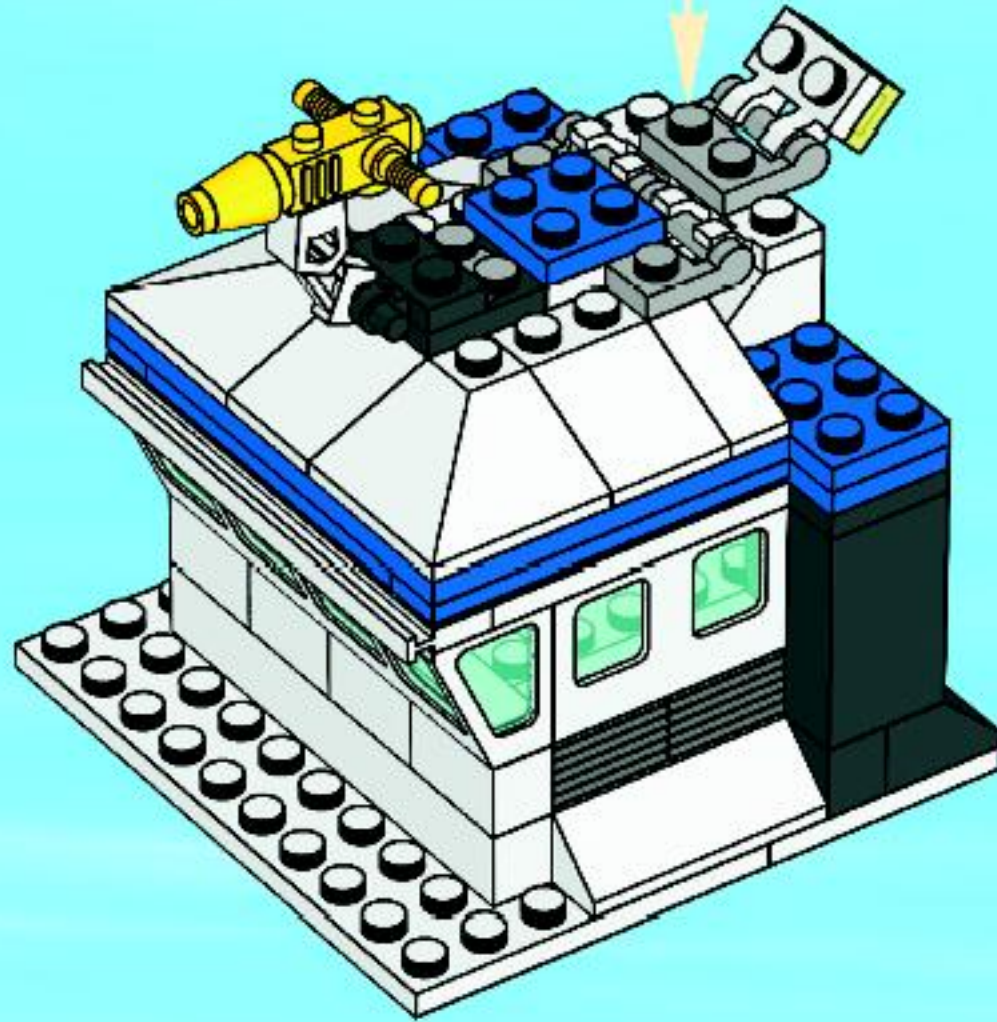

1

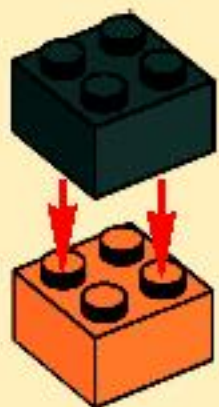

2



3

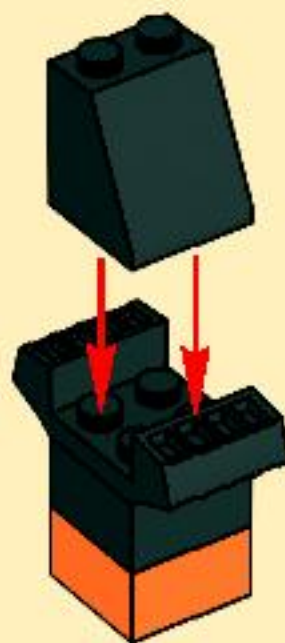

4



2x

19

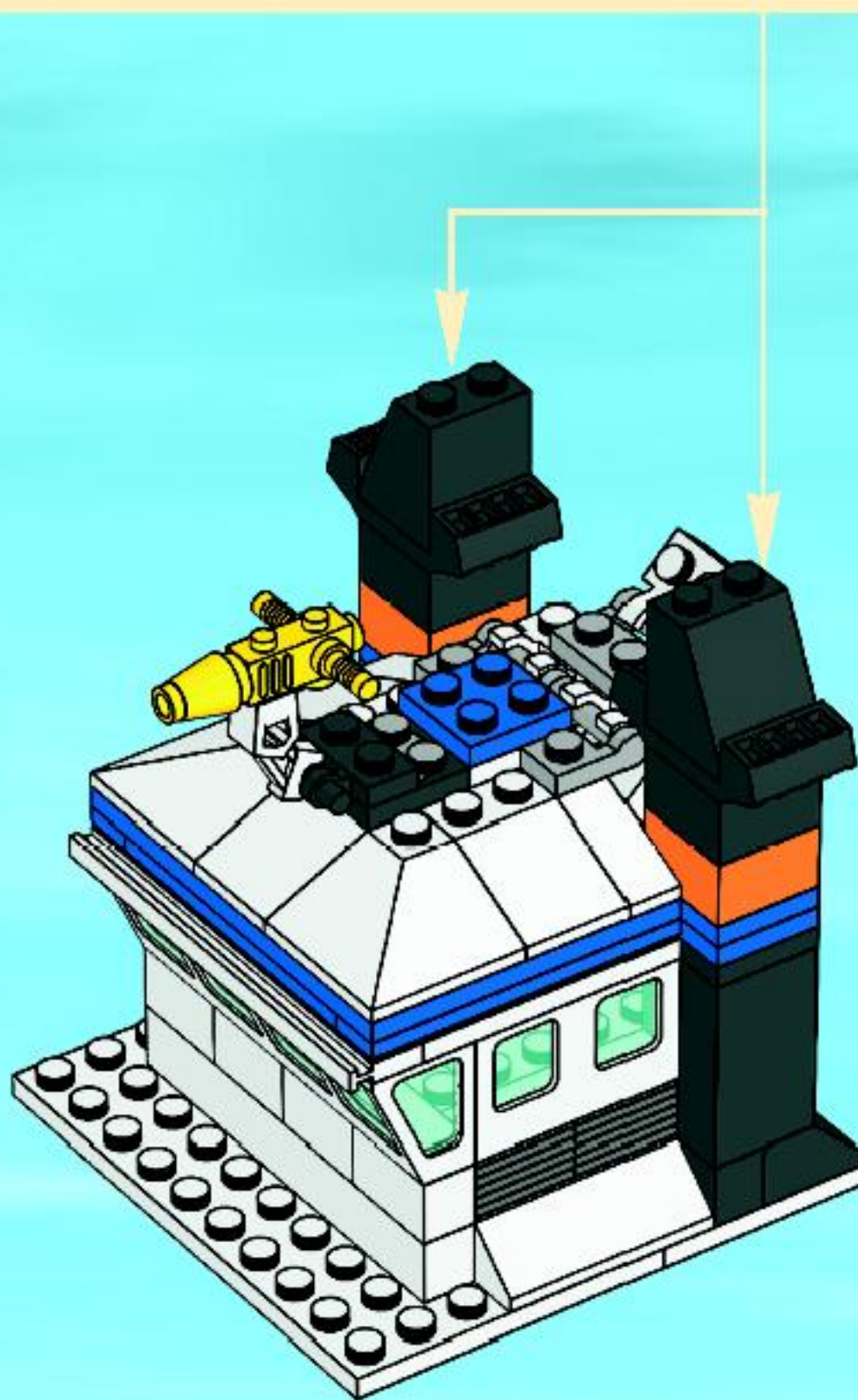

20

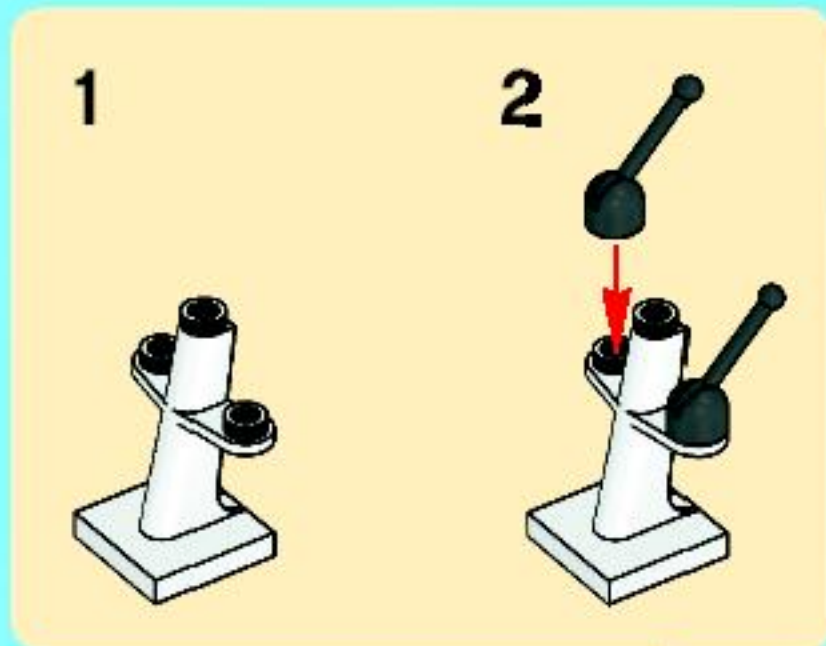
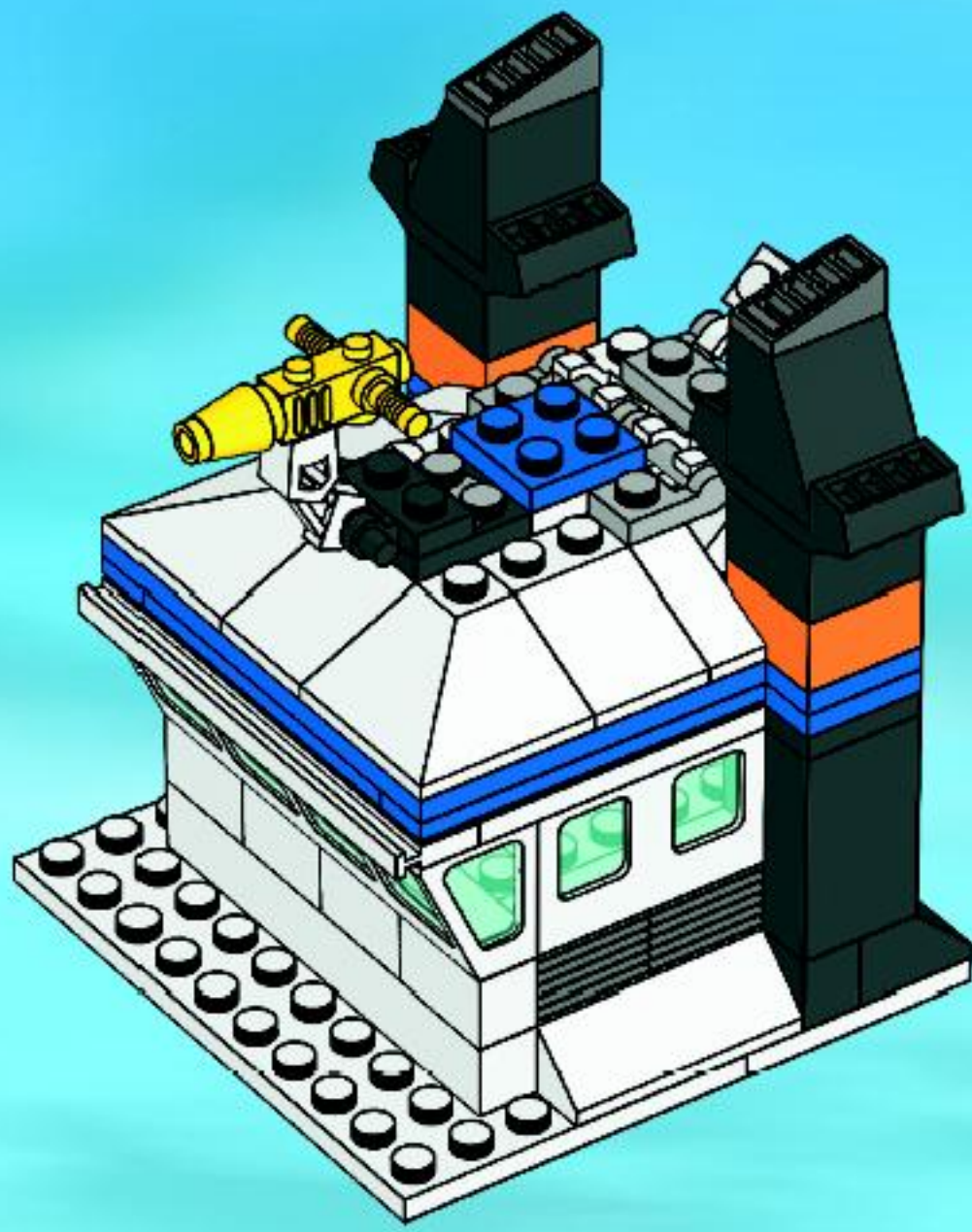

21

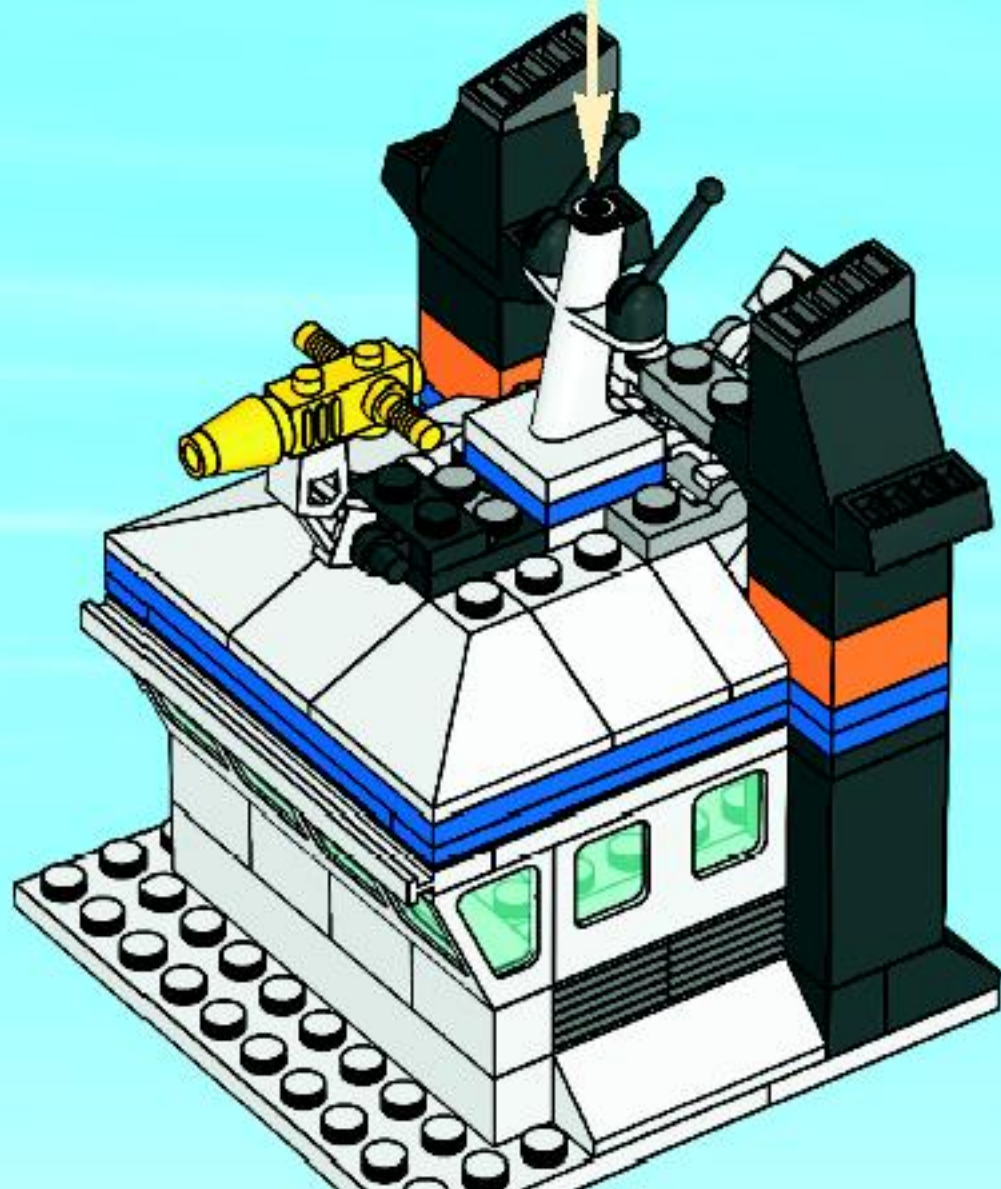



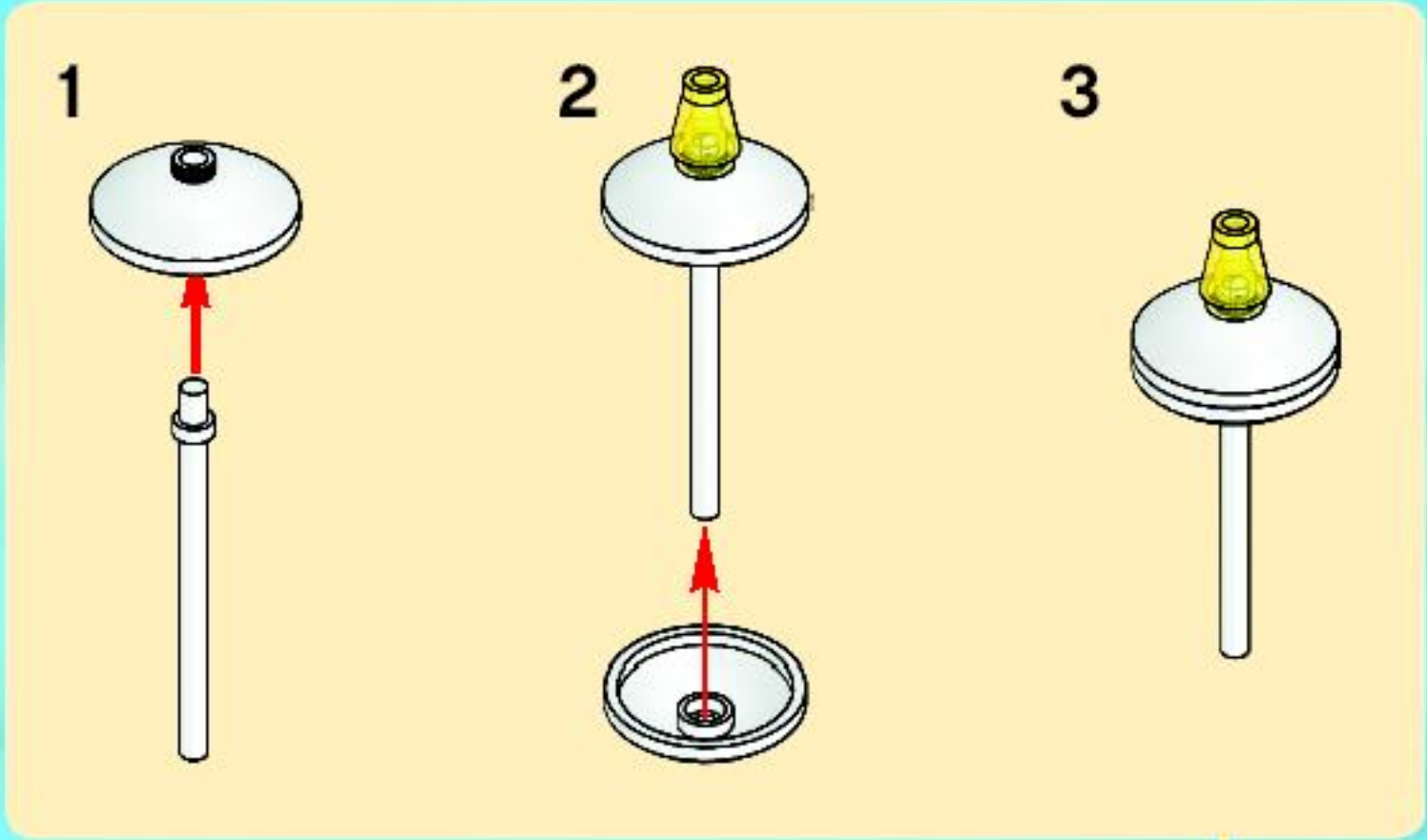

22

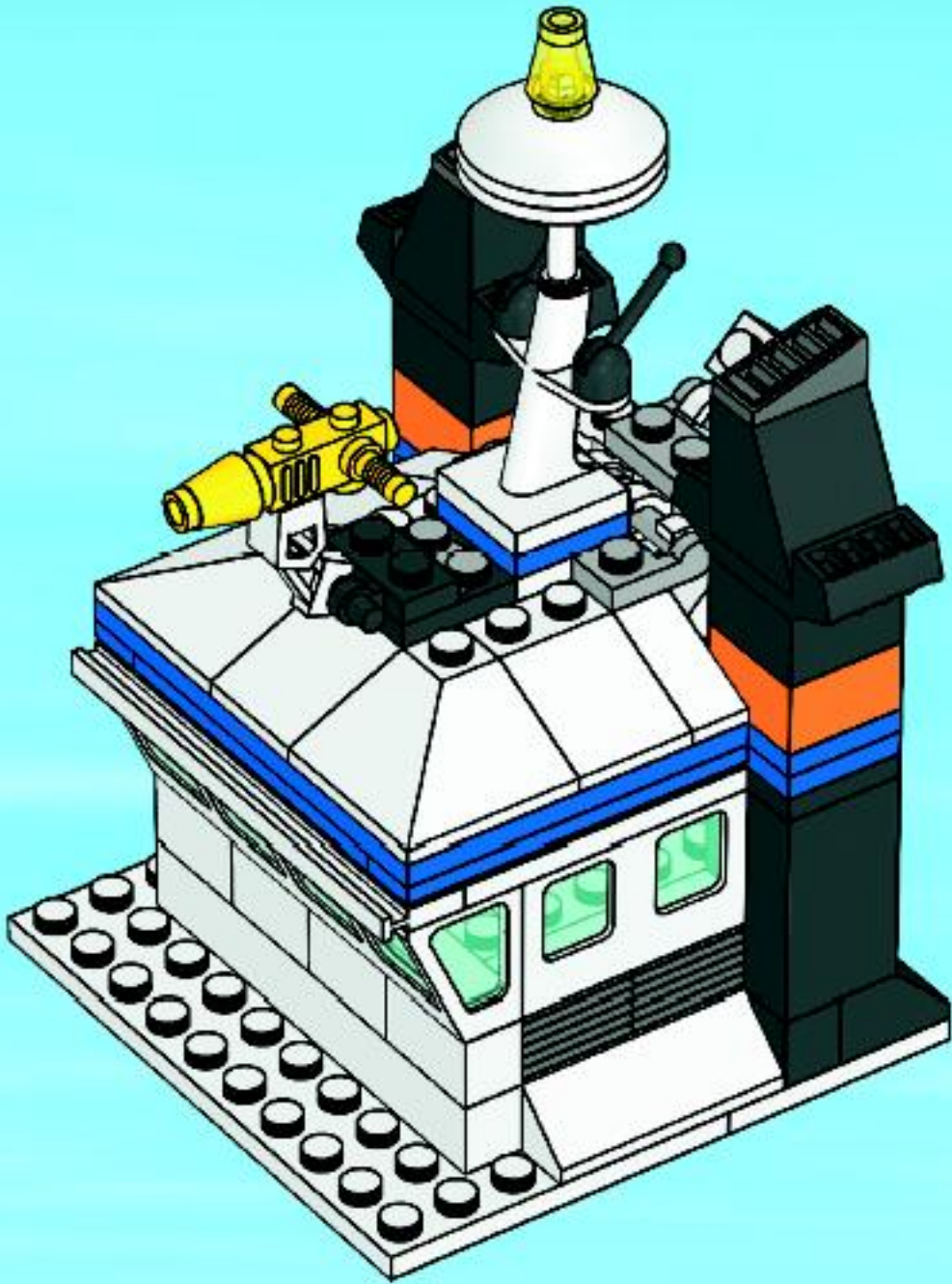

23



24

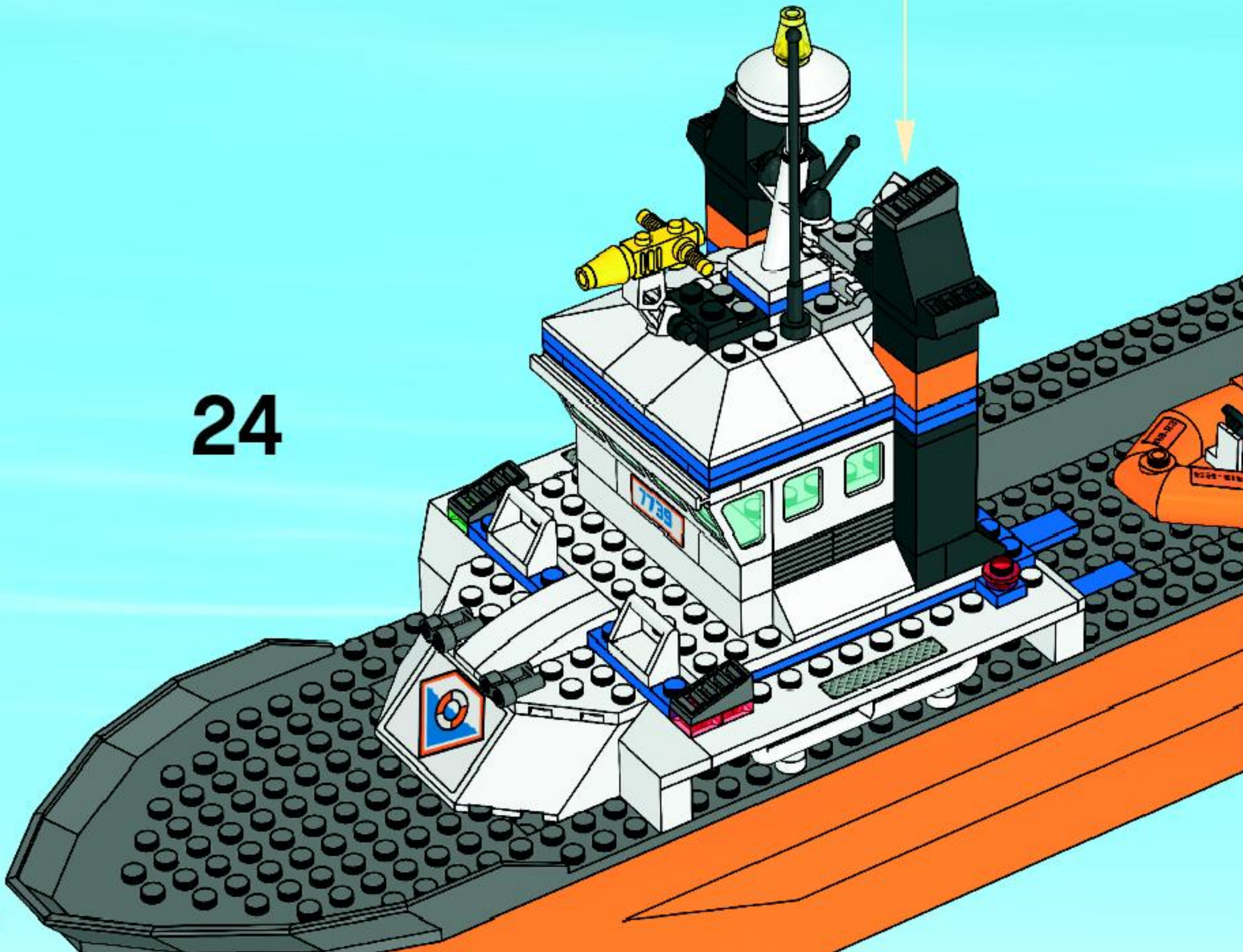

25

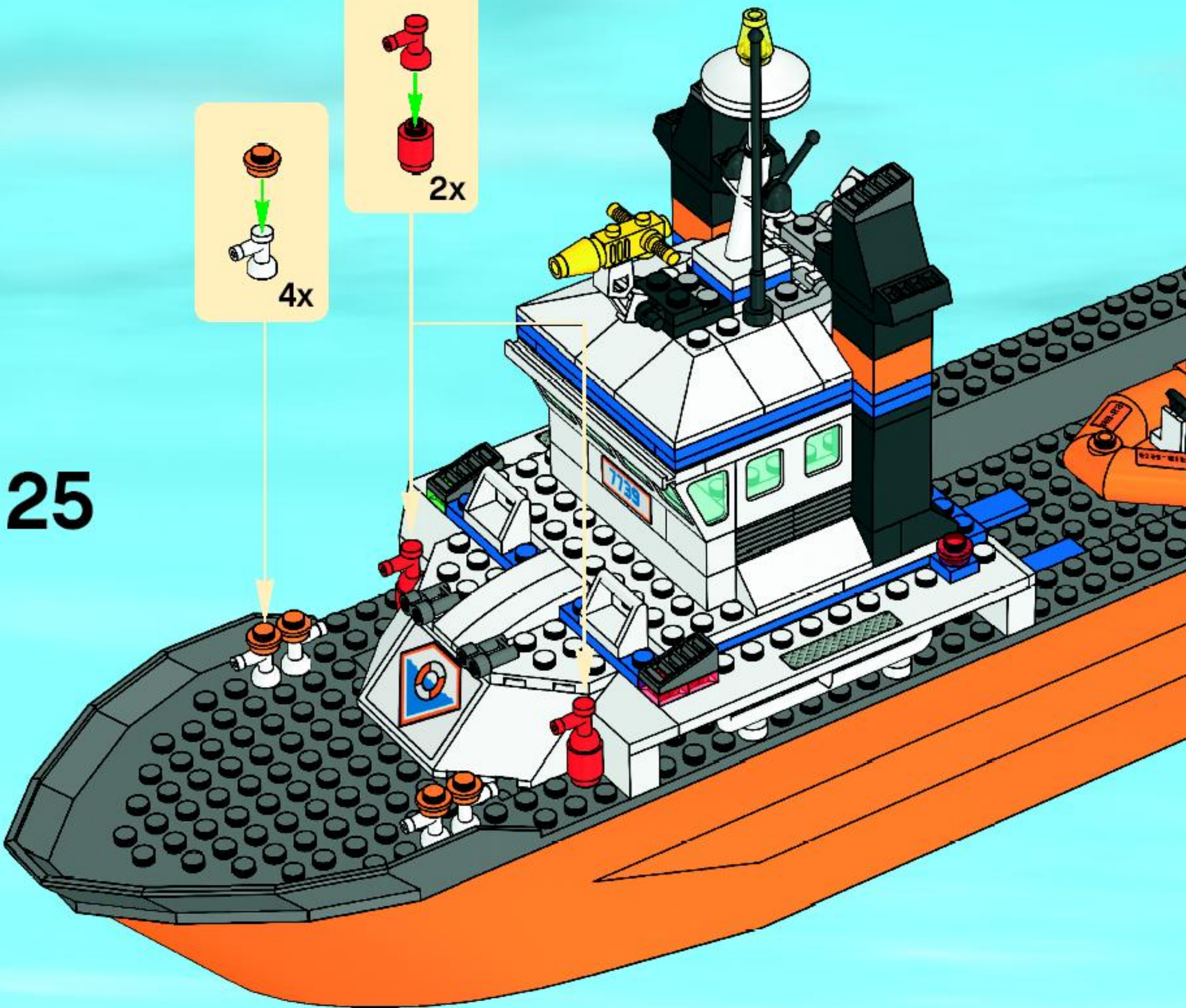
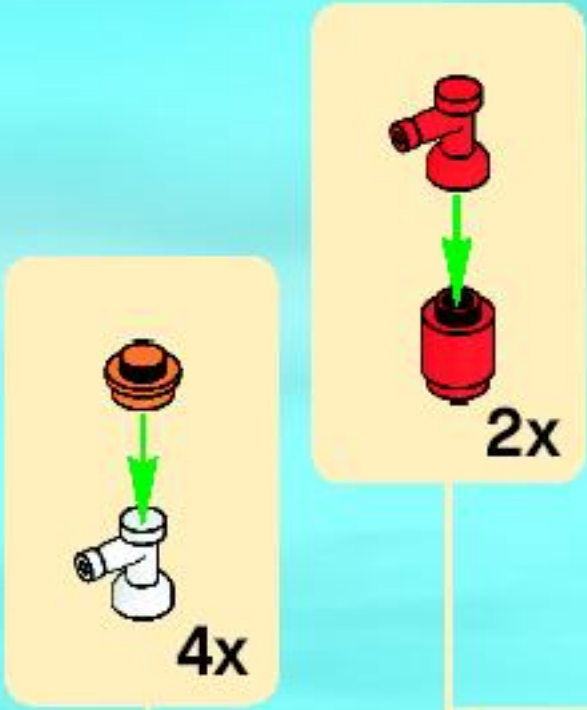

1



2



3

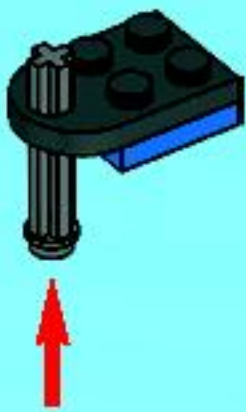

4



5



6

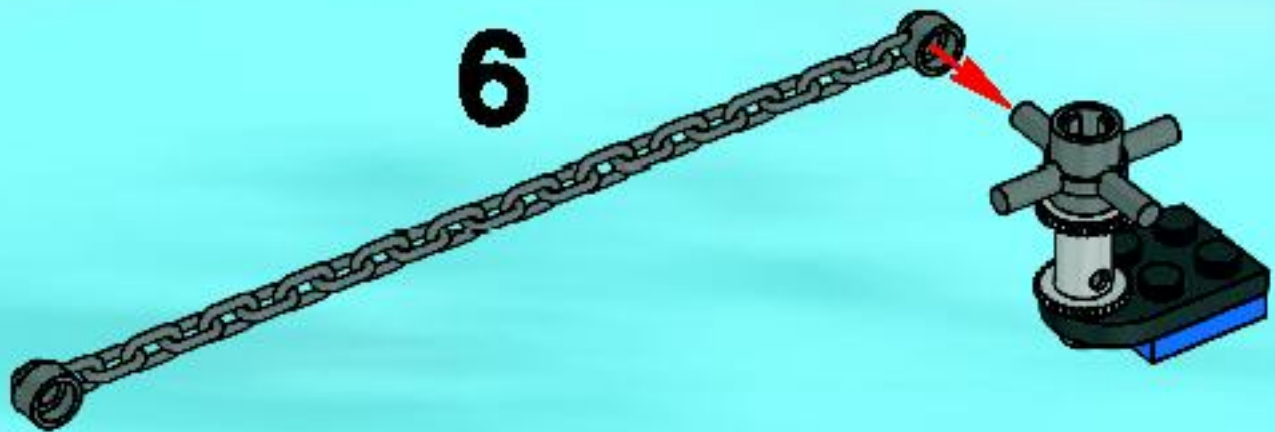

7

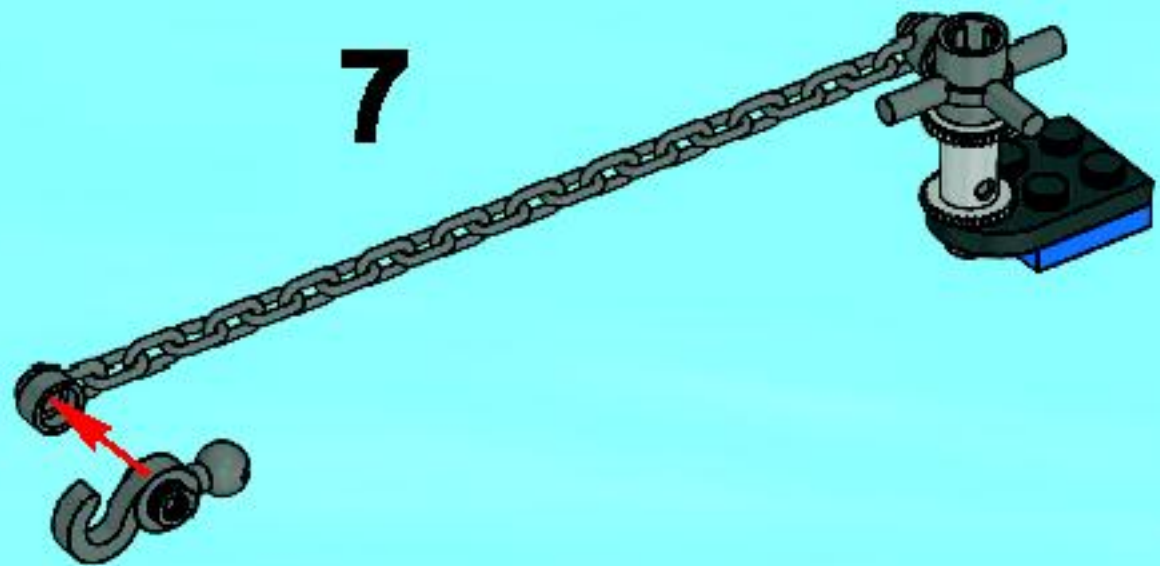

8

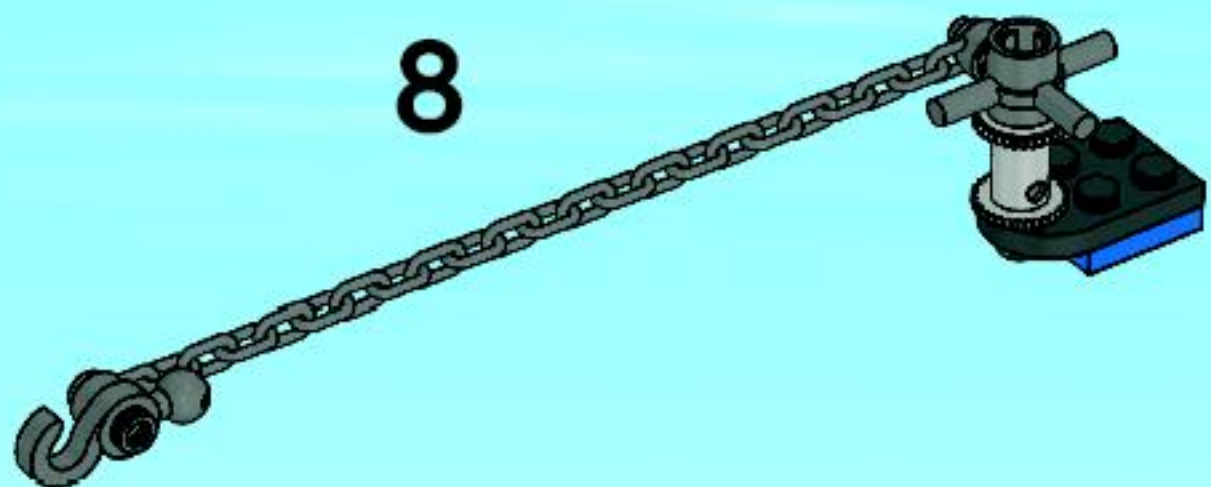

26

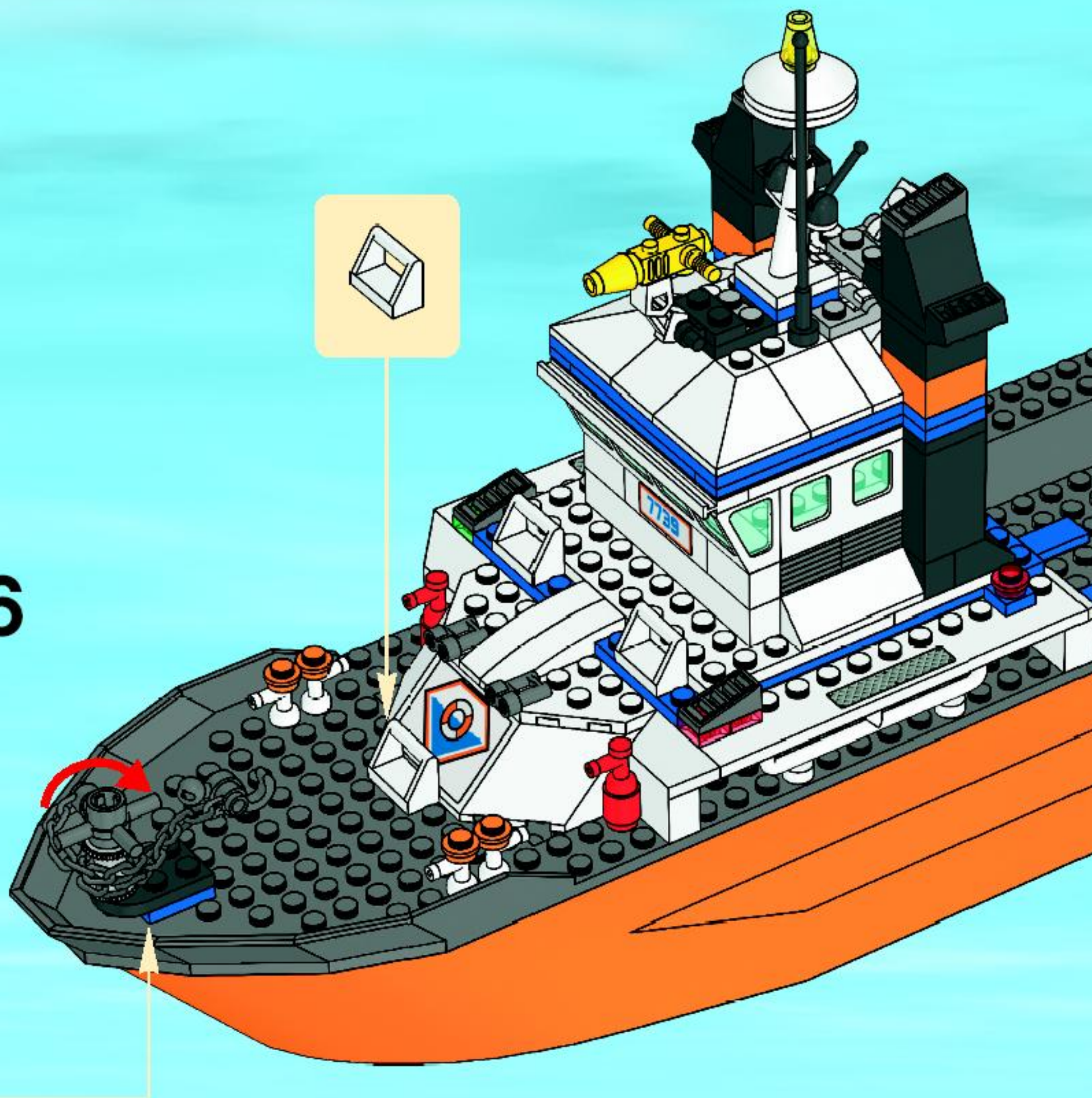

27

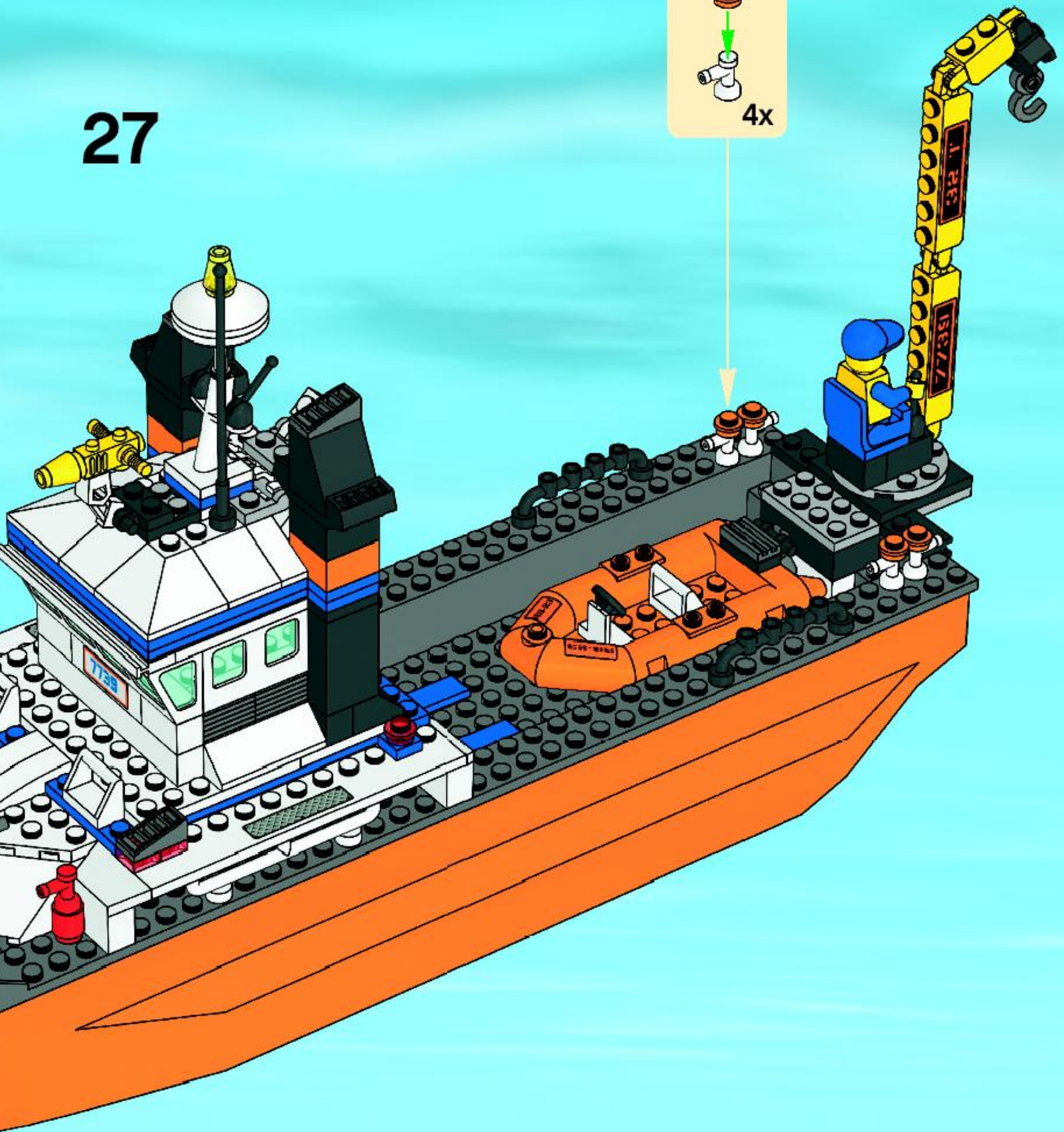
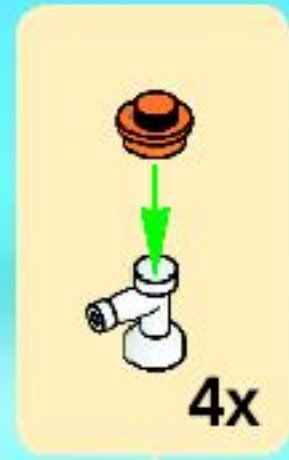

28

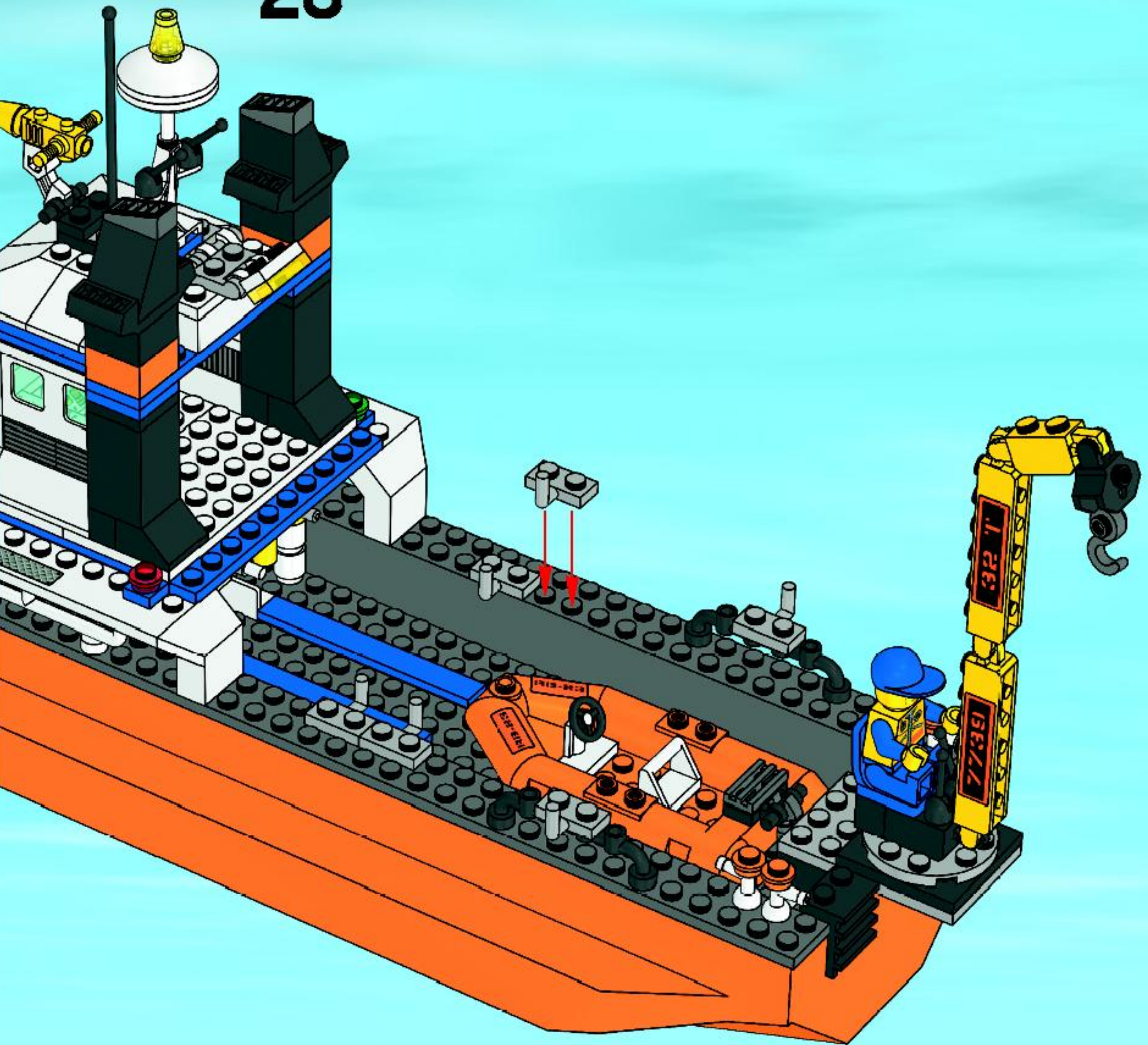

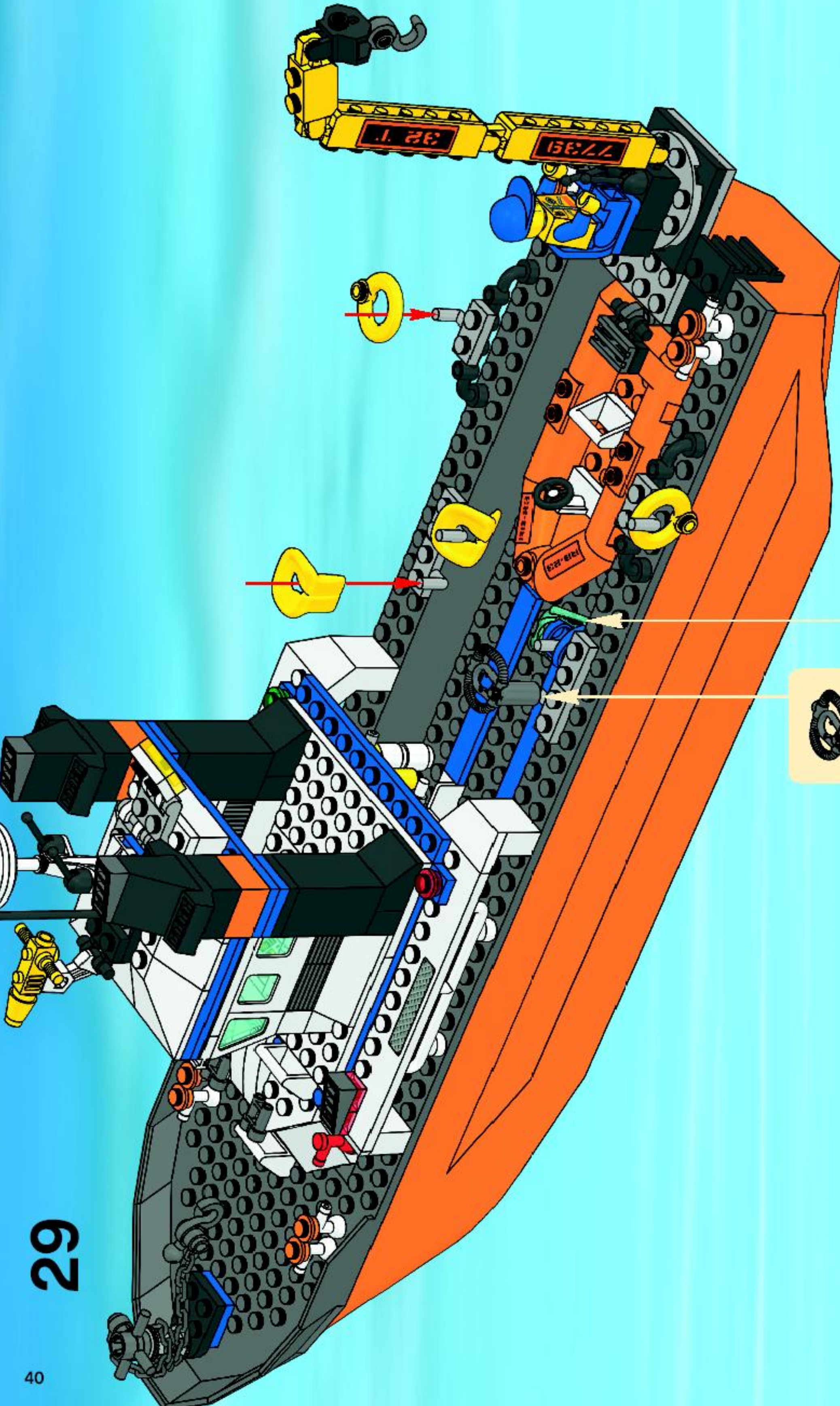





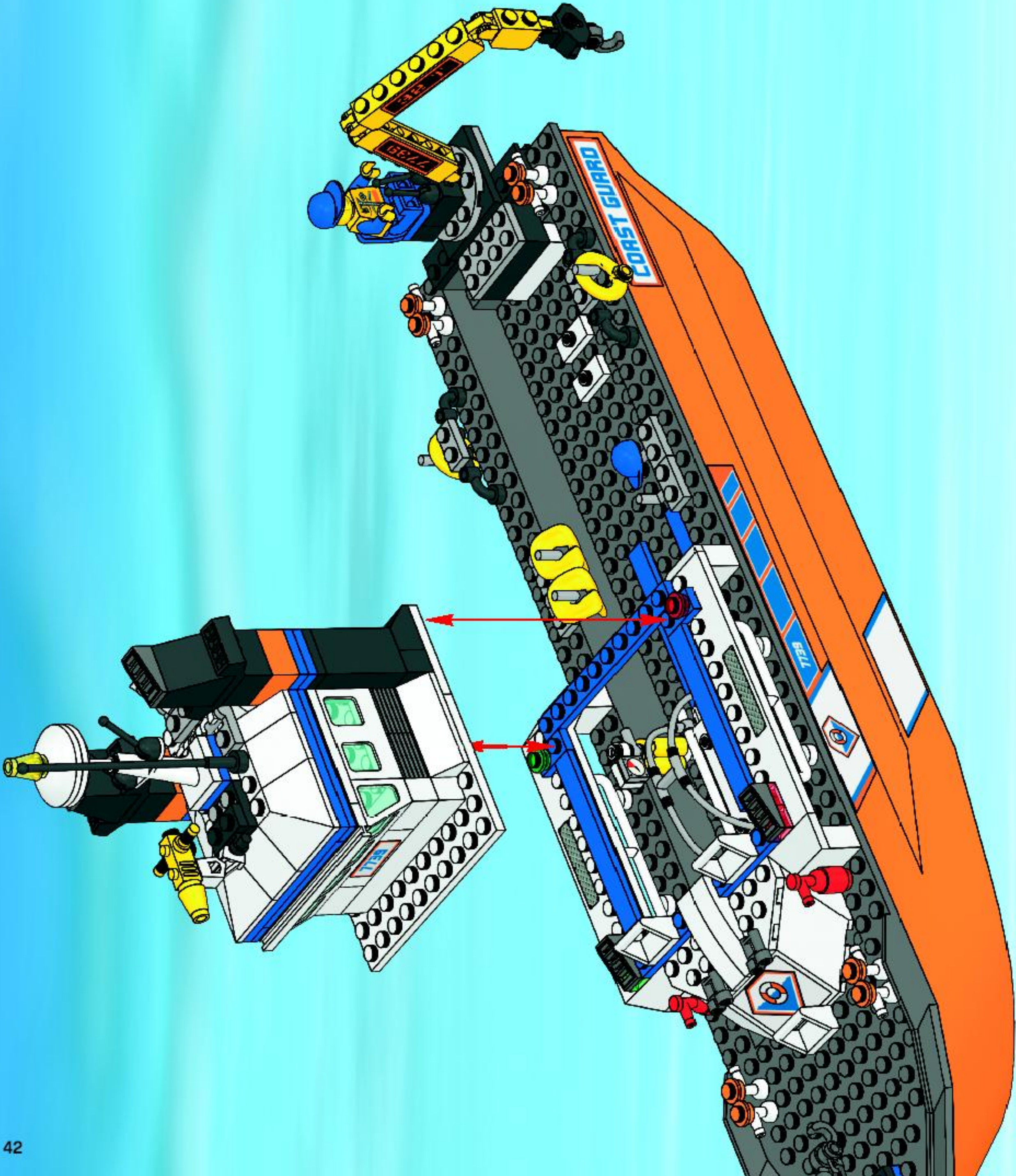
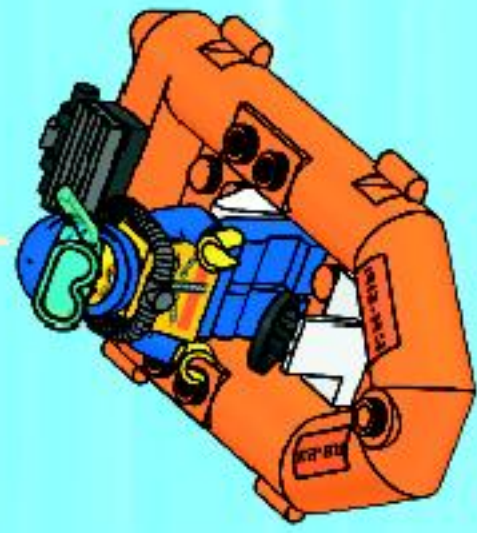
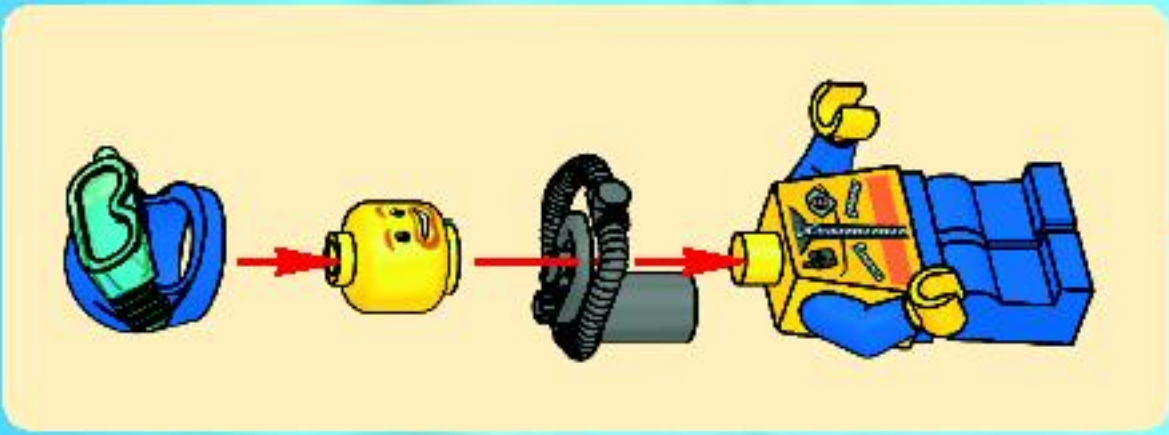



**YES! I want to join the LEGO® Club FREE! OUI! Je veux m'abonner au Club LEGO GRATUITEMENT! Ja! Ich möchte Mitglied im kostenlosen LEGO Club werden. Ja! Ik wil graag GRATIS lid worden van de LEGO Club.**

First Name  
Prénom  
Forename  
Voornamen  
Last Name  
Nom de famille  
Mail Name  
Mail Name  
Action Name  
Street, 1 to  
Rue  
Street Name  
Straat No. / Weg  
City/Country  
Ville  
Staat  
Woonplaats  
Zip/Postcode  
Code Postal  
PC  
Postcode  
Date of Birth  
Date de naissance  
Geboortedatum

<input type="checkbox"/>	<input type="checkbox"/>	<input type="checkbox"/>	<input type="checkbox"/>	<input type="checkbox"/>	<input type="checkbox"/>	<input type="checkbox"/>	<input type="checkbox"/>	<input type="checkbox"/>	<input type="checkbox"/>	<input type="checkbox"/>	<input type="checkbox"/>	<input type="checkbox"/>	<input type="checkbox"/>	<input type="checkbox"/>	<input type="checkbox"/>	<input type="checkbox"/>	<input type="checkbox"/>	<input type="checkbox"/>	<input type="checkbox"/>
Boy Garçon Junge	<input type="checkbox"/>	<input type="checkbox"/>	<input type="checkbox"/>	<input type="checkbox"/>	<input type="checkbox"/>	<input type="checkbox"/>	<input type="checkbox"/>	<input type="checkbox"/>	<input type="checkbox"/>	<input type="checkbox"/>	<input type="checkbox"/>	<input type="checkbox"/>	<input type="checkbox"/>	<input type="checkbox"/>	<input type="checkbox"/>	<input type="checkbox"/>	<input type="checkbox"/>	<input type="checkbox"/>	<input type="checkbox"/>
Girl Fille Mädchen Meisje	<input type="checkbox"/>	<input type="checkbox"/>	<input type="checkbox"/>	<input type="checkbox"/>	<input type="checkbox"/>	<input type="checkbox"/>	<input type="checkbox"/>	<input type="checkbox"/>	<input type="checkbox"/>	<input type="checkbox"/>	<input type="checkbox"/>	<input type="checkbox"/>	<input type="checkbox"/>	<input type="checkbox"/>	<input type="checkbox"/>	<input type="checkbox"/>	<input type="checkbox"/>	<input type="checkbox"/>	<input type="checkbox"/>
<input type="checkbox"/>	<input type="checkbox"/>	<input type="checkbox"/>	<input type="checkbox"/>	<input type="checkbox"/>	<input type="checkbox"/>	<input type="checkbox"/>	<input type="checkbox"/>	<input type="checkbox"/>	<input type="checkbox"/>	<input type="checkbox"/>	<input type="checkbox"/>	<input type="checkbox"/>	<input type="checkbox"/>	<input type="checkbox"/>	<input type="checkbox"/>	<input type="checkbox"/>	<input type="checkbox"/>	<input type="checkbox"/>	<input type="checkbox"/>
<input type="checkbox"/>	<input type="checkbox"/>	<input type="checkbox"/>	<input type="checkbox"/>	<input type="checkbox"/>	<input type="checkbox"/>	<input type="checkbox"/>	<input type="checkbox"/>	<input type="checkbox"/>	<input type="checkbox"/>	<input type="checkbox"/>	<input type="checkbox"/>	<input type="checkbox"/>	<input type="checkbox"/>	<input type="checkbox"/>	<input type="checkbox"/>	<input type="checkbox"/>	<input type="checkbox"/>	<input type="checkbox"/>	<input type="checkbox"/>
<input type="checkbox"/>	<input type="checkbox"/>	<input type="checkbox"/>	<input type="checkbox"/>	<input type="checkbox"/>	<input type="checkbox"/>	<input type="checkbox"/>	<input type="checkbox"/>	<input type="checkbox"/>	<input type="checkbox"/>	<input type="checkbox"/>	<input type="checkbox"/>	<input type="checkbox"/>	<input type="checkbox"/>	<input type="checkbox"/>	<input type="checkbox"/>	<input type="checkbox"/>	<input type="checkbox"/>	<input type="checkbox"/>	<input type="checkbox"/>
<input type="checkbox"/>	<input type="checkbox"/>	<input type="checkbox"/>	<input type="checkbox"/>	<input type="checkbox"/>	<input type="checkbox"/>	<input type="checkbox"/>	<input type="checkbox"/>	<input type="checkbox"/>	<input type="checkbox"/>	<input type="checkbox"/>	<input type="checkbox"/>	<input type="checkbox"/>	<input type="checkbox"/>	<input type="checkbox"/>	<input type="checkbox"/>	<input type="checkbox"/>	<input type="checkbox"/>	<input type="checkbox"/>	<input type="checkbox"/>

Parent's Signature  
Signature des Parents  
Name of the Educational Institution  
Namen van de Onderwijsinstelling

<input type="checkbox"/>	<input type="checkbox"/>	<input type="checkbox"/>	<input type="checkbox"/>	<input type="checkbox"/>	<input type="checkbox"/>
--------------------------	--------------------------	--------------------------	--------------------------	--------------------------	--------------------------

mm /

**Mail to: / Posterie**  
LEGO Club, P.O. Box 1157  
Enfield, CT USA 06083-1157

**Mail to:**  
LEGO Club, 33 Both Road  
Slough SL1 3UF U.K.

**Per Post an:**  
LEGO Club, Postfach 1415  
D-36243 Niederried

The LEGO Group is not responsible for any loss of data or information. The LEGO Group does not warrant the accuracy of any information provided. The LEGO Group is not responsible for any loss of data or information. The LEGO Group does not warrant the accuracy of any information provided. The LEGO Group is not responsible for any loss of data or information. The LEGO Group does not warrant the accuracy of any information provided.

[www.LEGOclub.com](http://www.LEGOclub.com)

00800 5346 5555  
 (en Français)

US & Canada only  
 1-866-534-6258  
 1-877-518-5346



**club**™

FREE LEGO Magazine • GRATUIT • GRATIS LEGO Magazin

**Join Today! • Abonne-toi dès aujourd'hui!**  
**Meld je nu aan! • Jetzt anmelden!**



**VISIT THE  
WORLD'S BIGGEST  
LEGO® SHOP!  
[www.LEGOshop.com](http://www.LEGOshop.com)**



1x  
4222192

1x  
4210985

2x  
4211055

3x  
4211051

4x  
4210636

1x  
4210631

4x  
4521185

2x  
4212529

1x  
4211048

1x  
4289542

1x  
4210698

1x  
4529240

1x  
4500608

1x  
4211010

1x  
4211086

2x  
4520307

19x  
4211060

1x  
4211080

1x  
4210781

1x  
4210780

1x  
4521886

4x  
4535833

1x  
4243831

1x  
4211115

4x  
4500517

1x  
4211114

1x  
4211122

1x  
4211067

2x  
4210796

1x  
4516458

1x  
4288824

2x  
403228

1x  
618844

2x  
3005744

1x  
611644

1x  
4194746

1x  
618841

6x  
3000841

1x  
4244363

1x  
3005741

1x  
618848

2x  
4217436

1x  
4244573

1x  
3005748

3x  
300426

2x  
300326

1x  
4163904

2x  
4113241

5x  
300126

2x  
242026

1x  
317626

2x  
4163544

2x  
408326

2x  
614026

1x  
4144567

1x  
4517986

1x  
4509865

1x  
4279270

1x  
256926

1x  
4287672

4x  
73587

1x  
383526

1x  
396226

6x  
459926

4x  
4140588

2x  
4100530

1x  
371026

1x  
241226

2x  
303926

2x  
4273703

3x  
368026

1x  
4526110

2x  
4113233

1x  
414001

1x  
4211413

1x  
4211508

3x  
4211439

6x  
4211479

1x  
4211369

4x  
4244627

12x  
4211505

1x  
4512360

1x  
4211370

1x  
4255629

1x  
4515351

2x  
4211404

4x  
4221602

1x  
4528624

Customer Service  
Kundenservice  
Service Consommateurs  
Servicio Al Consumidor

[www.lego.com/service](http://www.lego.com/service) or dial

00800 5346 5555  
1-800-422-5346



7731

7732

7733





7734



**LEGO** **BATMAN**<sup>TM</sup>  
THE VIDEOGAME

COMING SEPTEMBER 2008

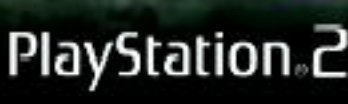











LEGO, the LEGO logo, the minifigure, and the Brick and Knob trademarks are trademarks of the LEGO Group. © 2008 The LEGO Group. All rights reserved.  
LEGO BATMAN™ THE VIDEOGAME™ is a trademark of Warner Bros. Entertainment Inc.™. DC™, BATMAN™, ROBIN™, and the DC logo are trademarks of DC Comics.™. All other trademarks are the property of their respective owners. Visit www.esrb.org for rating information.



7235



7236



7245



7741



7743



7744



## WIN LEGO® PRODUCTS

No purchase necessary.  
Open to residents of all countries where  
not prohibited.  
Go to [www.](http://www.) for official rules and details.

## WIN LEGO® PRODUCTEN

Kopen niet nodig.  
Open voor alle leeftijden, en in alle landen  
waar geen verbod geldt.  
Ga naar [www.](http://www.) voor officiële regels en details.

## GEWINNE LEGO® PRODUKTE

Die Teilnahme am Gewinnspiel führt zu  
keinerlei Kaufverpflichtungen.  
Sie können in allen nicht ausgeschlossenen  
Ländern teilnehmen.  
Die offiziellen Regeln und nähere Informationen  
finden Sie unter [www.](http://www.)

## GAGNE DES PRODUITS LEGO®

Aucun achat n'est nécessaire.  
Ouvert à tous les âges et aux résidents de  
tous les pays, sauf en cas d'interdiction.  
Rendez-vous sur [www.](http://www.) pour obtenir plus  
de détails et le règlement officiel.

## レゴ®製品を「当てよう」

購入は不要です  
禁止されていない限り、あらゆる  
年代およびあらゆる国の居住者の  
方々にご利用いただけます。  
公認規則および詳細につきましては、  
[www.](http://www.)をご覧ください



WIN  
WIN  
GEWINNE  
GAGNE  
「当てよう」

