

BenQ DC E720

Digital Camera User Manual

Welcome

Copyright

Copyright 2006 by BenQ Corporation. All rights reserved. No part of this publication may be reproduced, transmitted, transcribed, stored in a retrieval system or translated into any language or computer language, in any form or by any means, electronic, mechanical, magnetic, optical, chemical, manual or otherwise, without the prior written permission of this company.

Disclaimer

BenQ Corporation makes no representations or warranties, either expressed or implied, with respect to the contents hereof and specifically disclaims any warranties, merchantability or fitness for any particular purpose. Further, BenQ Corporation reserves the right to revise this publication and to make changes from time to time in the contents hereof without obligation of this company to notify any person of such revision or changes.

Taking care of your camera

- Do not use your camera in the following environmental range: temperature below 0°C or above 40°C.
- Do not use or store your camera in the environments listed below:
 - Direct sunlight
 - High and dusty places
 - Next to an air conditioner, electric heater or other heat sources
 - In a closed car that is in direct sunlight
 - Unstable locations
- If your camera becomes wet, wipe it with a dry cloth as soon as possible.
- Salt or seawater may cause severe camera damage.
- Do not use solvents, such as alcohol, to clean your camera.
- If the lens is dirty, use a lens brush or soft cloth to clean the lens. Do not touch the lens with your fingers.
- To prevent electric shock, do not attempt to disassemble or repair your camera by yourself.
- Water may cause a fire or electric shock. Therefore, store your camera in a dry place.
- Do not use your camera outdoors when it is raining or snowing.
- Do not use your camera in or near water.
- If a foreign substance or water gets in your camera, please turn the power off immediately and remove the batteries. Remove the foreign substance or water, and send it to the maintenance center.
- Transfer the data to the computer as soon as possible to avoid losing your images and / or video clips.

Disposal of Waste Electrical and Electronic Equipment by users in private households in the European Union.



This symbol on the product or on the packaging indicates that this can not be disposed of as household waste. You must dispose of your waste equipment by handing it over to the applicable take-back scheme for the recycling of electrical and electronic equipment. For more information about recycling of this equipment, please contact your city office, the shop where you purchased the equipment or your household waste disposal service. The recycling of materials will help to conserve natural resources and ensure that it is recycled in a manner that protects human health and environment.

CE Regulatory Notice

Hereby, BenQ Corp. declares under our responsibility that the product is in conformity with the requirements set out in the Council Directive on the Approximation of the Laws of the Member States relating, Electromagnetic Compatibility Directives (89/336/EEC, 92/31/EEC) and Low Voltage Directive (73/23/EEC).

Table of Contents

1. Touring Your Camera	1
1.1 Checking the package contents.....	1
1.2 Camera components	1
1.2.1 Front view	1
1.2.2 Rear view.....	2
1.2.3 LED indicators	3
2. Preparing Your Camera for Use	4
2.1 Installing the Battery	4
2.2 Charging the Battery	5
2.3 Inserting and removing an SD memory card.....	5
3. Using the Camera	7
3.1 Navigator	7
3.2 LCD monitor information (REC mode)	7
3.3 Getting started.....	8
3.3.1 Turning the power on / off	8
3.3.2 Choosing the screen language	8
3.3.3 Setting the date and time	8
3.3.4 Snapshot mode.....	8
3.3.4.1 Getting started with capturing images	8
3.3.5 Using the flash.....	9
3.3.6 Using the self-timer and burst	9
3.3.7 Using the zoom function	10
3.4 Menu options.....	10
3.4.1 Changing the mode	10
3.4.1.1 Switching between REC mode and PLAY mode .	10
3.4.1.2 Selecting the Scene mode	11
3.4.2 Using the menus	12
3.4.2.1 REC menu list (still image)	12
3.4.2.2 REC menu list (movie)	13
3.4.3 Setup menu	13
3.4.3.1 Setup menu list	13

3.5	Recording movie clips	14
3.6	Recording audio clips	15
3.7	Other recording functions	15
3.7.1	Setting the quality	15
3.7.2	Setting the metering	15
3.7.3	Setting the white balance	16
3.7.4	Setting the ISO	16
3.7.5	Setting the Exposure	16
3.7.6	Setting the AEB	16
3.7.7	Setting the highlight	17
3.7.8	Setting the sharpness	17
3.7.9	Setting the photo effect	17
3.7.10	Setting the date stamp	17
3.7.11	Setting AF lamp	17
3.8	Playback	18
3.8.1	Playing back images	18
3.8.2	Playing back movie clips	18
3.8.3	Magnifying & trimming still images	18
3.8.4	Viewing in thumbnail	19
3.8.5	Playing a slide show	19
3.8.6	Deleting a single file or all files	19
3.8.7	Setting the DPOF for printing	20
3.8.8	Other playback functions	20
4.	PC Dependent Features	21
4.1	Bundled software	21
4.2	Transferring files to your computer	21
4.2.1	Step 1: Connect the digital camera to your computer	22
4.2.2	Step 2: Download images or video clips	22
5.	Troubleshooting	23
6.	Specifications	25
7.	Service Information	26

1 Touring Your Camera

1.1 Checking the package contents

Carefully unpack your kit box and ensure that you have the following items.

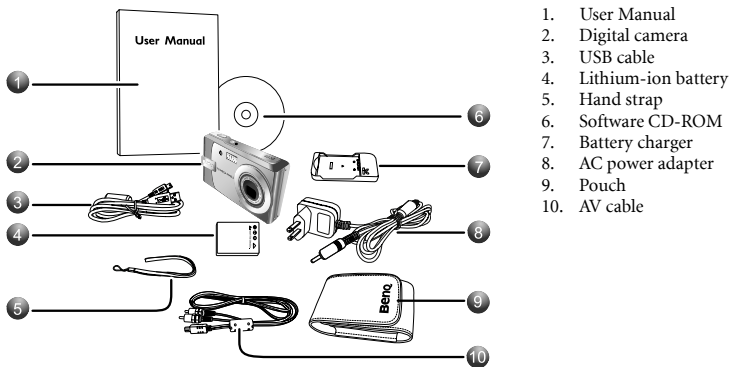

If any of the items are missing or appear to be damaged, contact your dealer. Save the packaging in case you need to ship your camera for service.

1.2 Camera components

1.2.1 Front view

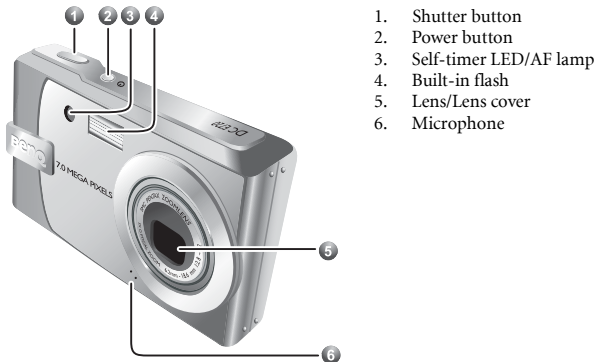

1.2.2 Rear view

1. LCD monitor
2. Status LED
3. **W**
4. **T**
5. Zoom-out or thumbnail
6. **T**
7. Zoom-in
8. PLAY mode
9. Menu
10. Navigator -- four-way control and OK
11. MODE button
12. Delete button
13. Speaker
14. Tripod mount
15. Battery/SD memory card cover
16. Strap eyelet
17. PC (USB) / AV Out terminal

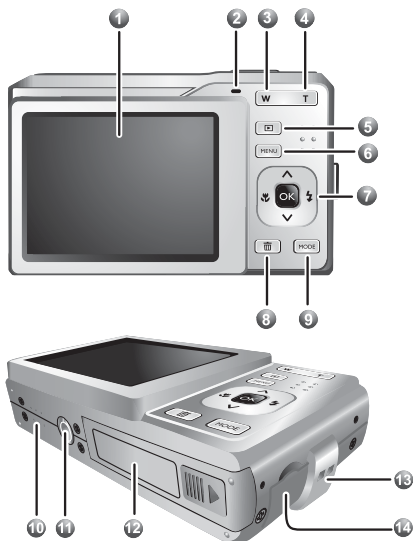

1.2.3 LED indicators

Indicator	State	Description
Status LED	No light	The digital camera is powering off.
	Solid green	The digital camera is ready to capture images or record video clips.
	Blinking green	The digital camera is powering on, cannot focus, or is in the power-saving mode.
	Blinking red	The camera/flash is charging, or the USB communication/transfer is in progress.
Self-timer LED	Blinking red	The self-timer function is activated.



- The LCD on the digital camera is manufactured with sophisticated technology; however, the display may have some light spots or show unusual colors. This is normal and does not indicate display malfunction, nor will this affect the pictures you take with the camera.
- When the camera is in the power-saving mode, the LCD monitor goes blank. You can press any button to resume operation.

It is normal for the camera to become warm during operation, because metal camera casing can conduct heat.

2 Preparing Your Camera for Use

2.1 Installing the Battery

We highly recommend that you use only the specified rechargeable lithium-ion battery for your camera. Make sure that the power of the camera is off before inserting or removing the battery.

To insert the battery:

1. Open the battery/SD memory card cover (A).
2. Insert the battery in the correct direction shown (B).
3. Push the battery all the way down, until the battery lock lever clicks into place (C).
4. Close the battery/SD memory card cover (D).

To remove the battery:

1. Open the battery/SD memory card cover.
2. Release the battery lock lever.
3. When the battery has come out a little, gently pull it out the rest of the way.



2.2 Charging the Battery

The battery charge status affects the performance of the camera. To maximize the performance and life of the battery, it is recommended that you fully charge the battery using the specified charger set (charger and AC power adapter), and then fully discharge it through the normal use at least one time. Make sure that the power of the camera is off before inserting the battery.

1. Insert the battery into the charger as shown in the illustration.
2. Connect one end of the AC power adapter to the charger.
3. Connect the other end of the AC power adapter to a wall outlet.
4. When the battery is being charged, the charger LED indicator lights up in red. When the battery is fully charged, it turns into green.

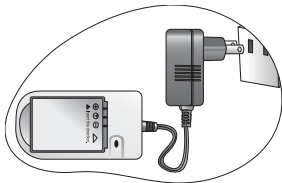

The length of the charging time depends on the ambient temperature and the status of the battery.

- ☞ **The camera must be used with the specified charger set. Damage caused by the use of an incorrect charger set is not covered under the warranty. Always make sure that the camera is off before removing the battery.**
- **The battery may be warm after being charged or used. This is normal and not a malfunction.**
- **When using the camera in cold environments, keep the camera and its battery warm by holding it inside your jacket or other warm protective environment.**

2.3 Inserting and removing an SD memory card

The camera is equipped with internal memory, allowing you to record video clips and capture images. You can also expand the memory capacity by using an optional SD (Secure Digital) memory card to store more files.

1. Always make sure the camera is turned off before inserting or removing a memory card.
2. Insert an SD memory card in the correct orientation as shown in the illustration.
3. Close the battery / SD memory card cover.



To remove the SD memory card, make sure the camera is turned off. Press lightly on the edge of the memory card and it will eject.

- Be sure to format the SD memory card with this camera before the initial use.
- To prevent valuable data from being accidentally erased from an SD memory card, you can slide the write-protect tab (on the side of the SD memory card) to "LOCK".
- To save, edit, or erase data on an SD memory card, you must unlock the card.
- SD memory card in the following sizes are supported: 64 MB, 128 MB, 256 MB, 512 MB, 1 GB, and 2 GB. The camera is compatible with SD memory cards manufactured by Panasonic, Toshiba, and Sandisk. Please contact your local dealer for purchase information.

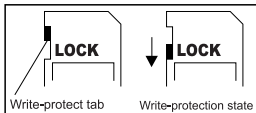

3 Using the Camera

3.1 Navigator

You can use the Navigator with four-way control and one **OK** button to access numerous controls of your camera.

1. Up ▲ or Play video/voice REC
2. Focus mode or left ◀
3. Down ▼
4. Flash mode or right ▶
5. OK

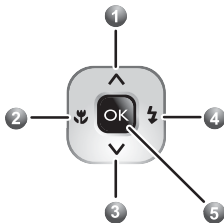

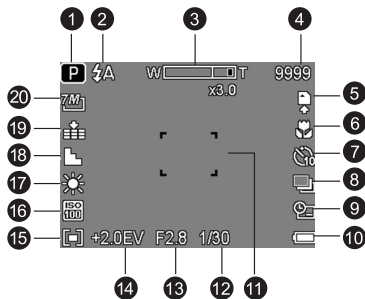

3.2 LCD monitor information (REC mode)







- | | |
|---------------------|--------------------|
| 1. Scene mode | 11. Focus area |
| 2. Flash | 12. Shutter speed |
| 3. Zoom indicator | 13. Aperture value |
| 4. Shots remaining | 14. Exposure |
| 5. Storage media | 15. Metering |
| 6. Macro | 16. ISO |
| 7. Self-timer/Burst | 17. White Balance |
| 8. AEB | 18. Sharpness |
| 9. Date stamp | 19. Quality |
| 10. Battery | 20. Resolution |

3.3 Getting started









3.3.1 Turning the power on / off

- Press the [] button until the digital camera turns on. Or, you can press the [] button when the camera is off to turn on the camera.
- To turn the power off, press the [] button again.

3.3.2 Choosing the screen language

1. Press **MENU**, and then press [] / [] to move to the Setup menu.
2. Press **OK**.
3. Press [] or [] to move to **Language**, and then press [] or **OK** to select the language you want.
4. Press **OK**.

3.3.3 Setting the date and time

1. Press **MENU**, and then press [] / [] to move to the Setup menu.
2. Press **OK**.
3. Press [] or [] to move to **Date & Time**, and then press [] or **OK**.
4. Press [] / [] to select Year, Month, Day, Time, and Format fields.
 - To increase a value, press [].
 - To decrease a value, press [].
 - The time is displayed in 24 hour format.
5. Press **OK**.



3.3.4 Snapshot mode

3.3.4.1 Getting started with capturing images

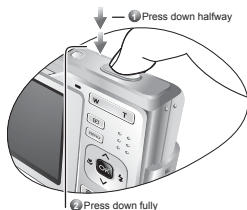
1. Press the [] button for more than one second to turn on the camera.
2. Compose your image in the LCD monitor under Snapshot Mode.
3. Press the shutter button down halfway (1), and then press it down fully (2).
 - Pressing the shutter button down halfway automatically focuses and adjusts the exposure.







- The focus area frame turns green when the camera is focused and the exposure is determined.
- When the focus or exposure is not suitable, the frame of the focus area turns red.

-  • **To review the last captured image, press the  button. Press the  button to return to Snapshot mode.**
- **The LCD monitor darkens in strong sunlight or bright light. This is not a malfunction.**
 - **To prevent your images from being blurred while pressing the shutter button, always hold the camera steady. This is especially important when you are shooting under low lighting conditions, under which your camera may reduce the shutter speed to ensure your images are properly exposed.**

3.3.5 Using the flash

The flash is not only for taking pictures when there is insufficient light, but also when the subject is in shade or in backlight conditions. Pressing the flash button cycles your camera through the various flash modes. The flash will not activate when continuous shooting or movie recording.





1. Turn the power on, and set the camera to the REC mode.
2. Pressing the flash button changes the flash mode. Each time the flash button is pressed, the flash icon changes.
3. Press the shutter button to take a picture.

Icon	Flash mode	Description
	Auto flash	Flash fires automatically when shooting conditions require extra lighting.
	Red-eye reduction	Flash strobos to let the subject eyes adjust to the flash, then fires again to take the actual image. Your camera will detect the subject brightness and use the flash only when required.
	Force on	Flash fires every time you take a photo, regardless of lighting conditions.
	Slow sync	Flash fires with a slow shutter speed.
	Force off	The flash never fires even in dark situation.

3.3.6 Using the self-timer and burst

Use the self-timer to set a delay from the time the shutter button is pressed to the time the image is shot. Use the burst to record continuous still images shooting.

1. Turn the power on, and set the camera to the REC mode.
2. Open the REC menu. Use [◀] / [▶] to select **Drive mode** from the REC menu.
3. Change the setting. Press [▲] / [▼] to select a drive mode, then press **OK**.
4. Press the shutter button to take a picture.

Icon	Flash mode	Description
	Off	Record a single image.
	2 sec.	The shutter release will be delayed for 2 seconds.
	10 sec.	The shutter release will be delayed for 10 seconds.
	Double	Record two images in a shot after pressing the shutter release button 10 and 12 seconds.
	Burst	Keep pressing the shutter button fully to take a continuous shooting. Release the shutter button to stop shooting.

3.3.7 Using the zoom function

Your camera has a combination of optical and digital zoom functions that allows you to zoom in on far away subjects or zoom out for a wide angle shot.

The optical zoom is achieved by mechanically adjusting the lens of the camera. The digital zoom enlarges or shrinks the image using a software process.

1. Make the zoom setting, and point the camera at the subject.
2. Press the zoom button (**W/T**) to compose the image.
 - [W]: zoom out for a wide-angle shot.
 - [T]: zoom in for a telephoto shot.
 - When the zoom button is pressed, the zoom bar appears on the LCD monitor.
 - When the optical zoom factor is at maximum, zooming stops temporarily. Press the [T] again, the camera switches to the digital zoom automatically and zooming continues.
 - You can use optical zoom in movie recording.
3. Press the shutter button to take a picture.

3.4 Menu options

3.4.1 Changing the mode















You can record images and voices in the REC mode. And using the PLAY mode to replay, delete, or edit images on the LCD monitor.

3.4.1.1 Switching between REC mode and PLAY mode

- In REC mode, press the PLAY button to switch to the PLAY mode.
- In PLAY mode, press the PLAY or the MODE button to switch to the REC mode.

3.4.1.2 Selecting the Scene mode

1. Set the camera to the REC mode.
2. Press the **MODE** button to show the scene mode palette.
3. Use the four-way control to select a desired mode and press **OK** to confirm the setting.

Icon	Mode	Description
	Program	The camera makes settings suitable for the shooting conditions.
	Movie	For recording movie clips.
	Voice REC	For recording audio.
	Sunset	Enhance the red hue for recording sunset images.
	Backlight	Shooting the image of backlight object by changing metering.
	Shake-Free	Reduce blur caused by camera vibration.
	Landscape	Used for the wide scenic views.
	High ISO Portrait	Use a higher ISO value to make people stand out with the background out-of-focus even in a dark environment.
	Snow	Used for the beach or snow scenes.
	Fireworks	Slow shutter speed to take fireworks exploding.
	Night Scene	Shooting the subject while keeping the background night scenery.
	Kids	Take a still image to capture moving kids.
	Food	Higher saturation makes food more appetizing.
	Building	Enhance the edges of the subject.
	Text	Enhance the black & white contrast.



































 • The higher the ISO value, the grainer you may see in the image.

3.4.2 Using the menus













When a menu is displayed, the four-way control and the **OK** button are used to make the desired settings.

1. Turn the power on, and set the camera to the REC mode.
2. Press the **MENU** button to display the menu.
3. Press [◀] / [▶] to select a menu item.
4. Press [▲] / [▼] to change the setting.
5. Press the **MENU** or the **OK** button to save the settings and close the menu.

3.4.2.1 REC menu list (still image)

Menu item	Available settings
Resolution	 /  /  /  /  /  / 
Quality	 /  / 
Metering	 /  / 
White Balance	Auto /  /  /  /  /  / 
ISO	Auto /  /  /  / 
Exposure	-2.0 EV ... +2.0 EV
Drive Mode	Off /  /  /  / 
AEB	Off / 
Highlight	Off /  /  / 
Sharpness	 /  / 
Effect	Off / B&W / Sepia / Negative / Red / Green / Blue
Date Stamp	Off / Date / Date & Time
Digital Zoom	Off / On
AF lamp	Off / On

3.4.2.2 REC menu list (movie)

Menu item	Available settings
Movie Size	 /  / 
Metering	 /  / 
White Balance	Auto /  /  /  /  /  / 

3.4.3 Setup menu

1. Turn the power on, and set the camera to the REC or PLAY mode.
2. Press the **MENU** button to open the REC or PLAY menu. The menu displays depend on whether you are in the REC mode or the PLAY mode.
3. Press the four-way control to select **Setup: Enter** and then press the **OK** button to display the Setup menu.
4. Press [**▲**] / [**▼**] to select a menu item and then press [**▶**] or the **OK** button to launch the submenu.
5. Press [**▲**] / [**▼**] to select an option and press the **OK** button to apply the setting.
6. Press the **MENU** button to close the menu.

3.4.3.1 Setup menu list

Menu item	Functions	
Sounds	[Shutter]	Sets the shutter sound on and off.
	[Start-up]	Sets a type of the start-up sound.
	[Beep]	Sets the operation sound on and off.
	[Volume]	Adjusts the volume of the shutter sound, start-up sound, beep and playback sound.
Auto Review	[Off]	The captured image will not automatically display after shooting.
	[3 sec.]	The captured image will display for 3 seconds after shooting.
	[5 sec.]	The captured image will display for 5 seconds after shooting.
Power Save	[1 min.]	For power consumption, the camera is turned off automatically for a period of time.
	[3 min.]	
	[5 min.]	
Date & Time	Sets the date & time.	
Language	Select a language for display menus and other information.	

Menu item	Functions	
File No.	Use this function if the camera experiences a "Folder cannot be created" error or if you want to restart numbering, for example, after erasing all files.	
	[Series]	Store the latest used file number no matter deleting files or inserting a new memory card.
	[Reset]	Reset file numbering each time the memory card is changed. Resetting the file number is useful for avoiding the file name duplication when images are downloaded to a computer.
TV Out	You can review images on a television with a supplied AV cable.  TV Out should be set to either NTSC or PAL depending on your region. For details about which system should be used, check with your local authorities.	
	[NTSC]	America, Japan, Taiwan and others
	[PAL]	Europe, Oceania and others
USB	[Computer]	Sets the USB mode to connect the camera with a printer or computer.
	[PictBridge]	
Start-up Image	Sets a recorded image as the start-up image.	
Format	To erase all data stored in the memory card if you are using a card, or all data stored in the internal memory if there is no card inserted. A "Busy...please wait" message displays and the memory card is starting format. A "Completed" message displays when finish formatting. All data will be deleted including protected files. Be sure to download important files to your computer before formatting.	
Reset All	Resets the entire menu and button operation settings to initial default. The following settings do not change after Reset All: Date & Time setting Language setting TV out setting	

3.5 Recording movie clips

- Turn the power on, and set the camera to the Movie mode.
- Compose the subject on the monitor.
 - Aim the focus area to the subject that you want to take.
 - The LCD monitor displays the available recording time
- Start recording.
 - Press the shutter button to start recording.



- Using the zoom button to adjust the image size.
 - The White Balance is set and locked to the settings of the first frame.
-  • **Sound cannot be recorded while pressing the zoom button.**
- **You can use optical zoom in movie recording.**
4. Finish recording.
 - Press the shutter again to end recording.
 - The camera will stop recording automatically when the memory capacity has been reached.

3.6 Recording audio clips

1. Turn the power on, and set the camera to the Voice REC mode.
2. Press the shutter button to start recording.
 - The voices are recorded from the microphone of the camera. Be careful to avoid touching the microphone while recording.
3. Press the shutter button again to end recording.
 - The camera will stop recording automatically when the memory capacity has been reached.



3.7 Other recording functions

3.7.1 Setting the quality

Compression		Purpose
	Super Fine	Shoot higher quality images.
	Fine	Shoot normal quality images.
	Normal	Shoot for more images.







3.7.2 Setting the metering

There are 3 different light metering options available on your camera.

Icon	Mode	Description
	Center	Light is measured from the entire shooting screen, but gives more importance to the values near the center.
	Multi	Selects an exposure based on readings from multiple points in the subject area
	Spot	Selects an exposure based on a single reading taken from the center of your picture.

3.7.3 Setting the white balance

Adjust the white balance to match different light sources such as sunlight, incandescent (tungsten) lighting or, fluorescent lighting.

Icon	Mode	Description
	Auto	Automatically corrects white balance. Ideal for general photography.
	Daylight	Adjusts for bright sun conditions, or natural light conditions.
	Cloudy	Adjusts for cloudy days or twilight conditions.
	Tungsten	Adjusts for normal indoor lighting conditions. Corrects the orange hue of household light bulbs. Ideal for indoor photos under tungsten or halogen lighting without a flash.
 	Fluor_H Fluor_L	Adjusts for fluorescent lighting. Corrects the green hue of fluorescent lighting. Ideal for indoor photos under fluorescent lighting without a flash.
	SH1 (Custom)	For more accurate adjustment or when the light source cannot be specified. When this option is highlighted, press the shutter button to enter the [Custom WB] mode. Then, point the camera at something white (for example, white paper) as the reference white color and press the shutter button again. Next, press OK to confirm the custom setting.

3.7.4 Setting the ISO

With the initial settings, the ISO sensitivity is automatically set according to the brightness of the subject.

- **A higher ISO value increases the image noise. To take clean images, use an ISO value as low as possible.**



3.7.5 Setting the Exposure

Set the exposure value manually to compensate for unusual lighting conditions such as indirect indoor lighting, dark backgrounds, and strong backlighting.

3.7.6 Setting the AEB



Sets the auto exposure bracketing (AEB) to shoot 3 continuous images, each with a different exposure setting: correctly exposed, underexposed, and overexposed.

3.7.7 Setting the highlight

Make the subject stand out from its surroundings. The subject will be in focus in three different ranges:  /  / .

3.7.8 Setting the sharpness

You can select whether you want the image to have sharp or soft outlines.

Icon	Mode	Description
	Hard	The edges of the image are emphasized. The edges will become sharp, but noise may occur in the recording image.
	Normal	The edges of the image are sharp. This is suitable for printing.
	Soft	The edges of the image are softened. This is suitable for editing images on PC.

3.7.9 Setting the photo effect

You can add special effects to your images in REC or PLAY mode.

Icon	Description
Off	No effect is added to the image.
B&W	Convert image to black & white.
Sepia	Recorded image will be stored in a sepia tone.
Negative	Opposite what they were in the original image.
Red	The image becomes reddish.
Green	The image becomes greenish.
Blue	The image becomes bluish.

3.7.10 Setting the date stamp

The Date Stamp function can be used to add a date to your pictures as you take them.

3.7.11 Setting AF lamp

The AF Lamp function allows you to record images in low light conditions.

Option	Description
Off	Disables the AF lamp while recording images.
On	Turns on the AF lamp while pressing the shutter button down halfway.

3.8 Playback

3.8.1 Playing back images

1. Turn the power on, and set the camera to the PLAY mode.
 - The latest recorded image appears on the LCD monitor.
 - If there are no images stored, a message **[No image]** appears.
2. Press the four-way control.
 - [◀] displays the previous image.
 - [▶] displays the next image.

 • Holding down [◀] or [▶] scrolls images in a high speed.

3.8.2 Playing back movie clips

1. Turn the power on, and set the camera to the PLAY mode.
2. Press [◀] or [▶] to select a movie clip that you want to playback.
3. Start playing back.
 - Press [▲] to start playing the movie clip.
 - Press [▼] to stop the movie clip, or press [▲] to pause it. When the movie paused, press [▲] again to resume.

 • During movie playing back, press [▶] to fast forward or press [◀] to rewind it.
• Press the shutter to capture the still image from the movie clip while it had paused.

3.8.3 Magnifying & trimming still images

1. Turn the power on, and set the camera to the PLAY mode.
2. Select an image.
 - Press [◀] or [▶] to select the image that you want to magnify or trimming.
 - Only still images can be magnified and trimmed.
3. Magnify the image.
 - Press [T] to magnify the image, and the central portion of the image is displayed. You can use the arrow button to view different parts of the magnified image.
 - Press the **MENU** button to return to the normal size.
4. Trim the image.
 - Press the **OK** button to set the image trimming.
5. Save the image.
 - Press the **OK** button again to trim the selected image and save it as a new one.

3.8.4 Viewing in thumbnail

1. Turn the power on, and set the camera to the PLAY mode.
2. Press the zoom button [W], a thumbnail screen is displayed.
3. Use the four-way control to select the desired image, and press [T] or the OK button to show the selected image in full screen.





3.8.5 Playing a slide show

1. Turn the power on, and set the camera to the PLAY mode.
2. Enter the slide show.
 - Press the MENU button and use the four-way control to select Slide Show and press the OK button
3. Change the slide show settings.
 - Use the four-way control to set the slideshow interval (🕒), music (🔊), effect (🎨) and repeat (🔄).
 - You can set the interval between 1~10 seconds.
4. Playing the slide show.
 - Press the OK button to start the slideshow.
 - During the slide show, press the OK button to pause the slideshow and press the OK button again to resume.





3.8.6 Deleting a single file or all files

1. Turn the power on, and set the camera to the PLAY mode.
 2. Open the menu.
 - Press the MENU button, then use the four-way control to select Delete  and press the OK button.
 3. Press [▲] or [▼] to select [Single], and then press the OK button.
 - To delete all images, select [All] and press the OK button twice.
 4. Press [◀] or [▶] to select the image you want to delete.
 5. Press the OK button to delete the image.
 - Repeat step 4~5 to delete images.
-  **To quickly delete the current display image:**
1. Select the image you want to delete.
 2. Press the Delete button to show a confirmation.
 3. Press the OK button to delete the current display image.
- Protected images cannot be deleted with this function.

3.8.7 Setting the DPOF for printing

The Digital Print Order Format (DPOF) setting allows you to select images on the memory card for printing and specify the number of print copies in advance using the camera. This is extremely convenient for sending the images to a photo developing service or for printing on a direct print function compatible printer.

- Turn the power on, and set the camera to the PLAY mode.
- Open the menu.
 - Press the **MENU** button, then use the four-way control to select **DPOF**  and press the **OK** button.
- Press [▲] or [▼] to select **[Single]**, then press the **OK** button.
 - To set the DPOF setting for all images in a time, select **[All]** in this step.
 - To reset all DPOF settings to initial default, select **[Reset]** in this step.
- Press [◀] or [▶] to select the image you want to print out, then press the **OK** button.
- Set the number of copies.
 - Press [◀] or [▶] to specify the number of copies.
 - The number of copies can be set from 0 to 30.
 - To cancel this image DPOF setting, set the number of copies to 0.
- Print the date stamp  out.
 - Press [▼] and then press [◀] or [▶] to set or cancel the date stamp of current image.
 - Repeat step 4~6 to other images for printing.
- Press [▼] and then press the **OK** button to apply the setting or press the **MENU** button to cancel.
- After you finished all image settings, select  and press the **OK** button to apply it.

3.8.8 Other playback functions

You can also protect (lock) images from being deleted, edit images, copy files, or enter setup for more options. To do so, press the **MENU** button in the PLAY mode, and select a function.



4 PC Dependent Features

4.1 Bundled software

The camera is supplied with the following software. To install the software, refer to the information supplied with respective CDs.

Ulead Photo Express

Ulead® Photo Express™ 5.0 SE is a complete photo project software for digital images. Acquire photos effortlessly from digital cameras or scanners. Edit and enhance images using easy-to-use editing tools and cool photographic filters and effects. Assemble creative photo projects and share results via e-mail and multiple print options.

Ulead Photo Explorer

Ulead® Photo Explorer™ 8.0 SE Basic provides an efficient way to transfer, browse, modify and distribute digital media. It is an all-in-one tool for owners of digital cameras, webcams, DV camcorders, scanners, or for anyone who strives to effectively handle digital media.

4.2 Transferring files to your computer

After using USB cable to establish a USB connection between the camera and your computer, you can use your computer to share captured images or recorded video clips with your family or friends via e-mail or post them on the Web. Note that before you begin, you need to check your system according to the table as shown below.

	System Requirements (Windows)
CPU	Pentium III 600 MHz processor or higher
Operating System	Windows Me / 2000 / XP
RAM	64 MB RAM or above
Hard Disk Space	128 MB hard disk space
Required Devices	A CD-ROM drive An available USB port
Display	Color Monitor (800 x 600, 24-bit or higher recommended)

4.2.1 Step 1: Connect the digital camera to your computer

1. Connect the supplied USB cable to the computer USB port and turn on the camera.
2. The LCD screen turns off when the connection to the computer has been successfully completed.

4.2.2 Step 2: Download images or video clips

When the digital camera is turned on and connected to your computer, it is considered to be a disk drive, just like a floppy disk or CD. You can download (transfer) images by copying them from the “Removable Disk” to your computer hard drive.

Windows

Open the “Removable Disk” and double-click on the DCIM folder to open it to find more folders. Your images are inside these folder(s). Select the desired still images or video clips, and then choose “Copy” from the “Edit” menu. Open the destination location (folder) and choose “Paste” from the “Edit” menu. You may also drag and drop image files from the digital camera to a desired location.



- **Memory card users may prefer to use a memory card reader (highly recommended).**
- **Video playback application is not included with the package. Make sure that video playback application has been installed in your computer.**

5 Troubleshooting

Refer to the symptoms and solutions listed below before shipping your camera for service. If the problem persists, contact your local reseller or service center.

Symptom	Cause	Solution
The camera cannot be powered up.	There is no battery or the battery is not inserted correctly.	Insert the battery correctly.
	The battery has no power.	Recharge the battery.
The battery power is draining quickly.	The external temperature is extremely low.	—
	Many shots are being captured in dark places, requiring a flash.	—
	The battery was not fully charged. The battery has not been used for an extended period of time after being charged.	Fully charge the battery and discharge it for at least one complete cycle before use.
The battery or camera is warm.	The camera or flash was used continuously over a long period of time.	—
The flash does not fire. The flash does not recharge.	The camera flash is turned off.	Set the flash to Auto Flash.
	The light source is sufficient.	—
	The flash is not available in some modes.	—
Even though the flash fired, the image is dark.	The distance to the subject is greater than the flash's effective range.	Get closer to the subject and shoot.
The image is too bright or too dark.	The exposure is excessive or inadequate.	Reset exposure compensation.
I cannot format a memory card.	The memory card is write-protected.	Remove the write protection.
	End of the memory card life.	Insert a new memory card.
I cannot download images.	The free space on the hard disk of your computer is insufficient.	Ensure that the hard disk has enough space for running Windows and that the drive for loading image files has free space equal to or greater than the memory card in the camera.
	There is no power being supplied to the camera.	Recharge your batteries or replace with new batteries if necessary.

Symptom	Cause	Solution
The camera does not shoot even when pressing the shutter button.	The battery is running low.	Recharge your batteries or replace with new batteries.
	The camera is not in Shooting Mode.	Switch to Shooting Mode.
	The shutter button was not pressed all the way down.	Press the shutter button all the way down.
	The internal memory or memory card does not have any free space.	Load a new card or delete unwanted files.
	The flash is recharging.	Wait until the flash mode icon, indicated on the screen, stops flashing.
	The camera does not recognize the memory card.	Format the memory card before the initial use or before using with another camera.
Colors of the images taken are not shown properly.	White Balance was not set properly when these images were taken.	Select a suitable White Balance setting before taking each picture.
After connecting the camera to a computer, an error message "Device not ready" or "Camera not ready" appears.	The computer runs on Windows 98 or earlier.	—
When connecting the camera to a computer, the computer freezes.	The memory card inside the camera may not be formatted.	Format the memory card to the FAT16 format using a card reader in Windows.
A memory error occurs.	The memory card may not be formatted correctly.	Re-format the memory card to the FAT16 format using a card reader in Windows.

6 Specifications

Image Sensor	7.0 Mega Pixels CCD, Size: 1/2.5 inch
Image Resolution	3072 x 2304(7M) / 3072 x 2048 (3:2) / 3072 x 1728 (16:9) / 2560 x 1920 (5M) / 2048 x 1536 (3M) / 1024 x 768(1M) / 640 x 480(VGA)
Lens	f = 6.2 (W) ~ 18.6 (T) mm, (35mm film equivalent: 37.5 ~112.5mm); F/2.8(W) ~ 5.2(T)
Zoom	Optical: 3X
	Digital: 4X
LCD	2.5" LTPS TFT LCD / 150K Dot
Dimensions / Weight	91.5 x 56 x 22.5 (19.5 thinnest part) mm / 130 g (without battery & SD card)
Power Source	Lithium-ion battery x 1
Storage Type	Built-in 9 MB SD card compatible
Focus Range	Normal: 80cm ~ Infinity
	Macro: 15cm ~ 1 m
Shutter Speed	1/2000 sec ~ 8 sec
Movie Mode	Video: 640 x 480 / 320 x 240 / 160 x 120 (30fps) Continuous recording with sound
White Balance	Auto/Daylight/Cloudy/Tungsten/Fluorescent (H)/Fluorescent (L)/MWB
Exposure	-2 ~ +2 EV (0.3EV / step)
ISO	Auto / 50 / 100 / 200 / 400
Flash	Auto/Red eye reduction/Forced on/Slow sync/Forced off
Self-Timer	2 sec./10 sec./ 10+2 sec
File Format	Still Image: JPEG (EXIF 2.2 compatible), DCF compatible, Support DPOF Video: MPEG4 / Audio: WAV
Interface	Digital output: USB 2.0
	Audio / Video output (NTSC/PAL)
Accessory	USB cable Software CD ROM User Manual Hand Strap Pouch AV Cable Lithium-ion battery Battery charger set

* Design and specifications are subject to change without notice.

7 Service Information

Technical Support

If you have any problem or question regarding the camera, you can visit the following web site for further assistance:

<http://support.BenQ.com>

For free driver updates, product information and news releases, visit the following web site:

<http://www.BenQ.com>