

# **SWITEL**

**SWISS BRAND** 

**Strahlungsarmes schnurloses DECT-/GAP-Telefon**

**Téléphone DECT/GAP sans fil, à faible rayonnement**

**Telefono cordless DECT/GAP a basse radiazioni**

**Low-radiation cordless DECT/GAP telephone**



**DC 58x**

**Bedienungsanleitung  
Mode d'emploi  
Istruzioni per l'uso  
Operating Instructions**

# ***SWITEL***

Bedienungsanleitung . . . . . 3

Mode d'emploi . . . . . 37

Istruzioni per l'uso . . . . . 71

Operating Instructions . . . . . 105

Declaration of Conformity . . . . . 140

1	Sicherheitshinweise .....	4
2	Inbetriebnahme .....	6
3	Bedienelemente .....	8
4	Einführende Informationen .....	11
5	Menüstruktur .....	13
6	Bedienung .....	17
7	Erweitern des Telefonsystems .....	28
8	Nebenstellenanlagen / Zusatzdienste .....	29
9	Technische Eigenschaften .....	31
10	Probleme .....	32
11	Pflegehinweise / Garantie .....	33
12	Stichwortverzeichnis .....	34

# Sicherheitshinweise

---

## 1 Sicherheitshinweise

Lesen Sie diese Bedienungsanleitung sorgfältig durch.

### Bestimmungsgemäße Verwendung

Dieses Telefon mit Mobilteil ist geeignet zum Telefonieren innerhalb eines Telefonnetzes. Jede andere Verwendung gilt als nicht bestimmungsgemäß. Eigenmächtige Veränderungen oder Umbauten sind nicht zulässig. Öffnen Sie das Gerät in keinem Fall selbst und führen Sie keine eigenen Reparaturversuche durch.

### Stromausfall

Bei Stromausfall kann mit diesem Telefon nicht telefoniert werden. Halten Sie für Notfälle ein schnurgebundenes Telefon bereit, welches ohne externe Stromversorgung arbeitet.

### Aufstellungsort

Der Aufstellort hat einen entscheidenden Einfluss auf einen einwandfreien Betrieb des Telefons. Vermeiden Sie Belastungen durch Rauch, Staub, Erschütterungen, Chemikalien, Feuchtigkeit, Hitze oder direkte Sonneneinstrahlung. Verwenden Sie das Telefon nicht in explosionsgefährdeten Bereichen.

Stellen Sie das Telefon nicht in die unmittelbare Umgebung von anderen elektronischen Geräten wie z. B. Fernsehgeräten, Mikrowellen, Kühlschränke usw., da es sonst zu gegenseitiger Beeinflussung kommen kann. Stellen Sie das Telefon nicht in die Nähe eines anderen Telefons. Achten Sie darauf, dass sich keine großen metallischen Gegenstände, z. B. ein Kühlschrank oder ein Spiegel, zwischen Basisstation und Mobilteil befinden. Auch Wände können Einfluss auf die Verbindung zwischen Basisstation und Mobilteil haben.

Stellen Sie das Telefon in der Nähe einer geeigneten Steckdose und in der Nähe des Telefonanschlusses auf. Achten Sie darauf, dass man über das Kabel nicht stolpern kann!



**Achtung:** Die Kabel dürfen nicht verlängert werden!

Stellen Sie das Telefon auf eine ebene und rutschfeste Fläche. Normalerweise hinterlassen die Gerätefüße keine Spuren auf der Aufstellfläche. Wegen der Vielzahl der verwendeten Lacke und Oberflächen kann es jedoch nicht ausgeschlossen werden, dass durch die Gerätefüße Spuren auf der Aufstellfläche entstehen.

Je höher die Basisstation steht (auch innerhalb eines Gebäudes), desto besser ist ihre Reichweite.

### Netzteil



**Achtung:** Verwenden Sie nur das mitgelieferte Netzteil, da andere Netzteile das Telefon beschädigen können. Sie dürfen den Zugang zum Netzteil nicht durch Möbel oder andere Gegenstände versperren.

## Aufladbare Akkus



**Achtung:** Werfen Sie Akkus nicht ins Feuer. Verwenden Sie nur Akkus des gleichen Typs! Achten Sie auf die richtige Polung! Bei verkehrter Polung der Akkus besteht beim Aufladen Explosionsgefahr.



**Achtung:** Verwenden Sie nur die vorgeschriebenen Akkus. Verwenden Sie keine Batterien. Explosionsgefahr!

## Medizinische Geräte



**Achtung:** Benutzen Sie das Telefon nicht in der Nähe von medizinischen Geräten. Eine Beeinflussung kann nicht völlig ausgeschlossen werden.

## Hörgeräte-kompatibel

Das Telefon ist mit den meisten am Markt befindlichen Hörgeräten kompatibel. Eine einwandfreie Funktion mit jedem Hörgerät kann jedoch nicht garantiert werden.

DECT<sup>1</sup>-Telefone können in Hörgeräten einen unangenehmen Brummtönen verursachen.

## Entsorgung

Wollen Sie Ihr Gerät entsorgen, bringen Sie es zur Sammelstelle Ihres kommunalen Entsorgungsträgers (z. B. Wertstoffhof). Nach dem Elektro- und Elektronikgerätegesetz sind Besitzer von Altgeräten gesetzlich verpflichtet, alte **Elektro- und Elektronikgeräte** einer getrennten Abfallerfassung zuzuführen. Das nebenstehende Symbol bedeutet, dass Sie das Gerät auf keinen Fall in den Hausmüll werfen dürfen!



### **Gefährdung von Gesundheit und Umwelt durch Akkus und Batterien!**

Akkus und Batterien nie öffnen, beschädigen, verschlucken oder in die Umwelt gelangen lassen. Sie können giftige und umweltschädliche Schwermetalle enthalten. Sie sind gesetzlich verpflichtet, Akkus und Batterien beim batterievertreibenden Handel sowie bei zuständigen Sammelstellen, die entsprechende Behälter bereitstellen, sicher zu entsorgen. Die Entsorgung ist unentgeltlich. Die Symbole bedeuten, dass Sie Akkus und Batterien auf keinen Fall in den Hausmüll werfen dürfen und sie über Sammelstellen der Entsorgung zugeführt werden müssen.



**Verpackungsmaterialien** entsorgen Sie entsprechend den lokalen Vorschriften.

<sup>1</sup> DECT: Digital Enhanced Cordless Telecommunication = Standard für kabellose Telefone.

# Inbetriebnahme

## 2 Inbetriebnahme

### Sicherheitshinweise



**Achtung:** Lesen Sie vor der Inbetriebnahme unbedingt die Sicherheitshinweise in Kapitel 1.

### Verpackungsinhalt prüfen

Zum Lieferumfang gehören:

Inhalt	DC 58X-Modell			
	DC 581	DC 582 <sup>1</sup>	DC 583 <sup>1</sup>	DC 584 <sup>1</sup>
Basisstation mit Netzteil	1	1	1	1
Ladestation mit Netzteil	-	1	2	3
Mobilteil	1	2	3	4
Telefonanschlusskabel	1	1	1	1
Akkus (AAA 1.2 V NiMH)	2	4	6	8
Bedienungsanleitung	1	1	1	1

### Mobilteil in Betrieb nehmen

#### Basisstation anschließen

Schließen Sie die Basisstation wie auf der Skizze abgebildet an. Verwenden Sie aus Sicherheitsgründen nur das mitgelieferte Netzteil.

Beachten Sie unbedingt die Ausführungen zum Aufstellungsort Seite 4.

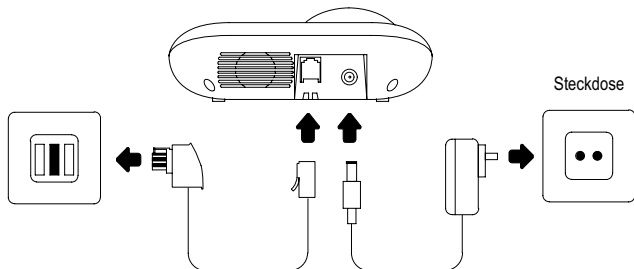

<sup>1</sup> Unter [www.switel.com](http://www.switel.com) erfahren Sie, ob dieses Telefon/Telefonset bereits erhältlich ist.



Verwenden Sie für die Basisstation das Netzteil mit den Ausgangsdaten 100-240 Vac 6 Vdc 500 mA.

## Akkus einsetzen

Das Akkufach befindet sich auf der Rückseite Ihres Mobilteils. Öffnen Sie das Akkufach und setzen Sie 2 Akkus vom Typ AAA NiMH, 1,2 V 500 mAh ein. Achten Sie auf die richtige Polung! Schließen Sie das Akkufach.

## Akkus aufladen



Stellen Sie das Mobilteil bei der ersten Inbetriebnahme für **mindestens** 8 Stunden in die Ladestation.

Haben Sie das Mobilteil richtig in die Ladestation gestellt, ertönt ein Hinweissignal. Das Mobilteil erwärmt sich beim Laden. Dies ist normal und ungefährlich. Laden Sie das Mobilteil nicht mit fremden Aufladegeräten. Der aktuelle **Akkuladezustand** wird im Display angezeigt:



Voll



Leer

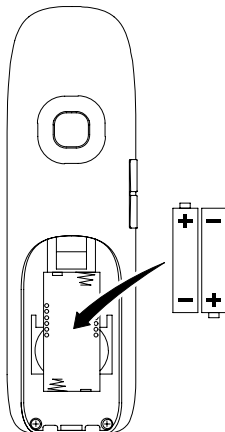

## Display-Sprache einstellen





Wählen Sie die entsprechende Sprache aus. Auf Seite 15 finden Sie die Position im Menü.

 > MT-Einstell. > Sprache >...

Es stehen 9 Sprachen zur Auswahl: Deutsch, Französisch, Italienisch, Englisch, Spanisch, Portugiesisch, Niederländisch, Polnisch und Türkisch.

## Datum und Uhrzeit einstellen

Datum und Uhrzeit stellen Sie über das Menü ein  Seite 14.

Bestätigen Sie die Eingabe von Jahr, Monat, Tag, Stunde und Minute jeweils mit der Taste . Beachten Sie das eingestellte Zeitformat  Seite 14. Ist das 12 Stunden Format eingestellt, wählen Sie mit den Tasten  /  aus, ob die eingestellte Zeit vor Mittag (A) oder nach Mittag (P) bedeutet.

## Nebenstellenanlagen

Auf Seite 29 erhalten Sie weitere Informationen, falls Sie Ihr Telefon (Ihre Basisstation) an eine Nebenstellenanlage anschließen möchten.

## Strahlungsreduzierung (ECO-Mode)

Die Strahlung wird im Vergleich zu Standard-DECT-Schnurlostelefonen im Bereitschaftsmodus erheblich verringert, wenn das Mobilteil in der Ladestation steht. Im Gesprächsmodus wird die Strahlung abhängig von der Entfernung des Mobilteils zum Telefon (zur Basisstation) verringert.



# Bedienelemente

## 3 Bedienelemente

Die Tasten werden in dieser Bedienungsanleitung nachfolgend mit vereinheitlichten umrandeten Symbolen dargestellt. Leichte Abweichungen der Tastensymbole Ihres Telefons gegenüber den hier verwendeten Tastensymbolen sind daher möglich.





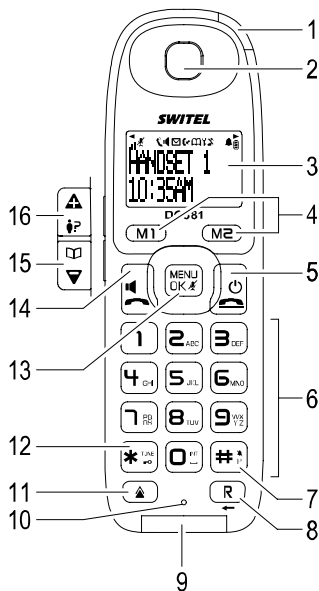





















### Mobilteil

- 1 optische Rufanzeige (Anruf-LED)
- 2 Hörmuschel
- 3 LC-Display
- 4 Direktwahltasten (M1) (M2)
- 5 Auflegetaste / Aus-Taste
- 6 Zifferntastenblock (1) (2... bis 0)
- 7 #-Taste / Rufton aus / Wahlpause (R)
- 8 R-Signal-Taste / Zurück (R)
- 9 Optische Rufanzeige
- 10 Mikrofon
- 11 Wahlwiederholung (▲)
- 12 Stern-Taste (\*)
- 13 Menü- / OK- / Stumm-Taste (MENU OK #)
- 14 Gesprächstaste / Freisprechen (☎)
- 15 Pfeil-Taste runter / Telefonbuch (▼)
- 16 Pfeil-Taste rauf / Anrufliste (▲)





## Symbole und Texte im Display des Mobilteils

Symbol	Beschreibung
	Anzeige der Akkukapazität. Leer: Die Akkus müssen geladen werden. Durchlaufende Segmente: Die Akkus werden geladen  Seite 7.
	Verbindung zur Basisstation. Je mehr Balken angezeigt werden, desto besser ist die Verbindung (maximal 3 Balken).
	Blinkend: Ein Anruf geht ein  Seite 17. Konstant: Sie führen ein Gespräch  Seite 17.
	Verpasste Anrufe. Es sind neue Anrufe in der Anrufliste  Seite 24.
	Sie befinden sich im Telefonbuch  Seite 21.
	Der Eintrag bzw. die Anzeige geht zur rechten Seite weiter  Seite 21.
	Der Eintrag bzw. die Anzeige geht zur linken Seite weiter  Seite 21.
	Der Rufton ist ausgeschaltet  Seite 20.
	Das Mikrofon ist stummgeschaltet  Seite 20.
	Das Freisprechen ist aktiviert  Seite 20.
	Die Tastensperre ist aktiviert  Seite 17.
	Der Wecker ist eingeschaltet  Seite 27.
	Anrufbeantworter im Telefonnetz. <b>VMWI</b> - Zusatzdienst Ihres Netzbetreibers  Seite 30.

# Bedienelemente

---

## Basisstation

- 1 Ladekontakte
- 2 Paging-Taste 
- 3 optische Rufanzeige (Anruf-LED)

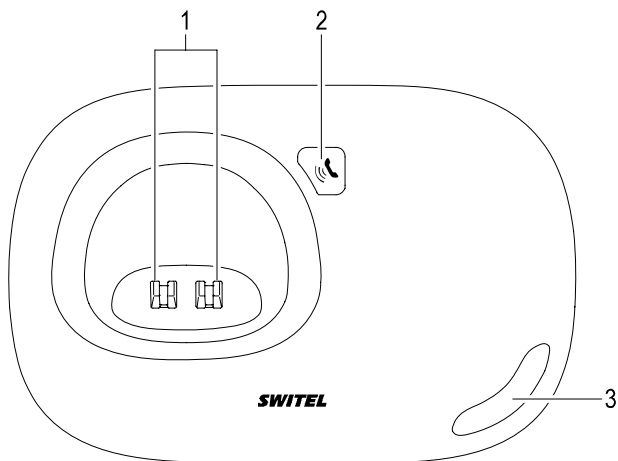

## 4 Einführende Informationen

In diesem Kapitel finden Sie grundlegende Informationen zur Handhabung der Bedienungsanleitung.

### Darstellungsweise in der Bedienungsanleitung

Darstellung	Beschreibung
	Darstellung von Tasten
	Abgebildete Taste kurz drücken
	Beliebige Taste kurz drücken
2 Sek.	Abgebildete Taste 2 Sekunden drücken
	Ziffern oder Buchstaben eingeben
	Mobilteil klingelt
	Telefon klingelt
	Mobilteil aus der Basisstation nehmen / Telefonhörer abnehmen
	Mobilteil in die Basisstation stellen / Telefonhörer auflegen
<div style="border: 1px solid black; padding: 2px;">Sprache</div>	Darstellung von Display-Texten
	Darstellung von Display-Symbolen

### Bereitschaftsmodus

Alle Beschreibungen in dieser Bedienungsanleitung gehen davon aus, dass sich Telefon (Basisstation) und Mobilteil im Bereitschaftsmodus befinden. Telefon (Basisstation) und Mobilteil sind im Bereitschaftsmodus, wenn kein Gespräch geführt wird und kein Menü geöffnet ist.

### Navigation im Menü

Alle Funktionen sind über unterschiedliche Menüs zu erreichen. Den Weg zur gewünschten Funktion entnehmen Sie der Menüstruktur Seite 13.



Jeder Vorgang wird automatisch abgebrochen, wenn innerhalb von 20 Sekunden keine Eingabe erfolgt.



Hauptmenü öffnen



Gewünschtes Untermenü auswählen



Untermenü öffnen

<sup>1</sup> Die Zifferntasten sind mit Buchstaben beschriftet. Durch mehrmaliges Drücken der entsprechenden Taste können Buchstaben, Ziffern und Sonderzeichen eingegeben werden.

# Einführende Informationen

	Gewünschte Funktion auswählen
	Funktion öffnen
	Gewünschte Einstellung auswählen
	Über Zifferntastenblock Ziffern oder Buchstaben eingeben
	Eingaben bestätigen
	Eine Ebene zurück im Menü
	Programmier- und Speichervorgänge abbrechen und in den Bereitschaftsmodus zurückkehren



Viele Eingaben, die mit Taste abgeschlossen werden, werden durch einen akustischen Signalton bestätigt.

## Telefonbucheinträge erstellen - Beispiel

Wie Sie in den Menüs navigieren und Einstellungen vornehmen, ist hier anhand des Beispiels **Telefonbucheinträge erstellen** (Mobilteil) erklärt. Verfahren Sie bei allen Einstellungen wie in diesem Beispiel.

	Hauptmenü öffnen
<input type="text" value="Telefonbuch"/>	Telefonbuch öffnen
<input type="text" value="Hinzufügen"/>	Untermenü auswählen und bestätigen
<input type="text" value="Name eing."/>	Namen eingeben (max. 12 Stellen) und bestätigen
<input type="text" value="Nummer"/>	Rufnummer 1 (Handy-Nummer) eingeben (max. 24 Ziffern) und bestätigen
<input type="text" value="Nummer"/>	Rufnummer 2 (Festnetz-Nummer) eingeben (max. 24 Ziffern) und bestätigen
<input type="text" value="VIP-Melodie"/>	Klingelton zuweisen
	Zurück in den Bereitschaftsmodus



Pro Namen bzw. Eintrag können 2 Telefonnummern gespeichert werden. Dem ersten Speicherplatz ist ein Handy-Symbol vorangestellt, dem zweiten Speicherplatz ein Haus-Symbol. Wir empfehlen deshalb, bei dem ersten Speicherplatz nur Handy-Nummern zu programmieren und beim zweiten Speicherplatz nur Festnetz-Nummern.







## 5 Menüstruktur

In das Hauptmenü gelangen Sie, wenn Sie die Taste  drücken. Danach wählen Sie mit den Tasten  /  einen Eintrag aus und bestätigen Sie Ihre Auswahl mit der Taste . Weitere Informationen zum Menü und zur Bedienung  Kapitel 4.

### Intercom

Mobilteil 01 - 06 (nur wenn die entsprechende Anzahl von Mobilteilen angemeldet ist)

### Telefonbuch

Hinzufügen	
	Name eing.  <sup>1</sup>
	Nummer 
	Nummer 
	VIP-Melodie 01 / 02 / ... / Aus
Bearbeiten	
	Name eing.  <sup>1</sup>
	Nummer 
	Nummer 
	VIP-Melodie 01 / 02 / ... / Aus
Löschen	
Alle löschen	
Kopieren auf	
	Direktwahl 1
	Direktwahl 2
SPEICHER	

<sup>1</sup> Die Zifferntasten sind mit Buchstaben beschriftet. Durch mehrmaliges Drücken der entsprechenden Taste können Buchstaben, Ziffern und Sonderzeichen eingegeben werden.

# Menüstruktur

Zeit/Wecker

Wecker st.

Einmal

Aus

Ein Zeit eing. 

Täglich

Aus

Ein Zeit eing. 

Datumsformat

TT.MM

MM-TT

Zeitformat



24 Stunden

12 Stunden

Zeit einst.



## MT-Einstell.

Rufton (MT)	
Ruftonlautst	05 / ... / 01 / Aus
Rufton (ext)	12 / ... / 01
Rufton (int)	12 / ... / 01
Tastenton	Aus / Ton ein / Rufton
Akku schwach	Ein / Aus
Reichw.alarm	Ein / Aus
Equalizer	
	Natürlich
	Tiefen
	Höhen
LCD-Kontrast	06 / ... / 01
MT-Name 	
Auto.Annahme	Ein / Aus
Babyruf	
	Aus
	Ein
	Nr. eing. 
Tastensperre	Ein / Aus
Sprache	(9 Sprachen)

# Menüstruktur

## Basis-Einst.

VMWI löschen

Anmelden

Basis 1                      PIN?<sup>2</sup>

Basis 2                      PIN?<sup>2</sup>

Basis 3                      PIN?<sup>2</sup>

Basis 4                      PIN?<sup>2</sup>

Basis wählen

Basis 1

Basis 2

Basis 3

Basis 4

Automatisch

Erw. Einst.

Wahlverf.                      MFV / IWV

Flashzeit                      Kurz / Mittel / Lang

Vorwahlnr.                      

Anrufsperre                      04 / ... / 01   
Nr. eing. 

Notruf-Nr.                      04 / ... / 01   
Nr. eing. 

Abmelden                      Mobilteil

PIN ändern                      PIN? 

Zurücksetzen                      Bestätigen?

<sup>2</sup> Der PIN-Code ist werkseitig auf "0000" eingestellt.



## 6 Bedienung

### Telefon ein- und ausschalten

Wenn das Telefon ausgeschaltet ist, gehen keine Anrufe ein.

Bei ausgeschaltetem Telefon wird keine Akkuleistung verbraucht.



Bei ausgeschaltetem Telefon können keine Notrufe durchgeführt werden. Zuvor muss das Telefon eingeschaltet werden, was einige Zeit dauern kann.



Telefon einschalten (in den Bereitschaftsmodus)



Telefon ausschalten

### Tastensperre

Die Tastensperre soll verhindern, dass versehentlich Funktionen ausgelöst werden.



Tastensperre einschalten



Bei eingeschalteter Tastensperre können eingehende Anrufe wie gewohnt angenommen werden.



Tastensperre ausschalten

Ist die Tastensperre eingeschaltet, wird im Display das Symbol angezeigt.

Das Telefon kann so eingestellt werden, dass sich die Tastensperre automatisch nach 90 Sekunden einschaltet Seite 26.

### Telefonieren

#### Anruf annehmen

Neben dem Rufsignal leuchtet bei jedem Anruf auch die optische Rufanzeige.



Anruf annehmen



Halten Sie das klingelnde Telefon nicht zu dicht an Ihre Ohren, es besteht die Gefahr eines Hörschadens!

Wenn Sie die automatische Rufannahme aktiviert haben, nehmen Sie einen Anruf an, indem Sie das Mobilteil aus der Basisstation herausnehmen Seite 25.

#### Gespräch beenden



Gespräch beenden

Zum Beenden eines Gesprächs können Sie das Mobilteil auch in die Basisstation stellen.

#### Anrufen



Rufnummer eingeben (max. 24 Ziffern)



Bei Falscheingabe letzte Ziffer löschen



Rufnummer wählen





Sie können auch zuerst die Taste drücken und erhalten damit das Freizeichen. Die eingegebenen Ziffern Ihrer gewünschten Rufnummer (max. 48 Ziffern) werden sofort gewählt. Eine Korrektur einzelner Ziffern der Rufnummer ist bei dieser Form des Gesprächsaufbaus nicht möglich.

# Bedienung

## Wahlwiederholung



Ihr Mobilteil speichert die 5 zuletzt gewählten Rufnummern mit Anrufrdatum und -uhrzeit. Möchten Sie diese Rufnummern noch einmal wählen, z. B. weil der Anschluss zuvor besetzt war oder Sie niemanden erreichen konnten, nutzen Sie die Wahlwiederholung:

- |   |   |
|---|---|
|  | Wahlwiederholungsliste öffnen und Eintrag auswählen |
|  | Verbindung herstellen                               |

Die gespeicherte Rufnummer wird automatisch gewählt und die Verbindung wird hergestellt.



## Eingegangene Anrufe zurückrufen

Ihr Mobilteil speichert 40 Rufnummern in einer Anrufliste.

- |   |   |
|---|---|
|  | Anrufliste öffnen und Eintrag auswählen |
|  | Verbindung herstellen                   |

## Rufnummern aus dem Telefonbuch wählen

Sie müssen Rufnummern im Telefonbuch gespeichert haben  Seite 21.



- |   |  |
|---|--|
|  | Telefonbuch öffnen und Eintrag auswählen |
|  | Verbindung herstellen                    |



Um auf einen Telefonbucheintrag schneller zugreifen zu können, drücken Sie im geöffneten Telefonbuch die Taste mit dem Anfangsbuchstaben des Eintrags. Der erste Eintrag mit diesem Anfangsbuchstaben wird nun im Display angezeigt und ist markiert.

## Rufnummern über Direktwahltaste wählen

Sie müssen Rufnummern auf den Direktwahltasten gespeichert haben  Seite 23.









- |  |                       |
|--|-----------------------|
|  oder  | Verbindung herstellen |
|--|-----------------------|

Die gespeicherte Rufnummer wird automatisch gewählt.

## Intern telefonieren

Sie müssen zwei oder mehr Mobilteile (MT1, MT2, ...) an Ihrem Telefon (Ihrer Basisstation) angemeldet haben, um intern kostenlos zu telefonieren.

## Interne Gespräche führen

- |   |   |
|---|---|
|  ,  , <b>Intercom</b> ,  | Internes Telefonieren einleiten                     |
|  /  ,                 | Interne Rufnummer des gewünschten Mobilteils wählen |
| MT2:   | Internes Gespräch am anderen Mobilteil annehmen     |
| MT1 / MT2:   | Internes Gespräch beenden                           |



Wenn das Mobilteil, das Sie intern anrufen wollen, ein externes Telefongespräch führt, hören Sie einen Signalton und im Display sehen Sie Ltg. belegt.

## Externe Gespräche während eines internen Telefonats annehmen











Wenn ein externer Anruf eingeht, während Sie ein internes Telefongespräch führen, wird eine Meldung im Display angezeigt.







- |   |                            |
|---|----------------------------|
|  | Externes Gespräch annehmen |
|---|----------------------------|

Am Mobilteil, das das externe Gespräch nicht angenommen hat, die Taste  drücken, um das interne Gespräch zu beenden.













## Externe Gespräche intern weiterleiten

 /  /  , <b>Intercom</b> , 	Während des externen Gesprächs
 /  , 	Interne Rufnummer des gewünschten Mobilteils wählen
MT2: 	Internes Gespräch am anderen Mobilteil annehmen
MT1: 	Gespräch weiterleiten

oder











3 Sek.  <b>Intercom</b>	Während des externen Gesprächs
 /  , 	Interne Rufnummer des gewünschten Mobilteils wählen
MT2: 	Internes Gespräch am anderen Mobilteil annehmen
MT1: 	Gespräch weiterleiten

## Rücksprache / Makeln







 /  /  , <b>Intercom</b> , 	Während des externen Gesprächs
 /  , 	Interne Rufnummer des gewünschten Mobilteils wählen
MT2: 	Internes Gespräch am anderen Mobilteil annehmen
 /  /  , <b>Makeln</b> , 	Gesprächspartner wechseln

## Konferenzgespräche führen

Ein externes Gespräch kann mit einem weiteren internen Gesprächspartner zum Konferenzgespräch geschaltet werden.

 /  /  , <b>Intercom</b> , 	Während des externen Gesprächs
 /  , 	Interne Rufnummer des gewünschten Mobilteils wählen
MT2: 	Internes Gespräch am anderen Mobilteil annehmen
MT1: 2 Sek.  , <b>Konferenz</b>	Konferenzgespräch starten
MT1 / MT2: 	Konferenz beenden

oder

3 Sek.  <b>Intercom</b>	Während des externen Gesprächs
 /  , 	Interne Rufnummer des gewünschten Mobilteils wählen
MT1: 2 Sek.  , <b>Konferenz</b>	Konferenzgespräch starten
MT1 / MT2: 	Konferenz beenden

# Bedienung

## Anzeige der Gesprächsdauer

Einige Sekunden nach Beginn eines Gesprächs zeigt Ihnen das Display die aktuelle Gesprächsdauer in Minuten und Sekunden an.

## Hörerlautstärke einstellen

Sie können während eines Gesprächs die Hörerlautstärke in 5 Stufen anpassen.



Hörerlautstärke erhöhen / verringern

## Ruftonlautstärke

### Ruftonlautstärke einstellen

Sie können die Lautstärke des Ruftons verändern. Es stehen 5 Lautstärken zur Verfügung sowie die Möglichkeit, den Rufton auszuschalten.



Menü öffnen



MT-Einstell.



MT-Einstell. auswählen



Rufton (MT)



Rufton (MT) auswählen



Ruftonlautst



Ruftonlautst auswählen



Ruftonlautstärke erhöhen / verringern



Einstellung speichern

### Rufton aus- und einschalten

3 Sek.

Rufton ausschalten

3 Sek.

Rufton einschalten

Sie können den Rufton auch über das Menü ausschalten.

Ist der Rufton ausgeschaltet, wird im Display das Symbol angezeigt.

## Freisprechen

Nutzen Sie diese Funktion, um den Gesprächspartner über den Lautsprecher zu hören.



Während eines Gesprächs: Freisprechen einschalten



Während eines Gesprächs: Freisprechen ausschalten

Ist das Freisprechen aktiviert, wird im Display das Symbol angezeigt.

## Mikrofon stummschalten

Sie können während eines Telefongesprächs das Mikrofon des Mobilteils aus- und einschalten, so dass Ihr Gesprächspartner am Telefon Sie nicht hört, z. B. wenn Sie mit einer anderen Person im Raum Rücksprache halten wollen.

2 Sek.

Während eines Gesprächs: Mikrofon ausschalten (stummschalten)

2 Sek.

Während eines Gesprächs: Mikrofon einschalten

Ist das Mikrofon stumm geschaltet, wird im Display das Symbol angezeigt.

## Telefonbuch





Im Telefonbuch können Sie 50 Gesprächspartner mit bis zu jeweils 2 Telefonnummern speichern.

- Geben Sie bei allen Rufnummern immer die Vorwahl mit ein, damit auch eingehende Ortsgespräche einem Telefonbucheintrag zugeordnet werden können.
- Ist die Speicherkapazität erschöpft, zeigt das Display beim nächsten Speichern die Meldung **Sp. voll!**. Um wieder Platz zu schaffen, müssen Sie zuerst einen anderen Eintrag löschen.
- Die Telefonbucheinträge sind alphabetisch geordnet.

Befinden Sie sich im Telefonbuch, wird im Display das Symbol  angezeigt.

## Namen eingeben

Die Zifferntasten sind mit Buchstaben beschriftet. Durch mehrmaliges Drücken der entsprechenden Taste können Buchstaben, Ziffern und Sonderzeichen eingegeben werden.



	Leerzeichen eingeben
	Sonderzeichen eingeben
	Löschen
	Cursor bewegen



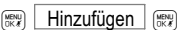
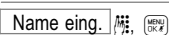
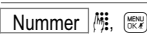

Um den gleichen Buchstaben zweimal einzugeben, drücken Sie die entsprechende Taste. Warten Sie, bis der Cursor eine Stelle weitergesprungen ist. Geben Sie den Buchstaben erneut ein.

## Telefonbucheinträge erstellen

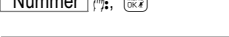
 auch Seite 12

	Telefonbuch öffnen
	Untermenü auswählen und bestätigen
	Namen eingeben (max. 12 Stellen) und bestätigen
	Rufnummer 1 (Handy-Nummer) eingeben (max. 24 Ziffern) und bestätigen
	Rufnummer 2 (Festnetz-Nummer) eingeben (max. 24 Ziffern) und bestätigen
	Klingelton zuweisen

Sind die Einträge länger, als sie im Display dargestellt werden können, werden im Display die Symbole  und  angezeigt. Sie zeigen an, dass der Eintrag nach links oder rechts über das Display hinausgeht.

Ist die Speicherkapazität erschöpft, zeigt das Display beim nächsten Speichern die Meldung **Sp. voll!**. Um wieder Platz zu schaffen, müssen Sie zuerst einen anderen Eintrag löschen.

Ist ein Name bereits vorhanden, unter dem Sie einen neuen Eintrag abspeichern wollen, zeigt das Display beim Speichern die Meldung **Name doppelt**.

# Bedienung

## Telefonbucheinträge ändern

	Telefonbuch öffnen
/  ,	Eintrag auswählen und bestätigen
/  , <b>Bearbeiten</b>	Untermenü auswählen und bestätigen
<b>Name eing.</b> ,	Namen ändern (max. 12 Stellen) und bestätigen
<b>Nummer</b> ,	Rufnummer 1 (Handy-Nummer) ändern (max. 24 Ziffern) und bestätigen
<b>Nummer</b> ,	Rufnummer 2 (Festnetz-Nummer) ändern (max. 24 Ziffern) und bestätigen
<b>VIP-Melodie</b> /  ,	Klingelton zuweisen

## Telefonbucheinträge löschen

### Einen Eintrag löschen

	Telefonbuch öffnen
/  ,	Eintrag auswählen und bestätigen
/  , <b>Löschen</b>	Untermenü auswählen und bestätigen



Um auf einen Telefonbucheintrag schneller zugreifen zu können, drücken Sie im geöffneten Telefonbuch die Taste mit dem Anfangsbuchstaben des Eintrags. Der erste Eintrag mit diesem Anfangsbuchstaben wird nun im Display angezeigt und ist markiert.

### Alle Einträge löschen

	Telefonbuch öffnen
	Menü öffnen
/  , <b>Alle löschen</b>	Untermenü auswählen und bestätigen
<b>Bestätigen?</b> <b>Kein Eintr.</b>	Löschvorgang bestätigen

oder

<b>Bestätigen?</b> oder	Löschvorgang abbrechen
-------------------------	------------------------

## Telefonbuchkapazität prüfen

Lassen Sie sich anzeigen, wie viele der 50 Speicherplätze belegt sind.

	Telefonbuch öffnen
	Menü öffnen
/  , <b>SPEICHER</b>	Untermenü auswählen und bestätigen

## Direktwahltasten programmieren

Sie haben die Möglichkeit, 2 Telefonnummern aus dem Telefonbuch so abzuspeichern, dass diese jeweils nur durch den Druck von Taste **(M1)** oder **(M2)** gewählt werden (Direktwahl).

	Telefonbuch öffnen
/  ,	Eintrag auswählen und bestätigen
/  , <b>Kopieren auf</b>	Untermenü auswählen und bestätigen
<b>Direktwahl 1</b> ,  /  ,	Direktwahltaste auswählen und bestätigen
	Angezeigte Telefonnummer bestätigen

Rufnummer über Direktwahltaste wählen Seite 18.

## Wahlwiederholungsliste

Ihr Mobilteil speichert die 5 zuletzt gewählten Rufnummern mit Anruftdatum und -uhrzeit.

### Rufnummer aus der Wahlwiederholungsliste im Telefonbuch abspeichern

	Wahlwiederholungsliste öffnen
/  ,	Eintrag auswählen und bestätigen
/  , <b>Nr. speichern</b>	Untermenü auswählen und bestätigen
<b>Name eing.</b> ,	Namen eingeben (max. 12 Stellen) und bestätigen
<b>Nr. eing.</b> ,	Rufnummer gegebenenfalls ändern (max. 24 Ziffern) und bestätigen
/  ,	Festlegen, ob die Rufnummer eine Handy-Nummer oder eine Festnetz-Nummer ist und bestätigen

### Rufnummer aus der Wahlwiederholungsliste löschen

	Wahlwiederholungsliste öffnen
/  ,	Eintrag auswählen und bestätigen
/  , <b>Löschen</b>	Untermenü auswählen und bestätigen

### Gesamte Wahlwiederholungsliste löschen

	Wahlwiederholungsliste öffnen
	Menü öffnen
/  , <b>Alle löschen</b>	Untermenü auswählen und bestätigen
<b>Bestätigen?</b> , <b>Kein Entr.</b>	Löschvorgang bestätigen

oder

<b>Bestätigen?</b> , <b>(R)</b> oder	Löschvorgang abbrechen
--------------------------------------	------------------------

### Rufnummer aus der Wahlwiederholungsliste wählen

Seite 18

# Bedienung

## Anrufliste

Während Ihrer Abwesenheit werden alle eingehenden Anrufe in einer Anrufliste gesammelt. Insgesamt können dort bis zu 40 Rufnummern gespeichert werden. Für jeden Anruf werden Datum und Uhrzeit des Eingangs festgehalten.

Befinden Sie sich in der Anrufliste, wird im Display das Symbol  angezeigt.

In der Anrufliste wird der zuletzt eingegangene Anruf zuerst aufgelistet.

Wurden während Ihrer Abwesenheit Anrufe registriert, blinkt die optische Rufanzeige und im Display das Symbol . Im Display wird außerdem bis zum ersten Öffnen der Anrufliste ein Hinweis angezeigt, wie viele Anrufe Ihnen entgangen sind.

## Rufnummern aus der Anrufliste anzeigen

 Anrufliste öffnen und Eintrag auswählen

## Rufnummer aus der Anrufliste im Telefonbuch speichern

Eine Rufnummer kann direkt aus der Anrufliste im Telefonbuch gespeichert werden.

 Anrufliste öffnen und Eintrag auswählen

 Menü öffnen

 Untermenü auswählen und bestätigen

 Namen eingeben (max. 12 Stellen) und bestätigen

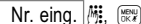
 Rufnummer gegebenenfalls ändern (max. 24 Ziffern) und bestätigen

 Festlegen, ob die Rufnummer eine Handy-Nummer oder eine Festnetz-Nummer ist und bestätigen

## Rufnummern aus der Anrufliste löschen

### Einzelne Rufnummer löschen

 Anrufliste öffnen und Eintrag auswählen

 Menü öffnen



 Untermenü auswählen und bestätigen

### Alle Rufnummern löschen

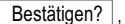

 Anrufliste öffnen

 Menü öffnen

 Untermenü auswählen und bestätigen

  Löschvorgang bestätigen

oder

  oder  Löschvorgang abbrechen

## Eingegangene Anrufe zurückrufen



## Ton- und Anzeigeeinstellungen

Sie können verschiedene Einstellungen vornehmen, um das Telefon Ihren Bedürfnissen entsprechend einzurichten:

### Rufton einstellen

Legen Sie für externe und für interne Anrufe den grundsätzlich zu verwendenden Rufton fest. Es stehen insgesamt 12 polyphone Ruftöne zur Verfügung.

Rufton einstellen ☞ Menü Seite 15

### Tastentöne

Tastentöne geben Ihnen eine Bestätigung, dass Sie eine Taste wirklich gedrückt haben. Das Telefon kann so eingestellt werden, dass beim Drücken einer beliebigen Taste immer der gleiche Tastenton ertönt (Einstellung Ton ein), oder dass unterschiedliche Tastentöne erzeugt werden (Einstellung Rufton). Außerdem können die Tastentöne ausgeschaltet werden.

Tastentöne einstellen ☞ Menü Seite 15

### Warnton Akkukapazität

Ein Warnton macht darauf aufmerksam, dass die Kapazität der Akkus schwach ist.

Warnton Akkukapazität (Akku schwach) einstellen ☞ Menü Seite 15

### Warnton Reichweite

Ein Warnton macht darauf aufmerksam, dass Sie sich mit dem Mobilteil aus der Reichweite der Basisstation entfernen.

Warnton Reichweite (Reichw.alarm) einstellen ☞ Menü Seite 15

### Equalizer

Passen Sie den Klang des Lautsprechers Ihren Wünschen an. Belassen Sie den Klang Natürlich oder heben Sie Tiefen oder Höhen hervor.

Equalizer einstellen ☞ Menü Seite 15

### Display-Kontrast

Der Kontrast des Displays (LCD-Kontrast) kann in 6 Stufen verändert werden ☞ Menü Seite 15

### Mobilteilname

Sie können dem Mobilteil einen individuellen Namen geben (MT-Name) ☞ Menü Seite 15

### Zeit- und Datumsformat

Legen Sie fest, in welchem Format und in welcher Reihenfolge Zeit und Datum angezeigt werden sollen ☞ Menü Seite 14

## Sonstige Einstellungen

### Automatische Rufannahme

Haben Sie diese Funktion aktiviert, wird ein Anruf automatisch beim Herausnehmen des Mobilteils aus der Basisstation angenommen. Die automatische Anrufannahme wird über das Menü aktiviert oder deaktiviert.

Automatische Rufannahme aktivieren ☞ Menü Seite 15

# Bedienung



---

## Tastensperre

Ist diese Einstellung aktiviert, schaltet sich automatisch die Tastensperre ein, wenn 90 Sekunden keine Taste gedrückt wurde. Ist die Tastensperre eingeschaltet, wird im Display das Symbol  angezeigt.

Tastensperre aktivieren  Menü Seite 15

## Vorwahlnummer

Sie können eine Vorwahlnummer hinterlegen (Vorwahlnr.). Durch langes Betätigen der Taste  bevor oder nachdem Sie die Rufnummer eingegeben haben, wird die Vorwahlnummer der Rufnummer vorangestellt. Durch Betätigen der Taste  wird diese Rufnummer gewählt.

Vorwahlnummer ändern  Menü Seite 16

## PIN ändern

Der PIN-Code wird zum Anmelden von Mobilteilen benötigt. Er ist werkseitig auf "0000" eingestellt.  
PIN ändern  Menü Seite 16

## Zurücksetzen

Mit dieser Funktion haben Sie die Möglichkeit, Ihr Telefon auf Werkseinstellungen zurückzusetzen.

Zurücksetzen  Menü Seite 16

## Mobilteil suchen (Paging)

Wenn Sie Ihr Mobilteil verlegt haben, können Sie es über einen Suchton leicht wiederfinden.



Bedingungen: Das Mobilteil ist angeschaltet und befindet sich in Reichweite der Basisstation. Die Akkus sind nicht leer.



Suchton starten



---

Suchton beenden

## Besondere Funktionen

### Wecker

Mit dieser Funktion können Sie sich zu einer bestimmten Zeit von Ihrem Mobilteil wecken bzw. erinnern lassen. Ist der Wecker eingeschaltet, wird im Display das Symbol  angezeigt. Zur eingestellten Weckzeit wird der gewählte Rufton für 1 Minute abgespielt. Im Display wird der Hinweis Wecker angezeigt.

### Wecker stellen

Sie können wählen, ob Sie den Wecker nur für eine Weckaktion stellen wollen (Einmal) oder ob Sie Ihr Telefon täglich zur gleichen Zeit wecken soll (Täglich).



Wecker einstellen (Wecker st.)  Menü Seite 14

### Weckruf vorzeitig beenden



Weckruf beenden

### Babyruf

Mit dieser Funktion haben Sie die Möglichkeit, eine bestimmte Rufnummer (max. 24 Ziffern) zu speichern, die bei Betätigen einer beliebigen Taste (außer den Tasten  und ) automatisch angerufen wird.

Ist die Funktion eingeschaltet, blinkt im Display dauerhaft die Anzeige Babyruf .

Babyruf aktivieren  Menü Seite 15

### Anrufsperre

Die Anrufsperre hindert Mobilteile daran, Rufnummern zu wählen, die mit den von Ihnen hinterlegte Ziffern beginnen. Sie können 4 Sperrnummern mit jeweils max. 8 Ziffern hinterlegen.

Anrufsperre aktivieren  Menü Seite 16

### Notruf-Nummer

Sie können bis zu 4 Rufnummern hinterlegen, die trotz aktivierter Anrufsperre gewählt werden können. Auf Seite 16 finden Sie die Position im Menü.

### Wahlverfahren

Sie können Ihr Mobilteil sowohl an den analogen Vermittlungsstellen (Impulswahl-Verfahren / IWV) als auch an den neuen digitalen Vermittlungsstellen (Tonwahl-Verfahren / MFV) betreiben. Das Wahlverfahren wird über das Menü eingestellt. Auf Seite 16 finden Sie die Position im Menü.

### Rufnummernanzeige (CLIP)



Die Rufnummernanzeige (CLIP) sowie die Anzeige von Datum und Uhrzeit sind optionale Dienste Ihres Netzbetreibers. Bitte fragen Sie diesen nach weiteren Informationen.

Steht Ihrer Telefonanlage die CLIP-Funktion zur Verfügung (CLIP = Calling Line Identification Presentation), zeigt das Display bei einem eingehenden Anruf die Rufnummer des Anrufers an, soweit dieser der Rufnummerübertragung zugestimmt hat.



Nehmen Sie einen Anruf nicht an, bleibt die Anzeige für ca. 6 Sekunden im Display, bevor anschließend wieder die aktuelle Uhrzeit und das Datum angezeigt werden.

# Erweitern des Telefonsystems

## 7 Erweitern des Telefonsystems

Über den international genormten **GAP**<sup>1</sup>-Standard ist die Kompatibilität von Mobilteilen und Telefonen (Basisstationen) unterschiedlicher Hersteller geregelt. So ist es möglich, SWITEL-Geräte und Geräte anderer Hersteller zusammen in ein Telefonsystem zu integrieren. Es ist jedoch möglich, dass einige Funktionen nicht zur Verfügung stehen.

### Mehrere Mobilteile





Sie können insgesamt 6 Mobilteile an Ihr Telefon (Ihre Basisstation) anmelden.

### Anmelden von Mobilteilen

Mobilteile werden über das Menü des Telefons (der Basisstation) angemeldet. Auf Seite 16 finden Sie die Position im Menü.

ca. 10 Sek. 

Für den Anmeldevorgang die Taste solange drücken bis die optische Rufanzeige des Telefons blinkt.

 /  /  , **Basis-Einst.** ,  Menü öffnen

 /  , **Anmelden** ,  Menü öffnen

 /  , **Basis x** ,  Basis auswählen

**PIN?**  ,  PIN<sup>2</sup> eingeben und bestätigen

Das Mobilteil sucht die Basisstation. Dieser Vorgang kann bis zu 2 Minuten dauern.

Nach dem Anmelden wird dem Mobilteil eine interne Rufnummer zugeteilt. Diese interne Rufnummer wird im Display angezeigt.



Um Mobilteile anderer Hersteller anzumelden, lesen Sie bitte deren Bedienungsanleitungen.

### Abmelden von Mobilteilen



Sie können ein Mobilteil von einem Telefon (einer Basisstation) nur durch ein weiteres an diesem Telefon (dieser Basisstation) angemeldetes Mobilteil abmelden.

Mobilteile werden über das Menü des Telefons (der Basisstation) abgemeldet. Auf Seite 16 finden Sie die Position im Menü.

### Mehrere Basisstationen

Sie können die Reichweite Ihres Mobilteils vergrößern, wenn Sie es an mehrere Telefone (Basisstationen) anmelden. Es kann gleichzeitig an 4 verschiedenen Telefonen (Basisstationen) angemeldet sein. Jedes Telefon (jede Basisstation) benötigt eine eigene Telefonanschlussdose. Es können Anschlüsse mit derselben und auch mit unterschiedlichen Rufnummern sein.



Laufende Gespräche können nicht von einem zum anderen Telefon (einer zur anderen Basisstation) übertragen werden.

<sup>1</sup> **GAP**: **Generic Access Profile** = Standard für das Zusammenwirken von Mobilteilen und Basisstationen unterschiedlicher Hersteller.

<sup>2</sup> Der PIN-Code ist werkseitig auf "0000" eingestellt.

## 8 Nebenstellenanlagen / Zusatzdienste

### R-Taste und Zusatzdienste

Ihr Telefon unterstützt Zusatzdienste Ihres Netzbetreibers, wie z. B. Makeln, Anklopfen und Konferenz. Über die Taste  können Sie diese Zusatzdienste nutzen. Bitte fragen Sie Ihren Netzbetreiber, welche Flash-Zeit Sie zur Nutzung von Zusatzdiensten einstellen müssen. Zur Freischaltung von Zusatzdiensten wenden Sie sich bitte an Ihren Netzbetreiber. Die Flash-Zeit stellen Sie über das Menü ein. Auf Seite 16 finden Sie die Position im Menü.

### R-Taste an Nebenstellenanlagen

Ist Ihr Telefon an einer Nebenstellenanlage angeschlossen, können Sie über die Taste  Funktionen, wie z. B. Anrufe weiterleiten und automatischen Rückruf, nutzen. Lesen Sie bitte in der Bedienungsanleitung Ihrer Nebenstellenanlage, welche Flash-Zeit Sie zur Nutzung dieser Funktionen einstellen müssen. Ob Ihr Telefon an Ihrer Nebenstellenanlage einwandfrei funktioniert, erfahren Sie bei dem Händler, bei dem die Anlage gekauft wurde. Die Flash-Zeit stellen Sie über das Menü ein. Auf Seite 16 finden Sie die Position im Menü.

### Zugangscode (Amtskennzahl)

Bei Nebenstellenanlagen ist es erforderlich, eine Amtskennzahl vorzuwählen, um ein Freizeichen zu bekommen. Oftmals ist die Amtskennzahl eine "0" oder eine "9". Tippen Sie zuerst diese Amtskennziffer ein und warten Sie das Freizeichen ab. Jetzt können Sie die eigentliche Rufnummer eingeben.



Wenn Sie die Direktwahlfunktionen Ihres Telefons auch an einer Nebenstellenanlage nutzen möchten, beachten Sie bitte, dass Sie beim Programmieren der Direktwahltasten die Amtskennziffer der eigentlichen Rufnummer voranstellen. Zwischen Amtskennziffer und Rufnummer können Sie gegebenenfalls auch noch eine Wahlpause einprogrammieren  Abschnitt "Wahlpause".

### Wahlpause

Bei Nebenstellenanlagen ist es erforderlich, eine Amtskennzahl vorzuwählen, um ein Freizeichen zu bekommen. Bei wenigen älteren Nebenstellenanlagen dauert es einige Zeit, bis das Freizeichen zu hören ist. Für diese Nebenstellenanlagen kann nach der Amtskennzahl eine Wahlpause eingefügt werden, um direkt weiterwählen zu können, ohne das Freizeichen abzuwarten. Die Wahlpause fügen Sie durch Drücken und 3 Sek. Halten der Taste  ein.

Nach der Amtskennzahl erfolgt die Wahl der eigentlichen Rufnummer nach einer bestimmten Zeit.



Die Wahlpause kann auch bei der Eingabe von Rufnummern im Telefonbuch gespeichert werden.

# Nebenstellenanlagen / Zusatzdienste

## Rufnummernanzeige (CLIP<sup>1</sup>)



Die Rufnummernanzeige ist ein Zusatzdienst Ihres Netzbetreibers. Fragen Sie Ihren Netzbetreiber nach weiteren Informationen.

Wenn diese Funktion an Ihrer Telefonleitung zur Verfügung steht, wird Ihnen bereits die Rufnummer des Anrufers angezeigt, wenn das Telefon klingelt. Hat der Anrufer das Übertragen seiner Rufnummer unterdrückt, wird eine entsprechende Meldung angezeigt. Die Rufnummer kann nicht angezeigt und somit auch nicht in der Anrufliste gespeichert werden.

## Anrufbeantworter im Telefonnetz

Der Anrufbeantworter im Telefonnetz ist ein Zusatzdienst vieler Netzbetreiber. Wenn Ihr Netzbetreiber einen Anrufbeantworter im Telefonnetz für Sie bereitstellt, werden Sie mit einem Symbol über neue Nachrichten informiert (**VMWI**<sup>2</sup>). Über diese Funktion können Sie nur dann verfügen, wenn Ihr Netzbetreiber diesen Zusatzdienst anbietet. Bitte fragen Sie Ihren Netzbetreiber nach weiteren Informationen.

<sup>1</sup> **CLIP**: Calling Line Identification Presentation = Anzeige der Rufnummer eines Anrufers.

<sup>2</sup> **VMWI**: Visual Message Waiting Indication = Optische Anzeige neuer Nachrichten.

# Technische Eigenschaften

## 9 Technische Eigenschaften

Merkmal	Wert
Standard	DECT <sup>1</sup> -GAP <sup>2</sup>
Stromversorgung (Basisstation)	Eingang: 100-240 V, 50-60 Hz Ausgang: 6 V, 500 mA
Reichweite	Außen: ca. 300 m Innen: ca. 50 m
Stand-by-Zeit	Bis zu 110 h
Max. Gesprächsdauer	Bis zu 11 h
Max. Hörerlautstärke	30 dB
Aufladbare Akkus	2 x 1.2 V 500 mAh NiMH, Größe: AAA
Wahlverfahren	Tonwahl-Verfahren (MFV) Impulswahl-Verfahren (IWW)
Flash-Zeit	Kurz, Mittel, Lang
Anzahl Ruftöne	12 (polyphone)
Max. Anzahl Einträge Telefonbuch	50
Max. Anzahl Einträge Anrufliste	40
Max. Anzahl Einträge Wahlwiederholung	5
Menüsprachen	Deutsch, Französisch, Italienisch, Englisch, Spanisch, Portugiesisch, Niederländisch, Polnisch, Türkisch

### Konformitätserklärung

Dieses Gerät erfüllt die Anforderungen der EU-Richtlinie:

1999/5/EG Richtlinie über Funkanlagen und Telekommunikationsendeinrichtungen und die gegenseitige Anerkennung ihrer Konformität. Die Konformität mit der o. a. Richtlinie wird durch das CE-Zeichen auf dem Gerät bestätigt.



### Service-Hotline

Haben Sie Probleme mit Ihrem Telefon, kontrollieren Sie zuerst die folgenden Hinweise. Bei technischen Problemen können Sie sich an unsere Service-Hotline unter Tel. 0900 00 1675 innerhalb der Schweiz (Kosten Swisscom bei Drucklegung: CHF 2.60/min) wenden. Bei Garantieansprüchen wenden Sie sich an Ihren Fachhändler. Die Garantiezeit beträgt 2 Jahre.

<sup>1</sup> DECT: Digital Enhanced Cordless Telecommunication = Standard für kabellose Telefone.

<sup>2</sup> GAP: Generic Access Profile = Standard für das Zusammenwirken von Mobilteilen und Basisstationen unterschiedlicher Hersteller.

# Probleme

## 10 Probleme

Fragen	Antworten
Kein Telefongespräch möglich	<ul style="list-style-type: none"><li>- Das Telefon bzw. die Basisstation ist nicht korrekt angeschlossen oder gestört. Verwenden Sie nur das mitgelieferte Telefonanschlusskabel.</li><li>- Das Netzteil ist nicht eingesteckt oder es liegt ein totaler Stromausfall vor.</li><li>- Testen Sie mit einem anderen Telefon, ob Ihr Telefonanschluss in Ordnung ist.</li><li>- Falscher Aufstellungsort des Telefons (der Basisstation).</li><li>- Die aufladbaren Akkus sind leer oder defekt.</li><li>- Sie haben sich zu weit von der Basisstation entfernt.</li><li>- Wahlverfahren falsch eingestellt ☞ Seite 16.</li><li>- Wenn mehrere Mobilteile angemeldet sind: An einem anderen Mobilteil wird ein Gespräch geführt.</li><li>- Bei internen Telefongesprächen: Das angerufene Mobilteil ist außerhalb der Reichweite der Basisstation.</li><li>- Die Tastensperre ist aktiviert.</li><li>- Das Mobilteil ist nicht eingeschaltet.</li></ul>
Keine Verbindung zum Telefon (Basisstation) möglich	<ul style="list-style-type: none"><li>- Prüfen Sie, ob Sie sich mit dem richtigen PIN-Code an dem Telefon (Basisstation) angemeldet haben ☞ Seite 16.</li></ul>
Verbindung abgehackt, fällt aus	<ul style="list-style-type: none"><li>- Sie haben sich zu weit von der Basisstation entfernt.</li><li>- Falscher Aufstellungsort des Telefons (der Basisstation).</li></ul>
Während eines Telefongesprächs ertönen Signaltöne	<ul style="list-style-type: none"><li>- Sie haben sich zu weit von der Basisstation entfernt.</li><li>- Die aufladbaren Akkus sind fast leer.</li></ul>
Das System reagiert nicht mehr	<ul style="list-style-type: none"><li>- Setzen Sie alle Funktionen auf Werkseinstellungen zurück ☞ Seite 16.</li><li>- Ziehen Sie kurzzeitig das Netzteil aus der Steckdose.</li></ul>
Die Akkus sind in kürzester Zeit leer	<ul style="list-style-type: none"><li>- Die Akkus sind leer oder defekt.</li><li>- Stellen Sie das Mobilteil richtig auf die Basis-/Ladestation. Reinigen Sie die Kontaktflächen am Mobilteil und an der Basis-/Ladestation mit einem weichen trockenen Tuch.</li><li>- Stellen Sie das Mobilteil für 8 Stunden in die Basis-/Ladestation.</li></ul>
Die Akkus lassen sich nicht mehr aufladen	<ul style="list-style-type: none"><li>- Die Akkus sind defekt.</li></ul>
Die Rufnummernanzeige (CLIP) funktioniert nicht	<ul style="list-style-type: none"><li>- Die Rufnummernanzeige ist ein Zusatzdienst Ihres Netzbetreibers. Bitte fragen Sie Ihren Netzbetreiber nach weiteren Informationen.</li><li>- Der Anrufer hat das Übertragen seiner Rufnummer unterdrückt.</li></ul>



## 11 Pflegehinweise / Garantie

### Pflegehinweise

- Reinigen Sie die Gehäuseoberflächen mit einem weichen und fusselfreien Tuch.
- Verwenden Sie keine Reinigungs- oder Lösungsmittel.

Außer einer gelegentlichen Gehäusereinigung ist keine weitere Pflege erforderlich.

### Garantie

SWITEL - Geräte werden nach den modernsten Produktionsverfahren hergestellt und geprüft. Ausgesuchte Materialien und hoch entwickelte Technologien sorgen für einwandfreie Funktion und lange Lebensdauer. Ein Garantiefall liegt nicht vor, wenn die Ursache einer Fehlfunktion des Geräts bei dem Telefonnetzbetreiber oder einer eventuell zwischengeschalteten Nebenstellenanlage liegt. Die Garantie gilt nicht für die in den Produkten verwendeten Batterien, Akkus oder Akkupacks. Die Garantiezeit beträgt 24 Monate, gerechnet vom Tage des Kaufs.

Innerhalb der Garantiezeit werden alle Mängel, die auf Material- oder Herstellungsfehler zurückzuführen sind, kostenlos beseitigt. Der Garantieanspruch erlischt bei Eingriffen durch den Käufer oder durch Dritte. Schäden, die durch unsachgemäße Behandlung oder Bedienung, natürliche Abnutzung, durch falsches Aufstellen oder Aufbewahren, durch unsachgemäßen Anschluss oder Installation sowie durch höhere Gewalt oder sonstige äußere Einflüsse entstehen, fallen nicht unter die Garantieleistung. Wir behalten uns vor, bei Reklamationen die defekten Teile auszubessern, zu ersetzen oder das Gerät auszutauschen. Ausgetauschte Teile oder ausgetauschte Geräte gehen in unser Eigentum über. Schadenersatzansprüche sind ausgeschlossen, soweit sie nicht auf Vorsatz oder grober Fahrlässigkeit des Herstellers beruhen.

Sollte Ihr Gerät dennoch einen Defekt innerhalb der Garantiezeit aufweisen, wenden Sie sich bitte unter Vorlage Ihrer Kaufquittung ausschließlich an das Geschäft, in dem Sie Ihr SWITEL - Gerät gekauft haben. Alle Gewährleistungsansprüche nach diesen Bestimmungen sind ausschließlich gegenüber Ihrem Fachhändler geltend zu machen. Nach Ablauf von zwei Jahren nach Kauf und Übergabe unserer Produkte können Gewährleistungsrechte nicht mehr geltend gemacht werden.

## 12 Stichwortverzeichnis

### A

Abmelden, 28  
Akkuladestatus, 7  
Akkus, 5, 31  
Akkus aufladen, 7  
Akkus einsetzen, 7  
Alle Einträge löschen, 22  
Alle Rufnummern löschen, 24  
Amtskennzahl, 29  
Anmelden, 28  
Anruf annehmen, 17  
Anrufbeantworter im Telefonnetz, 30  
Anrufe in Abwesenheit, 24  
Anrufen, 17  
Anrufliste, 24  
Anrufsperrung, 27  
Anzahl Einträge Anrufliste, 31  
Anzahl Einträge Telefonbuch, 31  
Anzahl Einträge Wahlwiederholung, 31  
Aufstellungsort, 4  
Automatische Rufannahme, 25

### B

Babyruf, 27  
Basisstation, 10  
Basisstation anschließen, 6  
Bedienelemente, 8  
Bedienung, 17  
Bereitschaftsmodus, 11  
Besondere Funktionen, 27  
Bestimmungsgemäße Verwendung, 4

### C

CLIP, 27, 30

### D

Darstellungsweise, 11  
Datum einstellen, 7  
DECT, 31  
Direktwahl, 18  
Direktwahlkosten programmieren, 23  
Display, 9  
Display-Kontrast, 25  
Display-Sprache einstellen, 7  
Display-Symbole, 9

### E

ECO-Mode, 7  
Einen Eintrag löschen, 22  
Eingegangene Anrufe zurückrufen, 18, 24  
Einzelne Rufnummer löschen, 24  
Entsorgung, 5  
Equalizer, 25  
Erstellen, 12  
Erweitern des Telefonsystems, 28  
Externe Gespräche intern weiterleiten, 19  
Externe Gespräche während eines internen Telefonats annehmen, 18

### F

Flash-Zeit, 31  
Freisprechen, 20

### G

GAP, 31  
Garantie, 33  
Gespräch beenden, 17  
Gesprächsdauer, 20, 31  
Gesprächsweiterleitung, 19

### H

Hauptmenü, 13  
Hörerlautstärke, 31  
Hörerlautstärke einstellen, 20  
Hörgeräte-kompatibel, 5

## I

Inbetriebnahme, 6  
Intern telefonieren, 18  
Interngespräche, 18

## K

Konferenzgespräche, 19  
Konformitätserklärung, 31

## M

Makeln, 19  
Medizinische Geräte, 5  
Mehrere Basisstationen, 28  
Mehrere Mobilteile, 28  
Menüführung, 11  
Menüsprachen, 31  
Menüstruktur, 13  
Mikrofon stummschalten, 20  
Mobilteil, 8  
Mobilteil abmelden, 28  
Mobilteil anmelden, 28  
Mobilteil in Betrieb nehmen, 6  
Mobilteilname, 25

## N

Namen eingeben, 21  
Nebenstellenanlagen, 7, 29  
Netzteil, 4  
Notruf, 27

## P

Paging, 26  
Pflegehinweise, 33  
PIN ändern, 26  
Probleme, 32

## R

R-Taste, 29  
Reichweite, 31  
Reinigen, 33  
Rückruf, 18  
Rücksprache, 19  
Rufnummer aus der Wahlwiederholungsliste im Telefonbuch abspeichern, 23  
Rufnummer aus der Wahlwiederholungsliste löschen, 23  
Rufnummer aus der Wahlwiederholungsliste wählen, 23  
Rufnummern aus der Anrufliste löschen, 24  
Rufnummernanzeige, 24, 30  
Rufnummernanzeige (CLIP), 27  
Rufton aus- und einschalten, 20  
Rufton einstellen, 25  
Ruftöne, 31  
Ruftonlautstärke einstellen, 20

## S

Service-Hotline, 31  
Sicherheitshinweise, 4  
Speichern, 12, 24  
Stand-by-Zeit, 31  
Strahlungsreduzierung, 7  
Stromausfall, 4  
Stromversorgung, 31  
Stummschaltung, 20  
Suchen, 26  
Symbole, 9

# Stichwortverzeichnis

---

## T

- Tastensperre, 17, 26
- Tastentöne, 25
- Telefon ausschalten, 17
- Telefon einschalten, 17
- Telefonbuch, 18, 21
- Telefonbucheinträge, 12
- Telefonbucheinträge ändern, 22
- Telefonbucheinträge erstellen, 21
- Telefonbucheinträge löschen, 22
- Telefonbuchkapazität prüfen, 22
- Telefonieren, 17
- Texteingabe, 21
- Ton- und Anzeigeeinstellungen, 25

## U

- Uhrzeit einstellen, 7

## V

- Verpackungsinhalt, 6
- VMWI, 30
- Vorwahlnummer, 26

## W

- Wählen, 18
- Wahlpause, 29
- Wahlverfahren, 27, 31
- Wahlwiederholung, 18
- Wahlwiederholungsliste, 23
- Wahlwiederholungsliste löschen, 23
- Warnton Akkukapazität, 25
- Warnton Reichweite, 25
- Wecker, 27
- Wecker stellen, 27
- Weckruf vorzeitig beenden, 27
- Weiterleitung, 19

## Z

- Zeit- und Datumsformat, 25
- Zugangscode, 29
- Zurücksetzen, 26
- Zusatzdienste, 29

1	Consignes de sécurité .....	38
2	Mise en service .....	40
3	Éléments de manipulation .....	42
4	Introduction .....	45
5	Structure de menu .....	47
6	Utilisation .....	51
7	Élargir le système téléphonique .....	62
8	Installations PABX / Services confort .....	63
9	Caractéristiques techniques .....	65
10	Problèmes .....	66
11	Remarques d'entretien / Garantie .....	67
12	Index .....	68

# Consignes de sécurité

## 1 Consignes de sécurité

Lisez très attentivement ce mode d'emploi.

### Utilisation conforme aux prescriptions

Ce téléphone avec combiné convient pour téléphoner à l'intérieur d'un réseau téléphonique. Toute autre utilisation est considérée comme non conforme à son usage. Des modifications ou transformations effectuées de façon arbitraire sont interdites. N'ouvrez en aucun cas l'appareil et n'essayez pas de le réparer vous-même.

### Panne de courant

Dans le cas d'une panne de courant, il n'est pas possible de téléphoner avec cet appareil. En cas d'urgence, prévoyez un téléphone avec fil fonctionnant sans alimentation externe en courant.

### Lieu d'installation

L'endroit où vous le déposez a une influence décisive sur son bon fonctionnement.

Évitez les nuisances causées par la fumée, la poussière, les vibrations, les produits chimiques, l'humidité, la grande chaleur ou un ensoleillement direct. Ne vous servez pas du téléphone dans des endroits exposés aux explosions.

Ne le placez pas à proximité immédiate d'appareils électroniques tels que téléviseurs, radios, microondes, réfrigérateurs, etc., ceci pourrait provoquer une interaction entre votre téléphone et les appareils. Ne le placez pas non plus à proximité d'un autre téléphone. Veillez à ce que des objets de grande taille tels que réfrigérateur ou miroir ne se trouvent pas entre la base et le combiné. Des murs peuvent également exercer une influence sur leur connexion.

Placez le téléphone à proximité d'une prise de courant appropriée et du raccordement téléphonique. Posez le câble de telle sorte que personne ne puisse trébucher à cause de lui.



**Attention :** Ne pas lui mettre de rallonge !

Posez le téléphone sur une surface plane sur laquelle il ne pourra pas glisser. Les pieds du téléphone ne laissent généralement pas de traces sur la surface où il est posé. Cependant, étant donné le nombre de laques et de surfaces utilisées, il se peut qu'ils en laissent.

Plus la base est haut placée (même en intérieur), meilleure est la portée.

### Bloc d'alimentation



**Attention :** N'utilisez que le bloc d'alimentation fourni avec l'appareil, d'autres pouvant endommager le téléphone. Veillez à ce qu'aucun meuble ou autre objet ne bloque l'accès au bloc d'alimentation.

# Consignes de sécurité

## Accus rechargeables



**Attention :** Ne jetez jamais les accus dans le feu. N'utilisez que des accus du même type ! Veillez à ce que la polarité soit correcte ! Risque d'explosion lors de la charge si celle-ci est incorrecte.



**N'utilisez que les accus rechargeables prescrits. Attention : N'utilisez pas de piles. Risque d'explosion !**

## Appareils médicaux



**Attention :** N'utilisez pas le téléphone à proximité d'appareils médicaux. Il n'est pas entièrement exclu qu'il pourrait avoir une influence sur ceux-ci.

## Compatible avec les aides auditives

Ce téléphone est compatible avec la plupart des aides auditives en vente sur le marché. Cependant, un fonctionnement irréprochable ne peut être garanti pour chacune d'entre elles.

Les téléphones **DECT**<sup>1</sup> peuvent causer un bourdonnement désagréable dans les aides auditives.

## Traitement des appareils hors d'usage

Si vous ne voulez plus servir de votre appareil, veuillez l'apporter au centre de collecte de l'organisme de traitement des déchets de votre commune (par ex. centre de recyclage). D'après la loi relative aux appareils électriques et électroniques, les propriétaires d'**appareils électriques et électroniques** hors d'usage sont tenus de les déposer dans un collecteur séparé. L'icône ci-contre signifie que vous ne devez en aucun cas jeter votre appareil dans les ordures ménagères !



### Risque pour l'homme et l'environnement lié aux piles et accus !

Ne jamais ouvrir, endommager, avaler les piles et accus ou faire pénétrer leur contenu dans l'environnement. Ils peuvent contenir des métaux lourds toxiques et nuisibles pour celui-ci. Vous êtes tenus par la loi d'apporter vos piles et accus à un revendeur de piles ainsi qu'à un centre de collecte responsables de leur traitement qui mettent des conteneurs adéquats à disposition. Ce geste écoresponsable est gratuit. L'icône ci-contre signifie que vous ne devez en aucun cas jeter les piles et accus dans les ordures ménagères, mais que vous devez les apporter à un centre de collecte.



Éliminez les **fournitures d'emballage** conformément au règlement local.

<sup>1</sup> **DECT** : Digital Enhanced Cordless Telecommunication = Norme de téléphonie numérique sans fil optimisée

# Mise en service

## 2 Mise en service

### Remarques concernant la sécurité



**Attention** : Avant de mettre votre téléphone en service, lisez impérativement les consignes de sécurité mentionnées au chapitre 1.

### Vérifier le contenu du coffret

Son contenu :

Contenu	Modèle DC 58X			
	DC 581	DC 582 <sup>1</sup>	DC 583 <sup>1</sup>	DC 584 <sup>1</sup>
Base avec bloc secteur	1	1	1	1
Station d'accueil avec bloc secteur	-	1	2	3
Combiné	1	2	3	4
Câble de raccordement téléphonique	1	1	1	1
Accus (AAA 1.2 V NiMH)	2	4	6	8
Guide de l'utilisateur	1	1	1	1

### Mettre le combiné en marche

#### Raccorder la base

Raccordez la base comme représenté sur le croquis. Pour des raisons de sécurité, n'utilisez que le bloc secteur fourni avec l'appareil.

Tenez absolument compte des informations contenues dans le passage «Lieu d'installation»

☞ page 38.

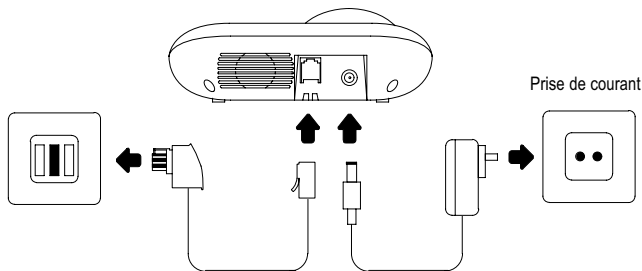

<sup>1</sup> À l'adresse [www.switel.com](http://www.switel.com), vous apprendrez si ce téléphone / kit téléphonique est déjà disponible à la vente.





Utilisez pour la base le bloc secteur présentant les données de sortie 6 VCC, 500 mA.

## Inserer les accus

Le compartiment accus se trouve au dos du combiné. Ouvrez celui-ci et insérez deux accus de type AAA NiMH, 1,2 V 500 mAh. Veillez à ce que la polarité soit correcte ! Refermez le compartiment.

## Recharger les accus



Lors de la première mise en service, laissez le combiné pendant **au moins** 8 heures dans sa station d'accueil.

Si vous avez placé correctement le combiné dans celle-ci, vous entendez un bip de confirmation. Le combiné chauffe pendant la charge. Ceci est normal et sans danger. Utilisez uniquement les chargeurs fournis. Le **niveau de charge actuel des accus** est affiché à l'écran



Plein



Vide

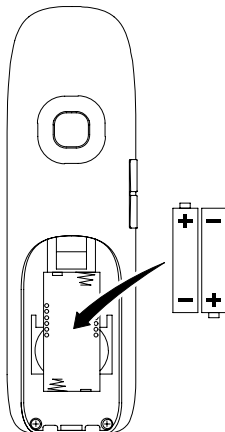

## Programmer la langue de l'écran

Sélectionnez votre langue. La page 49 vous donnera sa position dans le menu.

> Conf. comb. > Langue >...)

9 langues sont disponibles : allemand, français, italien, anglais, espagnol, portugais, néerlandais, polonais et turc.

## Programmer la date et l'heure

Vous programmez la date et l'heure via le menu page 48.

Cofirmez la saisie de l'année, du mois, du jour, de l'heure et de la minute avec la touche . Tenez compte du format de l'heure programmé page 48. Si vous avez programmé le format 12 heures sélectionnez avec les touches / si l'heure programmée signifie avant midi (A) ou après-midi (P).

## Installations PABX

Vous trouverez de plus amples informations à la page 63 si vous désirez raccorder votre téléphone (votre base) à une installation PABX.

## Réduction du rayonnement (mode ÉCO)

Comparé aux téléphones sans fil DECT standard, le rayonnement est considérablement réduit en mode veille quand le combiné repose sur la station d'accueil. En mode de communication, le rayonnement est réduit en fonction de l'éloignement du combiné par rapport au téléphone (à la base).



# Éléments de manipulation

## 3 Éléments de manipulation

Dans ce guide de l'utilisateur, les touches du téléphone sont représentées par des icônes standardisées encadrées. Il peut donc y avoir de légères différences entre les icônes des touches de votre téléphone et celles des touches utilisées ici.





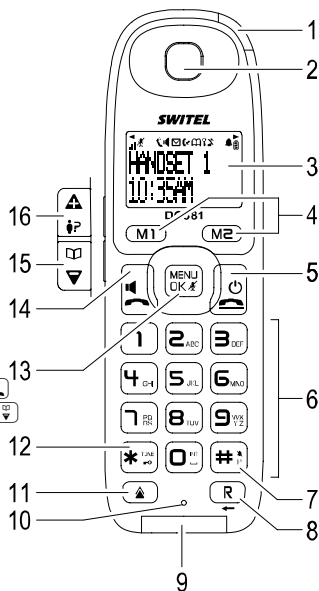







### Combiné

- 1 Signalisation optique d'appel (LED appel)
- 2 Écouteur
- 3 Écran LCD
- 4 Touches de sélection directe M1 M2
- 5 Touche Raccrocher / Éteint
- 6 Pavé numérique 1, 2... 0
- 7 Touche # / Sonn. désact / Pause numérotation ##
- 8 Touche signal R / Retour R
- 9 Signalisation optique d'appel
- 10 Microphone
- 11 Répétition automatique des derniers numéros ▲
- 12 Touche étoile \* \*#
- 13 Touche menu / OK / Muet MENU OK #
- 14 Touche de communication / Mains-libres
- 15 Touche fléchée «vers le bas» / Répertoire ▼
- 16 Touche fléchée «vers le haut» / Journal des appels ▲



# Éléments de manipulation

## Icônes et textes sur l'écran du combiné

Icônes	Description
	Affichage de la capacité de l'accu. Vide : les accus doivent être rechargés. Segments continus : les accus se rechargent ☞ page 41.
	Connexion à la base. Plus il y a de barres affichées, meilleure est la connexion (3 barres maximum).
	Clignote : appel entrant ☞ page 51. Continue : vous téléphonez ☞ page 51.
	Appels en absence. Vous avez de nouveaux appels dans le journal des appels ☞ page 58.
	Vous vous trouvez dans le répertoire ☞ page 55.
	Le contact ou l'affichage continue vers la droite ☞ page 55.
	Le contact ou l'affichage continue vers la gauche ☞ page 55.
	La sonnerie est désactivée ☞ page 54.
	Le microphone est programmé sur muet ☞ page 55.
	Le mode mains-libres est activé ☞ page 54.
	Le verrouillage du clavier est activé ☞ page 51.
	Le réveil est activé ☞ page 60.
	Répondeur dans le réseau téléphonique. <b>VMWI</b> - Service confort de votre opérateur ☞ page 64.

# Éléments de manipulation

## Base

- 1 Contacts de chargement
- 2 Touche de paging 
- 3 Signalisation optique d'appel (LED appel)

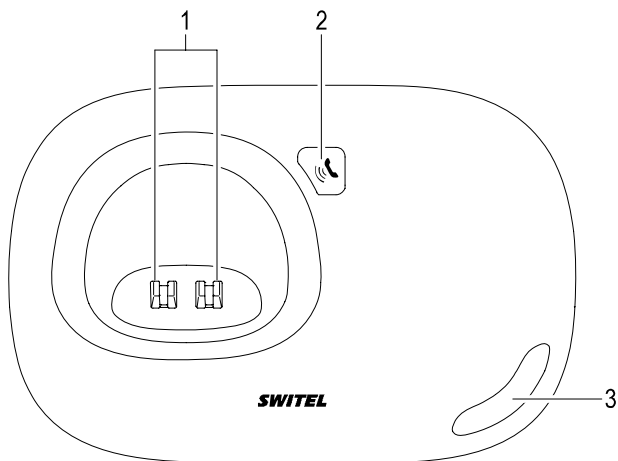

## 4 Introduction

Dans ce chapitre, vous trouverez des informations de base vous expliquant comment vous servir du guide de l'utilisateur.

### Représentation dans le guide

Représentation	Description
	Représentation des touches
	Appuyer brièvement sur la touche représentée
	Appuyer brièvement sur une touche quelconque
2 sec.	Appuyer 2 secondes sur la touche représentée
	Saisir des chiffres ou des lettres
	Le combiné sonne
	Le téléphone sonne
	Retirer le combiné de la base / Décrocher le combiné
	Poser le combiné dans la base / Raccrocher le combiné
	Représentation des textes de l'écran
	Représentation des icônes de l'écran

### Mode veille

Toutes les descriptions contenues dans ce guide partent du principe que le téléphone (la base) et le combiné se trouvent en mode veille. Le téléphone (la base) et le combiné se trouvent en mode veille quand vous ne téléphonez pas et quand aucun menu n'est ouvert.

### Navigation dans le menu

Vous pouvez accéder à toutes les fonctions dans différents menus. La structure de menu vous montre comment accéder à la fonction voulue page 47.







Chaque opération est automatiquement interrompue si vous n'effectuez pas de saisie dans les 20 secondes.

	Ouvrir le menu principal
	Sélectionner l'option voulue
	Ouvrir le sous-menu
	Sélectionner la fonction voulue
	Ouvrir la fonction

<sup>1</sup> Des lettres sont gravées sur les touches numériques. En appuyant plusieurs fois sur la touche adéquate, vous pouvez saisir des lettres, des chiffres et des caractères spéciaux.

# Introduction















	Sélectionner le réglage voulu
	Saisir des chiffres ou des lettres via le pavé numérique
	Confirmer les entrées
	Reculer d'un niveau
	Annuler les actions de programmation et de sauvegarde et retourner en mode veille



De nombreuses saisies terminées avec la touche  sont confirmée par un bip sonore.

## Ajouter des contacts dans le répertoire - exemple

L'exemple **Ajouter des contacts dans le répertoire** (combiné) vous explique ici comment naviguer dans les menus et effectuer des réglages. Procédez comme dans cet exemple pour tous les réglages.

	Ouvrir le menu principal
 <b>Répertoire</b> 	Ouvrir le répertoire
 <b>Ajouter</b> 	Sélectionner le sous-menu et valider
<b>Entrez nom</b>  	Entrer le nom (max. 12 caractères) et valider
<b>Numéro</b>  	Saisir le numéro d'appel 1 (portable) (max. 24 chiffres) et valider
<b>Numéro</b>  	Saisir le numéro 2 (fixe) (max. 24 chiffres) et valider
<b>Mélodie VIP</b> ,  , 	Attribuer une mélodie de sonnerie
	Retourner au mode veille



Vous pouvez sauvegarder 2 numéros de téléphone par nom ou contact. L'icône d'un portable précède la première place de mémoire, l'icône d'une maison précède la deuxième. C'est pourquoi nous recommandons de programmer seulement des numéros de portable pour la première place de mémoire et seulement des numéros de fixe pour la deuxième.

## 5 Structure de menu

Vous parvenez au menu principal en appuyant sur la touche . Ensuite, sélectionnez un contact à l'aide des touches / et validez avec la touche . Pour d'autres informations relatives au menu et à la manipulation, se reporter au chapitre 4.

### Interphone

Combiné 01 à 06 (uniquement si le nombre correspondant de combinés est déclaré)

### Répertoire

Ajouter	
	Entrez nom
	Numéro
	Numéro
	Mélodie VIP 01 / 02 / ... / Désactivé
Modifier	
	Entrez nom
	Numéro
	Numéro
	Mélodie VIP 01 / 02 / ... / Désactivé
Supprimer	
Tout suppr.	
Copier dans	
	M1
	M2
MÉMOIRE	

<sup>1</sup> Des lettres sont gravées sur les touches numériques. En appuyant plusieurs fois sur la touche adéquate, vous pouvez saisir des lettres, des chiffres et des caractères spéciaux.

# Structure de menu

Horl./Réveil

Régl. réveil

Une fois

Désactivé

Activé Entrez heure 

Chaque jour

Désactivé

Activé Entrez heure 

Format date

JJ/MM

MM/JJ

Format heure

24 heures

12 heures



Régl. heure





# Structure de menu

Conf. comb.

Sons comb.	
Volume comb.	05 / ... / 01 / Désactivé
Sonn. ext.	12 / ... / 01
Sonn. int.	12 / ... / 01
Bip touches	Désactivé / Bip / Mélod. sonn.
Pile faible	Activé / Désactivé
Hors portée	Activé / Désactivé
Égaliseur	
	Naturel
	Basses
	Aigus
Contrast.LCD	06 / ... / 01
Nom comb 	
Décroch.auto	Activé / Désactivé
Appel bébé	
	Désactivé
	Activé      Entrez num. 
Verrou. auto	Activé / Désactivé
Langue	(9 langues)

# Structure de menu

Config. base

Effac. VMWI

Associer

Base 1	PIN ? <sup>2</sup>
--------	--------------------

Base 2	PIN ? <sup>2</sup>
--------	--------------------

Base 3	PIN ? <sup>2</sup>
--------	--------------------

Base 4	PIN ? <sup>2</sup>
--------	--------------------

Sélect. base

Base 1
--------

Base 2
--------

Base 3
--------

Base 4
--------

Auto
------

Avancé

Mode numér.	Fréq. voc./ Impulsions
-------------	------------------------

Délai flash	Court / Moyen / Long
-------------	----------------------

Préfixe	
---------	---

Blocage app.	04 / ... / 01  Entrez num. 
--------------	--

Numéro SOS	04 / ... / 01  Entrez num. 
------------	--

Annuler com	Combiné
-------------	---------

Changer PIN	PIN ? 
-------------	---

Réinit.	Confirmer ?
---------	-------------

<sup>2</sup> Le code PIN est réglé en usine sur "0000".

## 6 Utilisation

### Allumer et éteindre le téléphone

Vous ne pouvez pas recevoir d'appels quand le téléphone est éteint.

Les accus ne sont pas consommés quand le téléphone est éteint.



Vous ne pouvez pas passer d'appel d'urgence quand le téléphone est éteint. Il faut d'abord l'allumer, ce qui peut prendre un certain temps.



2 sec.

Allumer le téléphone (en mode veille)



2 sec.

Éteindre le téléphone

### Verrouillage du clavier

Le verrouillage du clavier est censé empêcher que des fonctions soient déclenchées par inadvertance.



1 sec.

Activer le verrouillage du clavier



Lorsque le verrouillage du clavier est activé, vous pouvez comme d'habitude réceptionner des appels entrants.



1 sec.

Désactiver le verrouillage du clavier

Si le verrouillage du clavier est activé, l'icône s'affiche.

Vous pouvez programmer le téléphone de la sorte que le verrouillage du clavier soit activé automatiquement au bout de 90 secondes page 60.

### Téléphoner

#### Prendre un appel

En plus de la sonnerie, la signalisation optique d'appel s'allume à chaque appel.



Prendre un appel

Prendre un appel



Ne placez pas le téléphone qui sonne trop près de votre oreille, vous pourriez endommager votre audition !

Si vous avez activé la prise d'appel automatique, il vous suffit de retirer le combiné de la base pour prendre cet appel page 60.

#### Terminer la communication



Terminer la communication

Terminer la communication

Pour terminer la communication, reposer le combiné sur la base.

#### Téléphoner



Composer le numéro d'appel (max. 24 chiffres)

Composer le numéro d'appel (max. 24 chiffres)



Si la saisie est erronée, effacer le dernier chiffre

Si la saisie est erronée, effacer le dernier chiffre



Composer le numéro

Composer le numéro

# Utilisation



Vous pouvez aussi appuyer d'abord sur la touche , vous obtenez ainsi la tonalité. Les chiffres saisis de votre numéro d'appel (max. 48 chiffres) sont immédiatement composés. La correction individuelle des chiffres du numéro d'appel n'est pas possible quand la communication est établie de cette manière.

## Répétition des derniers numéros

Votre combiné enregistre les 5 derniers numéros composés avec date et heure de l'appel. Si vous souhaitez composer une nouvelle fois les numéros, p. ex. parce que la ligne était occupée ou parce que vous n'avez pas pu atteindre votre correspondant, utilisez la touche de répétition des derniers numéros :



Ouvrir la liste de répétition des derniers numéros et sélectionner un contact



Établir la communication

Le numéro enregistré est automatiquement composé et la communication établie.

## Rappeler des appels entrés

Votre combiné enregistre 40 numéros d'appel dans un journal des appels.



Ouvrir le journal des appels et sélectionner un contact



Établir la communication

## Composer des numéros à partir du répertoire

Vous devez avoir enregistré des numéros dans le répertoire  page 55.



Ouvrir le répertoire et sélectionner le contact



Établir la communication



Pour avoir accès plus rapidement à un contact du répertoire, appuyez, répertoire ouvert, sur la touche avec l'initiale du contact. Le premier contact ayant cette initiale s'affiche et est en surbrillance.

## Composer des numéros avec les touches de sélection directe

Vous devez avoir mémorisé des numéros sur ces touches  page 57.



Établir la communication

Le numéro enregistré est composé automatiquement.

## Communication interne

Vous devez avoir déclaré deux ou plusieurs combinés (CB1, CB2, ...) sur votre téléphone (base) afin de pouvoir téléphoner gratuitement en interne.

### Téléphoner en interne



Introduire une communication interne



Composer le numéro interne du combiné voulu



Prendre une communication interne sur un autre combiné

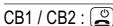

Terminer une communication interne



Si le combiné que vous voulez appeler téléphone en externe, vous entendez un bip et vous voyez sur l'écran Ligne occup.

## Prendre des appels externes pendant une communication interne



Si un appel externe entre pendant que vous téléphonez en interne, un message s'affiche à l'écran.



Prendre la communication externe

Sur le combiné qui n'a pas pris la communication, appuyez sur la touche  pour terminer la communication interne.

## Transférer des communications externes en interne



Interphone



Pendant la communication externe



Composer le numéro interne du combiné voulu

CB2 : 

Prendre une communication interne sur un autre combiné

CB1 : 

Transférer une communication

ou

3 sec. 

Interphone

Pendant la communication externe



Composer le numéro interne du combiné voulu

CB2 : 

Prendre une communication interne sur un autre combiné

CB1 : 

Transférer une communication

## Intercommunication / Va-et-vient



Interphone



Pendant la communication externe



Composer le numéro interne du combiné voulu

CB2 : 

Prendre une communication interne sur un autre combiné



Vat et vient



Changer de correspondant

## Mener des conférences téléphoniques

Une communication externe peut être transformée en conférence téléphonique avec un autre correspondant interne.



Interphone



Pendant la communication externe



Composer le numéro interne du combiné voulu

CB2 : 

Prendre une communication interne sur un autre combiné

CB1: 2 sec. 

Conférence







Conférences téléphoniques

CB1 / CB2 : 

Terminer la conférence

# Utilisation

ou



3 sec. 	Interphone	Pendant la communication externe
 /  , 		Composer le numéro interne du combiné voulu
CB1: 2 sec. 	Conférence	Conférences téléphoniques
CB1 / CB2 : 		Terminer la conférence

## Affichage de la durée de la communication

Quelques secondes après le début de la communication l'écran affiche la durée actuelle de la communication en minutes et secondes.

## Régler le volume du combiné













Pendant une communication vous pouvez régler le volume sonore sur 5 sensibilités.

 / 	Augmenter / Diminuer le volume de l'écouteur
---	--

## Volume de la sonnerie d'appel

### Régler le volume sonore de la sonnerie

Vous pouvez modifier le volume de la sonnerie. Vous pouvez régler le volume sonore sur 5 sensibilités et couper le son.

	Ouvrir le menu
 /  Conf. comb. 	Conf. comb.
 /  Sons comb. 	Sons comb.
 /  Volume comb. 	Volume comb.
 / 	Augmenter / diminuer le volume de la sonnerie
	Enregistrer le réglage

## Activer et désactiver la sonnerie



3 sec. 	Désactiver la sonnerie
3 sec. 	Activer la sonnerie

Vous pouvez également désactiver la sonnerie via le menu.

Si la sonnerie est désactivée, l'icône  s'affiche.

## Mode mains-libres

Utilisez cette fonction pour entendre le correspondant par l'intermédiaire du haut-parleur.

	Activer le mode mains-libres pendant une communication
	Activer le mode mains-libres pendant une communication

Si le mode mains-libres est activé, l'icône  s'affiche.

## Mettre le microphone en mode Muet

Vous pouvez désactiver et activer le microphone pendant une communication de sorte que votre correspondant ne vous entend pas quand vous vous entretenez p. ex. avec une autre personne dans la pièce.

2 sec.	Désactiver le microphone pendant une communication (mode Muet)
2 sec.	Désactiver le microphone pendant une communication

Si le microphone est désactivé, l'icône s'affiche.

## Répertoire

Vous pouvez sauvegarder 50 contacts avec 2 numéros de téléphone chacun dans le répertoire.

- Saisissez toujours les numéros d'appel avec l'indicatif afin que le téléphone puisse aussi attribuer les communications locales entrantes à un contact du répertoire.
- Si la capacité de mémoire est épuisée, l'écran affiche le message suivant **Mém. pleine** . Pour créer de la place, vous devez effacer un autre contact.
- Les contacts du répertoire sont classés par ordre alphabétique.

Si vous vous trouvez dans le répertoire, l'icône s'affiche.

## Saisir un nom

Des lettres sont gravées sur les touches numériques. En appuyant plusieurs fois sur la touche adéquate, vous pouvez saisir des lettres, des chiffres et des caractères spéciaux.

	Entrer des espaces
	Entrer des caractères spéciaux
	Effacer
/	Déplacer le curseur



Pour saisir deux fois la même lettre, appuyez sur la touche correspondante. Attendez que le curseur soit passé derrière la lettre. Puis tapez celle-ci une nouvelle fois.

## Ajouter des contacts dans le répertoire

également page 46

	Ouvrir le répertoire
Ajouter	Sélectionner le sous-menu et valider
Entrez nom ,	Saisir le nom (max. 12 caractères) et valider
Numéro ,	Saisir le numéro d'appel 1 (portable) (max. 24 chiffres) et valider
Numéro ,	Saisir le numéro 2 (fixe) (max. 24 chiffres) et valider
Mélodie VIP  /	Attribuer une mélodie de sonnerie





Si les contacts sont plus longs que l'écran peut les afficher, les icônes et s'affichent. Elles montrent que le contact dépasse l'écran vers la gauche ou vers la droite.

# Utilisation

Si la capacité de mémoire est épuisée, l'écran affiche le message suivant **Mém. pleine**. Pour créer de la place, vous devez effacer un autre contact.

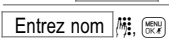
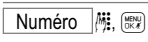
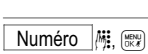

Si un nom existe déjà sous lequel vous voulez enregistrer un nouveau contact, l'écran affiche le message suivant lors de l'enregistrement : **Nom existe**.

## Modifier des enregistrements du répertoire

	Ouvrir le répertoire
	Sélectionner le contact et valider
	Sélectionner le sous-menu et valider
	Saisir le nom (max. 12 caractères) et valider
	Saisir le numéro d'appel 1 (portable) (max. 24 chiffres) et valider
	Saisir le numéro d'appel 2 (fixe) (max. 24 chiffres) et valider
	Attribuer une mélodie de sonnerie

## Effacer des enregistrements du répertoire

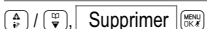

### Effacer un enregistrement

	Ouvrir le répertoire
	Sélectionner le contact et valider
	Sélectionner le sous-menu et valider



Pour avoir accès plus rapidement à un contact du répertoire, appuyez, répertoire ouvert, sur la touche avec l'initiale du contact. Le premier contact ayant cette initiale s'affiche et est en surbrillance.

### Effacer tous les contacts

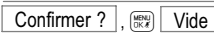
	Ouvrir le répertoire
	Ouvrir le menu
	Sélectionner le sous-menu et valider
	Confirmer l'effacement



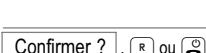

ou

	Annuler l'effacement
---	----------------------















## Vérifier la capacité du répertoire

Consultez combien de contacts sont encore libres sur les 50.

	Ouvrir le répertoire
	Ouvrir le menu
 /  , <b>MÉMOIRE</b> 	Sélectionner le sous-menu et valider

## Programmer les touches de sélection directe

Vous avez la possibilité de mémoriser 2 numéros du répertoire de la sorte que vous puissiez les composer en n'appuyant que sur la touche  ou  (sélection directe).















	Ouvrir le répertoire
 /  , 	Sélectionner le contact et valider
 /  , <b>Copier dans</b> 	Sélectionner le sous-menu et valider
<b>M1</b> ,  /  , 	Sélectionner la touche de sélection directe et valider
	Confirmer le numéro affiché

Composer des numéros avec la touche de sélection directe  page 52.







## Liste de répétition automatique des derniers numéros

Votre combiné enregistre les 5 derniers numéros composés avec date et heure de l'appel.







### Enregistrer dans le répertoire un numéro de la liste des derniers numéros composés

	Ouvrir la liste des derniers numéros composés
 /  , 	Sélectionner le contact et valider
 /  , <b>Enreg. num.</b> 	Sélectionner le sous-menu et valider
<b>Entrez nom</b>  	Saisir le nom (max. 12 caractères) et valider
<b>Entrez num.</b>  	Modifier le cas échéant le numéro d'appel (max. 24 chiffres) et valider
 /  , 	Constater si le numéro est un numéro de portable ou de fixe et valier.

### Effacer un numéro de la liste des derniers numéros composés

	Ouvrir la liste des derniers numéros composés
 /  , 	Sélectionner le contact et valider
 /  , <b>Supprimer</b> 	Sélectionner le sous-menu et valider

### Effacer toute la liste des derniers numéros composés

	Ouvrir la liste des derniers numéros composés
	Ouvrir le menu
 /  , <b>Tout suppr.</b> 	Sélectionner le sous-menu et valider
<b>Confirmer ?</b> ,  <b>Vide</b>	Confirmer l'effacement

# Utilisation

ou

Confirmer ? , R ou  Annuler l'effacement

Composer un numéro de la liste des derniers numéros composés

 Page 52

## Journal des appels



Tous les appels entrant pendant votre absence sont rassemblés dans un journal des appels. Vous pouvez y enregistrer jusqu'à 40 numéros. La date et l'heure de chaque appel sont conservées.

Si vous vous trouvez dans le journal des appels, l'icône  s'affiche.

Le dernier numéro composé s'affiche en premier dans le journal des appels.



Si, pendant votre absence, de nouveaux numéros d'appel ont été enregistrés, la signalisation optique d'appel clignote ainsi que l'icône  à l'écran. L'écran affiche en outre combien vous avez eu d'appels en absence tant que vous n'avez pas ouvert le journal des appels.

## Faire afficher des numéros du journal des appels



 ,  /  Ouvrir le journal des appels et sélectionner un contact

## Sauvegarder dans le répertoire des numéros de la liste d'appels



Vous pouvez enregistrer un numéro dans le répertoire directement de la liste des appels.



 ,  /  Ouvrir le journal des appels et sélectionner un contact

 Ouvrir le menu

 /  **Enreg. num.** ,  Sélectionner le sous-menu et confirmer



**Entrez nom**  ,  Saisir le nom (max. 12 caractères) et valider

**Entrez num.**  ,  Modifier le cas échéant le numéro d'appel (max. 24 chiffres) et valider



 /  ,  Constater si le numéro est un numéro de portable ou de fixe et valier.

## Effacer des numéros du journal des appels

### Effacer des numéros individuels

 ,  /  Ouvrir le journal des appels et sélectionner un contact

 Ouvrir le menu

 /  **Supprimer** ,  Sélectionner le sous-menu et confirmer

### Effacer tous les numéros d'appel

Ouvrir le journal des appels

 Ouvrir le menu

 /  , **Tout suppr.**  Sélectionner le sous-menu et valider

**Confirmer ?** ,  **Vide** Confirmer l'effacement

ou

Confirmer ?



ou



Annuler l'effacement

## Rappel des appels entrés

☞ Page 52

## Réglages du son et de l'affichage

Vous pouvez effectuer différents réglages pour installer le téléphone selon vos besoins :

### Programmer la sonnerie

Fixez pour les appels externes et internes la sonnerie devant toujours utilisée. 12 sonneries polyphoniques sont disponibles.

Programmer la sonnerie ☞ Menu page 49

### Son des touches

Le son des touches vous confirme que vous avez bien appuyé sur la touche. Vous pouvez programmer le téléphone de la sorte qu'en appuyant sur une touche quelconque, vous entendiez toujours le même son (réglage **Bip**) ou des sons différents (réglage **Mélodie**). Le son des touches peut également être désactivé.

Programmer le son des touches ☞ Menu page 49

### Signal d'avertissement de la faible capacité des accus

Un signal d'avertissement vous informe que la capacité des accus est faible.

Programmer le signal d'avertissement de la faible capacité des accus (**Pile faible**)

☞ Menu page 49

### Signal sonore d'avertissement hors de portée

Un signal d'avertissement vous informe que vous vous écartez de la portée de la base.

Régler le signal sonore d'avertissement (**Hors portée**) ☞ Menu page 49

### Égaliseur

Adaptez le son du haut-parleur à votre convenance. Laissez le son **Naturel** ou soulignez les **Basses** ou les **Aigus**.

Régler l'égaliseur ☞ Menu page 49

### Régler le contraste de l'écran

Vous pouvez modifier le contraste de l'écran (**Contrast.LCD**) sur 6 niveaux ☞ Menu page 49

### Nom du combiné

Vous pouvez donner un nom à votre combiné (**Nom comb**) ☞ Menu page 49

### Format de l'heure et de la date

Fixez le format et l'ordre dans lesquels vous voulez voir s'afficher la date et l'heure

☞ Menu page 48

# Utilisation

## Autres réglages

### Prise d'appel automatique

Si vous avez activé cette fonction, l'appel est automatiquement pris lorsque vous retirez le combiné de la base. La prise d'appel automatique s'active ou se désactive via le menu.



Activer la prise d'appel automatique  Menu page 49

### Verrouillage du clavier

Si ce réglage est activé, le verrouillage du clavier est automatiquement activé si vous n'appuyez pas sur une touche quelconque pendant 90 secondes. Si le verrouillage du clavier est activé, l'icône  s'affiche.

Activer le verrouillage du clavier  Menu page 49

### Préfixe

Vous pouvez enregistrer un préfixe (Préfixe). Si vous appuyez un temps long sur la touche  avant ou après avoir entré le numéro, il sera précédé de son préfixe. En appuyant sur la touche  vous composez le numéro.

Modifier le préfixe  Menu page 50

### Modifier le code PIN

Vous avez besoin du code PIN pour déclarer vos combinés. Celui-ci est réglé à l'usine sur le "0000". Modifier le code PIN  Menu page 50

### Remise à zéro

Cette fonction vous permet de remettre votre téléphone aux réglages en usine.

Remise à zéro  Menu page 50

### Chercher le combiné (Paging)

Si vous avez égaré votre combiné, vous pouvez le retrouver facilement grâce à un son de recherche.



Conditions : le combiné est allumé et se trouve à portée de la base. Les accus sont chargés.



Démarrer le son de recherche



Terminer le son de recherche

## Fonctions spéciales

### Réveil

Cette fonction permet que votre combiné vous réveille ou vous rappelle quelque chose à un moment précis. Si le réveil est activé, l'icône  s'affiche. À l'heure de réveil programmée, vous entendrez la sonnerie sélectionnée pendant une minute. Le message Réveil apparaît à l'écran.

### Programmer le réveil

Vous pouvez choisir si vous désirez que le réveil vous réveille une seule fois (Une fois) ou si vous voulez qu'il vous réveille tous les jours (Chaque jour).



Programmer le réveil (Régl. réveil)  Menu page 48

## Terminer prématurément la sonnerie du réveil



Terminer la sonnerie du réveil

## Appel bébé

Cette fonction vous permet de sauvegarder un numéro d'appel précis (max. 24 chiffres) qui sera automatiquement appelé quand vous appuierez sur une touche quelconque (sauf  et .

Si cette fonction est activée, l'affichage clignote en permanence à l'écran **Appel bébé**.

Activer l'appel bébé  Menu page 49

## Blocage d'appel

Le blocage d'appel empêche les combinés de composer des numéros qui commencent avec les chiffres que vous avez enregistrés. Vous pouvez enregistrer 4 numéros bloqués de chacun 8 chiffres.

Activer le blocage d'appel  Menu page 50

## Numéro d'appel d'urgence

Vous pouvez enregistrer jusqu'à 4 numéros d'appel pouvant être composés malgré le blocage d'appel activé. La page 50 vous donnera leur position dans le menu.

## Système de numérotation

Vous pouvez utiliser votre téléphone tant avec les centrales téléphoniques analogiques (numérotation par impulsions / IWW) qu'avec les nouvelles centrales téléphoniques numériques (numérotation par tonalité / MFV). Le système de numérotation est programmé via le menu. La page 50 vous donnera leur position dans le menu.

## Affichage du numéro d'appel (CLIP)



L'affichage des numéros d'appel (CLIP) ainsi que celui de la date et de l'heure sont des services optionnels de votre opérateur. Veuillez lui demander de plus amples informations.

Si votre installation téléphonique dispose de la fonction CLIP (CLIP = Calling Line Identification Presentation), l'écran indique le numéro d'appel du correspondant à l'arrivée d'un appel dans la mesure où ce correspondant est favorable à la transmission de son numéro.



Si vous ne prenez pas l'appel, l'affichage est conservé sur l'écran pendant 6 secondes env. avant de retourner à l'affichage de l'heure et de la date.

# Élargir le système téléphonique

## 7 Élargir le système téléphonique

Le mode standard international normé **GAP**<sup>1</sup> règle de façon standard la compatibilité entre les combinés et les téléphones (bases) de fabricants différents. Il est ainsi possible d'intégrer ensemble des appareils SWITEL et des appareils d'autres fabricants dans un système téléphonique. Il est toutefois possible que certaines fonctions ne soient pas disponibles.





### Plusieurs combinés

Vous pouvez déclarer 6 combinés sur votre téléphone (base).

### Déclarer des combinés

Les combinés sont déclarés par l'intermédiaire du menu du téléphone (de la base). La page 50 vous donnera la position dans le menu.

env. 10 sec.  Pour la déclaration, appuyer sur la touche jusqu'à ce que la signalisation optique d'appel clignote.

 /  /  , **Config. base** ,  Ouvrir le menu

 /  , **Associer** ,  Ouvrir le menu

 /  , **Base x** ,  Sélectionner la base

**PIN ?**  ,  Entrer PIN<sup>2</sup> et valider

Le combiné cherche la base. Ceci peut durer jusqu'à 2 minutes.

Après la déclaration, un numéro d'appel interne est attribué au combiné. Ce numéro interne s'affiche.



Pour déclarer des combinés d'autres fabricants, veuillez lire leur mode d'emploi.

### Annuler des combinés



Vous ne pouvez annuler un combiné d'un téléphone (d'une base) que par un autre, déclaré sur ce téléphone (cette base).

Les combinés sont annulés par l'intermédiaire du menu du téléphone (de la base). La page 50 vous donnera leur position dans le menu.

### Plusieurs bases

Vous pouvez étendre la portée de votre combiné si vous le déclarez sur plusieurs téléphones (bases). Il peut être déclaré simultanément sur 4 téléphones (bases) différents. Chaque téléphone (base) a besoin de sa propre prise téléphonique. Ces raccordements peuvent porter le même numéro d'appel ou bien des numéros différents.



Des communications en cours ne peuvent pas être transférés d'un téléphone à un autre (d'une base à une autre).

<sup>1</sup> **GAP** : Generic Access Profile = Standard pour l'action conjointe de combinés et de bases de fabricants différents.

<sup>2</sup> Le code PIN est réglé en usine sur "0000".

## 8 Installations PABX / Services confort

### Touche R et services confort

Votre téléphone supporte des services confort de votre opérateur tels que le va-et-vient, la signalisation d'appel en instance et la conférence. Vous pouvez les utiliser via la touche **R**. Demandez à votre opérateur le temps de flash à paramétrer pour les utiliser. Contactez ce dernier pour activer ces services. Le temps de flash se paramètre via le menu. La page 50 vous donnera leur position dans le menu.

### Touche R sur des installations PABX

Si votre téléphone est raccordé à une installation PABX, vous pouvez, via la touche **R**, bénéficier de certaines fonctions comme par ex. le transfert d'appels et le rappel automatique. Veuillez lire dans le mode d'emploi de votre installation PABX le temps de flash à paramétrer pour pouvoir utiliser ces fonctions. Le revendeur auprès duquel vous avez acheté l'installation vous informera si votre téléphone fonctionne parfaitement sur celle-ci. Le temps de flash se paramètre via le menu. La page 50 vous donnera leur position dans le menu.

### Code d'accès (Code réseau)

Dans le cas d'installations PABX, il faut composer auparavant un code réseau pour obtenir la tonalité. Souvent, le code réseau est «0» ou «9». Tapez d'abord le code d'accès au réseau et attendez la tonalité. Vous pouvez maintenant entrer le numéro.



Si vous désirez également utiliser les fonctions de sélection directe de votre téléphone sur une installation PABX, assurez-vous que lors de la programmation des touches prévues à cet effet, vous les avez bien fait précéder du code réseau du numéro.

Vous pouvez programmer en outre une pause de numérotation entre le code réseau et le numéro ☞ Passage «Pause de numérotation».

### Pause de numérotation

Dans le cas d'installations PABX, il faut composer auparavant un code réseau pour obtenir la tonalité. Sur quelques installations plus anciennes, vous devez attendre quelques instants avant de pouvoir entendre la tonalité. Pour ces installations PABX, une pause de numérotation peut être insérée après le code réseau afin de pouvoir continuer à composer le numéro directement sans attendre la tonalité. Vous insérez la pause de numérotation en appuyant 3 sec. sur la touche **\*\***. Après le code réseau, le numéro d'appel proprement dit est composé au bout d'un temps déterminé.



La pause peut également être enregistrée lors de la saisie de numéros d'appel dans le répertoire.

# Installations PABX / Services confort

## Affichage du numéro d'appel (CLIP<sup>1</sup>)



L'affichage du numéro d'appel est un service confort de votre opérateur. Veuillez lui demander de plus amples informations.

Si cette fonction est disponible sur votre ligne téléphonique, le numéro d'appel du correspondant sera affiché dès que le téléphone sonnera. Si votre correspondant a bloqué la transmission de son numéro, un message correspondant sera affiché. Le numéro ne peut pas être affiché et ne peut donc être enregistré dans la liste d'appels.

## Répondeur dans le réseau téléphonique

Le répondeur dans le réseau téléphonique est un service confort offert par de nombreux opérateurs. Si votre opérateur met à votre disposition un répondeur dans le réseau téléphonique, vous serez informé par une icône de l'arrivée de nouveaux messages (**VMWI**<sup>2</sup>). Vous ne pouvez disposer de cette fonction que si votre opérateur offre ce service confort. Veuillez lui demander de plus amples informations.

<sup>1</sup> **CLIP** : Calling Line Identification Presentation = Affichage du numéro d'appel d'un correspondant.

<sup>2</sup> **VMWI** : Visual Message Waiting Indication = Affichage optique de nouveaux messages.



# Caractéristiques techniques

## 9 Caractéristiques techniques

Caractéristique	Valeur
Standard	DECT <sup>1</sup> -GAP <sup>2</sup>
Alimentation en courant (base)	Entrée : 100-240 V, 50-60 Hz Sortie : 6 V, 500 mA
Portée	En extérieur : env. 300 m En intérieur : env. 50 m
Autonomie en veille	Jusqu'à 110 h
Durée max. de communication	Jusqu'à 11 h
Volume sonore max. de l'écouteur	30 dB
Accus rechargeables	2 x 1.2 V 500 mAh NiMH, taille : AAA
Système de numérotation	Numérotation par tonalité (FV) ou par impulsions (DC)
Temps de flash	Court, moyen, long
Nombre de sonneries	12 (polyphoniques)
Nombre max. de contacts dans le répertoire	50
Nombre max. de contacts dans le journal des appels	40
Nombre max. de contacts dans la répétition automatique des derniers numéros	5
Langues des menus	Allemand, français, italien, anglais, espagnol, portugais, néerlandais, polonais et turc.

### Déclaration de conformité

Cet appareil répond aux exigences de la directive de l'Union européenne : 1999/5/CE : Directive sur les installations de radio et de télécommunication et la reconnaissance réciproque de leur conformité. La conformité avec la directive mentionnée ci-dessus est confirmée sur l'appareil par la marque CE.



### Ligne d'assistance directe

Si vous avez des problèmes avec votre téléphone, observez d'abord les remarques suivantes. S'il s'agit de problèmes techniques, vous pouvez vous adresser à notre ligne d'assistance directe en Suisse au numéro de tél. 0900 00 1675 (frais Swisscom à la date d'impression de ce manuel : CHF 2,60/min). Si vous jouissez de droits de garantie, adressez-vous à votre revendeur. La durée de la garantie est de 2 ans.

<sup>1</sup> DECT : Digital Enhanced Cordless Telecommunication = Norme de téléphonie numérique sans fil optimisée.

<sup>2</sup> GAP : Generic Access Profile = Standard pour l'action conjointe de combinés et de bases de fabricants différents.

# Problèmes

## 10 Problèmes

Questions	Réponses
Pas de communication téléphonique possible	<ul style="list-style-type: none"><li>- Le téléphone (la base) n'est pas raccordé(e) correctement ou est en dérangement. N'utilisez que le câble de raccordement téléphonique fourni avec l'appareil.</li><li>- Le bloc secteur n'est pas branché ou il y a une panne totale de courant.</li><li>- Testez avec un autre téléphone si votre raccordement téléphonique fonctionne.</li><li>- Mauvais lieu d'installation du téléphone (de la base).</li><li>- Les piles rechargeables sont vides ou défectueuses.</li><li>- Vous vous êtes trop éloigné de la base.</li><li>- Réglage erroné du système de numérotation ☞ page 50.</li><li>- Quand plusieurs combinés sont déclarés : une communication est passée sur un autre combiné.</li><li>- Dans le cas de communications internes : le combiné appelé est en dehors de la portée de la base.</li><li>- Le verrouillage du clavier est activé.</li><li>- Le combiné n'est pas allumé.</li></ul>
Pas de connexion possible au téléphone (base)	<ul style="list-style-type: none"><li>- Contrôlez que vous vous êtes déclaré sur le téléphone (la base) avec le code PIN correct ☞ page 50.</li></ul>
La liaison est hachée, coupée	<ul style="list-style-type: none"><li>- Vous vous êtes trop éloigné de la base.</li><li>- Mauvais lieu d'installation du téléphone (de la base).</li></ul>
Vous entendez des bips pendant une communication téléphonique	<ul style="list-style-type: none"><li>- Vous vous êtes trop éloigné de la base.</li><li>- Les accus sont presque vides.</li></ul>
Le système ne réagit plus	<ul style="list-style-type: none"><li>- Remettez toutes les fonctions en configuration usine ☞ page 50.</li><li>- Retirez le bloc secteur de la prise de courant pendant un court instant.</li></ul>
Les batteries se déchargent très rapidement	<ul style="list-style-type: none"><li>- Celles-ci sont vides ou défectueuses.</li><li>- Posez le combiné correctement sur la base / station d'accueil. Nettoyez les surfaces de contact du combiné et de la base / station d'accueil avec un chiffon doux et sec.</li><li>- Posez le combiné sur la base / station d'accueil pendant 8 heures.</li></ul>
Vous ne pouvez plus recharger les accus	<ul style="list-style-type: none"><li>- Les accus sont défectueux.</li></ul>
L'affichage du numéro d'appel (CLIP) ne fonctionne pas	<ul style="list-style-type: none"><li>- L'affichage du numéro d'appel est un service confort de votre opérateur. Veuillez lui demander de plus amples informations.</li><li>- Le correspondant a bloqué la transmission de son numéro.</li></ul>

## 11 Remarques d'entretien / Garantie

### Remarques d'entretien

- Nettoyez les surfaces du boîtier avec un chiffon doux et non pelucheux.
- N'utilisez pas de produits d'entretien ni de solvants.

À part un nettoyage occasionnel du boîtier, le téléphone ne nécessite pas d'entretien.

### Garantie

Les appareils SWITEL sont fabriqués et contrôlés selon les procédés les plus modernes. Des matériaux sélectionnés et des technologies de haut niveau garantissent un fonctionnement irréprochable et une longue durée de vie. La garantie n'est pas valable si l'exploitant du réseau téléphonique ou une installation PABX éventuellement intercalée est responsable du dysfonctionnement de l'appareil. La garantie ne s'applique pas aux piles et accumulateurs ou packs d'accumulateurs utilisés dans les produits. La durée de la garantie est de 24 mois à partir de la date d'achat.

Pendant la période de garantie, tous les défauts dus à des vices de matériel ou de fabrication seront éliminés gratuitement. Le droit à la garantie expire en cas d'intervention de l'acheteur ou de tiers. Les dommages provenant d'un maniement ou d'une manipulation incorrects, d'une usure naturelle, d'une mauvaise mise en place ou d'une mauvaise conservation, d'un raccordement ou d'une installation incorrects ainsi que d'un cas de force majeure ou autres influences extérieures sont exclus de la garantie. En cas de réclamations, nous nous réservons le droit de réparer, de remplacer les pièces défectueuses ou d'échanger l'appareil. Les composants remplacés ou les appareils échangés deviennent notre propriété. Les demandes de dommages-intérêts sont exclues tant qu'elles ne reposent pas sur l'intention ou une négligence grossière du fabricant.

Si votre appareil devait malgré tout présenter une défectuosité pendant la période de garantie, veuillez vous adresser, muni de votre reçu, exclusivement au magasin où vous avez acheté votre appareil SWITEL. Vous ne pouvez faire valoir vos droits à la garantie selon ces dispositions qu'exclusivement auprès de votre revendeur. Deux ans après l'achat et la remise de nos produits, il n'est plus possible de faire valoir les droits en matière de garantie.

## 12 Index

### A

Accus rechargeables, 39, 65  
Activer et désactiver la sonnerie, 54  
Affichage des numéros d'appel, 58, 64  
Affichage du numéro d'appel (CLIP), 61  
Ajouter des contacts dans le répertoire, 55  
Ajouter un contact, 46  
Alimentation en courant, 65  
Allumer le téléphone, 51  
Annuler un combiné, 62  
Appareils médicaux, 39  
Appel bébé, 61  
Appel d'urgence, 61  
Appels en absence, 58  
Autonomie en veille, 65

### B

Base, 44  
Bloc d'alimentation, 38  
Blocage d'appel, 61

### C

Chercher le combiné, 60  
CLIP, 61, 64  
Code d'accès, 63  
Code réseau, 63  
Combiné, 42  
Communication interne, 52  
Communications internes, 52  
Compatible avec les aides auditives, 39  
Composer des numéros, 52  
Composer un numéro de la liste des derniers numéros composés, 58  
Conférences téléphoniques, 53  
Consignes de sécurité, 38  
Contacts dans le répertoire, 46  
Contenu du coffret, 40

### D

Déclaration de conformité, 65  
DECLARER, 62  
Déclarer un combiné, 62  
DECT, 65  
Désactivation du microphone (Muet), 55  
Durée de la communication, 54, 65

### E

Écran, 43  
Effacer des enregistrements du répertoire, 56  
Effacer des numéros du journal des appels, 58  
Effacer des numéros individuels, 58  
Effacer tous les contacts, 56  
Effacer tous les numéros d'appel, 58  
Effacer toute la liste des derniers numéros composés, 57  
Effacer un enregistrement, 56  
Effacer un numéro de la liste des derniers numéros composés, 57  
Égaliseur, 59  
Élargir le système téléphonique, 62  
Éléments de manipulation, 42  
Enregistrer dans le répertoire un numéro de la liste des derniers numéros composés, 57  
Éteindre le téléphone, 51

### F

Fonctions spéciales, 60  
Format de l'heure et de la date, 59

### G

GAP, 65  
Garantie, 67

### I

Icônes, 43  
Insérer les accus, 41  
Installations PABX, 41, 63  
Intercommunication, 53

## J

Journal des appels, 58

## L

Langues des menus, 65

Lieu d'installation, 38

Ligne d'assistance directe, 65

Liste de répétition automatique des derniers numéros, 57

## M

Menu principal, 47

Mettre le combiné en marche, 40

Mettre le microphone sur muet, 55

Mise en service, 40

Mode ÉCO, 41

Mode mains-libres, 54

Mode veille, 45

Modifier des enregistrements du répertoire, 56

Modifier le code PIN, 60

## N

Navigation dans le menu, 45

Nettoyer, 67

Niveau de charge, 41

Nom du combiné, 59

Nombre de contacts dans  
le journal des appels, 65

Nombre de contacts dans le répertoire, 65

Nombre de sonneries, 65

Nombre max. de contacts dans la répétition  
automatique des derniers numéros, 65

## P

Paging, 60

Panne de courant, 38

Pause de numérotation, 63

Plusieurs bases, 62

Plusieurs combinés, 62

Portée, 65

Préfixe, 60

Prendre des appels externes pendant une  
communication interne, 53

Prendre une communication, 51

Prise d'appel automatique, 60

Problèmes, 66

Programmer l'heure, 41

Programmer la date, 41

Programmer la langue de l'écran, 41

Programmer la sonnerie, 59

Programmer le réveil, 60

Programmer les touches  
de sélection directe, 57

## Q

Que faire des appareils hors d'usage ?, 39

## R

Raccorder la base, 40

Rappel, 52

Rappeler les appels entrés, 52, 59

Recharger les accus, 41

Réduction du rayonnement, 41

Réglages du son et de l'affichage, 59

Régler le contraste de l'écran, 59

Régler le volume du combiné, 54

Régler le volume sonore de la sonnerie, 54

Remarques d'entretien, 67

Remise à zéro, 60

Répertoire, 52, 55

Répétition des derniers numéros, 52

Répondeur dans le réseau téléphonique, 64

Représentation, 45

Réveil, 60

# Index

---

## S

- Saisie de texte, 55
- Saisir le nom, 55
- Sauvegarder, 46, 58
- Sélection directe, 52
- Services confort, 63
- Signal d'avertissement de la faible capacité des accus, 59
- Signal sonore d'avertissement hors de portée, 59
- Son des touches, 59
- Structure de menu, 47
- Système de numérotation, 61, 65

## T

- Téléphoner, 51
- Temps de flash, 65
- Terminer la communication, 51
- Terminer prématurément la sonnerie du réveil, 61
- Touche R, 63
- Transférer des communications, 53
- Transférer des communications externes en interne, 53
- Transfert de communications, 53

## U

- Utilisation, 51
- Utilisation conforme aux prescriptions, 38

## V

- Va-et-vient, 53
- Vérifier la capacité du répertoire, 57
- Verrouillage du clavier, 51, 60
- VMWI, 64
- Volume sonore de l'écouteur, 65

1	Indicazioni di sicurezza . . . . .	72
2	Messa in funzione . . . . .	74
3	Elementi di comando . . . . .	76
4	Informazioni introduttive . . . . .	79
5	Struttura di menu . . . . .	81
6	Funzionamento . . . . .	85
7	Ampliare il sistema telefonico . . . . .	96
8	Impianti telefonici interni / Servizi aggiuntivi	97
9	Specifiche tecniche . . . . .	99
10	Problemi . . . . .	100
11	Consigli per la cura/Garanzia . . . . .	101
12	Indice alfabetico . . . . .	102

# Indicazioni di sicurezza

## 1 Indicazioni di sicurezza

Leggere attentamente le presenti istruzioni per l'uso.

### Impiego conforme agli usi previsti

Il telefono munito di unità portatile consente di eseguire chiamate in una rete telefonica. Qualsiasi altro impiego è considerato non conforme agli usi previsti. Non sono consentite modifiche o trasformazioni non autorizzate. Non aprire per nessuna ragione l'apparecchio autonomamente, né compiere riparazioni di propria iniziativa.

### Caduta di tensione

In caso di caduta di tensione con il telefono non è possibile eseguire chiamate. Ricorrere in caso d'emergenza ad un telefono a filo in grado di funzionare anche senza alimentazione elettrica esterna.

### Luogo di installazione

Il luogo di installazione influisce in modo decisivo sul corretto funzionamento del telefono.

Evitare un'esposizione a fumo, polvere, vibrazioni, sostanze chimiche, umidità, calore e raggi solari diretti. Non utilizzare il telefono in aree esposte al rischio di esplosioni.

Non posizionare il telefono nelle immediate vicinanze di altri dispositivi elettronici come ad es. televisori, forni microonde, frigoriferi e così via in modo da escludere eventuali interferenze reciproche. Evitare di posizionare il telefono in prossimità di un altro telefono. Assicurarsi che grossi oggetti metallici, come ad es. un frigorifero o uno specchio, non si trovino tra stazione base e unità portatile. Anche eventuali pareti possono influire sulla qualità di collegamento tra stazione base e unità portatile.

Posizionare il telefono in prossimità di una presa elettrica idonea e nelle vicinanze della presa telefonica. Fare attenzione a non inciampare sul cavo!



**Attenzione:** Non è consentito prolungare i cavi!

Poggiare il telefono su una superficie piana e antiscivolo. In generale, i piedini del dispositivo non lasciano tracce sulla superficie di appoggio. Vista la molteplicità di vernici e superfici non è comunque possibile escludere che i piedini del dispositivo lascino tracce sulla superficie di appoggio.

Più in alto si posiziona la stazione base (anche all'interno di uno stesso edificio), migliore è la sua portata.

### Alimentatore di rete



**Attenzione:** Utilizzare solo l'alimentatore di rete fornito in dotazione visto che altri alimentatori potrebbero danneggiare il telefono. Non ostacolare il libero accesso all'alimentatore di rete con mobili o altri oggetti simili.



# Indicazioni di sicurezza

## Batterie ricaricabili



**Attenzione:** Non gettare le batterie ricaricabili nel fuoco. Utilizzare solo batterie ricaricabili dello stesso tipo. Osservare la corretta polarità! Pericolo di esplosione in caso di inversione della polarità durante la carica delle batterie ricaricabili.



**Attenzione:** Utilizzare solo le batterie ricaricabili consigliate. Non utilizzare altre batterie o pile. Pericolo di esplosione!

## Apparecchiature mediche



**Attenzione:** Non utilizzare il telefono in prossimità di apparecchiature mediche. Non è possibile escludere il rischio di possibili interferenze.

## Compatibilità con apparecchi acustici

Il telefono è compatibile con il maggior numero di apparecchi acustici presenti sul mercato. Ciò nonostante non è possibile garantire un perfetto funzionamento con qualsiasi tipo di apparecchio acustico.

Telefoni **DECT**<sup>1</sup> possono causare un fastidioso ronzio in apparecchi acustici.

## Smaltimento

Smaltire l'apparecchio consegnandolo presso uno dei punti di raccolta istituiti dalla propria società di smaltimento rifiuti comunale (ad es. centro di riciclo materiali). La legge sugli apparecchi elettrici ed elettronici prescrive ai proprietari di apparecchi esauriti la consegna di tutti gli **apparecchi elettrici ed elettronici** presso un centro di rilievo rifiuti in raccolta differenziata. Il simbolo riportato qui a lato indica che non è assolutamente consentito smaltire l'apparecchio gettandolo nei rifiuti domestici!



**Batterie ricaricabili e pile possono provocare danni alla salute e all'ambiente!**

Non aprire, danneggiare, ingerire o disperdere nell'ambiente batterie ricaricabili e pile. Queste possono contenere metalli pesanti nocivi e dannosi per l'ambiente. Per legge sussiste l'obbligo di smaltire correttamente batterie ricaricabili e pile utilizzando gli appositi contenitori di raccolta in uso presso i rivenditori di batterie. Lo smaltimento è gratuito. I simboli indicano che non è assolutamente consentito gettare batterie ricaricabili e pile nei rifiuti domestici, consegnandoli ai fini dello smaltimento nei rispettivi punti di raccolta.



Smaltire **confezioni ed imballaggi** secondo quanto indicato dalle norme in vigore a livello locale.

<sup>1</sup> DECT: Digital Enhanced Cordless Telecommunication = Standard per telefoni senza cavo

# Messa in funzione

## 2 Messa in funzione

### Indicazioni di sicurezza



**Attenzione:** Prima della messa in funzione, leggere attentamente le indicazioni di sicurezza nel capitolo 1.

### Verificare il contenuto della confezione

La confezione include:

Contenuto	Modello DC 58X			
	DC 581	DC 582 <sup>1</sup>	DC 583 <sup>1</sup>	DC 584 <sup>1</sup>
Stazione base con alimentatore di rete	1	1	1	1
Stazione di carica con alimentatore di rete	-	1	2	3
Unità portatile	1	2	3	4
Cavo di collegamento telefonico	1	1	1	1
Batterie ricaricabili (AAA 1,2 V NiMH)	2	4	6	8
Istruzioni per l'uso	1	1	1	1

### Mettere in funzione l'unità portatile

#### Collegare la stazione base

Procedere al collegamento dell'unità base secondo quanto raffigurato nella figura. Per motivi di sicurezza si prega di utilizzare solo l'alimentatore di rete fornito in dotazione.

Osservare necessariamente le indicazioni relative al luogo di installazione pagina 72.

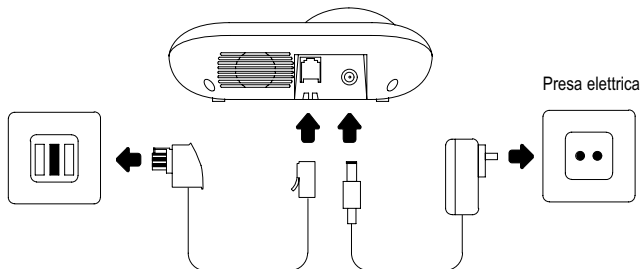

<sup>1</sup> Per maggiori informazioni sulla disponibilità del telefono/set telefonico si prega di visitare il sito [www.switel.com](http://www.switel.com).

# Messa in funzione



Utilizzare per la stazione base l'alimentatore di rete con i dati di output 100-240 Vac 6 Vdc 500 mA fornito in dotazione.

## Inserire le batterie

Il vano batterie si trova sul retro dell'unità portatile. Aprire il vano batterie e inserire 2 batterie ricaricabili tipo AAA NiMH, 1.2 V 500 mAh. Osservare la corretta polarità! Chiudere quindi il vano batterie.

## Caricare le batterie



Riporre l'unità portatile in sede di prima messa in funzione per **minimo 8 ore** nella stazione di carica.

Un segnale acustico indica il corretto posizionamento dell'unità portatile nella stazione di carica. L'unità portatile si surriscalda durante il processo di carica. Questo è un fenomeno normale e non pericoloso. Evitare di caricare l'unità portatile con dispositivi di carica differenti o estranei. L'attuale **stato di carica delle batterie** è visualizzato sul display:



Carico



Scarico

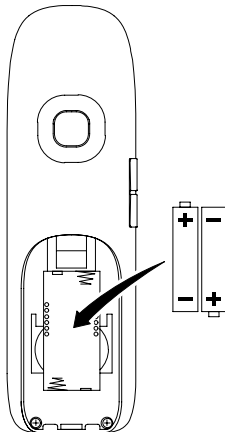

## Impostare la lingua di display





Selezionare la lingua richiesta. A pagina 83 è indicata la posizione da scorrere nel menu.

 > Imp. Ricev. > Lingua >...

È possibile scegliere tra 9 lingue: tedesco, francese, italiano, inglese, spagnolo, portoghese, olandese, polacco e turco.

## Impostare la data e l'ora

Una voce di menu consente l'impostazione di data e ora  pagina 82.

Confermare l'immissione di anno, mese, giorno, ore e minuti rispettivamente con il tasto . Osservare per l'ora il formato impostato  pagina 82. Con formato 12 ore, selezionare con i tasti  /  se l'ora impostata è intesa come ora antimeridiana (A) o pomeridiana (P).

## Impianti telefonici interni

A pagina 97 sono riportate ulteriori informazioni in caso si volesse integrare il proprio telefono (o la stazione base) in un impianto telefonico interno.

## Riduzione delle radiazioni (modalità ECO)

Le radiazioni in modalità di stand-by sono state considerevolmente ridotte se paragonate a quelle emesse da telefoni cordless a standard DECT con unità portatile inserita nella stazione di carica. In modalità di conversazione le radiazioni sono ridotte in relazione alla distanza dell'unità portatile dal telefono (dalla stazione base).



# Elementi di comando

## 3 Elementi di comando

I tasti riportati nelle presenti istruzioni per l'uso sono raffigurati come simboli racchiusi in un riquadro. Sono possibili lievi scostamenti dei simboli dei tasti sul telefono rispetto ai simboli qui raffigurati.

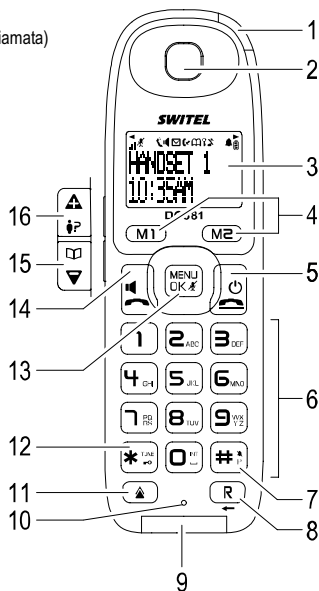

### Unità portatile

- 1 Segnalazione ottica di chiamata (LED di chiamata)
- 2 Ricevitore
- 3 Display LC
- 4 Tasti di selezione diretta (M1) (M2)
- 5 Tasto di riaggancio / Tasto OFF
- 6 Tastierino numerico (1) (2)... (0)
- 7 Tasto # / Segnale di chiamata OFF / Pausa di selezione (\*\*)
- 8 Tasto segnale R / Indietro (R)
- 9 Segnalazione ottica di chiamata
- 10 Microfono
- 11 Ripetizione di chiamata (▲)
- 12 Tasto asterisco (\*)
- 13 Tasto Menu / OK / Mute (MENU/OK)
- 14 Tasto di conversazione / Vivavoce (☎)
- 15 Freccia giù / Rubrica telefonica (▼)
- 16 Freccia su / Elenco chiamate (▲)



# Elementi di comando

## Simboli e testi sul display dell'unità portatile

Simbolo	Descrizione
	Indicazione dello stato di carica delle batterie. Scarico: caricare le batterie. Segmenti che scorrono: le batterie sono in fase di ricarica ➤ pagina 75.
	Collegamento con la stazione base. Più segmenti compaiono, migliore è il collegamento (max. 3 segmenti).
	Lampeggiante: chiamata in arrivo ➤ pagina 85. Costante: chiamata in corso ➤ pagina 85.
	Chiamate perse. Presenza di nuove chiamate nell'elenco chiamate ➤ pagina 92.
	Si è nella rubrica telefonica ➤ pagina 89.
	La voce o indicazione continua ulteriormente a destra ➤ pagina 89.
	La voce o indicazione continua ulteriormente a sinistra ➤ pagina 89.
	Il segnale di chiamata è disattivato ➤ pag. 88.
	Microfono in modalità silenziamento ➤ pagina 89.
	Funzione vivavoce attivata ➤ pag. 88.
	Blocco tastiera attivato ➤ pag. 85.
	Sveglia attivata ➤ pagina 95.
	Segreteria telefonica integrata nella rete telefonica. <b>VMWI</b> - Servizio addizionale del proprio gestore di rete ➤ pagina 98.

# Elementi di comando

---

## Stazione base

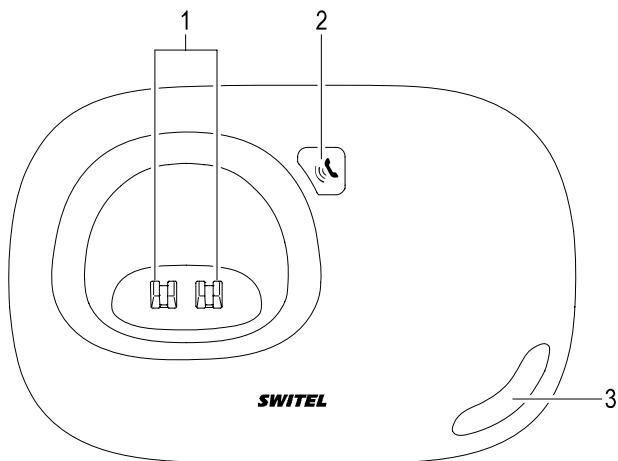

- 1 Contatti di carica
- 2 Tasto di paging 
- 3 Segnalazione ottica di chiamata (LED di chiamata)



## 4 Informazioni introduttive

Il capitolo informa sulle modalità d'uso del presente manuale.

### Modi di rappresentazione nelle istruzioni per l'uso

Simbolo	Descrizione
	Rappresentazione dei tasti
	Premere brevemente il tasto raffigurato
	Premere brevemente un tasto a piacere
2 sec. 	Premere il tasto raffigurato per 2 secondi
	Immettere cifre o lettere
	Unità portatile squilla
	Telefono squilla
	Estrarre l'unità portatile dalla stazione base / Sollevare il ricevitore
	Riporre l'unità portatile nella stazione base / Riattaccare il ricevitore
	Rappresentazione di testi sul display
	Rappresentazione di simboli sul display

### Modalità di stand-by

Nella descrizione d'uso si considerano sempre il telefono (stazione base) e l'unità portatile in modalità di stand-by. Telefono (stazione base) e unità portatile sono in modalità di stand-by quando non si conduce alcuna conversazione e tutti i menu sono chiusi.

### Navigazione nel menu

I vari menu consentono di accedere alle funzioni del telefono. Il percorso da seguire per giungere alla funzione desiderata è indicato dalla struttura di menu  pagina 81.



Ogni processo viene automaticamente interrotto se entro 20 secondi non si procede con una immissione.



Aprire il menu principale



Selezionare il sottomenu richiesto



Aprire il sottomenu



Selezionare la funzione richiesta



Aprire la funzione



Selezionare l'impostazione richiesta

<sup>1</sup> I tasti numerici riportano altresì delle lettere. Premendo ripetutamente il relativo tasto si ha modo di selezionare lettere, cifre e caratteri speciali.

# Informazioni introduttive



Immettere cifre o lettere attraverso il tastierino



Confermare le immissioni



Tornare indietro di un livello



Interrompere le procedure di programmazione e memorizzazione e tornare indietro alla modalità di stand-by



Molte immissioni concluse con il tasto sono ulteriormente confermate da un segnale acustico.

## Creare voci nella rubrica telefonica - Esempio

La navigazione nei menu e la procedura da seguire per compiere impostazioni è indicata a titolo esemplificativo in **Creare voci di rubrica** (unità portatile). Si consiglia di seguire quanto riportato nell'esempio per tutte le impostazioni richieste.



Aprire il menu principale



Rubrica



Aprire la rubrica telefonica



Aggiungi



Selezionare il sottomenu e confermare



Inser. nome



Immettere un nome (max. 12 segni) e confermare



Numero



Immettere il numero di chiamata 1 (numero cellulare) (max. 24 cifre) e confermare



Numero



Immettere il numero di chiamata 2 (numero fisso) (max. 24 cifre) e confermare



Suon.VIP



Assegnare una suoneria



Tornare indietro alla modalità di stand-by



Per ogni nome o voce è possibile memorizzare 2 numeri telefonici. Il primo spazio memoria è preceduto dal simbolo di un cellulare, il secondo spazio memoria dal simbolo di una casa. Si consiglia pertanto di programmare per il primo spazio memoria un numero di cellulare, per il secondo spazio memoria un numero di rete fissa.



## 5 Struttura di menu



Per passare al menu principale, premere il tasto . Selezionare quindi con i tasti  /  una voce e confermare la selezione con il tasto . Maggiori informazioni su menu ed esercizio ➤ capitolo 4.

### Intercom



Cuffie 01 - 06 (solo se si raggiunge il numero di portatili registrati richiesto)

### Rubrica

#### Aggiungi

Inser. nome	 <sup>1</sup>
Numero	
Numero	
Suon.VIP	01 / 02 / ... / Off

#### Modifica

Inser. nome	 <sup>1</sup>
Numero	
Numero	
Suon.VIP	01 / 02 / ... / Off

#### Elimina

Elim. tutto

Copia su

M1

M2

USO

<sup>1</sup> I tasti numerici riportano altresì delle lettere. Premendo ripetutamente il relativo tasto si ha modo di selezionare lettere, cifre e caratteri speciali.

# Struttura di menu

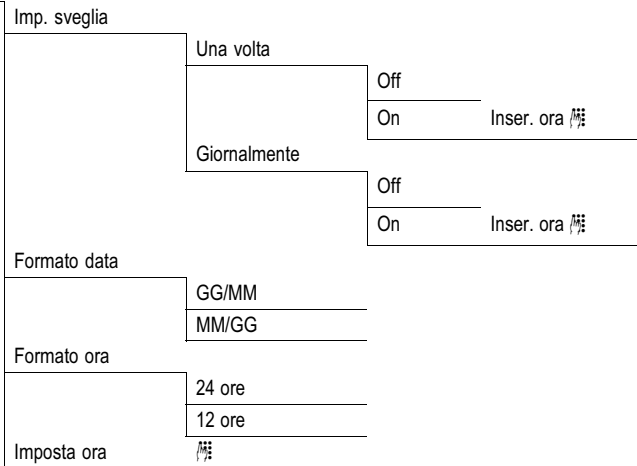

---

Orolog/Svegl



# Struttura di menu

Imp. Ricev.

Suono Ricev	
Volume Suon.	05 / ... / 01 / Off
Suon. est.	12 / ... / 01
Suon. inter	12 / ... / 01
Tono tasti	Off / Tono / Tono suon.
Batt scarica	On / Off
Fuori portat	On / Off
Equalizzat.	
	Naturale
	Bassi
	Acuti
Contrast.LCD	06 / ... / 01
Nome ricev. 	
Auto risp.	On / Off
Chiam.bamb.	
	Off
	On Inser.Numeri 
Bloc.tas.aut	On / Off
Lingua	(9 lingue)

# Struttura di menu

Impost.base

Canc. VMWI

Registra

Base PIN?2

Base PIN?2

Base PIN?2

Base PIN?2

Selez.base

Base

Base

Base

Base

Auto

Avanzato

Mod.composiz Toni / Impulsi

Tempo flash Breve / Medio / Lungo

Prefisso 

Filtro Chiam 04 / ... / 01   
Inser.Numeri 

Numero SOS 04 / ... / 01   
Inser.Numeri 

Canc.registr Cuffie

Cambia Pin PIN? 

Reimposta Confermi?

<sup>2</sup> Il codice PIN è impostato in fabbrica su "0000".

## 6 Funzionamento

### Inserire e disinserire il telefono

Con telefono disinserito non è possibile ricevere chiamate.

Il telefono spento non consuma batterie.



Con telefono disinserito non è possibile svolgere chiamate d'emergenza. Prima di poter fare ciò è indispensabile inserire il telefono, cosa che può richiedere del tempo.



2 sec.

Inserire il telefono (passando in modalità di stand-by)



2 sec.

Disinserire il telefono

### Blocco dei tasti

Il blocco dei tasti impedisce l'attivazione inavvertita di determinate funzioni.



1 sec.

Attivare il blocco dei tasti



L'attivazione del blocco dei tasti consente di ricevere telefonate in arrivo come di consueto.



1 sec.

Disattivare il blocco dei tasti

Con blocco dei tasti attivato, sul display compare il simbolo

Il telefono può essere impostato in modo da attivare il blocco dei tasti automaticamente dopo 90 secondi pag. 94.

### Telefonare

#### Ricevere una chiamata

Oltre allo squillo, ogni telefonata è altresì segnalata da una segnalazione ottica di chiamata.



Accettare la chiamata



Non avvicinare il telefono che squilla troppo all'orecchio visto il pericolo di danni all'udito!

Con ricezione automatica delle chiamate attivata, per accettare la chiamata è sufficiente estrarre l'unità portatile dalla stazione base pag. 94.

#### Concludere la chiamata



Concludere la chiamata

Per concludere una chiamata è anche possibile riporre l'unità portatile nella stazione base.

#### Compiere telefonate



Immettere un numero di chiamata (max. 24 cifre)



In caso di immissione errata, cancellare l'ultima cifra



Selezionare un numero di chiamata



È altresì possibile premere prima il tasto e ottenere il segnale di linea libera. Il telefono seleziona immediatamente le cifre immesse per la composizione del numero di chiamata desiderato (max. 48 cifre). Nel corso di una simile chiamata non è possibile eseguire la correzione di singole cifre che compongono il numero di chiamata.

# Funzionamento

## Ripetizione di chiamata

L'unità portatile memorizza l'ultimo numero di chiamata selezionato assieme alla data e all'ora della telefonata. Per riselectare questo numero telefonico, ad es. perché la linea è risultata precedentemente occupata o perché non si è raggiunto nessuno, è possibile utilizzare la funzione ripetizione di chiamata:



Aprire l'elenco di ripetizione di chiamata e selezionare una voce



Instaurare un collegamento

Il numero telefonico memorizzato è selezionato automaticamente instaurando un collegamento.

## Richiamare una chiamata persa

L'unità portatile memorizza 40 numeri telefonici in un elenco chiamate.



Aprire l'elenco chiamate e selezionare una voce



Instaurare un collegamento

## Selezionare numeri telefonici dalla rubrica

Per fare questo è necessario aver precedentemente memorizzato dei numeri nella rubrica telefonica  pag. 89.



Aprire la rubrica e selezionare una voce



Instaurare un collegamento



Per poter accedere più velocemente ad una voce in rubrica, premere con rubrica aperta la lettera iniziale della voce richiesta. Sul display compare la prima voce con la lettera indicata.

## Selezionare numeri telefonici tramite tasti di selezione diretta

La funzione prevede la precedente memorizzazione di numeri telefonici sui tasti di selezione diretta  pag. 91.

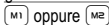

Instaurare un collegamento

Il numero di chiamata memorizzato è selezionato automaticamente.

## Compiere chiamate interne

Per poter svolgere telefonate interne gratuite bisogna aver registrato due o più unità portatili (UP1, UP2, ...) al proprio telefono (alla propria stazione base).

### Compiere chiamate interne



Avviare la chiamata interna



Selezionare il numero dell'unità portatile richiesta



Accettare una telefonata interna presso l'altra unità portatile

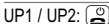

Concludere la telefonata interna



In caso l'unità portatile che si intende chiamare stia svolgendo una telefonata, nella linea si avverte un segnale acustico e sul display compare Linea occup.

## Accettare una chiamata esterna con telefonata interna in corso



In caso di arrivo di una telefonata esterna durante lo svolgimento di una chiamata interna, sul display viene visualizzato un messaggio.



Accettare una chiamata esterna

Per concludere la chiamata interna sul portatile che ha accettato la telefonata esterna, premere il tasto

## Trasferire internamente chiamate interne



**Intercom**,

Con chiamata esterna in corso



Selezionare il numero dell'unità portatile richiesta

UP2:

Accettare una telefonata interna presso l'altra unità portatile

UP1:

Trasferire la chiamata

o

3 sec.

**Intercom**

Con chiamata esterna in corso



Selezionare il numero dell'unità portatile richiesta

UP2:

Accettare una telefonata interna presso l'altra unità portatile

UP1:

Trasferire la chiamata

## Riscontro / Chiamata in attesa



**Intercom**,

Con chiamata esterna in corso



Selezionare il numero dell'unità portatile richiesta

UP2:

Accettare una telefonata interna presso l'altra unità portatile



**Alternare**,

Passare da un interlocutore all'altro

## Condurre chiamate in conferenza

Questa funzione consente di condurre una conferenza con una chiamata esterna e un ulteriore interlocutore interno.



**Intercom**,

Con chiamata esterna in corso



Selezionare il numero dell'unità portatile richiesta

UP2:

Accettare una telefonata interna presso l'altra unità portatile

UP1: 2 sec.

**Conferenza**





Avviare una chiamata in conferenza

UP1 / UP2:

Concludere la chiamata in conferenza

# Funzionamento

0

3 sec.  <b>Intercom</b>	Con chiamata esterna in corso
 /  , <b>MENÙ OK #</b>	Selezionare il numero dell'unità portatile richiesta
UP1: 2 sec.  , <b>Conferenza</b>	Avviare una chiamata in conferenza
UP1 / UP2: 	Concludere la chiamata in conferenza

## Visualizzare la durata di conversazione

Trascorsi alcuni secondi dall'inizio di una conversazione, sul display viene visualizzata la durata di conversazione attuale in minuti e secondi.

## Impostare il volume del ricevitore









Anche con chiamata in corso è possibile regolare il volume del ricevitore in 5 livelli.

 / 	Aumentare/Ridurre il volume del ricevitore
---	--

## Volume dello squillo di chiamata

### Impostare il volume dello squillo di chiamata

Il volume dello squillo di chiamata è impostabile in 5 livelli.

<b>MENÙ OK #</b>	Aprire il menu
 /  <b>Imp. Ricev.</b> <b>MENÙ OK #</b>	Selezionare Imp. Ricev.
 /  <b>Suono Ricev</b> <b>MENÙ OK #</b>	Selezionare Suono Ricev
 /  <b>Volume Suon.</b> <b>MENÙ OK #</b>	Selezionare Volume Suon.
 / 	Aumentare/Ridurre il volume dello squillo di chiamata
<b>MENÙ OK #</b>	Salvare le impostazioni

## Disattivare e attivare lo squillo di chiamata



3 sec. <b>**#</b>	Disattivare lo squillo di chiamata
3 sec. <b>**#</b>	Attivare lo squillo di chiamata

Lo squillo di chiamata si lascia disattivare tramite menu.

Con squillo di chiamata disattivato, sul display compare il simbolo .

## Funzione vivavoce

Utilizzare questa funzione per ascoltare il partner di chiamata attraverso l'altoparlante.



	Con chiamata in corso: attivare la funzione vivavoce
	Con chiamata in corso: disattivare la funzione vivavoce

Con funzione vivavoce attivata, sul display compare il simbolo .



## Silenziamento del microfono

Con chiamata in corso è possibile attivare o disattivare il microfono del portatile, di modo che l'interlocutore non vi sente in caso di consultazione di un'altra persona presente sul luogo.

2 sec. 	Con chiamata in corso: disattivare il silenziamento del microfono (mute)
2 sec. 	Con chiamata in corso: attivare il microfono

Con microfono muto, sul display compare il simbolo .

## Rubrica telefonica





Nella rubrica telefonica è possibile memorizzare 50 interlocutori con ciascuno 2 numeri telefonici.

- Assegnare a tutti i numeri di chiamata sempre un prefisso in modo da poter riconoscere anche una chiamata urbana in arrivo ed abbinarla ad una voce presente nella rubrica telefonica.
- Con capacità di memoria esaurita, sul display compare l'indicazione **Mem piena** dopo aver memorizzato l'ultimo messaggio. Per poter disporre di nuovo spazio memoria, cancellare prima una voce già presente.
- Le voci della rubrica telefonica sono elencate in ordine alfabetico.

Se ci si trova nella rubrica telefonica, sul display compare il simbolo .

## Inserire nomi

I tasti numerici riportano altresì delle lettere. Premendo ripetutamente il relativo tasto si ha modo di selezionare lettere, cifre e caratteri speciali.





	Immettere spazi vuoti
	Immettere caratteri speciali
	Cancellare
	Spostare il cursore



Per immettere la stessa lettera una seconda volta, premere il rispettivo tasto. Attendere finché il cursore si sposta di una posizione. Immettere quindi la lettera una seconda volta.

## Creare voci di rubrica

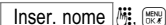
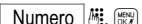
 anche pag. 80

	Aprire la rubrica telefonica
	Selezionare il sottomenu e confermare
	Immettere un nome (max. 12 segni) e confermare
	Immettere il numero di chiamata 1 (numero cellulare) (max. 24 cifre) e confermare
	Immettere il numero di chiamata 2 (numero fisso) (max. 24 cifre) e confermare
	Assegnare uno squillo

# Funzionamento

















Se le voci sono più lunghe dello spazio di display disponibile, sul display sono visualizzati i simboli ◀ e ▶. In questo modo si viene informati che la voce continua oltre il display a sinistra o a destra.

Con capacità di memoria esaurita, sul display compare l'indicazione **Mem piena** dopo aver memorizzato l'ultimo messaggio. Per poter disporre di nuovo spazio memoria, cancellare prima una voce già presente.

Se il nome immesso è già presente in rubrica, sul display compare l'indicazione







**Doppio nome**.

## Modificare voci in rubrica

	Aprire la rubrica telefonica
 /  , 	Selezionare la voce e confermare
 /  , <b>Modifica</b> , 	Selezionare il sottomenu e confermare
<b>Inser. nome</b> ,  , 	Modificare il nome (max. 12 cifre) e confermare
<b>Numero</b> ,  , 	Modificare il numero di chiamata 1 (numero cellulare) (max. 24 cifre) e confermare
<b>Numero</b> ,  , 	Modificare il numero di chiamata 2 (numero fisso) (max. 24 cifre) e confermare
<b>Suon.VIP</b> ,  /  , 	Assegnare uno squillo

## Cancellare voci in rubrica









### Cancellare una voce

	Aprire la rubrica telefonica
 /  , 	Selezionare la voce e confermare
 /  , <b>Elimina</b> , 	Selezionare il sottomenu e confermare



Per poter accedere più velocemente ad una voce in rubrica, premere con rubrica aperta la lettera iniziale della voce richiesta. Sul display compare la prima voce con la lettera indicata.

### Cancellare tutte le voci

	Aprire la rubrica telefonica
	Aprire il menu
 /  , <b>Elim. tutto</b> , 	Selezionare il sottomenu e confermare
<b>Confermi?</b> ,  <b>Vuoto</b>	Confermare la procedura di cancellazione
<b>Confermi?</b> ,  oppure 	Interrompere la procedura di cancellazione

## Verificare la memoria di rubrica

Il dispositivo visualizza il numero di posizioni di memoria libere dei 50 posti disponibili.

	Aprire la rubrica telefonica
	Aprire il menu
/  , <b>USO</b>	Selezionare il sottomenu / confermare

## Programmare i tasti di selezione diretta

2 numeri telefonici presenti in rubrica possono essere programmati in modo da venire selezionati premendo semplicemente il tasto **M1** oppure **M2** (selezione diretta).

	Aprire la rubrica telefonica
/  ,	Selezionare la voce e confermare
/  , <b>Copia su</b>	Selezionare il sottomenu e confermare
<b>M1</b> ,  /  ,	Selezionare il tasto di selezione diretta e confermare
	Confermare il numero telefonico visualizzato

Selezionare il numero telefonico tramite tasto di selezione diretta pag. 86.

## Elenco di ripetizione di chiamata

L'unità portatile memorizza l'ultimo numero di chiamata selezionato assieme alla data e all'ora della telefonata.

## Memorizzare in rubrica un numero dall'elenco di ripetizione di chiamata

	Aprire l'elenco di ripetizione di chiamata
/  ,	Selezionare la voce e confermare
/  , <b>Salva numero</b>	Selezionare il sottomenu e confermare
<b>Inser. nome</b>	Immettere un nome (max. 12 segni) e confermare
<b>Inser. Numeri</b>	Modificare se occorre il numero (max. 24 cifre) e confermare
/  ,	Definire se si tratta di un numero di cellulare o di un numero di telefono fisso e confermare

## Cancellare un numero dall'elenco di ripetizione di chiamata

	Aprire l'elenco di ripetizione di chiamata
/  ,	Selezionare la voce e confermare
/  , <b>Elimina</b>	Selezionare il sottomenu e confermare

## Cancellare tutto l'elenco di ripetizione di chiamata

	Aprire l'elenco di ripetizione di chiamata
	Aprire il menu
/  , <b>Elim. tutto</b>	Selezionare il sottomenu e confermare
<b>Confermi?</b> , <b>Vuoto</b>	Confermare la procedura di cancellazione

# Funzionamento

0

 ,  oppure  Interrompere la procedura di cancellazione

Selezionare un numero dall'elenco di ripetizione di chiamata

 pag. 86

## Elenco chiamate

In caso di assenza tutte le chiamate giunte sono memorizzate in un apposito elenco chiamate. In tutto è possibile memorizzare fino a 40 numeri di chiamata. Con ogni numero telefonico sono altresì memorizzate data e ora della chiamata.

Se ci si trova nell'elenco chiamate, sul display compare il simbolo .

Nell'elenco chiamate, l'ultimo numero perso è indicato come primo numero in lista.

In presenza di chiamate perse, la segnalazione ottica di chiamata lampeggia e sul display compare il simbolo . Sul display risulta in più anche un'indicazione relativa al numero di chiamate perse, perlomeno fintanto che non si apre la prima volta l'elenco chiamate.

## Visualizzare numeri dall'elenco chiamate



 ,  /  Aprire l'elenco chiamate e selezionare una voce

## Memorizzare in rubrica un numero dall'elenco chiamate



È possibile memorizzare un numero di chiamata direttamente dall'elenco chiamate nella rubrica telefonica.



 ,  /  Aprire l'elenco chiamate e selezionare una voce

 /  Aprire il menu

 /  **Salva numero** ,  Selezionare il sottomenu e confermare

**Inser. nome**  /  Immettere un nome (max. 12 segni) e confermare

**Inser. Numeri**  /  Modificare se occorre il numero (max. 24 cifre) e confermare



 /  ,  Definire se si tratta di un numero di cellulare o di un numero di telefono fisso e confermare

## Cancellare numeri dall'elenco chiamate

### Cancellare singoli numeri di chiamata

 ,  /  Aprire l'elenco chiamate e selezionare una voce



 /  Aprire il menu

 /  **Elimina** ,  Selezionare il sottomenu e confermare

### Cancellare tutti i numeri di chiamata

 /  Aprire l'elenco chiamate

 /  Aprire il menu

 /  , **Elim. tutto**  Selezionare il sottomenu e confermare

**Confermi?** ,  **Vuoto** Confermare la procedura di cancellazione

0

Confermi?

R

oppure 

Interrompere la procedura di cancellazione

## Riselezionare chiamate ricevute

☞ pag. 86

## Impostazione di toni e indicazioni

Varie opzioni di impostazione consentono di adattare il telefono alle proprie esigenze:

### Impostare lo squillo di chiamata

Si prega di definire uno squillo per chiamate esterne e interne. In tutto è possibile scegliere tra 12 squilli polifonici.

Impostare lo squillo di chiamata ☞ Menu pag. 83

### Suono dei tasti

I suoni dei tasti danno conferma di aver effettivamente premuto il tasto interessato. Il telefono si lascia impostare in modo che premendo un qualsiasi tasto si avverta sempre lo stesso tono (impostazione Tono), oppure toni sempre diversi (impostazione Suoneria). In più è anche possibile disattivare il suono dei tasti.

Impostare il suono dei tasti ☞ Menu pag. 83

### Suono di avviso del livello di carica delle batterie

Un segnale acustico informa sul basso livello di carica delle batterie.

Impostare il segnale acustico del livello di carica delle batterie (Batt scarica) ☞ Menu pag. 83

### Suono di avviso di portata

Un segnale acustico informa che l'unità portatile si trova fuori della portata della stazione base.

Impostare il segnale acustico di portata (Fuori portat) ☞ Menu pag. 83

### Equalizzatore

La qualità del suono dell'altoparlante può essere adattata alle proprie esigenze. Lasciare il suono Naturale oppure mettere in evidenza i Bassi o gli Acuti.

Impostare l'equalizzatore ☞ Menu pag. 83

### Contrasto di display

Il contrasto del display (Contrast.LCD) è regolabile in 6 livelli ☞ Menu pag. 83

### Nome del portatile

Al portatile può essere assegnato un nome individuale (Nome ricev.) ☞ Menu pag. 83

### Formato di ora e data

Il telefono consente di definire il formato e l'ordine di immissione riferiti a ora e data

☞ Menu pag. 82

# Funzionamento

## Impostazioni varie

### Ricezione automatica di chiamate

L'attivazione di questa funzione consente di ricevere automaticamente una chiamata estraendo semplicemente l'unità portatile dalla stazione base. L'accettazione di chiamata automatica è attivata o disattivata nel menu.



Attivare l'accettazione automatica di chiamata ➤ Menu pag. 83

### Blocco dei tasti

Con impostazione attivata, il blocco dei tasti si attiva automaticamente se non si preme alcun tasto per 90 secondi. Con blocco dei tasti attivato, sul display compare il simbolo .

Attivare il blocco dei tasti ➤ Menu pag. 83

### Prefisso

È possibile impostare un prefisso (Prefisso). Premendo a lungo il tasto  prima o dopo l'immissione di un numero di chiamata, il prefisso andrà a precedere il numero interessato. Premendo il tasto  il numero di chiamata è selezionato.

Modificare il prefisso ➤ Menu pag. 84

### Modificare il PIN

Il codice PIN è necessario alla registrazione di unità portatili. La configurazione iniziale del codice è "0000". Modificare il PIN ➤ Menu pag. 84

### Reset

La funzione consente di ripristinare la configurazione iniziale del telefono.

Reset ➤ Menu pag. 84

## Cercare l'unità portatile (funzione di paging)

Avendo perso d'occhio la propria unità portatile è possibile ritrovarla facilmente grazie all'emissione di un tono di ricerca.



Requisito: l'unità portatile deve risultare inserita e trovarsi entro la portata della stazione base. Le batterie non devono essere scariche.



Avviare il tono di ricerca



Concludere il tono di ricerca

## Funzioni speciali

### Sveglia

Con la funzione è possibile farsi svegliare/rilasciare un allarme dalla propria unità portatile all'orario precedentemente impostato. Con sveglia attivata, sul display compare il simbolo . Una volta raggiunto l'orario di sveglia, il telefono emette lo squillo di chiamata per 1 minuto. Sul display compare l'indicazione Allarme.

### Impostare la sveglia

È possibile definire se utilizzare la sveglia per un solo giorno (Una volta) oppure se si vuole essere svegliati allo stesso orario più volte (Giornalmente).



Impostare la sveglia (Imp. sveglia)  Menu pag. 82

### Disattivare la sveglia anzitempo



Disattivare la sveglia

### Funzione baby controllo

La funzione consente di memorizzare un determinato numero telefonico (max. 24 cifre) chiamato automaticamente non appena si aziona un qualsiasi tasto (tranne i tasti  e ).

Con funzione attivata, sul display lampeggia in modo permanente l'indicazione Chiam.bamb..

Attivare il baby controllo  Menu pag. 83

### Blocco di chiamata

Il blocco di chiamata impedisce di selezionare sull'unità portatile numeri telefonici che iniziano con le cifre predefinite. È prevista la memorizzazione di 4 numeri bloccabili composti da rispettivamente max. 8 cifre.

Attivare il blocco di chiamata  Menu pag. 84

### Numero d'emergenza

È prevista la memorizzazione di fino a 4 numeri di chiamata selezionabili nonostante la precedente attivazione del blocco di chiamata. A pag. 84 è indicata la posizione da scorrere nel menu.

### Procedura di selezione

L'unità portatile è utilizzabile sia in sistemi telefonici analogici (procedura di selezione a impulsi / IWV) sia se integrata in moderni sistemi telefonici digitali (procedura di selezione a toni / MFV). La procedura di selezione è impostata tramite menu. A pag. 84 è indicata la posizione da scorrere nel menu.

### Visualizzare il numero di chiamata (CLIP)



La visualizzazione del numero di chiamata (CLIP) e la visualizzazione di data e ora sono servizi del proprio gestore di rete. Si consiglia di rivolgersi direttamente al proprio gestore di rete per ulteriori informazioni a riguardo.

Se il proprio impianto telefonico è abilitato alla funzione CLIP (CLIP = Calling Line Identification Presentation), il display visualizza in caso di chiamata in arrivo il numero di chiamata dell'interlocutore, qualora questi abbia acconsentito alla trasmissione del proprio numero telefonico.



Se non si accetta una chiamata, il display rimane illuminato per ca. 6 secondi, prima che vengano quindi di nuovo visualizzati data e ora attuali.

# Ampliare il sistema telefonico

## 7 Ampliare il sistema telefonico

Lo standard internazionale **GAP**<sup>1</sup> regola la compatibilità di unità portatili e telefoni (stazioni base) di costruttori differenti. In tal modo è possibile adoperare apparecchi **SWITEL** in combinazione con apparecchi di altri costruttori all'interno di un unico sistema telefonico. Ciò nonostante può comunque anche verificarsi che determinate funzioni non siano disponibili.

### Più unità portatili

È possibile registrare fino a 6 unità portatili al proprio telefono (alla stazione base).

### Registrare unità portatili

Le unità portatili sono registrate tramite il menu del telefono (della stazione base). A pagina 84 è indicata la posizione da scorrere nel menu.

ca. 10 sec. 

Per la procedura di registrazione premere il tasto finto che la segnalazione ottica di chiamata del telefono lampeggia.

 /  /  , **Impost.base** ,  Aprire il menu

 /  , **Registra** ,  Aprire il menu

 /  , **Base x** ,  Selezionare la base

**PIN?**  ,  Immettere e confermare il PIN<sup>2</sup>

L'unità portatile cerca la stazione base. Questa procedura può richiedere fino a 2 minuti.

Una volta eseguita la registrazione, all'unità portatile è assegnato un numero di chiamata interno. Questo numero di chiamata interno è visualizzato sul display.



Per registrare unità portatili di altri costruttori, leggere prima le rispettive istruzioni per l'uso.

### Annullare la registrazione di unità portatili



È possibile deregistrare un'unità portatile dal telefono (dalla stazione base) solo utilizzando un'ulteriore unità portatile registrata presso il telefono (la stazione base) interessato.

Le unità portatili sono deregistrate tramite il menu del telefono (della stazione base). A pagina 84 è indicata la posizione da scorrere nel menu.

### Più stazioni base

La portata della propria unità portatile può essere aumentata registrando il dispositivo ad un numero maggiore di telefoni (stazioni base). In tutto si può essere registrati contemporaneamente presso 4 telefoni (stazioni base) diversi. Ogni telefono (stazione base) richiede una presa telefonica autonoma. Si può trattare di allacciamenti con lo stesso o differente numero di chiamata.



Chiamate in corso sono trasferibili da un telefono all'altro (da una stazione base all'altra).

<sup>1</sup> **GAP**: **Generic Access Profile** = Standard per l'interazione di unità portatili e stazioni base di altri costruttori.

<sup>2</sup> Il codice PIN è impostato in fabbrica su "0000".



# Impianti telefonici interni / Servizi aggiuntivi

## 8 Impianti telefonici interni / Servizi aggiuntivi

### Tasto R e servizi aggiuntivi

Il telefono supporta servizi aggiuntivi offerti dal proprio gestore di rete telefonica come ad es. le funzioni di chiamata in attesa, avviso di chiamata e chiamata in conferenza. Il tasto **R** consente di accedere ai servizi aggiuntivi. Il proprio gestore di rete telefonica fornisce informazioni sul tempo flash necessario all'utilizzo dei servizi aggiuntivi e sui requisiti di abilitazione ai servizi aggiuntivi. Il tempo flash è impostato tramite menu. A pagina 84 è indicata la posizione da scorrere nel menu.

### Tasto R in impianti telefonici interni

Con telefono integrato in un impianto telefonico interno, premendo il tasto **R** è possibile usufruire di funzioni come ad es. inoltro di chiamate e richiamata automatica. Consultare le istruzioni per l'uso del proprio impianto telefonico interno per individuare il tempo flash richiesto. Il rivenditore autorizzato è in grado di indicare se il telefono acquistato funzionerà senza alcun problema nel proprio impianto telefonico interno. Il tempo flash è impostato tramite menu. A pagina 84 è indicata la posizione da scorrere nel menu.

### Codice di accesso (numero di accesso alla rete esterna)

In presenza di impianti telefonici interni è necessario preselezionare un numero di accesso alla rete esterna per ottenere un segnale di linea libera prima di poter compiere una telefonata. Spesso il numero di accesso alla rete esterna è uno "0" o un "9". Digitare prima il numero di accesso alla rete esterna, attendere il segnale di linea libera. A questo punto è possibile inserire il numero di chiamata vero e proprio.



Volendo utilizzare la funzione di selezione diretta anche in un impianto telefonico interno, tenere conto durante la programmazione dei tasti di selezione diretta del numero di accesso alla rete esterna che è necessario inserire prima del numero telefonico.

Tra numero di accesso alla rete e numero telefonico è altresì possibile prevedere una pausa di selezione ➔ sezione "Pausa di selezione".

### Pausa di selezione

In presenza di impianti telefonici interni è necessario preselezionare un numero di accesso alla rete esterna per ottenere un segnale di linea libera prima di compiere una telefonata. Alcuni impianti telefonici interni di vecchia data richiedono del tempo prima di trasmettere il segnale di linea libera. Per questi impianti telefonici interni è possibile inserire una pausa di selezione dopo il numero di accesso alla linea esterna in modo da poter proseguire con la selezione del numero senza dover attendere il segnale di libero. Per inserire la pausa di selezione, premere e tenere premuto per 3 sec. il tasto **\*\*#**.

Dopo il numero di accesso alla rete esterna si procede, trascorso un determinato intervallo di tempo, con la selezione del numero di chiamata vero e proprio.



La pausa di selezione si può memorizzare anche durante l'immissione di numeri di chiamata nella rubrica telefonica.

# Impianti telefonici interni / Servizi aggiuntionali

## Visualizzare il numero di chiamata (CLIP<sup>1</sup>)



La visualizzazione del numero di chiamata è un servizio aggiuntionale offerto dal proprio gestore di rete telefonica. Per informazioni rivolgersi al proprio gestore di rete telefonica.

A condizione che il collegamento telefonico disponga di questa funzione, l'apparecchio visualizza il numero telefonico del chiamante non appena il telefono squilla. Nel caso in cui il chiamante abbia soppresso la trasmissione del proprio numero di chiamata, appare un'apposita indicazione. Se il numero di chiamata non è visualizzabile, questo non sarà memorizzato nell'elenco chiamate.

## Segreteria integrata nella rete telefonica

Sono numerosi i gestori di rete telefonica che offrono come servizio aggiuntionale una segreteria telefonica integrata nella stessa rete. Se il gestore di rete telefonica mette a disposizione una segreteria telefonica all'interno della propria rete, un simbolo informa sulla presenza di nuovi messaggi (VMWI<sup>2</sup>). Questa funzione è disponibile solo nel caso di abilitazione al servizio da parte del gestore di rete telefonica. Per maggiori dettagli rivolgersi al proprio gestore di rete telefonica.

<sup>1</sup> **CLIP**: Calling Line Identification Presentation = Visualizzazione del numero telefonico del chiamante.

<sup>2</sup> **VMWI**: Visual Message Waiting Indication = Segnalazione ottica di nuovi messaggi.

## 9 Specifiche tecniche

Caratteristica	Valore
Standard	<b>DECT<sup>1</sup>-GAP<sup>2</sup></b>
Alimentazione elettrica (stazione base)	Ingresso: 100-240 V, 50-60 Hz Uscita: 6 V, 500 mA
Portata	Esterno: ca. 300 m Interno: ca. 50 m
Autonomia di stand-by	fino a 110 ore
Max. durata di conversazione	fino a 11 ore
Max. volume del ricevitore	30 dB
Batterie ricaricabili	2 x 1.2 V 500 mAh NiMH, tipo: AAA
Procedura di selezione	Selezione a toni (MFV) Selezione a impulsi (IWW)
Tempo flash	breve, medio, lungo
Numero di squilli	12 (polifonici)
Max. numero di voci in rubrica	50
Max. numero di voci nell'elenco chiamate	40
Max. numero di voci per ripetizione di chiamata	5
Lingue di menu	Tedesco, francese, italiano, inglese, spagnolo, portoghese, olandese, polacco, turco

### Dichiarazione di conformità

Questo apparecchio risponde a quanto disposto dalla Direttiva UE

1999/5/CE concernente le apparecchiature radio, le apparecchiature terminali di telecomunicazioni e il reciproco riconoscimento della loro conformità. La conformità con la direttiva indicata è confermata dal marchio CE applicato sull'apparecchio.



### Linea di assistenza

In presenza di problemi con il telefono, seguire le indicazioni riportate qui di seguito. In caso di problemi tecnici è possibile rivolgersi alla linea di assistenza chiamando al numero 0900 00 1675 valido per la Svizzera (spese da rete Swisscom alla data di stampa: 2.60 CHF/minuto). In caso di reclami entro il periodo di garanzia, rivolgersi al rivenditore autorizzato. Il periodo di garanzia ricopre 2 anni.

<sup>1</sup> **DECT**: Digital Enhanced Cordless Telecommunication = Standard per telefoni senza cavo

<sup>2</sup> **GAP**: Generic Access Profile = Standard per l'interazione di unità portatili e stazioni base di altri costruttori.

# Problemi

## 10 Problemi

Domande	Risposte
Non è possibile condurre una chiamata telefonica	<ul style="list-style-type: none"><li>- Il telefono o la stazione base non è collegato/a correttamente oppure si è in presenza di interferenze. Utilizzare esclusivamente il cavo di collegamento telefonico fornito.</li><li>- L'alimentatore di rete non è inserito oppure si è in presenza di una caduta di tensione totale.</li><li>- Provare con un altro telefono se l'allacciamento telefonico in questione è funzionante.</li><li>- Errata ubicazione del telefono (della stazione base).</li><li>- Le batterie ricaricabili sono scariche o difettose.</li><li>- La distanza dalla stazione base è troppo grande.</li><li>- Procedura di selezione non impostata correttamente ☞ pagina 84.</li><li>- Con più unità portatili registrate: chiamata in corso su un'altra unità portatile.</li><li>- Con chiamata interna in corso: l'unità portatile chiamata è fuori della portata della stazione base.</li><li>- Il blocco tastiera è attivato.</li><li>- L'unità portatile non è inserita.</li></ul>
Non è possibile instaurare un collegamento con il telefono (la stazione base)	<ul style="list-style-type: none"><li>- Verificare se al momento della registrazione del telefono (della stazione base) è stato inserito il codice PIN corretto ☞ pagina 84.</li></ul>
Collegamento disturbato, interrotto	<ul style="list-style-type: none"><li>- La distanza dalla stazione base è troppo grande.</li><li>- Errata ubicazione del telefono (della stazione base).</li></ul>
Durante la telefonata si avvertono segnali acustici	<ul style="list-style-type: none"><li>- La distanza dalla stazione base è troppo grande.</li><li>- Le batterie sono quasi scariche.</li></ul>
Il sistema non reagisce più	<ul style="list-style-type: none"><li>- Ripristinare la configurazione iniziale per tutte le funzioni ☞ pagina 84.</li><li>- Estrarre brevemente l'alimentatore di rete dalla presa di corrente.</li></ul>
Le batterie si scaricano piuttosto subito	<ul style="list-style-type: none"><li>- Le batterie sono scariche o difettose.</li><li>- Riporre l'unità portatile correttamente nella stazione base/stazione di carica. Pulire le superfici di contatto su unità portatile e stazione base stazione di carica con un panno morbido e asciutto.</li><li>- Posizionare l'unità portatile per 8 ore nella stazione base/stazione di carica.</li></ul>
Le batterie non si lasciano più ricaricare	<ul style="list-style-type: none"><li>- Le batterie sono difettose.</li></ul>
La visualizzazione del numero di chiamata (CLIP) non funziona	<ul style="list-style-type: none"><li>- La visualizzazione del numero di chiamata è un servizio aggiuntivo offerto dal proprio gestore di rete telefonica. Per maggiori dettagli rivolgersi al proprio gestore di rete telefonica.</li><li>- Il chiamante ha disattivato la trasmissione del proprio numero di chiamata.</li></ul>

## 11 Consigli per la cura/Garanzia

### Consigli per la cura

- Pulire le superfici degli apparecchi con un panno morbido e antipelucchi.
- Non utilizzare mai detersivi o solventi.

Al di là di una occasionale pulizia dell'involucro esterno non è necessario compiere alcuna operazione di pulizia.

### Garanzia

Gli apparecchi **SWITEL** sono costruiti e collaudati in osservanza dei processi di produzione più moderni. L'impiego di materiali selezionati e tecnologie altamente sviluppate sono garantiti di una perfetta funzionalità e lunga durata in vita. La garanzia non viene considerata esecutiva qualora la causa del malfunzionamento dell'apparecchio sia riconducibile al gestore della rete telefonica oppure se questa è da attribuirsi ad un impianto telefonico interno interposto. La garanzia non si estende a pile, batterie ricaricabili o pacchi batteria utilizzati all'interno degli apparecchi. Il periodo di garanzia ricopre 24 mesi a partire dalla data di acquisto.

Entro il periodo di garanzia si procederà all'eliminazione gratuita di tutti i guasti dovuti a difetti di materiale o produzione. Il diritto di garanzia cessa in caso di interventi da parte dell'acquirente o di terzi. Danni derivanti da un impiego o esercizio non conforme agli usi previsti, a naturale usura, a errato montaggio o errata conservazione, a collegamento o installazione impropri, dovuti a forza maggiore o ad altri influssi esterni non sono coperti da garanzia. In qualità di produttore ci riserviamo il diritto, in caso di reclami, di riparare o sostituire le parti difettose o di rimpiazzare l'apparecchio. Parti o apparecchi sostituiti passano di nostra proprietà. Sono esclusi diritti di risarcimento per danni qualora non siano dovuti a intenzione o colpa grave del costruttore.

Nel caso in cui il presente apparecchio dovesse ciò nonostante presentare un difetto durante il periodo di garanzia, si prega di rivolgersi esclusivamente al negozio di rivendita dell'apparecchio **SWITEL** assieme al relativo scontrino di acquisto. In base alle presenti disposizioni, tutti i diritti di garanzia dovranno essere fatti valere esclusivamente nei confronti del rivenditore autorizzato. Decorso il termine di due anni dalla data di acquisto e consegna dei nostri prodotti non sarà più possibile fare valere alcun diritto di garanzia.

## 12 Indice alfabetico

### A

- Accettare una chiamata esterna con telefonata interna in corso, 87
- Alimentatore di rete, 72
- Alimentazione elettrica, 99
- Ampliare il sistema telefonico, 96
- Annullare la registrazione, 96
- Annullare la registrazione di un'unità portatile, 96
- Apparecchiature mediche, 73
- Autonomia di stand-by, 99

### B

- Batterie, 99
- Batterie ricaricabili, 73
- Blocco dei tasti, 85, 94
- Blocco di chiamata, 95

### C

- Caduta di tensione, 72
- Cancellare l'elenco di ripetizione di chiamata, 91
- Cancellare numeri dall'elenco chiamate, 92
- Cancellare singoli numeri di chiamata, 92
- Cancellare tutte le voci, 90
- Cancellare tutti i numeri di chiamata, 92
- Cancellare un numero dall'elenco di ripetizione di chiamata, 91
- Cancellare una voce, 90
- Cancellare voci in rubrica, 90
- Caricare le batterie, 75
- Cercare, 94
- Chiamata d'emergenza, 95
- Chiamata in attesa, 87
- Chiamate in conferenza, 87
- Chiamate interne, 86
- Chiamate perse, 92
- CLIP, 95, 98
- Codice di accesso, 97
- Collegare la stazione base, 74
- Compatibilità con apparecchi acustici, 73
- Compiere chiamate interne, 86
- Compiere telefonate, 85
- Concludere la chiamata, 85
- Consigli per la cura, 101
- Contenuto della confezione, 74
- Contrasto di display, 93
- Creare, 80
- Creare voci di rubrica, 89

## D

DECT, 99  
Dichiarazione di conformità, 99  
Disattivare e attivare lo squillo di chiamata, 88  
Disattivare la sveglia anzitempo, 95  
Disinserire il telefono, 85  
Display, 77  
Durata di conversazione, 88, 99

## E

Elementi di comando, 76  
Elenco chiamate, 92  
Elenco di ripetizione di chiamata, 91  
Equalizzatore, 93

## F

Formato di ora e data, 93  
Funzionamento, 85  
Funzione baby controllo, 95  
Funzione vivavoce, 88  
Funzioni speciali, 95

## G

GAP, 99  
Garanzia, 101

## I

Impianti telefonici interni, 75, 97  
Impiego conforme agli usi previsti, 72  
Impostare il volume del ricevitore, 88  
Impostare il volume dello squillo di chiamata, 88  
Impostare l'ora, 75  
Impostare la data, 75  
Impostare la lingua di display, 75  
Impostare la sveglia, 95  
Impostare lo squillo di chiamata, 93  
Impostazione di toni e indicazioni, 93  
Indicazioni di sicurezza, 72  
Inoltrare la chiamata, 87  
Inoltro di chiamata, 87  
Inserimento di testo, 89  
Inserire il telefono, 85  
Inserire le batterie, 75  
Inserire nomi, 89

## L

Linea di assistenza, 99  
Lingue di menu, 99  
Luogo di installazione, 72

## M

Memorizzare, 92  
Menu principale, 81  
Messa in funzione, 74  
Mettere in funzione l'unità portatile, 74  
Mobilteil, 76  
Modalità di stand-by, 79  
Modalità ECO, 75  
Modi di rappresentazione, 79  
Modificare il PIN , 94  
Modificare voci in rubrica, 90

# Indice alfabetico

---

## N

- Navigazione nel menu, 79
- Nome del portatile, 93
- Numero di accesso alla rete esterna, 97
- Numero di voci in rubrica, 99
- Numero di voci nell'elenco chiamate, 99
- Numero di voci per ripetizione di chiamata, 99

## P

- Paging, 94
- Pausa di selezione, 97
- Più stazioni base, 96
- Più unità portatili, 96
- Portata, 99
- Prefisso, 94
- Problemi, 100
- Procedura di selezione, 95, 99
- Programmare i tasti di selezione diretta, 91
- Pulizia, 101

## R

- Registrazione, 96
- Registrazione un'unità portatile, 96
- Reset, 94
- Ricevere una chiamata, 85
- Ricezione automatica di chiamate, 94
- Richiamare chiamate ricevute, 86, 93
- Richiamata, 86
- Riduzione delle radiazioni, 75
- Ripetizione di chiamata, 86
- Riscontro, 87
- Rubrica telefonica, 86, 89

## S

- Salvare, 80
- Salvare in rubrica un numero dall'elenco di ripetizione di chiamata, 91
- Segreteria integrata nella rete telefonica, 98
- Selezionare, 86
- Selezionare un numero dall'elenco di ripetizione di chiamata, 92
- Selezione diretta, 86
- Servizi aggiuntivi, 97
- Silenziamento, 89
- Silenziamento del microfono, 89
- Simboli, 77
- Simboli di display, 77
- Smaltimento, 73
- Squilli, 99
- Stato di carica delle batterie, 75
- Stazione base, 78
- Struttura di menu, 81
- Suono dei tasti, 93
- Suono di avviso del livello di carica delle batterie, 93
- Suono di avviso di portata, 93
- Sveglia, 95

## T

- Tasto R, 97
- Telefonare, 85
- Tempo flash, 99
- Trasferire internamente chiamate esterne, 87

## V

- Verificare la memoria di rubrica, 91
- Visualizzare il numero di chiamata, 92, 98
- Visualizzare il numero di chiamata (CLIP), 95
- VMWI, 98
- Voci di rubrica, 80
- Volume del ricevitore, 99



1	Safety Information . . . . .	106
2	Starting Up . . . . .	108
3	Operating Elements . . . . .	110
4	Preliminary Information . . . . .	113
5	Menu Structure . . . . .	115
6	Operation . . . . .	119
7	Extending the Telephone System . . . . .	130
8	PBX / Supplementary Services . . . . .	131
9	Technical Properties . . . . .	133
10	In Case of Problems . . . . .	134
11	Maintenance / Guarantee . . . . .	135
12	Index . . . . .	136

# Safety Information

---

## 1 Safety Information

Please read this operating instruction manual thoroughly.

### Intended use

The telephone set, comprised of handset(s) and base station, is suitable for telephoning within a public telephone network system. Any other use is considered unintended use. Unauthorised modification or reconstruction is not permitted. Under no circumstances open the device or complete any repair work yourself.

### Power failure

The telephone cannot be used to make calls in the event of a power failure. Always keep a wired telephone which operates without an external power supply available in case of emergency situations.

### Installation location

The installation location is a decisive factor to ensure trouble-free operation.

Prevent excessive exposure to smoke, dust, vibration, chemicals, moisture, heat and direct sunlight. Do not use the telephone in potentially explosive areas.

Do not place the telephone (base station) in the direct vicinity of other electronic devices such as TV sets, microwave ovens, refrigerators etc., because they can mutually affect each other. Do not place the telephone (base station) near another phone. Ensure that no large metallic objects, such as a refrigerator or a mirror, are located between the base station and handset. Walls, too, can impair the connection between the base station and handset.

Position the telephone (base station) near a suitable power socket and telephone line socket. Pay attention that the cable cannot be tripped over!



**Attention:** The cables must not be extended!

Place the telephone (base station) on a level, non-slip surface. Normally, the device footpads do not leave any marks on the surface where it is located. However, due to the diverse types of paints and surfaces which come into question, it cannot be fully ruled out that the footpads will leave marks on the surface on which it is located.

The higher the base station is located (even inside a building), the further its range.

### Power adapter plug



**Attention:** Only use the power adapter plug supplied because other adapter plugs could damage the telephone. Ensure access to the power adapter plug is not obstructed by furniture or such.

## Rechargeable batteries



**Attention:** Never throw batteries into a fire. Only use batteries of the same type. Pay attention to correct polarity. Incorrect polarity of the battery represents a risk of explosion during charging.



**Attention:** Only use the rechargeable batteries prescribed. Never use standard batteries. Risk of explosion!

## Medical equipment



**Attention:** Never use the telephone in the vicinity of medical equipment. Effects on such equipment cannot be fully ruled out.

## Hearing aid compatibility

The telephone is compatible with most popular hearing aids on the market. However, it cannot be guaranteed that all hearing aids will work perfectly.

DECT<sup>1</sup> telephones can cause an unpleasant humming sound in hearing aids.

## Disposal

In order to dispose of your device, take it to a collection point provided by your local public waste authorities (e.g. recycling centre). According to laws on the disposal of electronic and electrical devices, owners are obliged to dispose of old **electronic and electrical devices** in a separate waste container. The adjacent symbol indicates that the device must not be disposed of in normal domestic waste!



### Risks to health and the environment from batteries!

Never open, damage or swallow batteries or allow them to pollute the environment. They could contain toxic and ecologically harmful heavy metals. You are legally obliged to dispose of power packs and batteries at the point of sale or in the corresponding containers provided at collection points by local public waste authorities. Disposal is free of charge. The adjacent symbols indicate that the batteries must not be disposed of in domestic waste and that they must be disposed of at an authorised collection point.



**Packaging materials** must be disposed of according to local regulations.

<sup>1</sup> DECT: Digital Enhanced Cordless Telecommunication = Standard for cordless telephones.

# Starting Up

## 2 Starting Up

### Safety information



**Attention:** It is essential to read the Safety Information in Chapter 1 before starting up.

### Checking the package contents

The package contains:

Content	Model DC 58X			
	DC 581	DC 582 <sup>1</sup>	DC 583 <sup>1</sup>	DC 584 <sup>1</sup>
Base station with power adapter plug	1	1	1	1
Charging station with power adapter plug	-	1	2	3
Handset	1	2	3	4
Telephone connection cable	1	1	1	1
Batteries (AAA 1.2 V NiMH)	2	4	6	8
Operating manual	1	1	1	1

### Putting the handset into operation

#### Connecting the base station

Connect the base station as illustrated in the diagram. For safety reasons, only use the power adapter plug supplied.

It is essential to observe the information regarding the installation location; Page 106.

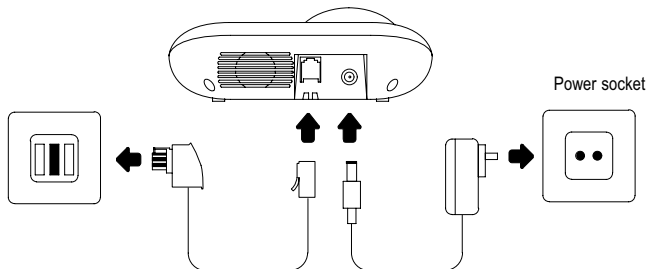

With regard to the base station, only use the power adapter plug supplied labelled with the output data 100-240 Vac 6 Vdc 500 mA.

<sup>1</sup> Visit [www.switel.com](http://www.switel.com) to find out whether the telephone/telephone set is already available.

## Inserting the batteries

The battery compartment is located on the rear side of the handset. Open the battery compartment and insert the two rechargeable batteries of the type AAA NiMH, 1.2 V 500 mAh. Pay attention to the correct polarity. Close the battery compartment.

## Charging the batteries



Before the handset is used for the first time, insert it in the base/charging station for **at least 8 hours**.

When the handset is inserted in the base/charging station properly, you will hear a confirmation signal. The handset warms up during the charging process. This is normal and does not represent a risk. Do not charge the handset with charging units from other manufacturers. The current **battery charge status** is indicated in the display:



Full



Empty

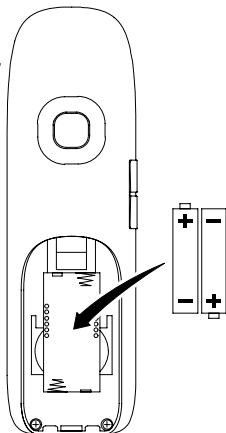

## Setting the display language

Select the language required. Refer to Page 117 for the sequence of menu option selections.

> HS setting > Language >...

There are 9 languages available for selection: German, French, Italian, English, Spanish, Portuguese, Dutch, Polish and Turkish.

## Setting the date and time

The date and time are set using the menu; Page 116.

Confirm each entry for year, month, day, hour and minute individually by pressing the button. Pay attention to the time format set; Page 116. If the 12-hour format is set, use the / buttons to select whether the time set is before midday (A) or after midday (P).

## Private branch exchanges

The information on Page 131 explains how to install your telephone (base station) in a private branch exchange.

## Low-radiation operation (ECO mode)

The level of radiation is considerably lower than that of standard DECT cordless telephones in Standby mode when the handset is in the base station. In talk mode, radiation is reduced according to the distance between the handset and base station.















# Operating Elements

## 3 Operating Elements

The telephone buttons in this operating manual are subsequently depicted with a uniform contour. Therefore, slight deviations in the appearance of the symbols on the telephone keys compared to those depicted here are possible.





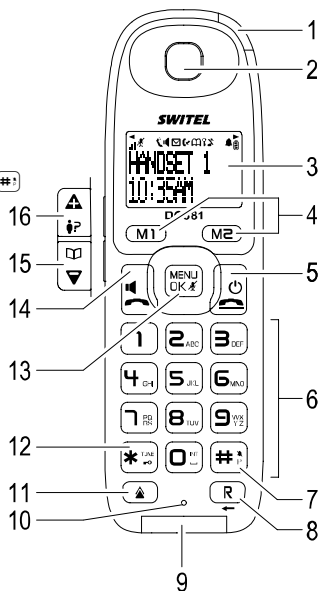





















### Handset

- 1 Call LED (visual call alert)
- 2 Earpiece
- 3 LC display
- 4 One-touch dialling buttons 
- 5 On-hook button / Off button 
- 6 Keypad 
- 7 # button / Ringing tone off / Dialling pause 
- 8 R-signal button / Back 
- 9 Visual call indicator 
- 10 Microphone
- 11 Redialling 
- 12 Star button 
- 13 Menu / OK / Muting button 
- 14 Call button / Handsfree mode 
- 15 Arrow down button / Phone book 
- 16 Arrow up button / Call list 



# Operating Elements

## Icons and texts in the handset display

Icon	Description
	Displays the current battery charge capacity. Off: The batteries must be charged. Run-through segments: The batteries are being charged;  Page 109.
	Connection to the base station. The more bars displayed the better the connection (max. 3 bars).
	Flashing: A call has been received;  Page 119. On: A call is currently in progress;  Page 119.
	Missed calls. New calls have been registered in the call list;  Page 126.
	You have opened the phone book;  Page 123.
	The entry or display has more characters to the right;  Page 123.
	The entry or display has more characters to the left;  Page 123.
	The ringing tone has been switched off;  Page 122.
	The microphone is deactivated (muted);  Page 123.
	The handsfree facility is activated;  Page 122.
	The key lock function is activated;  Page 119.
	The alarm clock is switched on;  Page 129.
	Answering machine provided in the telephone network. <b>VMWI</b> - Supplementary service offered by telephone network providers;  Page 132.

# Operating Elements

---

## Base station

- 1 Charging contacts
- 2 Paging button 
- 3 Call LED (visual call alert)

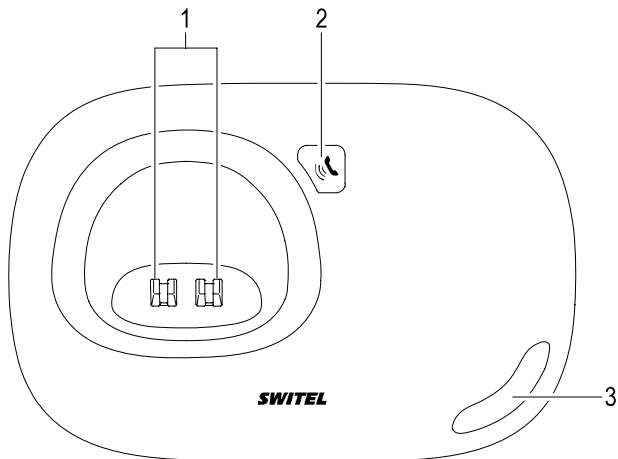













## 4 Preliminary Information

This chapter provides basic information on using the operating instruction manual.

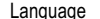
### Description of operating sequences in the manual

Display	Description
	Displays the contour of keys
	Press the key depicted briefly
	Press any button briefly
2 sec. 	Press the button depicted for 2 seconds
	Enter digits or letters
	Handset rings
	Base station rings
	Remove handset from base station
	Replace handset in base station
	Depicts text in the display
	Depicts icons in the display

### Standby mode







All the descriptions in this manual assume that the telephone (base station) and handset are in Standby mode. The telephone (base station) and handset are in Standby mode when no call is in progress and no menu is open.

### Navigating in the menu

All the functions can be accessed via the various menus. Refer to the Menu Structure  Page 115 for information on how to access each respective function.







Every process is automatically cancelled if there is no input within 20 seconds.

	Open the main menu
	Select the required submenu
	Open the submenu
	Select the required function
	Open the function
	Select the required setting

<sup>1</sup> Letters are also imprinted on the digit keys. Letters, digits and special characters are entered by pressing the relevant key the respective number of times.

# Preliminary Information

















	Use the digit keys to enter numbers or letters
	Confirm the input
	Return to previous menu level
	Cancel all programming and saving processes and return the handset to Standby mode



Many entries which are concluded by pressing the  button are confirmed by an accompanying acoustic signal.

## Creating phone book entries - example





The way in which to navigate through the menus and select settings is explained by means of the example **Creating phone book entries** (handset). Proceed as in this example for all the settings.

	Open the main menu
 /  Phonebook 	Open the phone book
 Add 	Select the submenu and confirm it
Enter name  	Enter the name (max. 12 characters) and confirm it
Number  	Enter phone number 1 (mobile number) (max. 24 digits) and confirm it
Number  	Enter phone number 2 (landline number) (max. 24 digits) and confirm it
VIP melody  /  	Assign a ringing tone
	Return to Standby mode



Two phone numbers can be stored per name or entry. The first memory location is preceded by a mobile phone icon, the second memory location a house icon. Therefore, we recommend only programming mobile phone numbers for the first memory location and only landline numbers for the second memory location.

## 5 Menu Structure



Press the  button to open the main menu. Then use the  /  buttons to select an entry and confirm it by pressing the  button. Further information on the menu and operation:  Chapter 4.

### Intercom



Handset 01 - 06 (only when the corresponding number of handsets is registered)

### Phonebook

#### Add

Enter name	 <sup>1</sup>
Number	
Number	
VIP melody	01 / 02 / ... / Off

#### Edit

Enter name	 <sup>1</sup>
Number	
Number	
VIP melody	01 / 02 / ... / Off

#### Delete

Delete all

Copy to

M1

M2

Usage

<sup>1</sup> Letters are also imprinted on the digit keys. Letters, digits and special characters are entered by pressing the relevant key the respective number of times.

# Menu Structure

---

## Clock/Alarm

Set alarm

Once

Off

On

Enter time 

Daily

Off

On

Enter time 

Date format

DD/MM

MM/DD

Time format



24-hour

12-hour

Set time 

# Menu Structure

## HS setting

HS sound	
Ring volume	05 / ... / 01 / Off
Ext. ring	12 / ... / 01
Int. ring	12 / ... / 01
Key tone	Off / Tone / Ring tone
Low batt	On/Off
Out-of-range	On/Off
Equalizer	
Natural	
Bass	
Treble	
LCD contrast	06 / ... / 01
Handset Name 	
Auto Answer	On/Off
Baby call	
Off	
On	Enter Number 
Auto keylock	On/Off
Language	(9 language)

# Menu Structure

## Base setting

Clear VMWI

Register

Base	PIN? <sup>2</sup>
------	-------------------

Base	PIN? <sup>2</sup>
------	-------------------

Base	PIN? <sup>2</sup>
------	-------------------

Base	PIN? <sup>2</sup>
------	-------------------

Select base

Base
------

Base
------

Base
------

Base
------

Auto
------

Advance

Dial mode	Tone/Pulse
-----------	------------

Recall time	Short/Medium/Long
-------------	-------------------

Prefix	
--------	---

Call barring	04 / ... / 01  Enter Number 
--------------	---

SOS number	04 / ... / 01  Enter Number 
------------	---

Deregister	Handset
------------	---------

Change pin	PIN? 
------------	--

Reset	Confirm?
-------	----------

<sup>2</sup> The default PIN code is "0000".

## 6 Operation

### Switching the telephone on and off

No calls can be received when the telephone is switched off.

No battery power is used when the telephone is switched off.



No emergency calls can be made when the telephone is switched off. The telephone must be switched on beforehand, which can take a little time.



Switch the phone on (activate Standby mode)



Switch the phone off

### Key lock

The key lock feature prevents functions assigned to buttons being activated accidentally.



Activate the key lock function



Incoming calls can still be taken in the normal way even when the key lock function is activated.



Deactivate the key lock function

When the key lock is activated, the icon appears in the display.

The phone can be set-up so that the key lock is automatically activated after 90 seconds if no operation is carried out; Page 128.

### Telephoning

#### Taking a call

In addition to the ringing tone, the visual call indicator lights up when a call is received.



Take the call



Do not hold the phone too close to your ear when it rings as doing so could cause hearing damage!

If you have activated the automatic answering function, the call is taken when the handset is removed from the base station; Page 128.

#### Ending a call



End the call

You can also end the call by replacing the handset in the base station.

#### Making a call



Enter the phone number (max. 24 digits)



Delete the last digit if it is wrong



Dial the phone number





It is also possible to press the button first to obtain the dialling tone for an outside line. The digits then entered for the phone number (max. 48 digits) are dialled immediately. It is not possible to correct wrong digits individually using this dialling procedure.

# Operation

## Redialling



The handset stores the last 5 phone numbers dialled together with the date and time of the call. If you want to dial a number again, e.g. because the connection was engaged or the call was not taken, use the redialling function:

	Open the redialling list and select the entry required
	Dial the number

The phone number stored is automatically dialled and a connection established.



## Calling back missed calls

Your handset stores 40 phone numbers in a call list.

	Open the call list and select an entry
	Dial the number

## Dialling numbers from the phone book

Phone numbers must have been stored in the phone book for this function;  Page 123.

	Open the phone book and select an entry
	Dial the number



In order to access phone book entries more quickly, open the phone book and enter the first letters of the entry required. The first entry beginning with these letters appears in the displayed and is marked.

## Dialling phone numbers using the one-touch dialling buttons

Phone numbers must have been assigned to the one-touch dialling buttons;  Page 125.





	Dial the number
---	-----------------

The phone number stored is automatically dialled.

## Internal calls

There must be two or more handsets (HS1, HS2, ...) registered on your phone (your base station) in order to make internal calls free of charge.

## Making internal calls

	<b>Intercom</b> , 	Initiate an internal call
		Dial the internal call number of the required handset
HS2: 		Internal call is taken on the other handset
HS1 / HS2: 		End the internal call



If the handset you have dialled for an internal call is involved in an external call, you will hear an acoustic signal and Line busy appears in the display.



## Taking external calls when an internal call is in progress



When an external call is received while you are involved in an internal call, a message appears in the display.



Take the external call

With regard to the handset which did not take the external call, press the  button to end the internal call.

## Transferring external calls internally

 /  /  , **Intercom** , 

While the external call is in progress

 /  , 

Dial the internal call number of the handset required

HS2: 

Internal call is taken on the other handset

HS1: 

Forward the call

or

3 sec.  **Intercom**

While the external call is in progress

 /  , 

Dial the internal call number of the handset required

HS2: 

Internal call is taken on the other handset

HS1: 

Forward the call

## Holding a call / brokering

 /  /  , **Intercom** , 



While the external call is in progress

 /  , 

Dial the internal call number of the handset required

HS2: 

Internal call is taken on the other handset

 /  /  , **Switching** , 

Switch to the other caller

## Making conference calls

An external call can be transferred to another internal handset for a conference call.

 /  /  , **Intercom** , 

While the external call is in progress

 /  , 

Dial the internal call number of the handset required

HS2: 

Internal call is taken on the other handset

HS1: 2 sec.  , **Conference**







Start the conference call

HS1 / HS2: 

End the conference

# Operation

or

3 sec.  Intercom	While the external call is in progress
 /  ,  MENU OK #	Dial the internal call number of the handset required
HS1: 2 sec.  , Conference	Start the conference call
HS1 / HS2: 	End the conference

## Displaying the duration of a call

A few seconds after a call has begun, the current duration of the call appears in the display in minutes and seconds.

## Setting the receiver volume













The volume at the receiver can be adjusted to one of 5 levels during a call.

 / 	Raise/Lower the receiver volume
---	---------------------------------

## Ringing volume

### Adjusting the ringing volume

You can change the volume of the ringing tone. There are 5 volumes available for selection as well as the option to switch it off.

 MENU OK #	Open the menu
 /  HS setting  MENU OK #	Select HS setting
 /  HS sound  MENU OK #	Select HS sound
 /  Ring volume  MENU OK #	Select Ring volume
 / 	Raise/Lower the ringing tone volume
 MENU OK #	Save the settings

## Switching the ringing tone on and off



3 sec. 	Switch the ringing tone off
3 sec. 	Switch the ringing tone on

You can also deactivate the ringing tone using the menu.

When the ringing tone is switched off, the  icon appears in the display.

## Handsfree

This function is used to listen to the caller via the loudspeaker.

	During a call: Switch the handsfree function on
	During a call: Switch the handsfree function off

When the handsfree function is activated, the  icon appears in the display.

## Muting function

You can switch the microphone in the handset off during a call so that the caller cannot hear you, e.g. if you need to consult someone else nearby, and then switch it on again.

2 sec. During a call: Switch the microphone off (muting)

2 sec. During a call: Switch the microphone on

When the microphone is muted, the icon appears in the display.

## Phone book

You can store up to 50 contacts in the phone book, each with up to 2 phone numbers.

- Always enter the area access code with the phone numbers so that incoming local calls can also be assigned to a phone book entry.
- When the memory capacity is used up, the message **Mem Full** appears when an attempt is made to store another number. To create space, an existing entry must first be deleted.
- The phone book entries are arranged alphabetically.

When the phone book is open, the icon appears in the display.

## Entering names

Letters are also imprinted on the digit keys. Letters, digits and special characters are entered by pressing the relevant key the respective number of times.

0 Enter a space

1 Enter a special character

Delete

/ Move the cursor



To enter the same letter twice, press the key to enter the letter. Wait until the cursor skips one position forwards. Enter the letter again.

## Creating phone book entries

Also refer to Page 114

Open the phone book

Add Select the submenu and confirm it

Enter the name (max. 12 characters) and confirm it

Enter phone number 1 (mobile number) (max. 24 digits) and confirm it

Enter phone number 2 (landline number) (max. 24 digits) and confirm it

/ Assign a ringing tone

If the entries are longer than can be shown in the display, the and icons appear in the display. They indicate that the entry continues to the left or right of the display, respectively.

# Operation

When the memory capacity is used up, the message **Mem Full** appears when an attempt is made to store another number. To create space, an existing entry must first be deleted.

If a name already exists under which you want to store a new entry, the message

**Double name** also appears in the display during the process.

## Editing phone book entries

	Open the phone book
/  ,	Select an entry and confirm it
/  , <b>Edit</b>	Select the submenu and confirm it
<b>Enter name</b>	Edit the name (max. 12 characters) and confirm it
<b>Number</b>	Edit phone number 1 (mobile number) (max. 24 digits) and confirm it
<b>Number</b>	Edit phone number 2 (landline number) (max. 24 digits) and confirm it
<b>VIP melody</b> ,  /  ,	Assign a ringing tone

## Deleting phone book entries

### Deleting an entry

	Open the phone book
/  ,	Select an entry and confirm it
/  , <b>Delete</b>	Select the submenu and confirm it



In order to access phone book entries more quickly, open the phone book and enter the first letters of the entry required. The first entry beginning with these letters appears in the displayed and is marked.

### Deleting all entries

	Open the phone book
	Open the menu
/  , <b>Delete all</b>	Select the submenu and confirm it
<b>Confirm?</b> , <b>Empty</b>	Confirm the deleting process

or

<b>Confirm?</b> ,  or	Cancel the deleting process
-----------------------	-----------------------------

## Checking the phone book capacity

You can display how many of the 50 memory locations are already assigned.

	Open the phone book
	Open the menu
/  , <b>Usage</b>	Select the submenu and confirm it

## Programming one-touch dialling buttons

You have the possibility of assigning two numbers already stored in the phone book to the buttons **M1** and **M2** respectively, so that they are dialled immediately on pressing the buttons (one-touch dialling).

	Open the phone book
/  ,	Select an entry and confirm it
/  , <b>Copy to</b>	Select the submenu and confirm it
<b>M1</b> ,  /  ,	Select the one-touch dialling button and confirm it
	Confirm the phone number displayed

Dialling phone number via one-touch dialling button; Page 120.

## Redialling list

The handset stores the last 5 phone numbers dialled together with the date and time of call.

### Saving a number in the redialling list in the phone book

	Open the redialling list
/  ,	Select an entry and confirm it
/  , <b>Save Number</b>	Select the submenu and confirm it
<b>Enter name</b>	Enter the name (max. 12 characters) and confirm it
<b>Enter Number</b>	Edit the phone number if necessary (max. 24 digits) and confirm it
/  ,	Define whether the number is a mobile phone number or a landline number and confirm it

### Deleting phone numbers from the redialling list

	Open the redialling list
/  ,	Select an entry and confirm it
/  , <b>Delete</b>	Select the submenu and confirm it

### Deleting the entire redialling list

	Open the redialling list
	Open the menu
/  , <b>Delete all</b>	Select the submenu and confirm it
<b>Confirm?</b> , <b>Empty</b>	Confirm the deleting process

# Operation

or

Confirm? , R or Cancel the deleting process

## Dialling phone numbers from the redialling list

Page 120

## Call list

All incoming calls received in your absence are recorded in a call list. The call list can contain up to 40 phone numbers. The time and date of receipt are recorded for each call.

When the call list is open, the icon appears in the display.

The last call received appears at the top of the call list.

If calls have been received in your absence, the visual call indicator flashes and the icon appears in the display. Until the call list is actually opened, the display also indicates how many calls have been received.

## Displaying numbers in the call list

, / Open the call list and select an entry

## Storing a phone number in the call list in the phone book

A phone number in the call list can be stored in the phone book directly.

, / Open the call list and select an entry

Open the menu

/ Save Number , Select the submenu and confirm it

Enter name Enter the name (max. 12 characters) and confirm it

Enter Number Edit the phone number if necessary (max. 24 digits) and confirm it

/ , Define whether the number is a mobile phone number or a landline number and confirm it

## Deleting phone numbers in the call list

### Deleting individual phone numbers

, / Open the call list and select an entry

Open the menu

/ Delete , Select the submenu and confirm it

### Deleting all phone numbers

Open the call list

Open the menu

/ Delete all , Select the submenu and confirm it

Confirm? , Empty Confirm the deleting process

or

Confirm?



or



Cancel the deleting process

## Calling back calls received

☞ Page 120

## Acoustic and visual settings

You can define various settings in order to adapt the telephone to your specific needs:

### Setting the ringing tone

It is recommended to set different ringing tones to distinguish between internal and external calls. There are a total of 12 polyphone ringing tones available.

Setting the ringing tone; ☞ Menu, Page 117

### Key tones

The key tones provide confirmation that a button has actually been pressed. The phone can be set-up so that the same tone is issued regardless of the button pressed (Setting: Tone) or different key tones are produced (Setting: Melody). It is also possible to switch the key tone function off.

Setting the key tones; ☞ Menu, Page 117

### Acoustic warning signal, battery capacity

The acoustic warning signal alerts you to the fact that the battery capacity is low.

Setting the battery capacity acoustic warning signal; (Low batt); ☞ Menu, Page 117

### Acoustic warning signal, range

The acoustic warning signal alerts you to the fact that the handset is out of range of the base station.

Setting the range acoustic warning signal (Out-of-range); ☞ Menu, Page 117

### Equalizer

You can adapt the tone of the loudspeaker to your individual needs. You can leave the tone in its Natural setting or increase the Bass or Treble tone.

Setting the equalizer; ☞ Menu, Page 117

### Display contrast

The contrast of the display (LCD contrast) can be set to one of 6 different levels; ☞ Menu, Page 117

### Handset name

You can assign individual names to each handset (Handset Name); ☞ Menu, Page 117

### Time and date format

You can define the format and the sequence in which the time and date should be displayed;

☞ Menu, Page 116

# Operation

---

## Other settings

### Automatic answering

If this function is activated, an incoming call is taken when the handset is removed from the base/charging station. The automatic answering function is activated and deactivated using the menu.



Activating automatic answering;  Men, Page 117

### Key lock

If this setting is activated, the key lock function is automatically enabled when no button has been pressed for a period of 90 seconds. When the key lock is activated, the  icon appears in the display.

Activating the key lock;  Menu, Page 117

### Prefix number

You can store a prefix number (Prefix). By pressing and holding the  button before or after entering a phone number, the prefix number is set to precede the phone number. Press the  button to dial this number.

Changing the prefix;  Menu, Page 118

### Changing the PIN

The PIN code is required in order to register handsets. The PIN set at the factory is "0000".

Changing the PIN;  Menu, Page 118

### Reset

This function enables you to reset the phone to its default settings defined at the factory.

Reset;  Menu, Page 118

## Searching for the handset (Paging)

If you have mislaid your handset, you can sound a paging tone to find it.



Conditions: The handset is switched on and is within range of the base station. The batteries are not empty.



Start the paging tone



---

Stop the paging tone



## Special functions

### Alarm clock

The "Alarm clock" function can be used so that you are woken or alerted by the handset at a specific time. When the alarm clock function is activated, the  icon appears in the display. The selected tone is played for 1 minute at the set time. The message **Alarm** appears in the display.

### Setting the alarm clock function

You can define whether the alarm clock function should only be set for a one-off alert (Once) or whether the alarm should alert you every day at the same time (Daily).



Setting the alarm (Set alarm);  Menu, Page 116

### Stopping the alarm prematurely



Stop the alarm

### Baby call

Use this function to store a set a specific phone number (max. 24 digits) that will be dialled automatically when any button (except  and ) is pressed.

If the function is switched on, the **Baby call** message flashes continually in the display.

Activating baby call;  Menu, Page 117

### Call barring

The call barring function prevents handsets dialling phone numbers which begin with digits previously defined and stored. Up to 4 barring numbers with max. 8 digits can be stored.

Activating call barring;  Menu, Page 118

### Emergency call numbers

You can store up to 4 phone numbers which can still be dialled even when the call barring function is activated. Refer to Page 118 for the sequence of menu option selections.

### Dialling mode

The handset can be operated in analogue exchanges (pulse dialling mode) as well in newer digital exchanges (tone dialling mode / DTMF). The dialling mode is controlled via the menu. Refer to Page 118 for the sequence of menu option selections.

### Caller number display (CLIP)



The caller number display (CLIP) and display of date and time are optional services offered by your telephone network provider. Contact them for any further information.

If the CLIP function is available for your telephone system (CLIP = **C**alling **L**ine **I**dentification **P**resentation), the number of the caller appears in the display when a call is received - as long as callers have agreed to transmission of their phone number.



If you do not take a call received, the information remains in the display for approx. 6 seconds before the current time and date reappear.

# Extending the Telephone System

## 7 Extending the Telephone System

The internationally approved **GAP**<sup>1</sup> standard regulates the compatibility of handsets and telephones (base stations) from different manufacturers. As a result, it is possible to integrate SWITEL devices and devices from other manufacturers together in one telephone system. It is possible, however, that some functions are not available.

### Multiple handsets

You can register 6 handsets on your telephone (base station).

### Registering handsets

Handsets are registered using the menu on the telephone (base station). Refer to Page 118 for the sequence of menu option selections.

Approx. 10 sec. 



To initiate the registration process, press the button until the visual call indicator on the phone flashes.

 /  /  , **Base setting** , 



Open the menu

 /  , **Register** , 

Open the menu

 /  , **Base x** , 

Select the base

**PIN?**  , 

Enter the PIN<sup>2</sup> and confirm it

The handset searches for the base station. This process can take up to 2 minutes.

The handset is automatically assigned an internal call number following registration. The internal call number appears in the display.



To register handsets from other manufacturers, please refer to the operating manual supplied with them.

### Deregistering handsets



You can only deregister a handset from a telephone (base station) using another handset registered on the telephone (base station).

Handsets are deregistered using the menu on the telephone (base station). Refer to Page 118 for the sequence of menu option selections.

### Several base stations

You can increase the range of your handset by registering it on several telephones (base stations). The handset can be registered on up to 4 different telephones (base stations) simultaneously. Each telephone (base station) requires its own telephone connection socket. Connections can be used with the same call number or with different ones.



Calls in progress cannot be transferred from one telephone (base station) to another.

<sup>1</sup> **GAP**: **Generic Access Profile** = Standard for the interoperation of handsets and base stations from different manufacturers.

<sup>2</sup> The default PIN code is "0000".

## 8 PBX / Supplementary Services

### R-button and supplementary services

Your telephone supports supplementary services provided by your telephone network provider, such as brokering, call waiting and conference facilities. Press the **(R)** button to use these supplementary services. Please contact your telephone network provider regarding which Recall (Flash) time must be set to use the supplementary services. Also contact your telephone network provider with regard to enabling supplementary services. The Recall time is set using the menu. Refer to Page 118 for the sequence of menu option selections.

### R-button on private branch exchanges

If the telephone is connected to a private branch exchange, functions such as transferring calls and automatic call back can be used via the **(R)** button. Refer to the operating manual provided with your private branch exchange as to which Recall (Flash) time must be set in order to use these functions. The sales outlet where you purchased the exchange can provide information as to whether the telephone will work properly with the exchange. The Recall time is set using the menu. Refer to Page 118 for the sequence of menu option selections.

### Number for an outside line (access code)

When using private branch exchanges, it is necessary to dial an access code to obtain the dialling tone for an outside line. The number for an outside line is often "0" or "9". Dial this number first and wait for the dialling tone. You can then dial the actual phone number.



If one-touch dialling buttons are to be used when the phone is connected to a private branch exchange, please take this into consideration and enter the access code before the actual phone number when programming the one-touch dialling buttons.

It is also possible to program a dialling pause between the number for an outside line and the actual phone number, see Section "Dialling pause".

### Dialling pause

When using private branch exchanges, it is necessary to dial an access code to obtain the dialling tone for an outside line. When using some older private branch exchanges, it takes a little time before the dialling tone becomes audible. In the case of such private branch exchanges, a dialling pause can be inserted after the number for an outside line in order to continue dialling directly without having to wait for the dialling tone. The dialling pause is inserted by pressing and holding the **(\*\*)** button for 3 seconds.

The actual phone number is dialled a certain time after the number for an outside line.



The dialling pause can also be entered for the phone numbers in the phone book.

# PBX / Supplementary Services

---

## Caller number display (CLIP<sup>1</sup>)



The caller number display (CLIP) is a supplementary service offered by your telephone network provider. Contact your network provider for further information.

If this function is available with your telephone line, the number of the caller appears in the display when the phone rings. If the caller has suppressed transmission of their phone number, the corresponding message appears in the display. The phone number is not displayed and, as a result, is not stored in the call list.

## Answering machine in the telephone network

An answering machine in the telephone network is a supplementary service offered by many telephone network providers. If your telephone network provider offers an answering machine in the telephone network for you, an icon in the display informs you of new messages received (**VMWI**<sup>2</sup>). This function can only be used when your telephone network provider actually offers the service. Contact your network provider for further information.

<sup>1</sup> **CLIP**: Calling Line Identification Presentation = Displays the caller's phone number.

<sup>2</sup> **VMWI**: Visual Message Waiting Indication = Visual indicator that new messages have been recorded.

## 9 Technical Properties

Feature	Value
Standard	DECT <sup>1</sup> -GAP <sup>2</sup>
Power supply (base station)	Input: 100-240 V, 50-60 Hz Output: 6 V, 500 mA
Range	Outdoors: Approx. 300 m Indoors: Approx. 50 m
Standby time	Up to 110 h
Max. talk time	Up to 11 h
Max. receiver volume	30 dB
Rechargeable batteries	2 x 1.2 V 500 mAh NiMH, Size: AAA
Dialling mode	Tone dialling mode (DTMF) Pulse dialling mode
Recall (Flash) time	Short, Medium, Long
Number of ringing melodies	12 (polyphone)
Max. number of phone book entries	50
Max. number of call list entries	40
Max. number of redialling list entries	5
Menu languages	German, French, Italian, English, Spanish, Portuguese, Dutch, Polish, Turkish

### Declaration of Conformity

This device fulfils the requirements stipulated in the EU directive:

1999/5/EC directive on radio equipment and telecommunications terminal equipment and the mutual recognition of their conformity. Conformity with the above mentioned directive is confirmed by the CE mark on the device.



### Service hotline

Should problems arise with the telephone, please refer to the following information first. In the case of technical problems, you can contact our hotline service, Tel. 0900 00 1675 within Switzerland (Swisscom fees at time of going to print: CHF 2.60/min). In the case of claims under the terms of guarantee, please contact your sales outlet. There is a 2 year period of guarantee.

<sup>1</sup> DECT: Digital Enhanced Cordless Telecommunication = Standard for cordless telephones.

<sup>2</sup> GAP: Generic Access Profile = Standard for the interoperation of handsets and base stations from different manufacturers.

# In Case of Problems

## 10 In Case of Problems

Problems	Solutions
No telephone calls possible	<ul style="list-style-type: none"><li>- The telephone or base station is not connected properly or is defective. Only use the telephone connection cable supplied.</li><li>- The power adapter plug is not plugged in or there is a complete power failure.</li><li>- Test whether the telephone connection is in order by using another telephone.</li><li>- Telephone (base station) has been positioned in an unfavourable location.</li><li>- The rechargeable batteries are empty or defective.</li><li>- The handset is too far from the base station.</li><li>- The wrong dialling mode is set; ☞ Page 118.</li><li>- If several handsets are registered: A call is in progress on another handset.</li><li>- In the case of internal phone calls: The handset called is out of range of the base station.</li><li>- The key lock is activated.</li><li>- The handset is not switched on.</li></ul>
No connection possible to the telephone (base station)	<ul style="list-style-type: none"><li>- Check that the handset has been registered on the telephone (base station) with the correct PIN code; ☞ Page 118.</li></ul>
Connection is disturbed or cut off	<ul style="list-style-type: none"><li>- The handset is too far from the base station.</li><li>- Telephone (base station) has been positioned in an unfavourable location.</li></ul>
Acoustic signals can be heard during a phone call	<ul style="list-style-type: none"><li>- The handset is too far from the base station.</li><li>- The rechargeable batteries are almost empty.</li></ul>
The system no longer responds	<ul style="list-style-type: none"><li>- Reset all functions to their default settings; ☞ Page 118.</li><li>- Briefly disconnect the power adapter plug from the power socket.</li></ul>
The batteries are empty within a short time	<ul style="list-style-type: none"><li>- The batteries are empty or defective.</li><li>- Place the handset in the base/charging station properly. Clean the contact surfaces on the handset and base/charging station with a soft, dry cloth.</li><li>- Place the handset in the base/ charging station for 8 hours.</li></ul>
The batteries can no longer be charged	<ul style="list-style-type: none"><li>- The batteries are defective.</li></ul>
The caller number display (CLIP) does not function	<ul style="list-style-type: none"><li>- The caller number display (CLIP) is a supplementary service offered by your telephone network provider. Contact your network provider for further information.</li><li>- The caller has suppressed the transmission of their phone number.</li></ul>

## 11 Maintenance / Guarantee

### Maintenance

- Clean the housing surfaces with a soft, fluff-free cloth.
- Do not use any cleaning agents or solvents.

Apart from occasionally cleaning the housing, no other upkeep is necessary.

### Guarantee

SWITEL equipment is produced and tested according to the latest production methods. The implementation of carefully chosen materials and highly developed technologies ensure trouble-free functioning and a long service life. The terms of guarantee do not apply where the cause of equipment malfunction is the fault of the telephone network operator or any interposed private branch extension system. The terms of guarantee do not apply to the batteries or power packs used in the products. The period of guarantee is 24 months from the date of purchase.

All deficiencies related to material or manufacturing errors within the period of guarantee will be redressed free of charge. Rights to claims under the terms of guarantee are annulled following tampering by the purchaser or third parties. Damage caused as the result of improper handling or operation, normal wear and tear, incorrect positioning or storage, improper connection or installation or Acts of God and other external influences are excluded from the terms of guarantee. In the case of complaints, we reserve the right to repair defective parts, replace them or replace the entire device. Replaced parts or devices become our property. Rights to compensation in the case of damage are excluded where there is no evidence of intent or gross negligence by the manufacturer.

If your device does show signs of a defect within the period of guarantee, please contact the sales outlet where you purchased the SWITEL device, producing the purchase receipt as evidence. All claims under the terms of guarantee in accordance with this agreement can only be asserted at the sales outlet. No claims under the terms of guarantee can be asserted after a period of two years from the date of purchase and hand-over of the product.

## 12 Index

### A

- Access code, 131
- Acoustic and visual settings, 127
- Acoustic warning signal, battery capacity, 127
- Acoustic warning signal, range, 127
- Adjusting the ringing volume, 122
- Alarm clock, 129
- Answering machine
  - in the telephone network, 132
- Automatic answering, 128

### B

- Baby call, 129
- Base station, 112
- Batteries, 107, 133
- Battery charge status, 109
- Brokering, 121

### C

- Call barring, 129
- Call list, 126
- Callback , 120
- Caller number display, 126, 132
- Caller number display (CLIP), 129
- Calling back calls received, 120, 127
- Calls missed, 126
- Changing the PIN, 128
- Charging the batteries, 109
- Checking the phone book capacity, 125
- Cleaning, 135
- CLIP, 129, 132
- Conference calls, 121
- Connecting the base station, 108
- Creating, 114
- Creating phone book entries, 123

### D

- Deactivating the microphone, 123
- Declaration of Conformity, 133
- DECT, 133
- Deleting all entries, 124
- Deleting all phone numbers, 126
- Deleting an entry, 124
- Deleting individual phone numbers, 126
- Deleting phone book entries, 124
- Deleting phone numbers
  - from the redialling list, 125
- Deleting phone numbers in the call list , 126
- Deleting the redialling list, 125
- Deregistering, 130
- Deregistering handsets, 130
- Dialling, 120
- Dialling mode, 129, 133
- Dialling pause, 131
- Dialling phone numbers
  - from the redialling list, 126
- Display, 111
- Display contrast, 127
- Display icons, 111
- Disposal, 107
- Duration of call, 133

### E

- ECO mode, 109
- Editing phone book entries, 124
- Emergency calls, 129
- Ending a call, 119
- Entering names, 123
- Entering text, 123
- Equalizer, 127
- Extending the telephone system, 130

### F

- Flash time, 133
- Forwarding calls, 121



## G

- GAP, 133
- Guarantee, 135

## H

- Handset, 110
- Handset name, 127
- Handsfree, 122
- Hearing aid compatibility, 107
- Holding a call, 121

## I

- Icons, 111
- Inserting the batteries, 109
- Installation location, 106
- Intended use, 106
- Internal calls, 120

## K

- Key lock, 119, 128
- Key tones, 127

## L

- Low-radiation, 109

## M

- Main menu, 115
- Maintenance, 135
- Making a call, 119
- Medical equipment, 107
- Menu guidance, 113
- Menu languages, 133
- Menu structure, 115
- Multiple handsets , 130
- Muting function, 123

## N

- No. of call list entries, 133
- No. of phone book entries, 133
- No. of redialling list entries, 133
- Notation, 113

## O

- One-touch dialling, 120
- Operating elements, 110
- Operation, 119

## P

- Package contents, 108
- Paging, 128
- Phone book, 120, 123
- Phone book entries, 114
- Power adapter plug, 106
- Power failure, 106
- Power supply, 133
- Prefix number, 128
- Private branch exchanges, 109, 131
- Problems, 134
- Programming one-touch dialling buttons, 125
- Putting the handset into operation, 108

## R

- R-button, 131
- Range, 133
- Receiver volume, 133
- Redialling, 120
- Redialling list, 125
- Registering, 130
- Registering handsets, 130
- Reset, 128
- Ringing tones, 133

# Index

---

## S

- Safety information, 106
- Saving, 114
- Saving a number in the redialling list in the phone book, 125
- Searching for the handset, 128
- Service hotline, 133
- Setting the alarm clock, 129
- Setting the date, 109
- Setting the display language, 109
- Setting the receiver volume, 122
- Setting the ringing tone, 127
- Setting the time, 109
- Several base stations, 130
- Special functions, 129
- Standby mode, 113
- Standby time, 133
- Starting Up, 108
- Stopping the alarm prematurely, 129
- Storing, 126
- Supplementary services, 131
- Switching the ringing tone on and off , 122
- Switching the telephone off, 119
- Switching the telephone on, 119

## T

- Taking a call, 119
- Taking external calls when an internal call is in progress, 121
- Talk time, 122
- Telephoning, 119
- Time and date format, 127
- Transferring calls, 121
- Transferring external calls internally, 121

## V

- VMWI, 132

---

## Wichtiger Hinweis

Die Basisstation Ihres Telefons ist mit einem energieeffizienten Schaltnetzteil (Input 100~240 V<sub>AC</sub>, Output 6 V<sub>DC</sub>, 500 mA) ausgestattet. Die Nulllast beträgt ca. 0,15 W. Die durchschnittliche Effizienz beträgt 71 %. Die Leistungsaufnahme der Basisstation beträgt max. 0,78 W.

Die mit einem Telefonset gelieferte(n) Ladestation(en) ist/sind mit einem energieeffizienten Schaltnetzteil (Input 100~240 V<sub>AC</sub>, Output 6 V<sub>DC</sub>, 150 mA) ausgestattet. Die Nulllast beträgt ca. 0,17 W. Die durchschnittliche Effizienz beträgt 67 %. Die Leistungsaufnahme der Ladestation beträgt max. 0,22 W.

## Note importante

La base de votre téléphone est équipée d'une alimentation à découpage à efficacité énergétique (entrée 100~240 V<sub>AC</sub>, sortie 6 V<sub>DC</sub>, 500 mA). La puissance nulle est d'env. 0,15 W. L'efficacité moyenne est 71 %. La puissance absorbée de la base est max. 0,78 W.

La (les) station(s) d'accueil fournies avec un kit téléphonique est/sont équipée(s) d'une alimentation à découpage à efficacité énergétique (tension d'entrée 100~240 V<sub>AC</sub>, tension de sortie 6 V<sub>DC</sub>, 150 mA). La puissance nulle est d'env. 0,17 W. L'efficacité moyenne est 67 %. La puissance absorbée de la station d'accueil est max. 0,22 W.

## Avvertimento importante

La stazione base del telefono è dotata di alimentatore (input 100~240 V<sub>AC</sub>, output 6 V<sub>DC</sub>, 500 mA) particolarmente efficiente in termini di consumo energetico. La potenza a vuoto corrisponde a ca. 0,15 W. L'efficienza media è 71 %. L'assorbimento di corrente della stazione base corrisponde a max. 0,78 W.

La(e) stazione(i) di carica fornita(e) con il set telefonico è/sono dotata(e) di alimentatore (input 100~240 V<sub>AC</sub>, output 6 V<sub>DC</sub>, 150 mA) particolarmente efficiente in termini di consumo energetico. La potenza a vuoto corrisponde a ca. 0,17 W. L'efficienza media è 67 %. L'assorbimento di corrente della stazione di carica corrisponde a max. 0,22 W.

## Important note

The telephone base station is equipped with an energy-efficient switching power supply (input 100~240 V<sub>AC</sub>, output 6 V<sub>DC</sub>, 500 mA). The zero load is approx. 0.15 W. The average efficiency is 71%. The power consumption of the base station max. 0,78 W.

The charging unit(s) supplied with the telephone set is/are equipped with an energy-efficient switching power supply (input 100~240 V<sub>AC</sub>, output 6 V<sub>DC</sub>, 150 mA). The zero load is approx. 0.17 W. The average efficiency is 67%. The power consumption of the charging station max. 0.22 W.

# **SWITEL**

## **Declaration of Conformity**



Diese Anlage entspricht der europäischen R&TTE Richtlinie.  
Für die komplette Konformitätserklärung nutzen Sie bitte den kostenlosen Download von unserer Website [www.switel.com](http://www.switel.com).

Cet équipement est conforme à la directive européenne R&TTE.  
Pour obtenir la déclaration de conformité intégrale, veuillez vous servir du téléchargement gratuit de notre site Internet [www.switel.com](http://www.switel.com).

Quest'apparecchiatura è conforme alla direttiva europea R&TTE.  
Per la dichiarazione di conformità completa si prega di voler usufruire del servizio gratuito di download dal nostro sito Internet [www.switel.com](http://www.switel.com).

This equipment complies with the European R&TTE directive.  
To view the complete Declaration of Conformity, please refer to the free download available at our web site: [www.switel.com](http://www.switel.com).

---

### **Service Hotline**

Bei technischen Problemen können Sie sich an unsere Service-Hotline unter Tel. 0900 00 1675 innerhalb der Schweiz (Kosten Swisscom bei Drucklegung: CHF 2.60/min) wenden.

S'il s'agit de problèmes techniques, vous pouvez vous adresser à notre hotline de service en Suisse en appelant le numéro 0900 00 1675 (frais Swisscom à la date d'impression de ce manuel : CHF 2.60/min).

In caso di problemi tecnici è possibile rivolgersi alla nostra hotline di assistenza tecnica chiamando al numero 0900 00 1675 valido per la Svizzera (spese da rete Swisscom alla data di stampa: CHF 2.60 / min).

In the event of technical problems, you can contact our hotline service, Tel. 0900 00 1675 within Switzerland (cost via Swisscom at time of going to print: CHF 2.60/min).