

MONACO

DO IT+GARDEN
MIGROS

6035.159.00000

Steckregal Etagère sans boulons Scaffale senza viti

Einfache Montage

Die Montageanleitung
finden Sie auf der
Rückseite

Assemblage facile

Vous trouvez
l'instruction
d'assemblage au verso

Montaggio facile

Istruzioni per
l'assemblaggio vedere
la parte posteriore

Masse

(Länge x Breite x Tiefe)

Dimensions

(longueur x largeur x profondeur)

173 x 90 x 40 cm

Dimensioni

(lunghezza x larghezza x profondità)

Belastbarkeit pro Boden

Capacité de charge par tablette
Capacità di carico per piani

85 kg

Farbe **verzinkt**
Couleur **galvanisée**
Colore **zincato**

4 Böden
tablettes
piani



Made in Belgium
Vertrieb/Distribution/Distribuzione:
Migros-Genossenschafts-Bund, CH-8031 Zürich
Migros France S.A., F-74100 Etrembières
Migros Deutschland GmbH, D-79539 Lörrach

M-INFLINE
CH-0848 84 0848
www.migros.ch
DO IT+GARDEN
MIGROS



MONACO

Steckregal
Etagère sans boulons
Scaffale senza viti

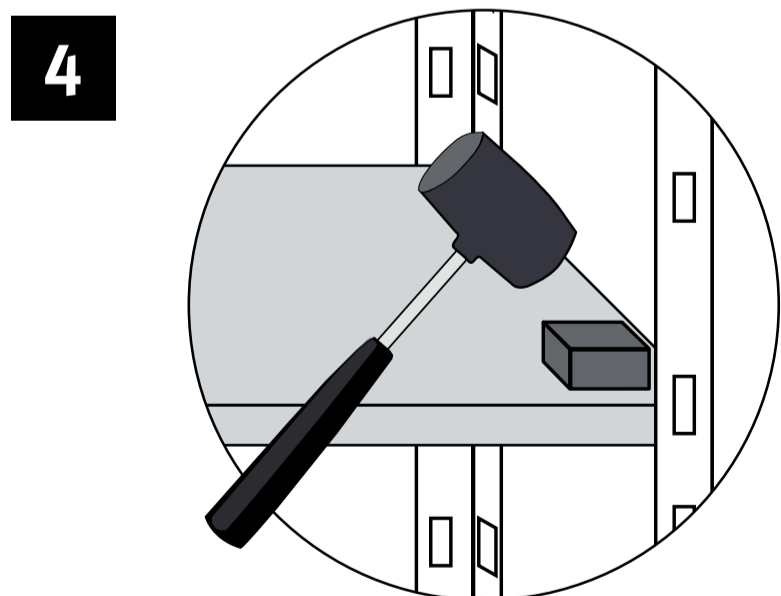
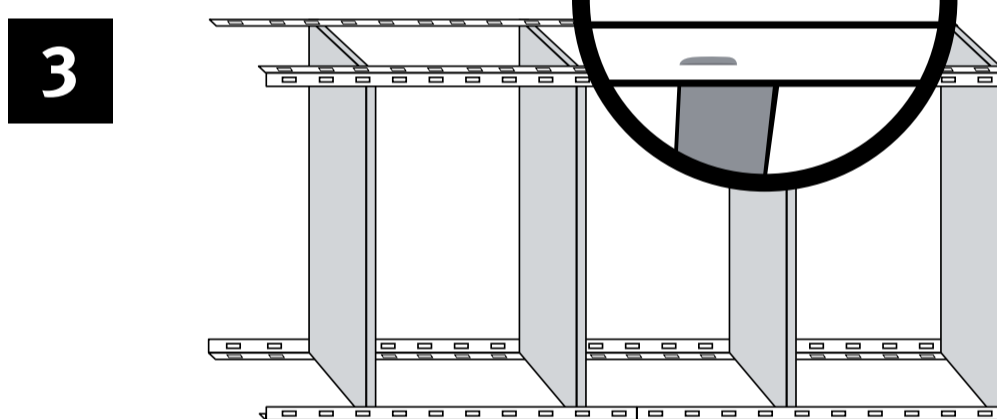
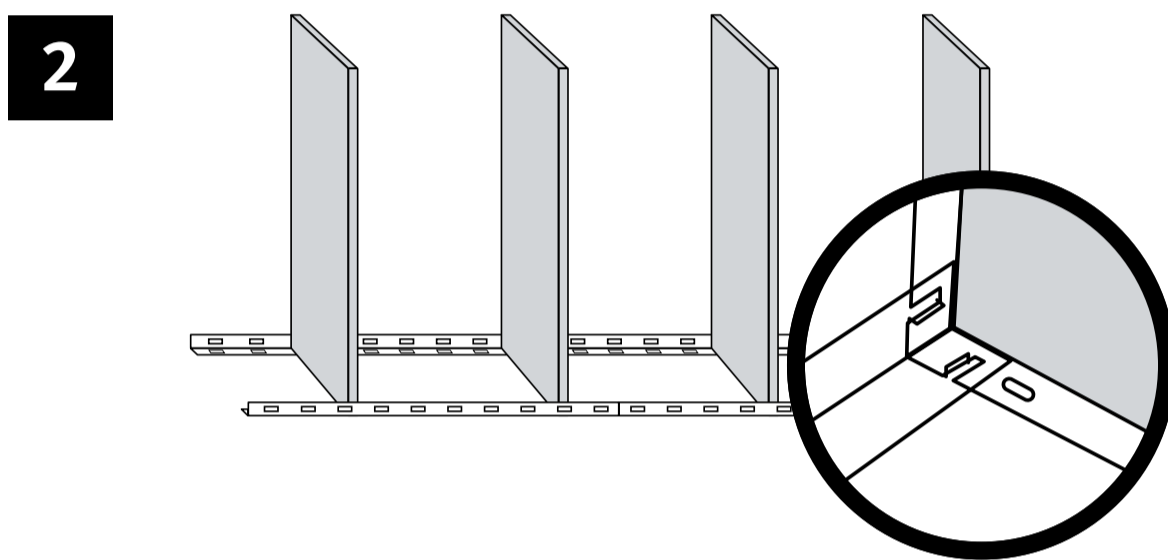
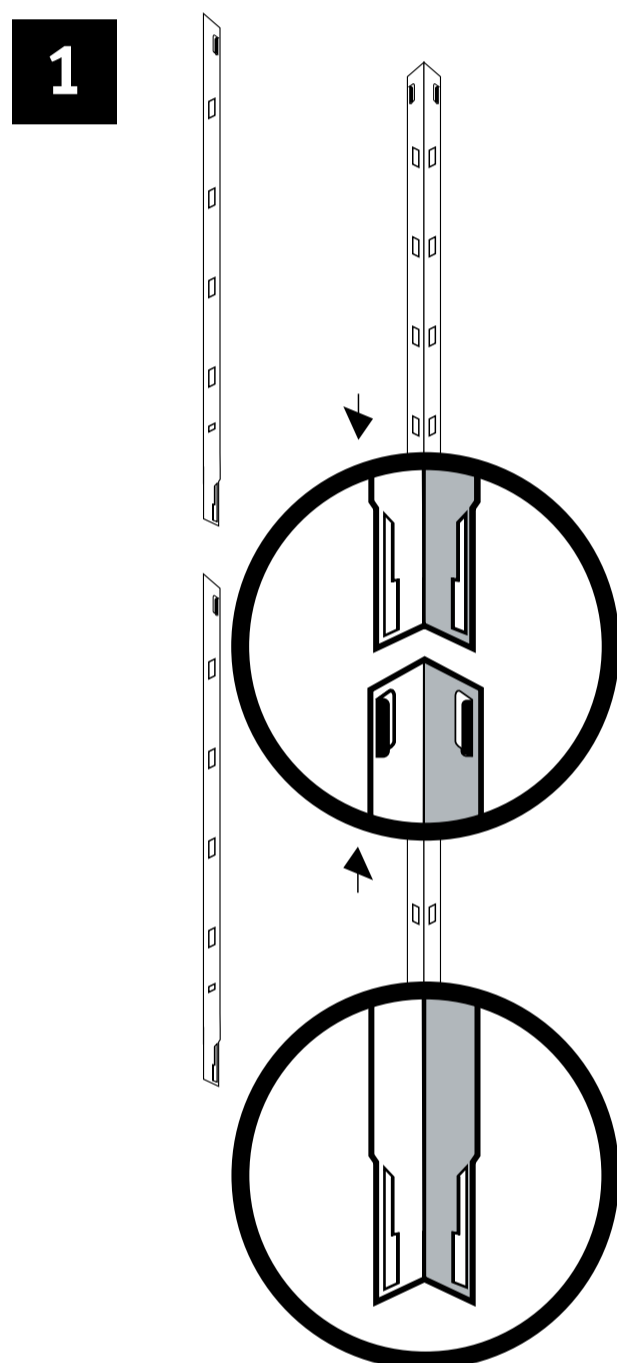
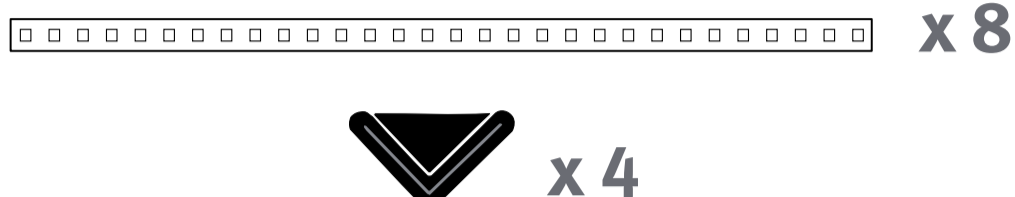

Verwenden Sie einen kleinen Holzblock!
Utilisez un petit bloc en bois!
Usare un pezzo di legno!

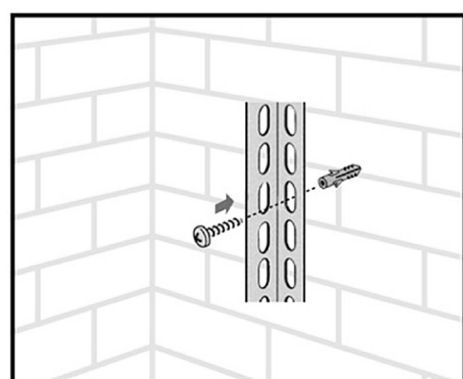
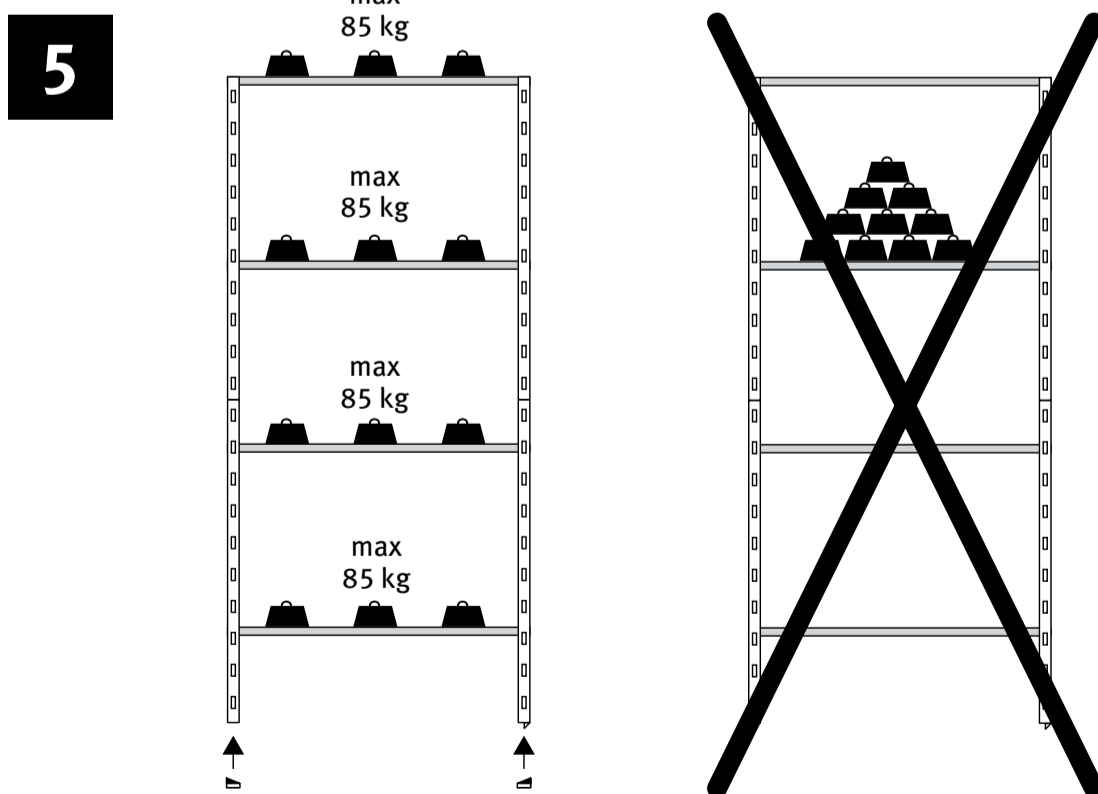

Zur Vermeidung von Verletzungen empfehlen wir bei der Montage das Tragen von Handschuhen! Für eine optimale Stabilität sollte das Regal mit zwei Schrauben an einer Wand befestigt werden.

Afin d'éviter des blessures, il est conseillé d'utiliser des gants pour le montage!
Pour une stabilité optimale il est recommandé de fixer l'étagère au mur avec deux vis.

Durante il montaggio suggeriamo di portare un paio di guanti per evitare ferite!
Vi raccomandiamo di fissare lo scaffale alla parete con due viti.