

# MONTAGEANLEITUNG

Instructione de montage  
 Instruction of installation  
 Istruzione di montaggio  
 Instrucciones de montaje

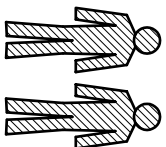

Kontrollnummer

4017.384 VARIANTA

**micasa**

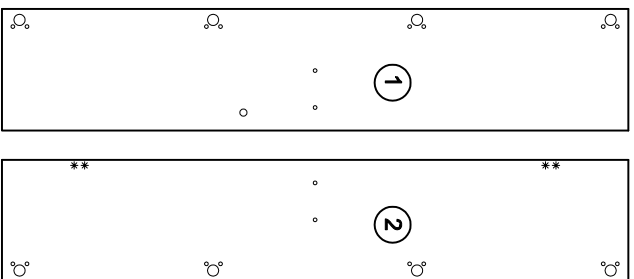
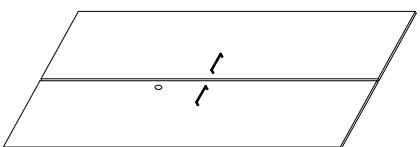

benötigtes Werkzeug  
 outils necessaires  
 tool necessary  
 attrezzi necessari  
 herramientas necesarias

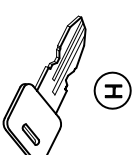
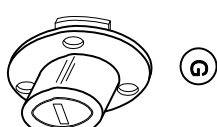
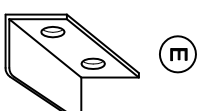
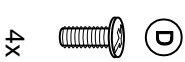
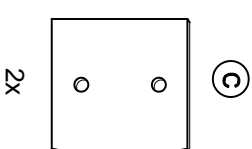
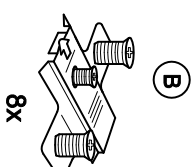
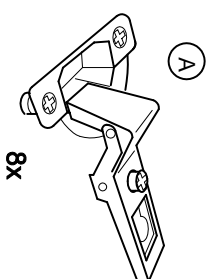
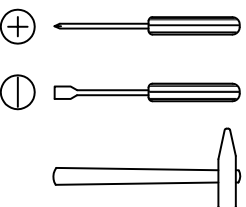

**1**

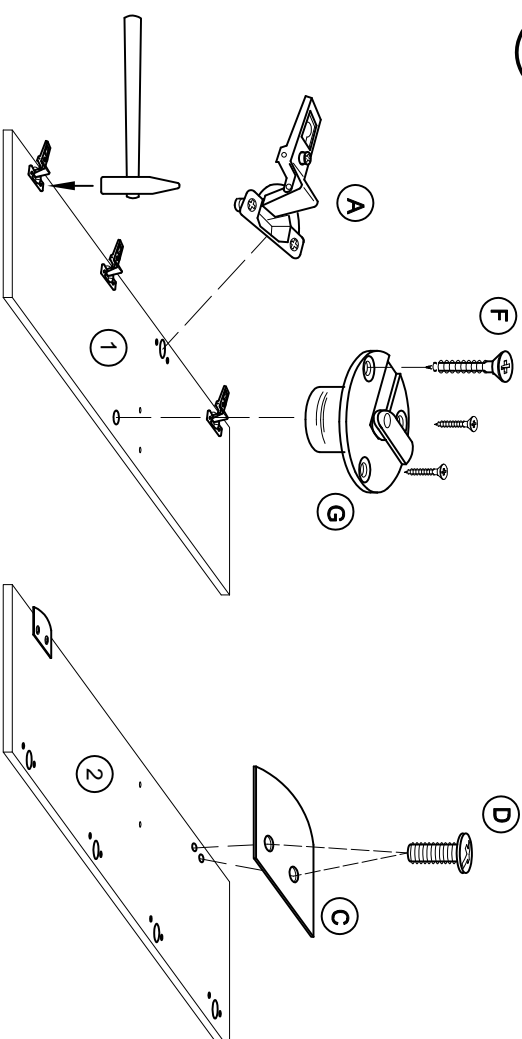

2

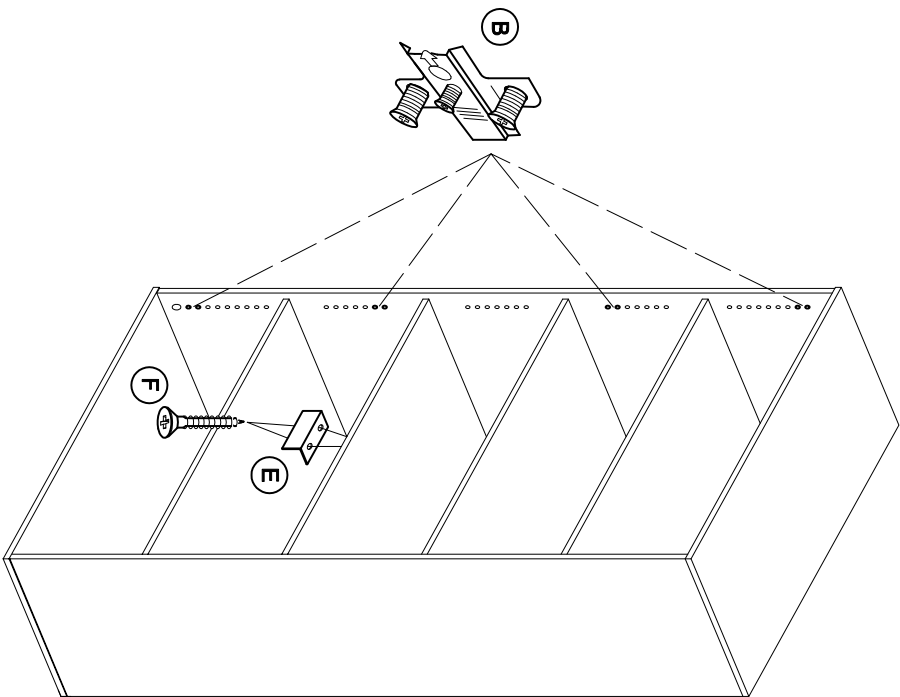

3

