

446-339
**BUILD
& PLAY**



WARNING: CHOKING HAZARD —
Small parts. Not for children under 3 years.



#5106



P.4



P.8



P.12



P.16

CONSTRUCTION TIPS

LES ASTUCES DE CONSTRUCTION
 KONSTRUKTIONSTIPS
 LE ASTUZZIE DELLA COSTRUZIONE
 LOS INGENIEROS DE LA CONSTRUCCION
 DICAS PARA A MONTAGEM
 KOKOONPANNON KIKAT
 BYGGKNEPEN
 ET PAR TIPS TIL BYGGEARBEJDET
 DE FINE KNEEPLIES VAN MET BOUWEN
 Το ΣΕΛΗΤΑ ΚΑΙΤΑ ΚΑΤΟΙΚΕΥΗΤ
 組み立ての秘訣

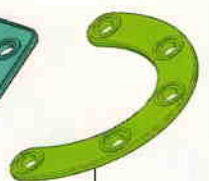

B941 X2



B924 X1



C170 X1



C170 X2



A561 (A0561) X1



A561 (A0561) X1



A350 (A0350) X1



A132 (A0132) X4

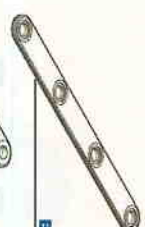

B712 X2

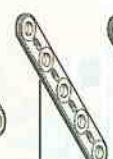

A005 (A0005) X2



A004 (A0004) X1



A003 (A0003) X1



A003 (A0003) X1



A632 (A0632) X1



B577 X3



B571 X2



A701 (A0701) X1



A042 (A0142) X1



A075 (A0075) X4



A074 (A0074) X4



A054 (A0054) X5



A051 (A0051) X14



A052 (A0052) X21



A052 (A0052) X1



A053 (A0053) X2



A053 (A0053) X5



A077 (A0077) X1



A077 (A0077) X1



A057 (A0057) X1



C085 X2



A545 (A0545) X4



A100 (A0100) X2



A101 (A0101) X2



A102 (A0102) X9



A090 (A0090) X1



A095 (A0095) X1



1

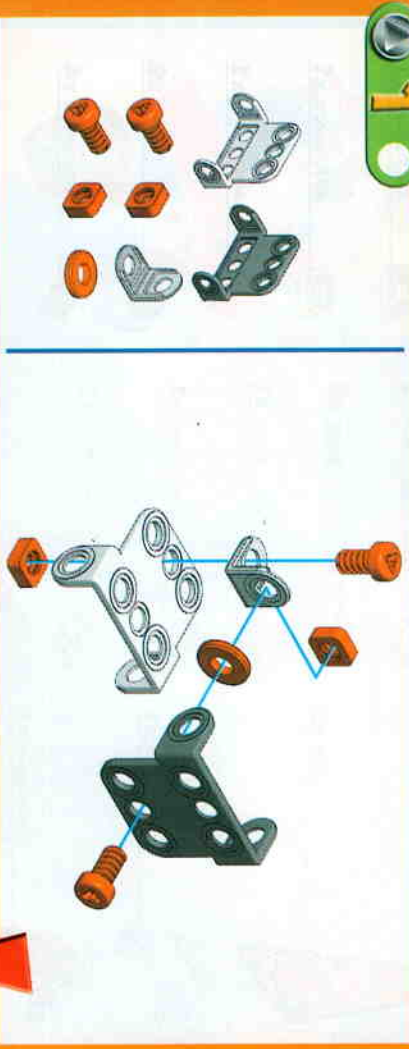

2

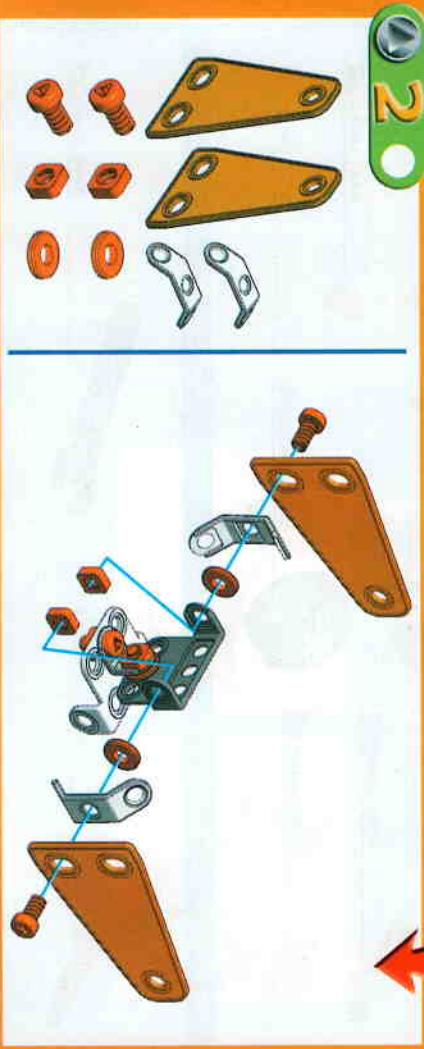

3



4

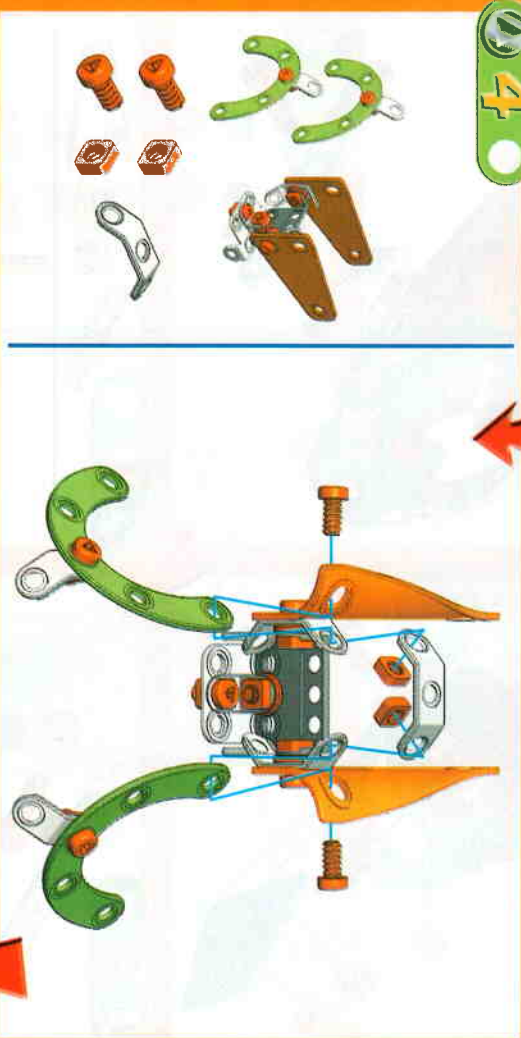

5

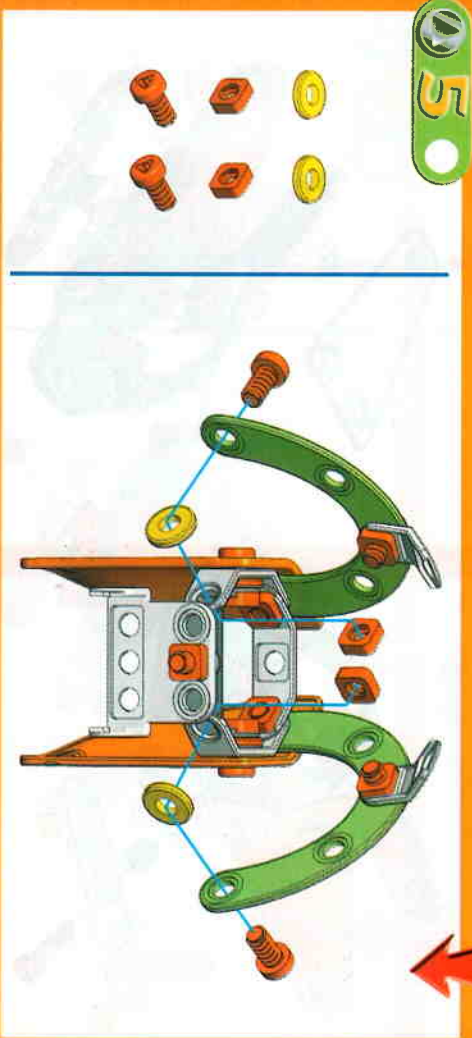



6

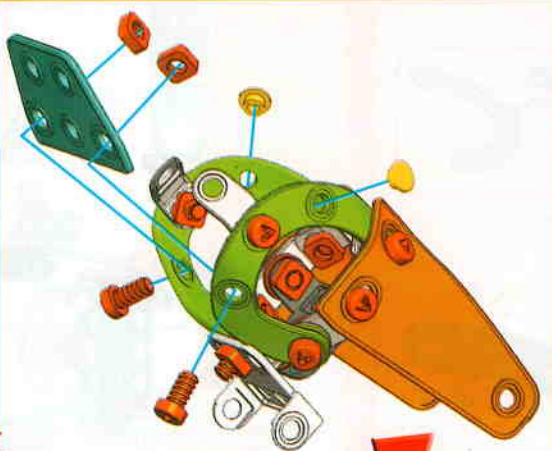

8



7



9

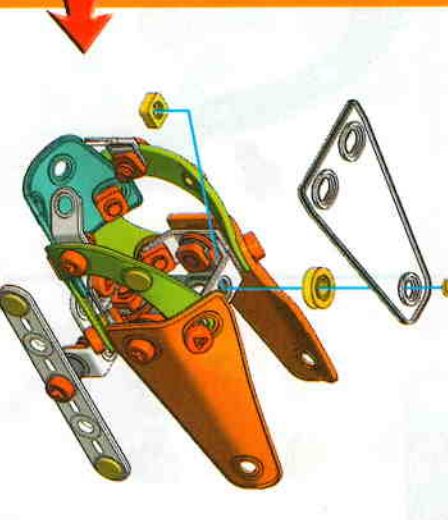

10

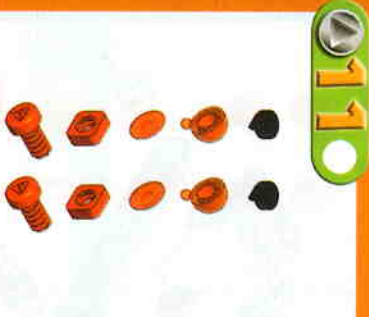
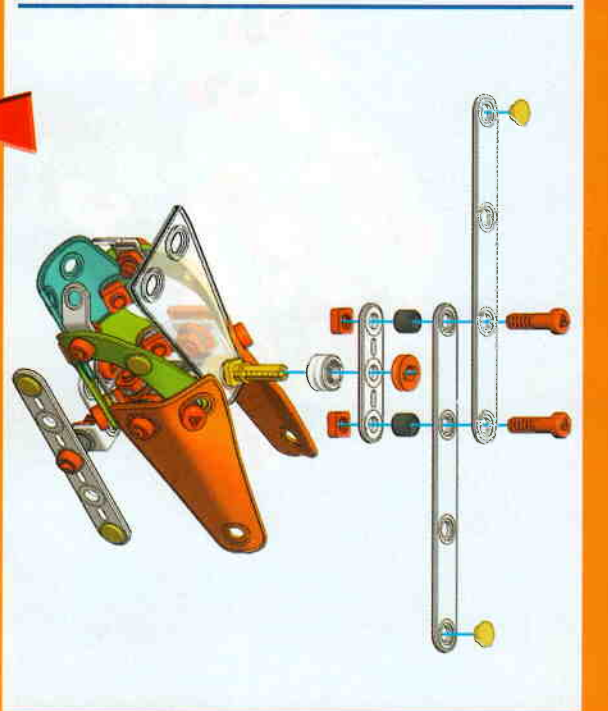

11



12

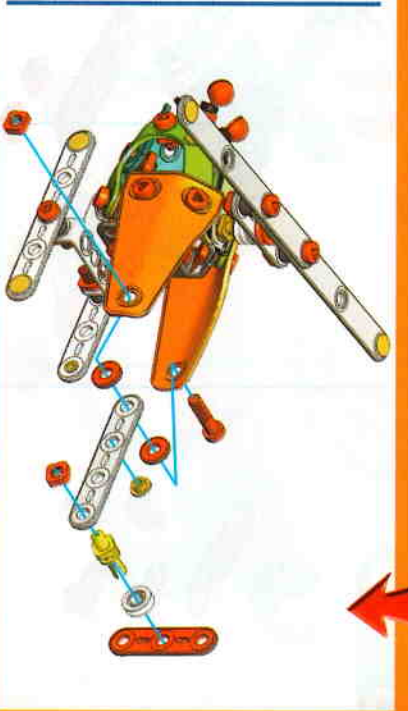

2

1

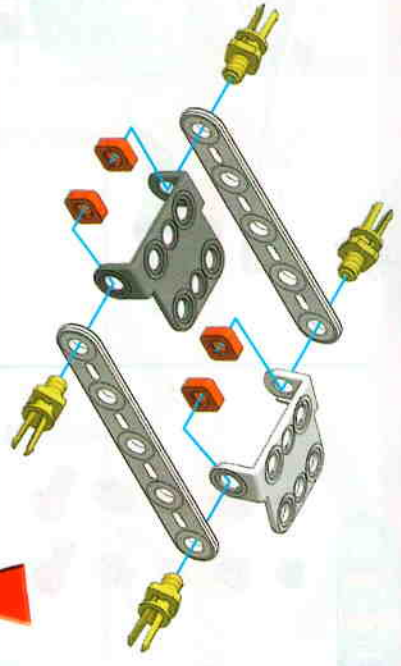
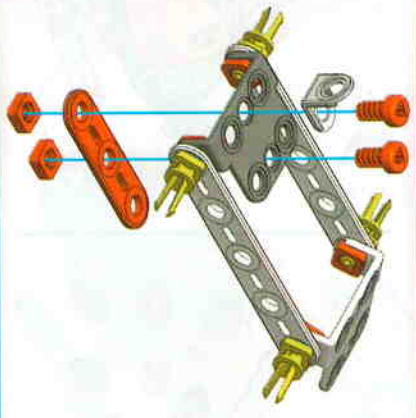
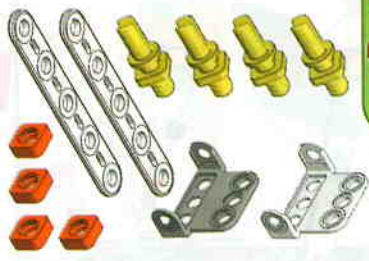

5

4

3

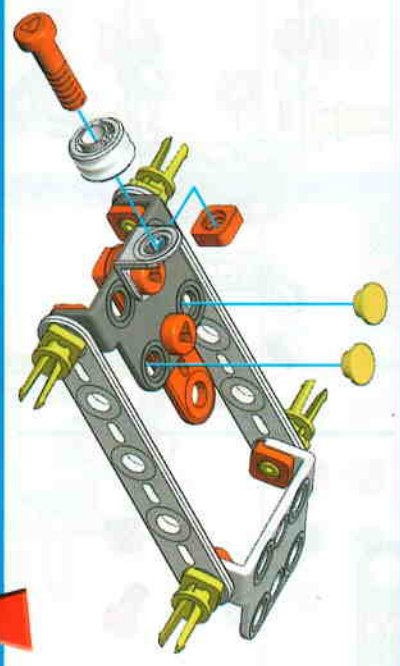
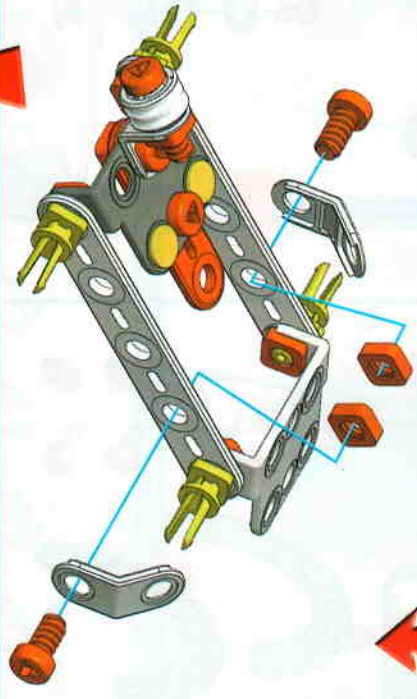
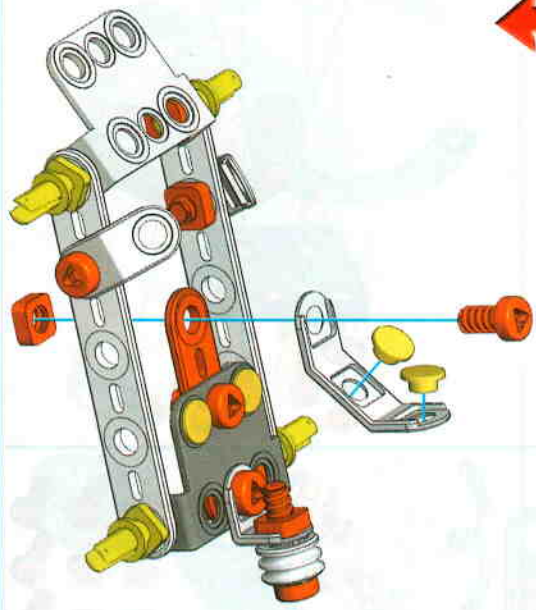

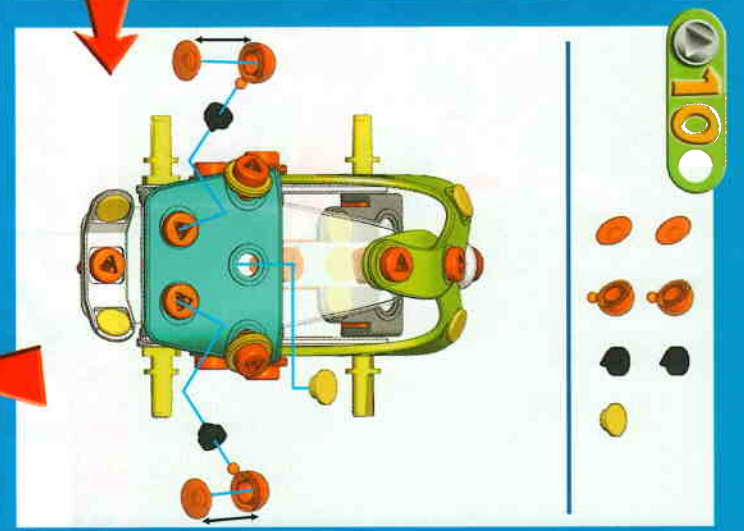
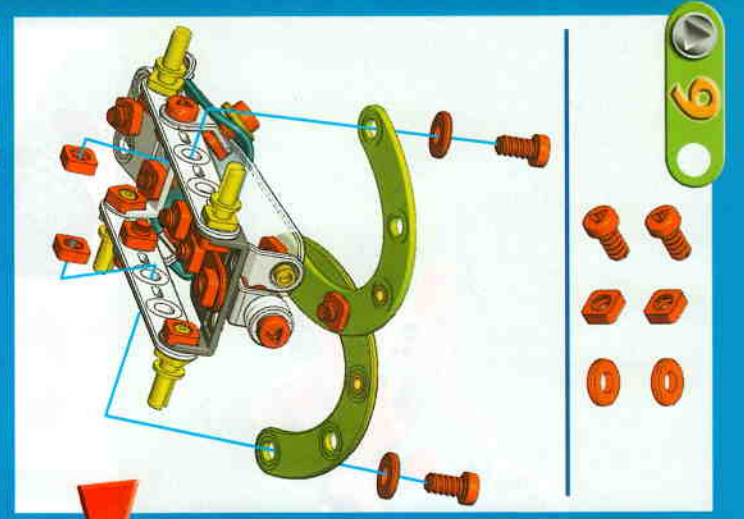
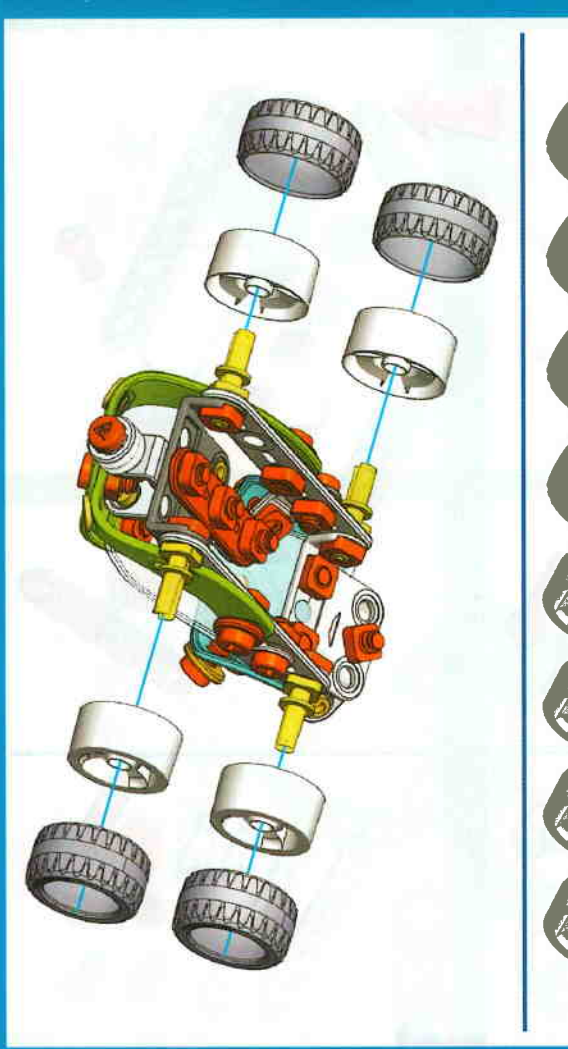
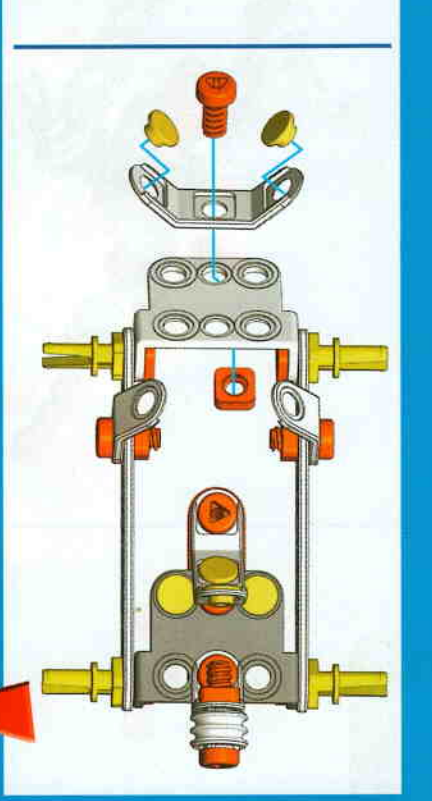
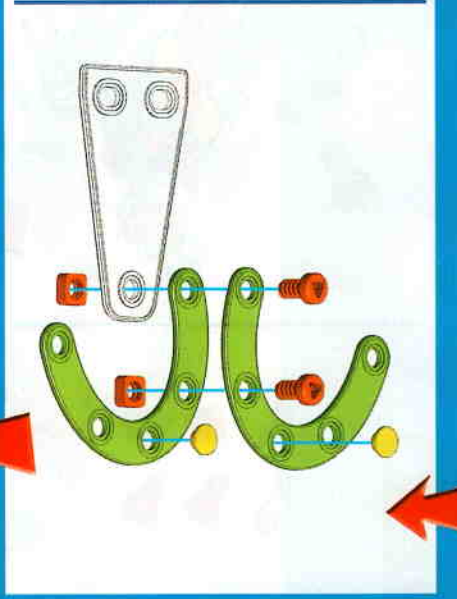
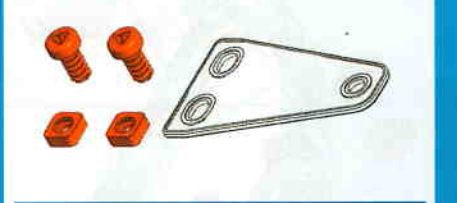
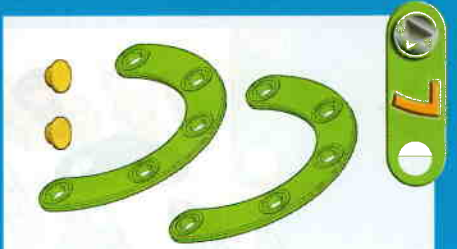
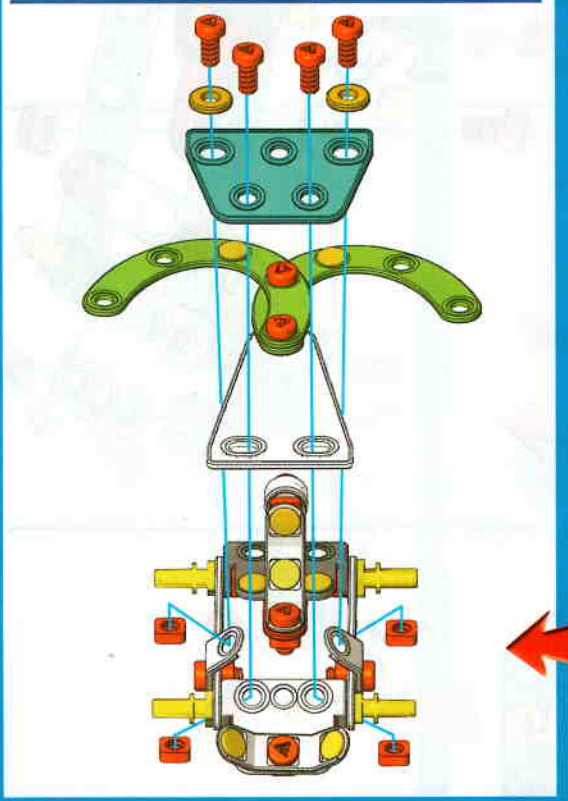
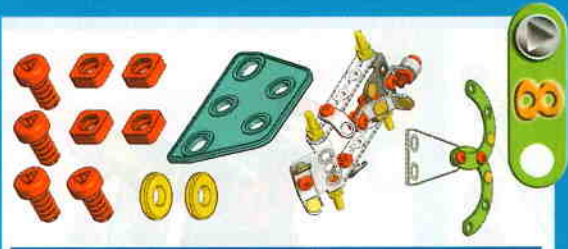

3

7

11

9

10



1

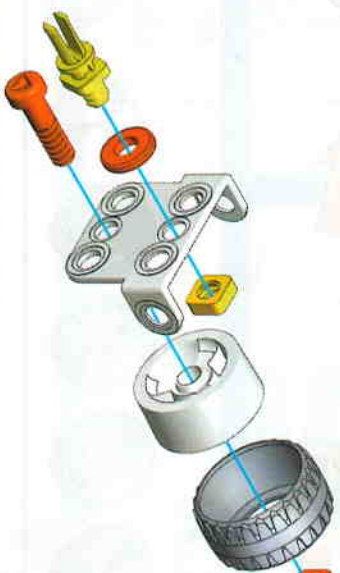

2

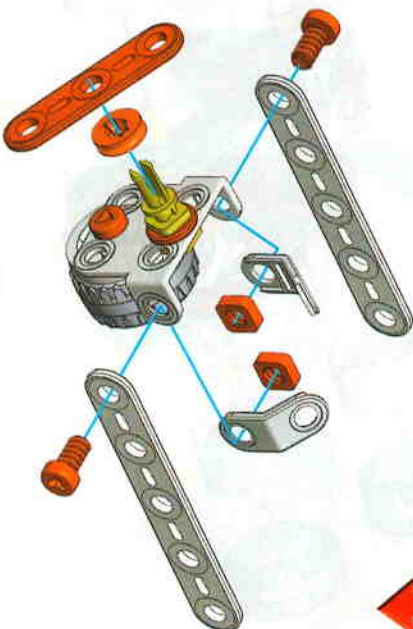

3

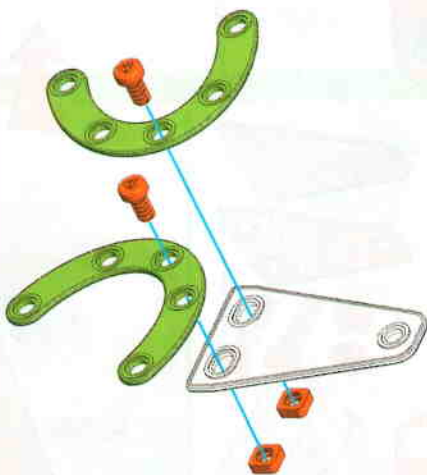

4



5

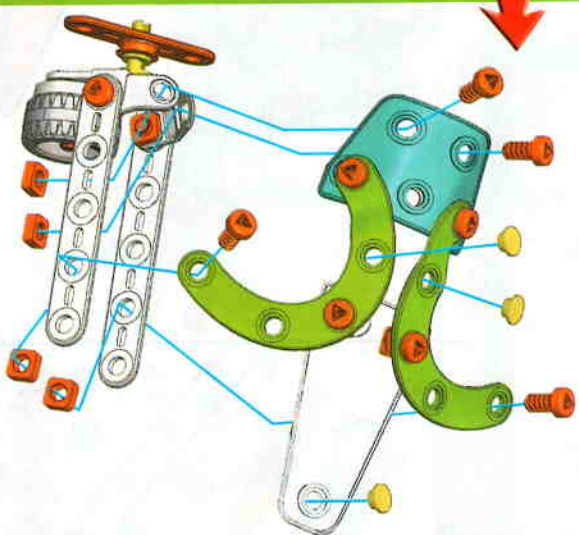
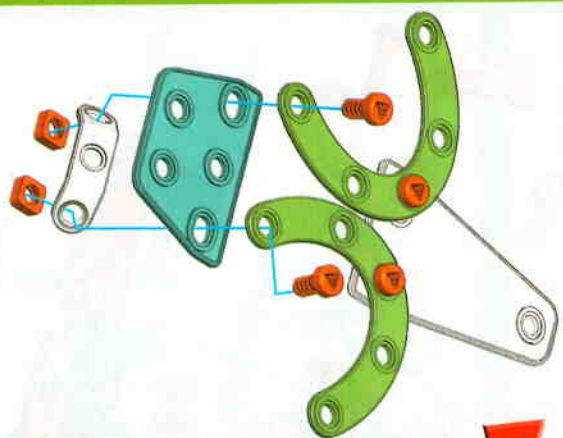

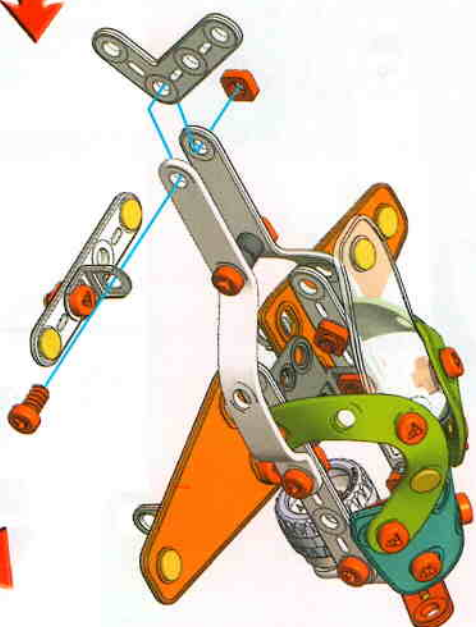
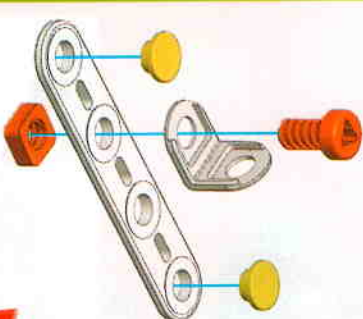
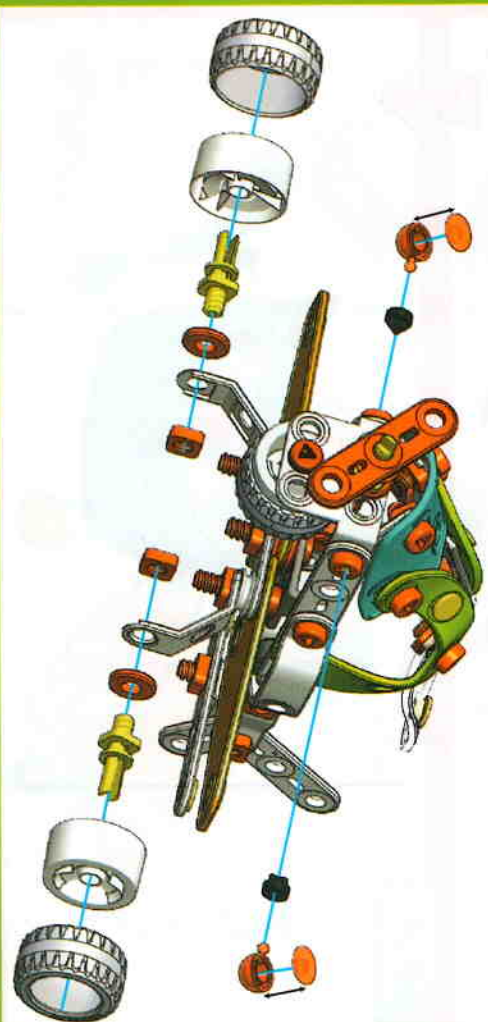
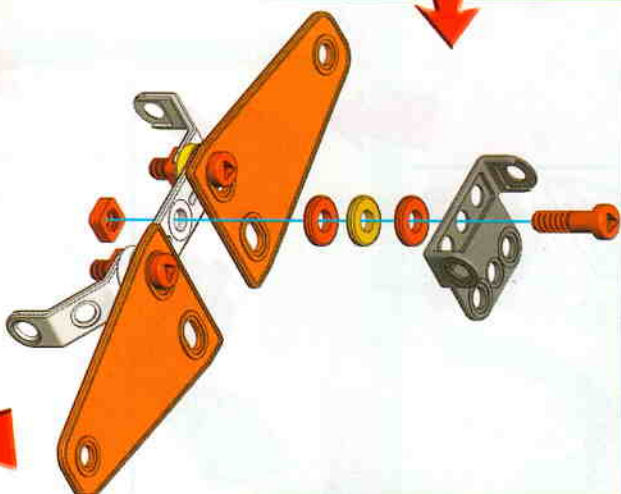
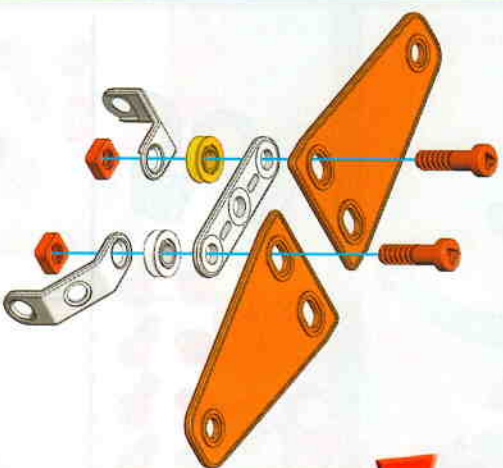
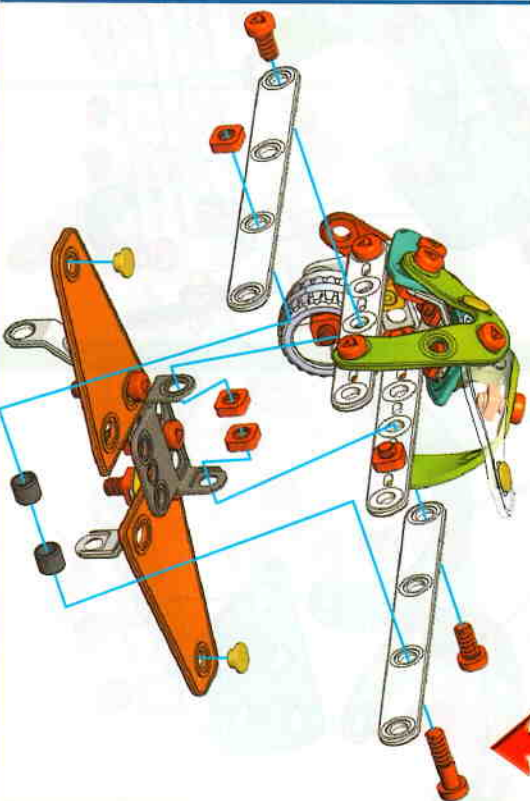



1

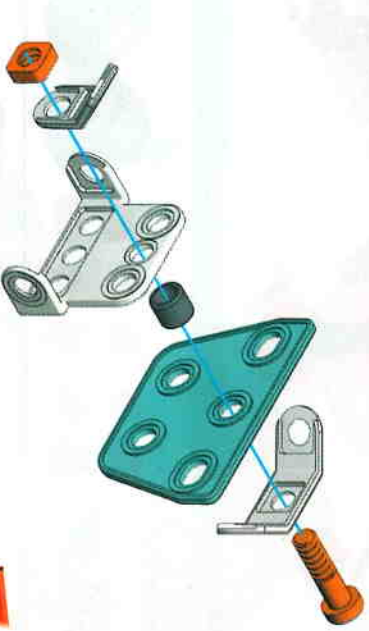

2

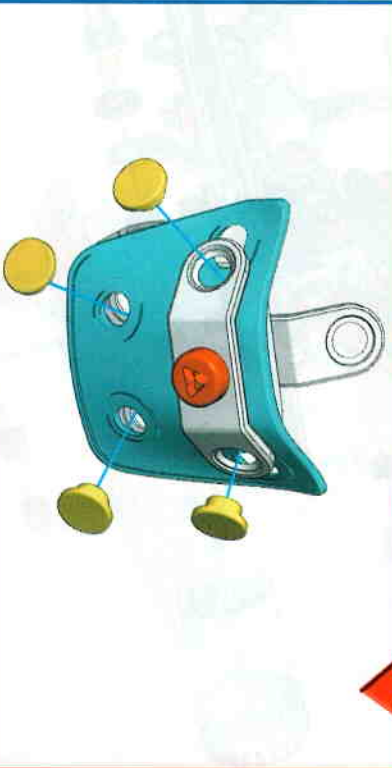
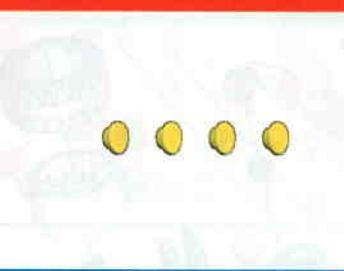

3

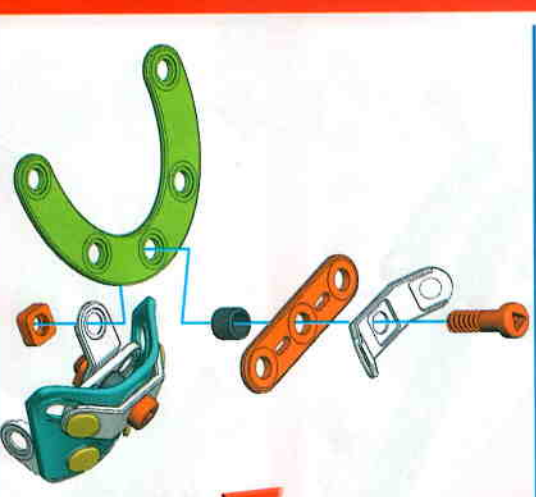

4

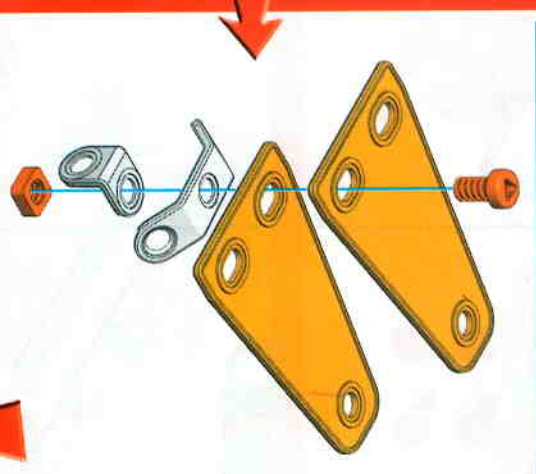

5

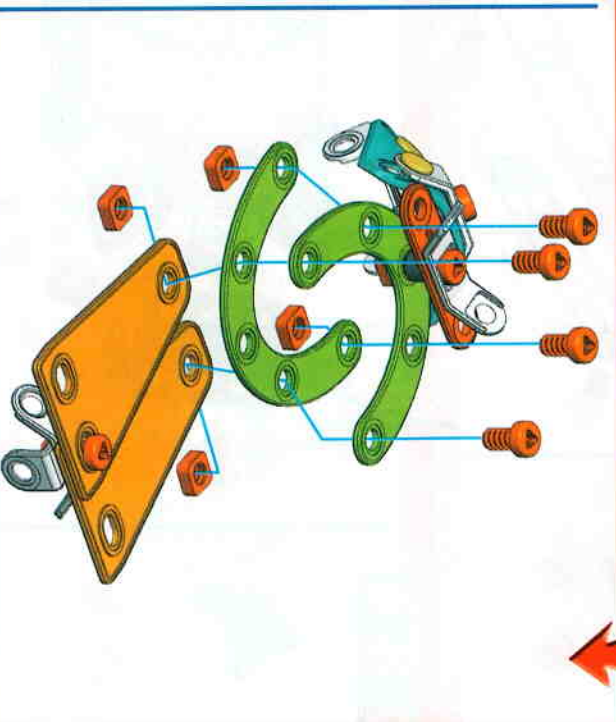

3

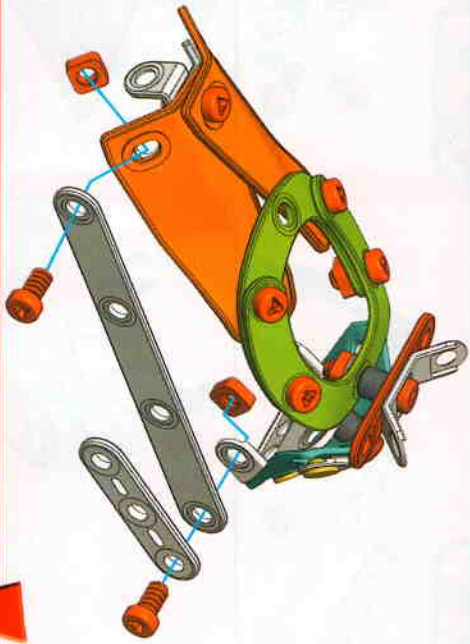
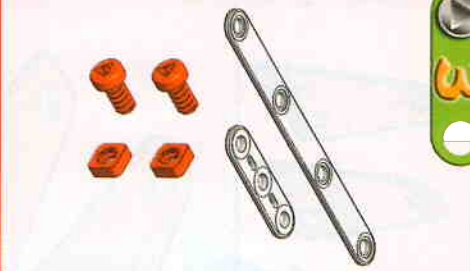

10

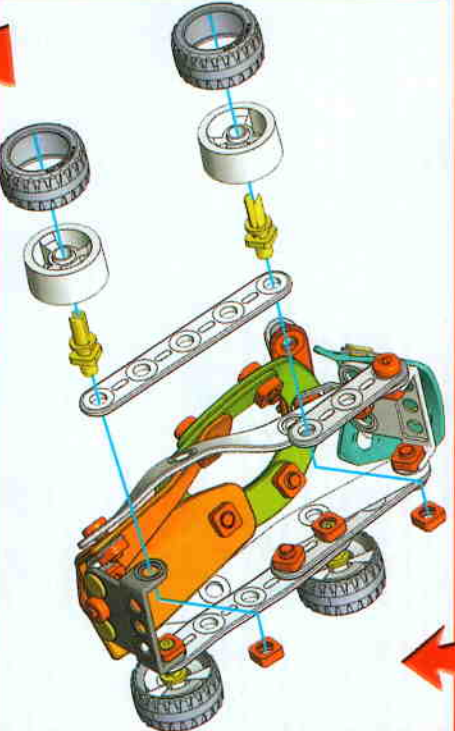
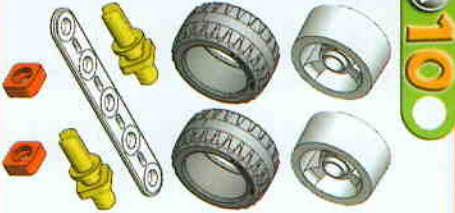

3

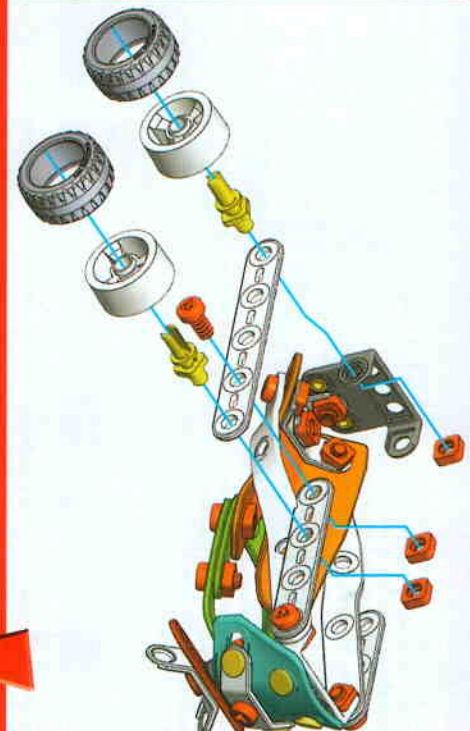
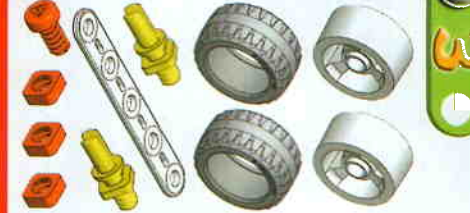

11

11

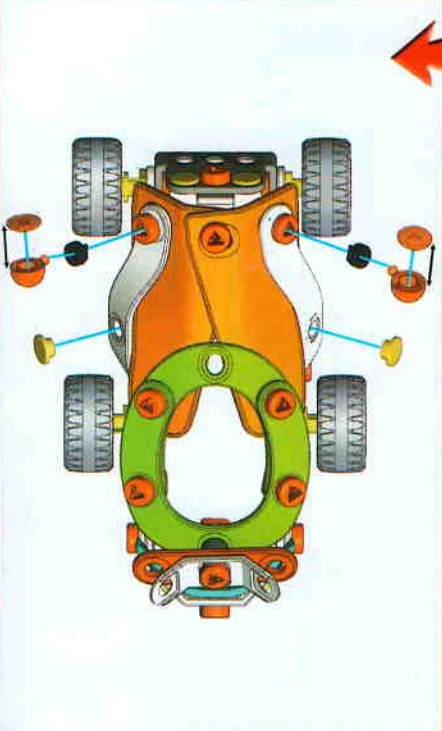
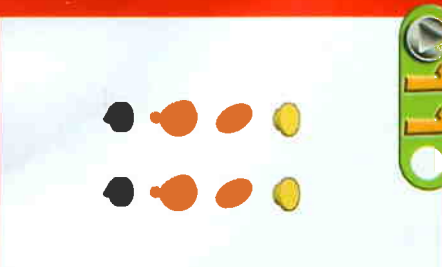

18



7

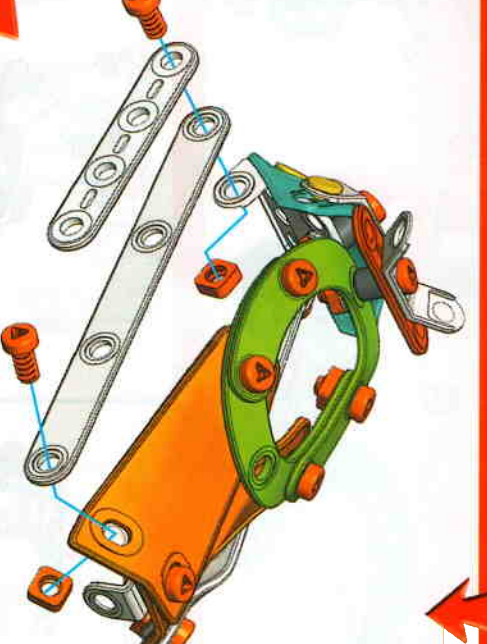

8

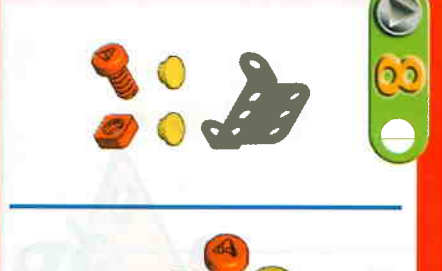

19

(USA) Many of the models and component parts are unique and original designs which are the property of MECCANO. They are protected by national legislation as industrial designs, trademarks and/or copyrights throughout many countries. For detailed information, please contact: MECCANO. Meccano shall have no responsibility for (I) failure to follow instructions, (II) use of parts for any purpose other than as specified in the instructions, (III) any alteration of any parts or components. MECCANO respects children's safety: all models are set up by adults.

(F) De nombreux modèles et pièces sont des créations originales, propriétés de MECCANO et sont protégés par les législations nationales sur les dessins et modèles, marques et/ou droits d'auteurs. Pour toute information, merci de contacter : MECCANO. La responsabilité de MECCANO ne saurait être engagée en cas d'accident survenu à la suite (I) du non respect des instructions de montage (II) d'une utilisation des pièces autre que celle proposée dans le notice (III) d'une altération ou de la modification des pièces. La société MECCANO respecte la sécurité des enfants : ses modèles sont testés par des enfants.

(D) Zahlreiche Modelle und Teile sind Erfindungen und Eigentum der Firma MECCANO. Sie sind durch Inhaberschaft über Zeichnungen und Modelle sowie Warenzeichen und/oder Urheberrechte geschützt. Für zusätzliche Auskünfte wenden Sie sich bitte an : MECCANO. Die Firma Meccano haftet nicht für Unfälle, die aus der (I) Nichtbeachtung der Bauanleitung, der (II) Verwendung anderer als in der Bauanleitung angegebenen Teile oder der (III) Änderung oder Abweichungen der Teile resultieren. Alle Modelle der Firma Meccano wurden von Kindern getestet und entsprechen den Sicherheitsnormen.

(I) Numerosi modelli e pezzi sono creazioni originali della MECCANO e sono protetti dalle legislazioni nazionali su disegni e modelli, marchi e/o diritti d'autore. Per qualsiasi informazione, viaggiate prendere contatto con : MECCANO. Meccano declina ogni responsabilità in caso di incidenti sopravvenuti in seguito (I) al non rispetto delle istruzioni di montaggio (II) all'ulteriore uso dei pezzi per funzioni diverse da quelle previste nel manuale (III) all'alterazione e/o modifica dei pezzi. La società MECCANO rispetta la sicurezza dei bambini : i suoi modelli vengono testati dai bambini stessi.

(E) Numerosos modelos y piezas son creaciones originales, propiedades de MECCANO y están protegidos por las legislaciones nacionales en lo que concierne a los dibujos y modelos, marcas y/o derechos de autor. Para cualquier información, sírvase ponerse en contacto con : MECCANO. MECCANO carece de responsabilidad en caso de accidente debido a (I) el incumplimiento de las instrucciones de montaje (II) una utilización de las piezas diferente a la que se indica en las instrucciones (III) una alteración o modificación de las piezas. La sociedad MECCANO respeta la seguridad de los niños : sus modelos están probados por niños.

(P) Varios modelos e peças são criações originais, propriedades da MECCANO e são protegidos pelas legislações nacionais relativas aos desenhos e modelos, às marcas e/ou aos direitos de autor. Para qualquer informação, e favor contactar : MECCANO. A Sociedade MECCANO não poderá ser responsabilizada pelos acidentes provocados (I) pelo não de cumprimento das instruções de montagem (II) pelo uso diferente das peças ou (III) pelo modificação ou alteração dos peças. A Sociedade MECCANO respeita a segurança dos crianças : os seus modelos foram testados por crianças.

(S) Mange modeller och delar bildar en unik och original förpackning vilken är MECCANO egendom. Dessa modeller och delar är skyddade genom lagstiftning såsom industriell förpackning, varumärke och/eller förpackningsmärken i ett flertal länder. För mer detaljerad information, var vänlig och kontakta MECCANO. MECCANO främjar sig inte i handlingar som oavsiktligt följt av (I) att monteringsinstruktionerna inte har respekterats (II) en annan användning av delarna än den som står i anvisningen (III) en förändring eller förändring av delarna. Företaget MECCANO respekterar barnsäkerheten : modellerna har testats av barn.

(EN) Usat modelle je osat ovaj MECCANO, n omeisurita ojeva otkupovna suvlast. Ne ovaj konsolidirani hallo sugovotno hevlito monolitoj, tvoromarketa je/jei kopiriranih kuzica. Pyrijama otkupovna yhteyden MECCANO kom kokissa osoon illyvosa kysymyksissa. MECCANO ei vastaa etka kato seurustusta syste sohmella omistomuksia: (I) ohjeiden voutaan kokoonpanon, (II) muuten kuin ohjeissa ehdotetun osien kytto, (III) osien muuttelu, joi eti korjauksiaan kyttya. MECCANO yhtiis huolehtii lasten turvallisuuden: lapset ovat testanneet mallimme.

(DK) Vore mange modeller og dele er originale fremstillinger og ejes af MECCANO. Tegninger, modeller, fabrikmærker og oplysninger er beskyttede i hvert land. Yderligere oplysninger kan fås hos MECCANO. MECCANO frsiger sig ethvert ansvar, sftrent der er sket uretled forrsaget af (I) at monteringsinstruktionerne ikke er blevet overholdt, (II) at delene er blevet brugt til andre formål, end dem der er beskrevet i betjeningsvejledningen, (III) eller at delene er blevet beskadiget eller ændret. MECCANO overholder sikkerhedsreglerne for børn. Alle modeller testes af børn.

(NL) Veel modellen en onderdelen zijn originele ontwerpen en eigendom van MECCANO en worden beschermd door de nationale wetgevingen op het gebied van modellen, merken en/of auteursrechten. Voor informatie gelieve contact op te nemen met MECCANO. De verantwoordelijkheid van MECCANO is uitsluitend in geval van ongevallen voortvloeiend uit het niet naleven van de montage-instructies (I) uit het gebruik van andere onderdelen dan die zoals vermeld in de handleiding (II) of uit het veranderen of modificeren van de onderdelen (III). De firma MECCANO aanst de veiligheid van de kinderen in acht : de modellen zijn door kinderen getest.

(GR) Πολλά μοντέλα και ανταλλακτικά είναι αυθεντικά, ιδιοκτησία της MECCANO και προστατεύονται από τις εθνικές νομοθεσίες για τα πατέντες, εμπορικά ή άλλα δικαιώματα πνευματικής ιδιοκτησίας. Για κάθε πληροφορία, παρακαλούμε επικοινωνήστε με τη MECCANO. Η εταιρεία της MECCANO δεν διασφαλίζει σε περίπτωση ατυχήματος που είναι αποτέλεσμα (I) μη απόλυτης τήρησης οδηγιών, (II) χρήσης των εξαρτημάτων διαφορετικά από αυτά που προτείνονται στις οδηγίες (III) αλλαγών ή αλλαγών ή τροποποιήσεων MECCANO σχετικά με οποιαδήποτε τμήμα, το οποίο να πορεύεται από τα παιδιά.

(PT) Muitos dos modelos e peças são criações originais, propriedades da MECCANO e são protegidos pelas legislações nacionais em relação a desenhos e modelos, marcas e/ou direitos de autor. Para qualquer informação, por favor contactar a MECCANO. A Sociedade MECCANO não poderá ser responsabilizada por acidentes provocados (I) pelo não cumprimento das instruções de montagem (II) pelo uso diferente das peças ou (III) pelo modificação ou alteração dos peças. A Sociedade MECCANO respeita a segurança das crianças : os seus modelos foram testados por crianças.

Made in China for/Fabriqu  en Chine pour/Fabricado en China por.



363, avenue de Saint Eup ry

62100 Calais - France

https://www.meccano.com

https://www.erektor.com

  11/2008 MECCANO

MECCANO and EREKTOR are exclusive trademarks of MECCANO

All rights reserved

735106104111

