

WARNING: CHOKING HAZARD —
Small parts. Not for children under 3 years.

10 mechanical toys

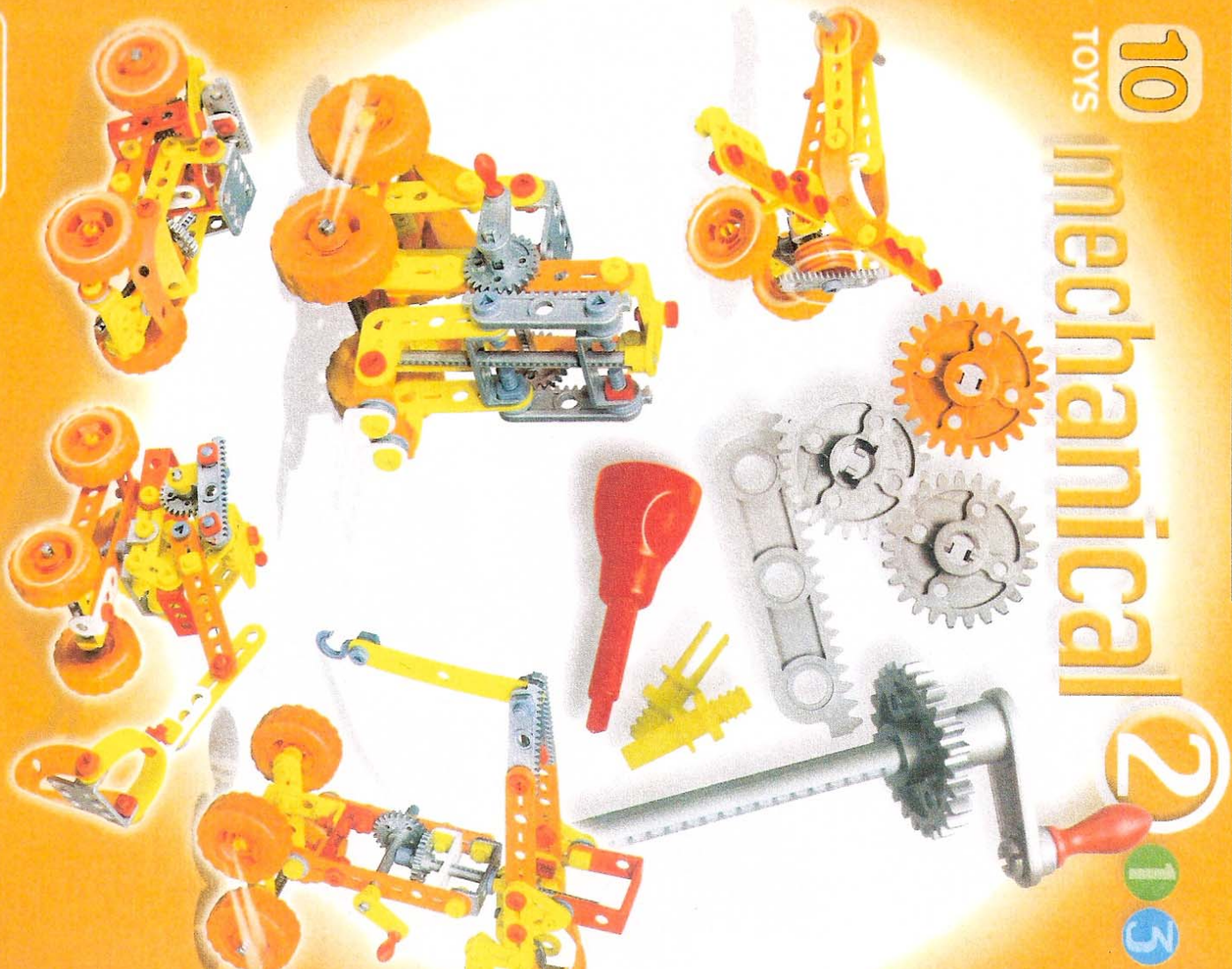

760261

(A) Many of the models and component parts are unique and original designs which are the property of MECCANO. They are protected by national legislation on industrial design, trademarks and/or copyrights throughout many countries. For detailed information please contact MECCANO.

(B) Meccano shall have no responsibility for (i) failure to follow instructions, (ii) use of parts for any purpose other than as specified in the instructions, (iii) any alteration of any parts or components. MECCANO respects children's safety, all models are tested by children.

(C) De constructie modellen of onderdelen zijn origineel ontworpen, gepatenteerd of anderszins beschermd. Het is de bedoeling dat deze modellen en onderdelen uitsluitend worden gebruikt voor de doeleinden waarvoor zij bestemd zijn. MECCANO aanvaardt geen aansprakelijkheid voor schade van welke aard ook voortvloeiende uit het gebruik van de modellen of onderdelen anderszins dan zoals bedoeld in de instructies. MECCANO aanvaardt geen aansprakelijkheid voor schade van welke aard ook voortvloeiende uit het gebruik van de modellen of onderdelen anderszins dan zoals bedoeld in de instructies.

(D) Zahlreiche Modelle und Teile sind Erfindungen und Eigentum der Firma Meccano. Sie sind durch Patentgesetz, Marken- und Urheberrecht und durch nationale Gesetze in vielen Ländern geschützt. Für zusätzliche Abschlüsse wenden Sie sich bitte an: MECCANO. Die Firma Meccano hat sich nicht für Unfälle, die aus der (i) Nichtbeachtung der Bauanleitung, der (ii) Verwendung anderer als in der Bauanleitung angegebenen Teile oder der (iii) Änderung oder Modifikation der Teile resultieren. Alle Modelle der Firma Meccano wurden von Kindern getestet und entsprechen den Sicherheitsnormen.

(E) Numerosi modelli e pezzi sono creazioni originali della MECCANO e sono protetti dalle leggi nazionali e internazionali sui disegni e modelli, marchi e/o diritti di autore. Per qualsiasi informazione, rivolgete il presente contatto con: MECCANO. Meccano assume ogni responsabilità in caso di incidenti sopravvenuti in seguito (i) a non rispetto delle istruzioni di montaggio (ii) utilizzo dei pezzi per funzioni diverse da quelle previste nel manuale (iii) alterazioni e/o modifiche dei pezzi. La società MECCANO rispetta la sicurezza dei bambini: i suoi modelli vengono testati dai bambini stessi.

(F) Numerosos modelos y piezas son creaciones originales, patentadas, o bien protegidas por los legislaciones nacionales, marcas y/o derechos de autor. Para cualquier información, sírvase ponerse en contacto con: MECCANO. MECCANO acepta de responsabilidad en caso de accidentes de: (i) el incumplimiento de las instrucciones de montaje (ii) uso incorrecto de los piezas diferentes a la que se indica en las instrucciones (iii) una alteración o modificación de las piezas. La sociedad MECCANO respeta la seguridad de los niños: sus modelos están probados por niños.

(G) Versus modelis e partes são criações originais, patentadas, ou protegidas e são protegidas pelas legislações nacionais, marcas, direitos de autor e marcas, os direitos de autor. Para quaisquer informações, a favor contactar: MECCANO. A Sociedade MECCANO não poderá ser responsabilizada pelos acidentes, porquanto: (i) não foram seguidas as instruções de montagem (ii) pelo uso indevido das peças ou (iii) pelo modificação ou alteração das peças. A Sociedade MECCANO respeita a segurança dos crianças: os seus modelos foram testados por crianças.

(H) Meccano modeller och delar tillhör en unik och original konstruktion vilken är MECCANO:s egendom. Dessa modeller och delar är skyddade genom lagstiftning som rör industriell konstruktion, varumärken och/eller upphovsrätt i det fysikaliska området. För mer detaljerad information, var vänlig och kontakta MECCANO. MECCANO förnekar sig allt ansvar i samband med olycka till följd av (i) att monteringsinstruktionerna inte har respekterats (ii) en annan användning av delarna än den som står i instruktionen (iii) en förändring eller förändring av delarna. Företaget MECCANO respekterar barns säkerhet: modellerna har testats av barn.

(I) Veel modellen en onderdelen zijn origineel ontworpen en eigendom van MECCANO en worden beschermd door de nationale wetgeving op het gebied van modellen, merken en/of auteursrechten. Voor informatie gelieve contact op te nemen met MECCANO. De verantwoordelijkheid van MECCANO is uitsluitend in geval van niet-naleving van de instructies of het niet-nutten van de montage-instructies (i) uit het gebruik van andere onderdelen dan die zoals vermeld in de handleiding (ii) of uit het veranderen of modificeren van de onderdelen (iii). De firma MECCANO respecteert de veiligheid van de kinderen: de modellen zijn door kinderen getest.

(J) Tolle járuléka és alkatrészek eredetileg eredetileg a MECCANO-tól származóak, és jogszabályok által védettek. A MECCANO nem vállal felelősséget a gyermekek által okozott sérülésekért, amelyek a (i) nem megfelelő használatból, a (ii) a gyártási utasításoktól való eltérésekből, vagy a (iii) a szerelési utasításoktól való eltérésekből adódnak. A MECCANO nem vállal felelősséget a gyermekek által okozott sérülésekért, amelyek a (i) nem megfelelő használatból, a (ii) a gyártási utasításoktól való eltérésekből, vagy a (iii) a szerelési utasításoktól való eltérésekből adódnak.

(K) Versus modelis e partes são criações originais, patentadas, ou protegidas e são protegidas pelas legislações nacionais, marcas y/o derechos de autor. Para cualquier información, sírvase ponerse en contacto con: MECCANO. MECCANO acepta de responsabilidad en caso de accidentes de: (i) el incumplimiento de las instrucciones de montaje (ii) uso incorrecto de los piezas diferentes a la que se indica en las instrucciones (iii) una alteración o modificación de las piezas. La sociedad MECCANO respeta la seguridad de los niños: sus modelos están probados por niños.

(L) Versus modelis e partes são criações originais, patentadas, ou protegidas e são protegidas pelas legislações nacionais, marcas y/o derechos de autor. Para cualquier información, sírvase ponerse en contacto con: MECCANO. MECCANO acepta de responsabilidad en caso de accidentes de: (i) el incumplimiento de las instrucciones de montaje (ii) uso incorrecto de los piezas diferentes a la que se indica en las instrucciones (iii) una alteración o modificación de las piezas. La sociedad MECCANO respeta la seguridad de los niños: sus modelos están probados por niños.

(M) Versus modelis e partes são criações originais, patentadas, ou protegidas e são protegidas pelas legislações nacionais, marcas y/o derechos de autor. Para cualquier información, sírvase ponerse en contacto con: MECCANO. MECCANO acepta de responsabilidad en caso de accidentes de: (i) el incumplimiento de las instrucciones de montaje (ii) uso incorrecto de los piezas diferentes a la que se indica en las instrucciones (iii) una alteración o modificación de las piezas. La sociedad MECCANO respeta la seguridad de los niños: sus modelos están probados por niños.



345, avenue de Saint Exupéry
62100 Calais - France
<http://www.meccano.com>
© 01/2008 MECCANO
All rights reserved

760261 104 111

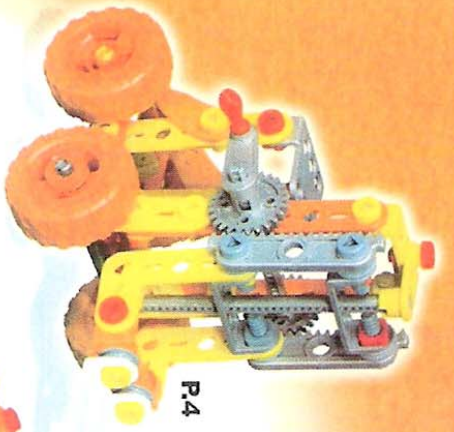

P4

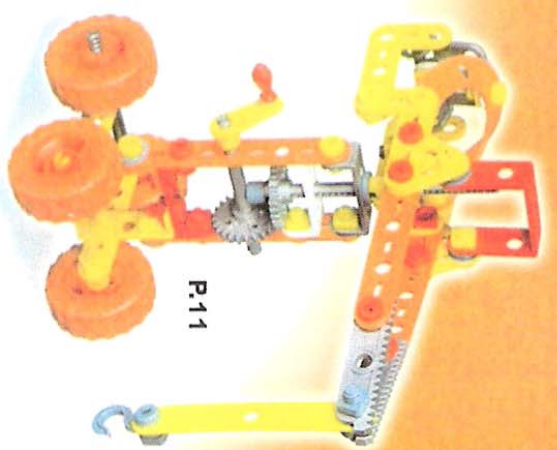

P11



P8

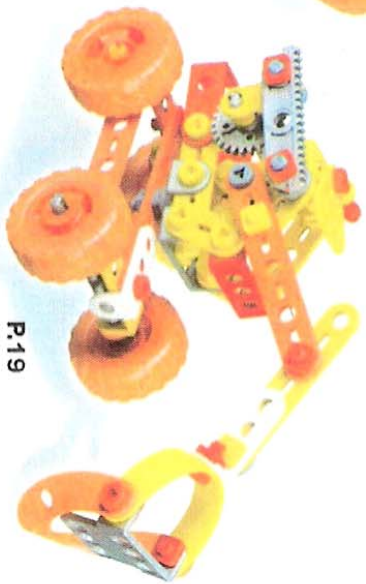

P.19

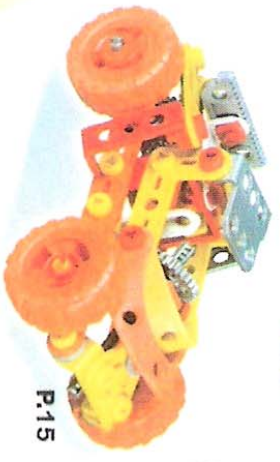

P15

CONSTRUCTION TIPS

LES ASTUCES DE CONSTRUCTION
 KONSTRUKTIONSTIPS
 LE ASTUZZIE DELLA COSTRUZIONE
 LOS INGENIOS DE LA CONSTRUCCION
 DICAS PARA A MONTAGEM
 KOKOONPANON KIKAT
 BYGGKNEPEN
 ET PAR TIPS TIL BYGGEARBEJDET
 DE FINE KNEEPLES VAN NIEF BOUWEN
 TA ÉCUTIVA KÓHTA KATÓAKEUHC
 組み立ての秘訣

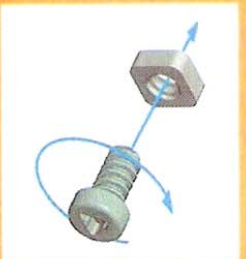

B841 X1

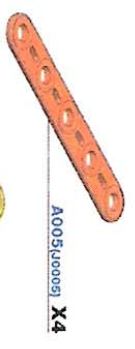

A005 X4



B828 X1

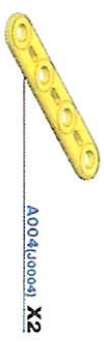

A004 X2



A632 X4



A531 X2



A922 X2



A531 X1



A046 X4



A460 X2



A532 X1



A531 X1

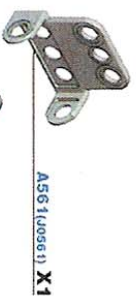

A561 X1



A531 X2



B687 X2



A152 X2



B822 X2

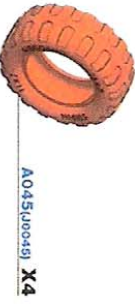

A045 X4

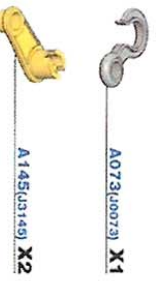

A073 X1



A145 X2



A050 X1



A054 X4

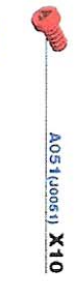

A051 X2



A051 X10



A051 X15



A052 X2



A052 X11



A052 X18



A545 X2



A132 X2



A057 X2



A077 X2

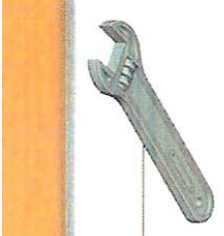

A095 X1



A090 X1

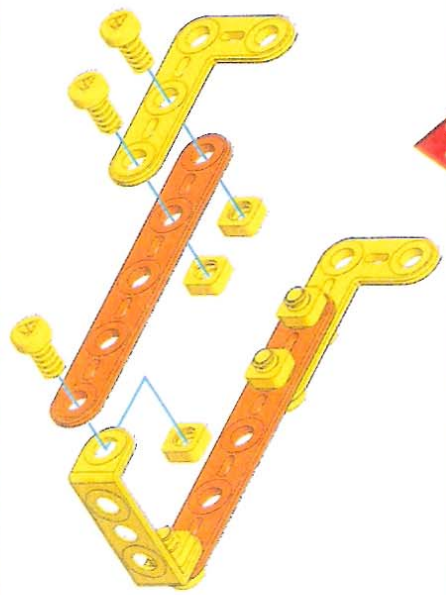
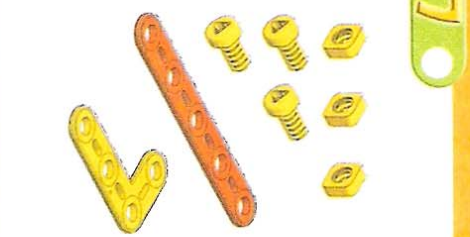
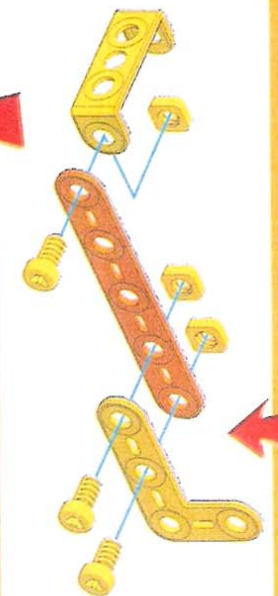
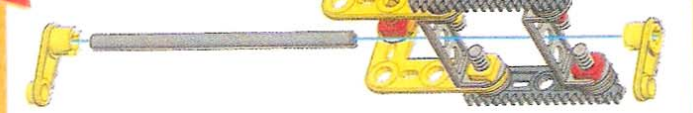
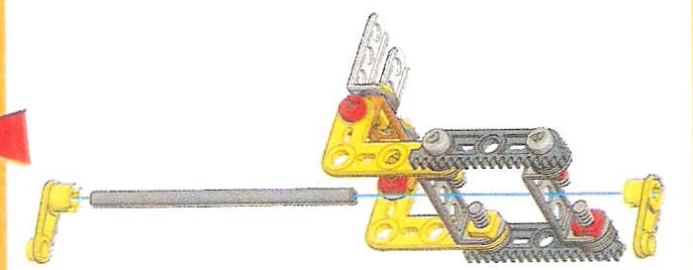
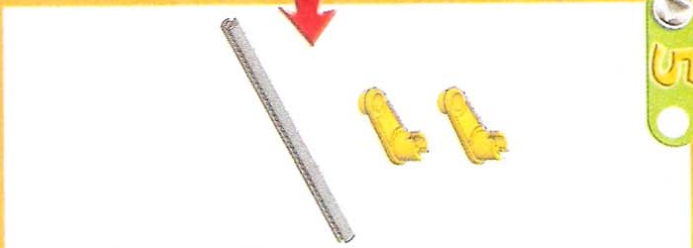
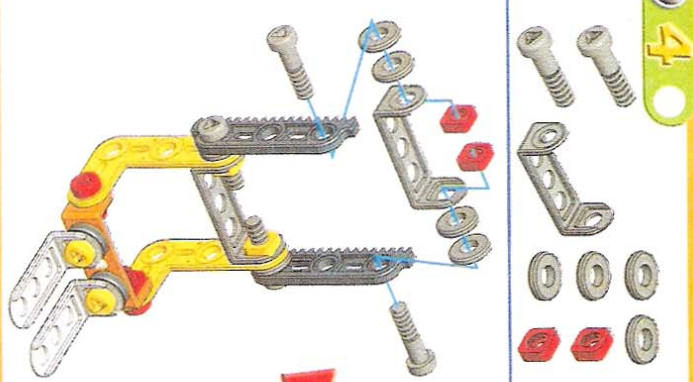
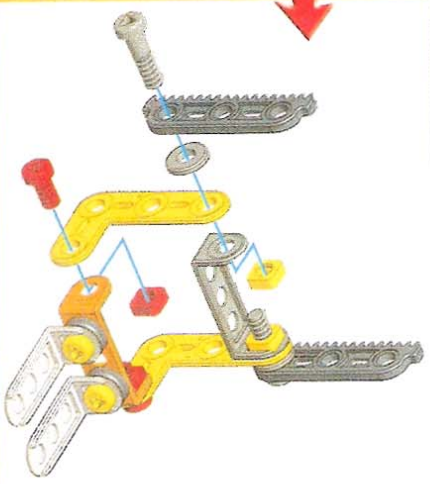
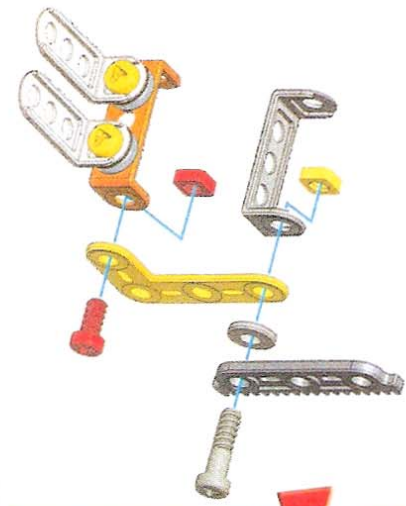
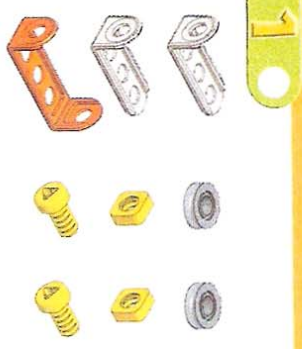
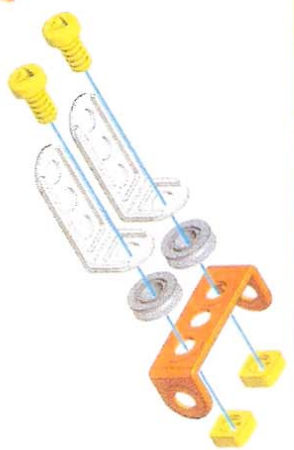

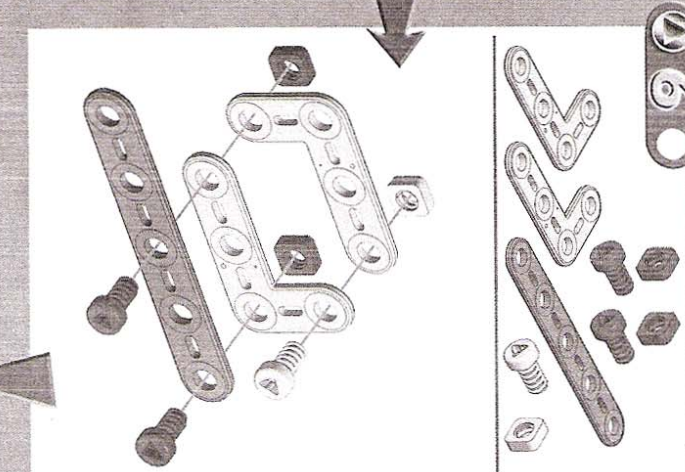
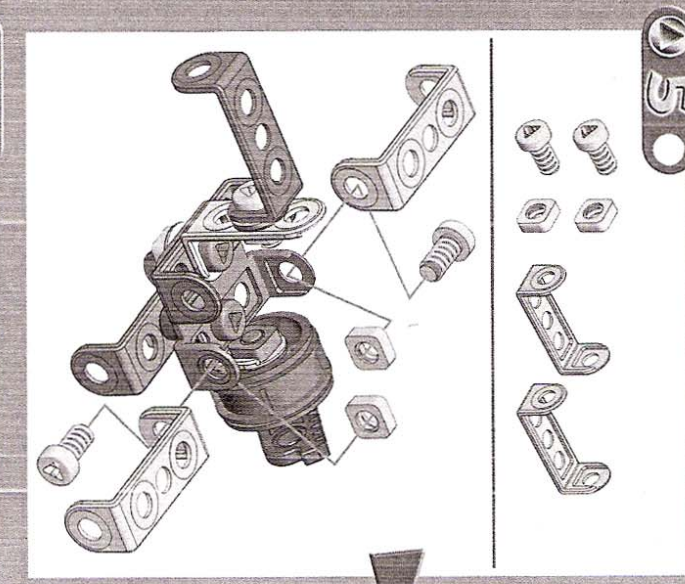
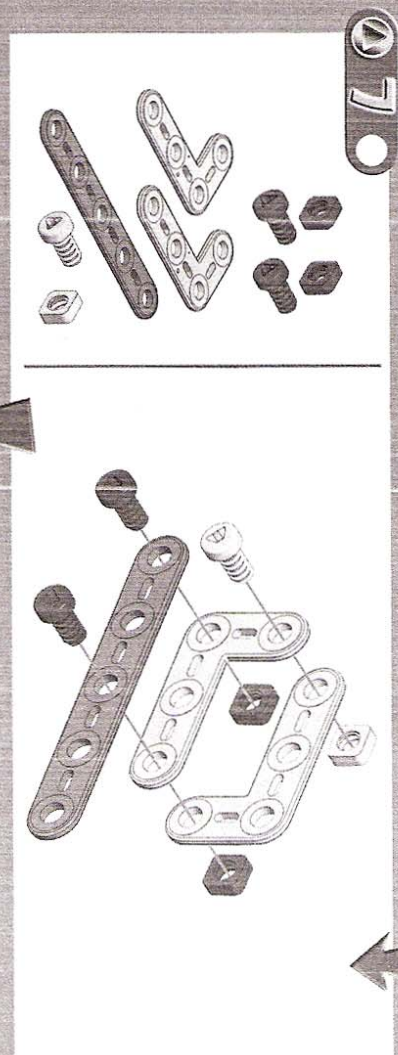
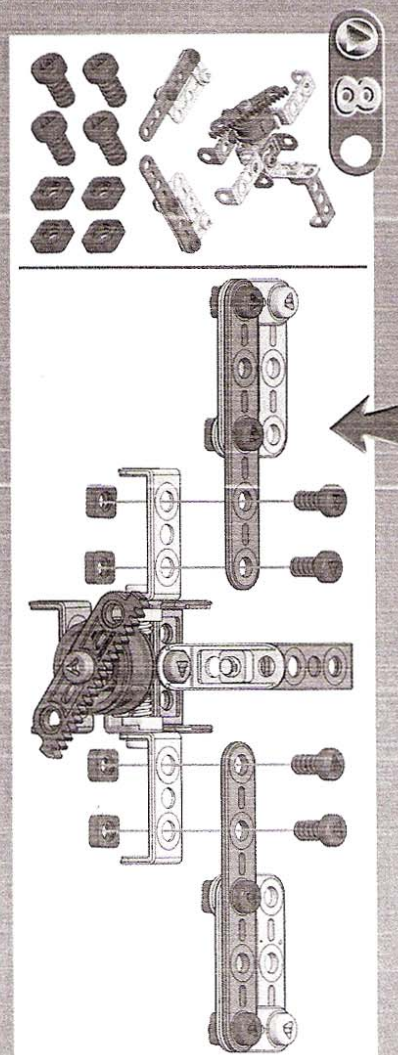
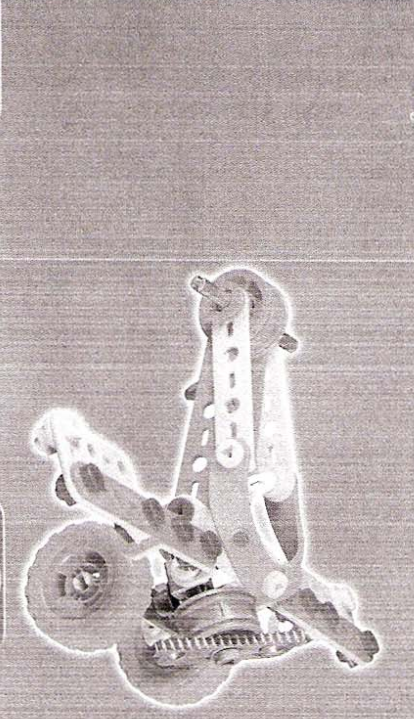
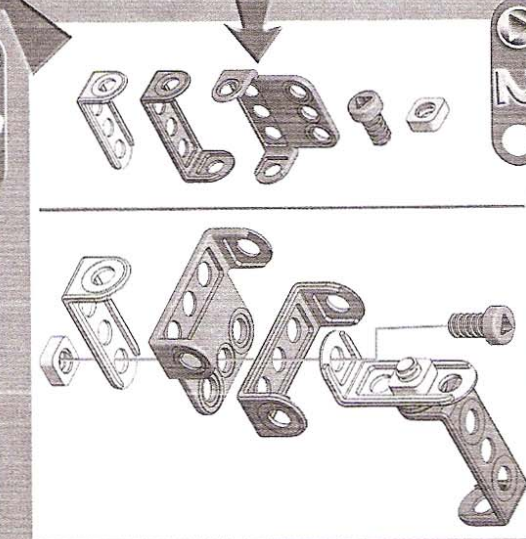
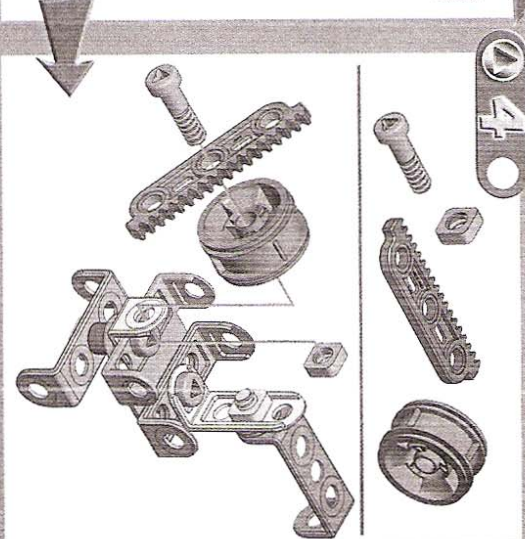
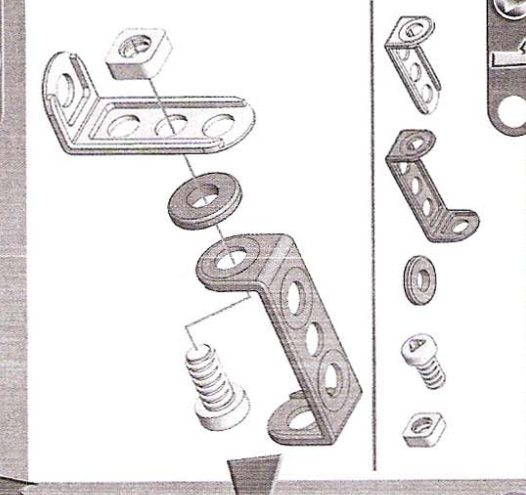
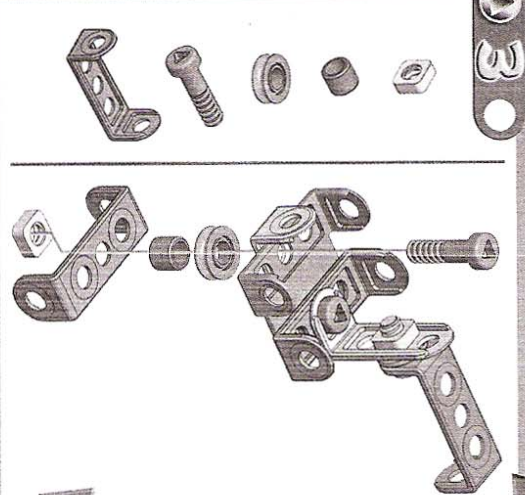

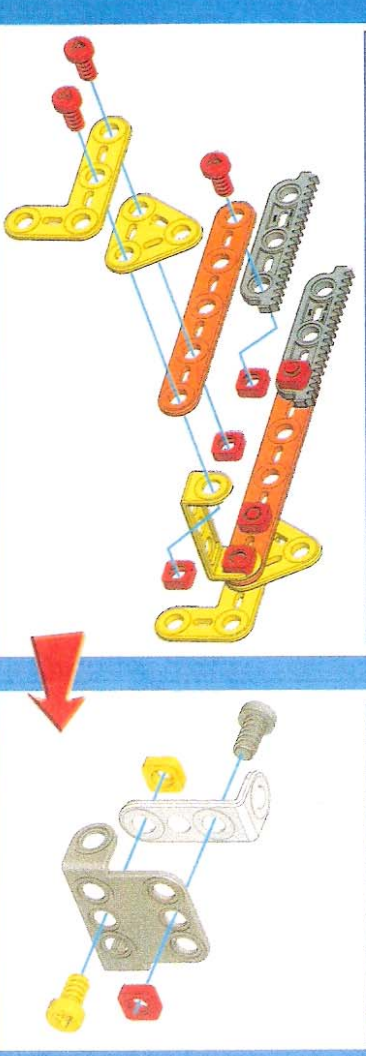
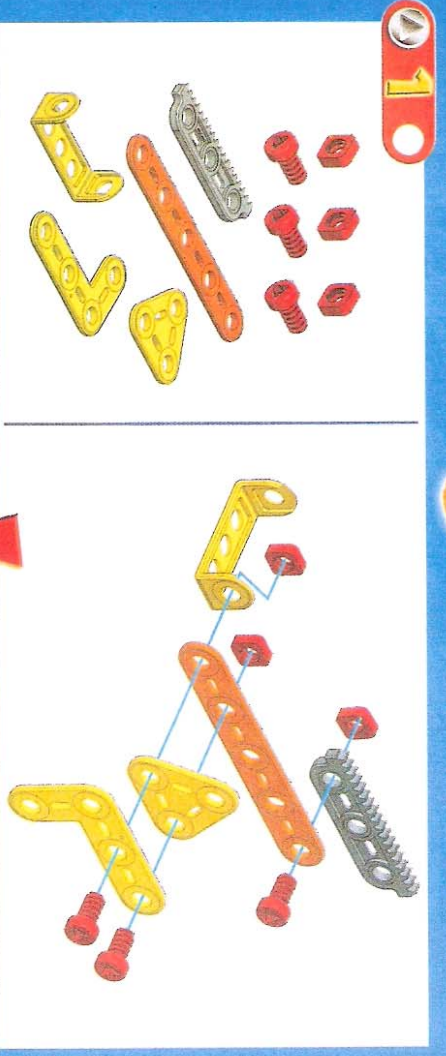
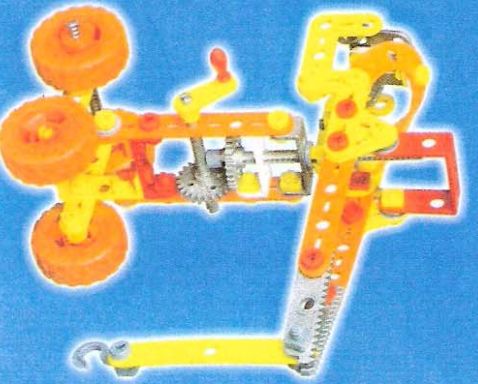
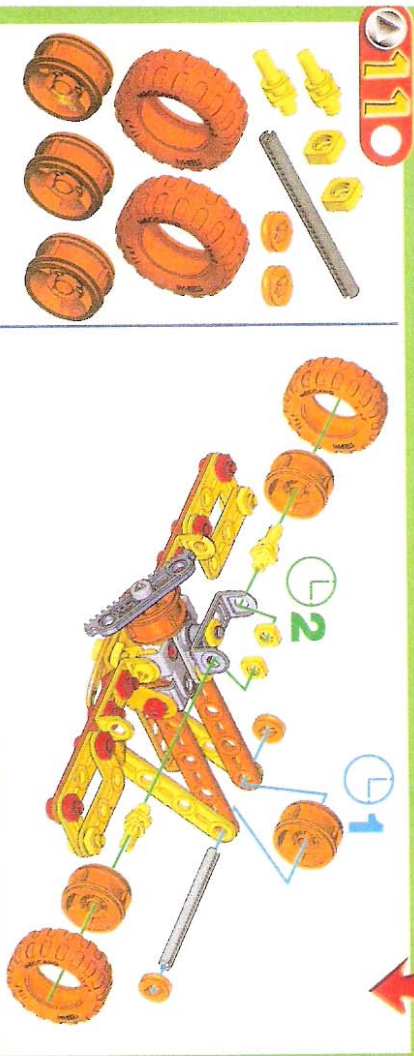
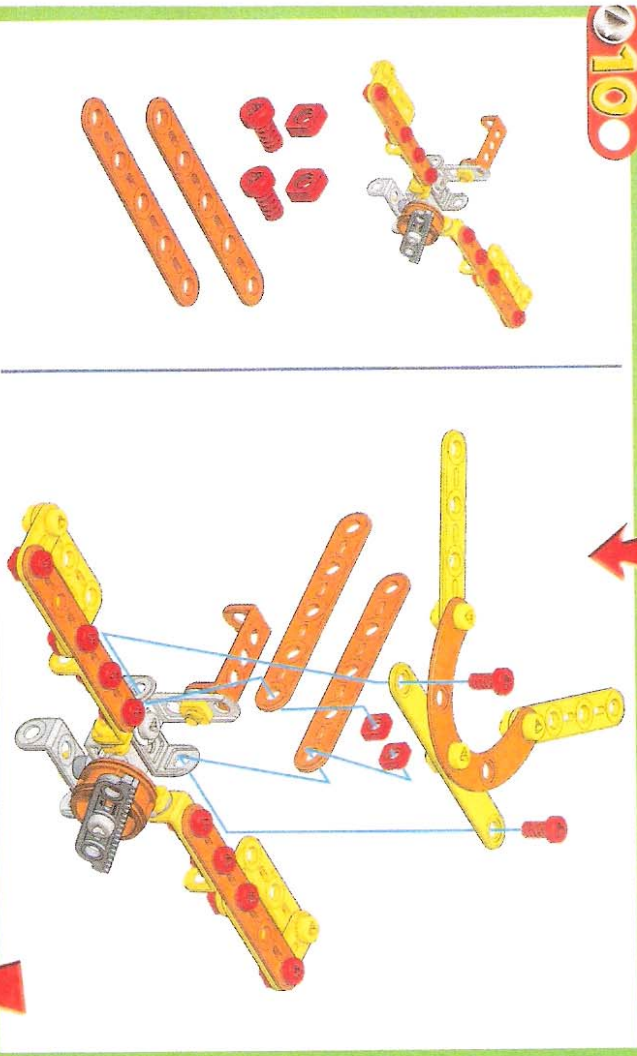
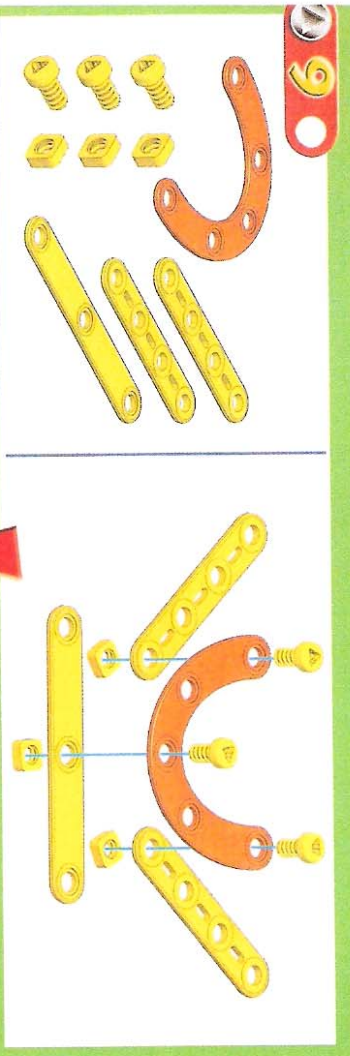

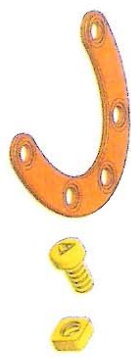

4

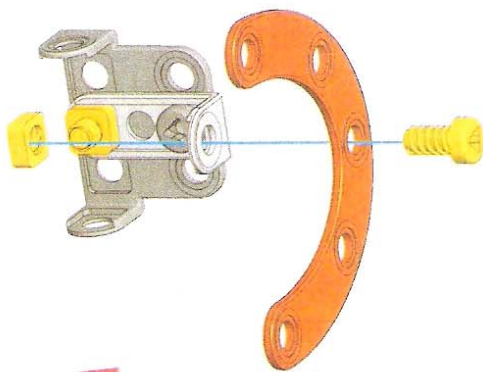

5

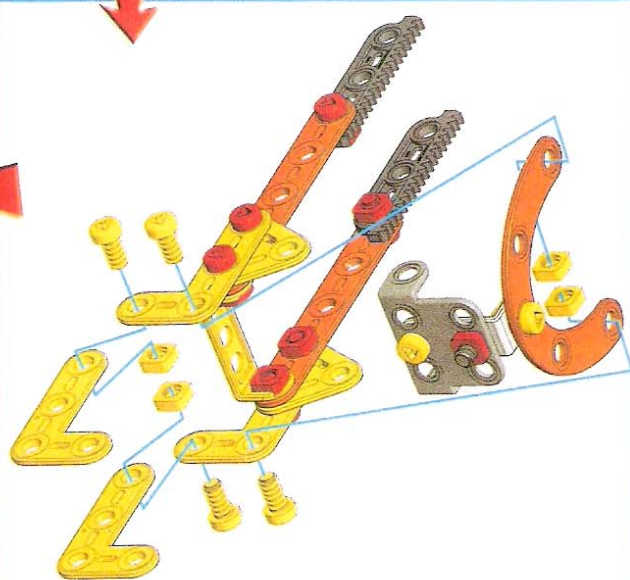

6

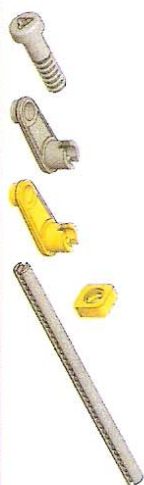
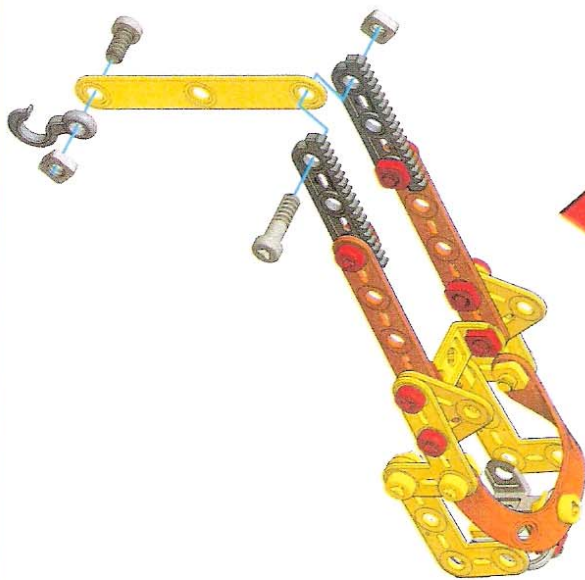

7

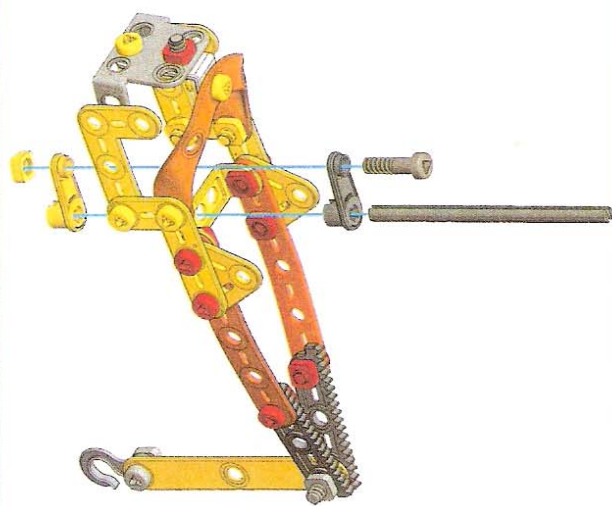

9

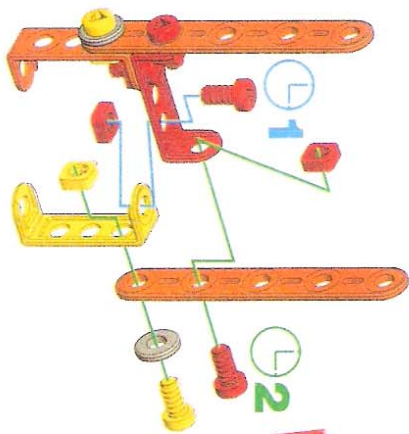

8

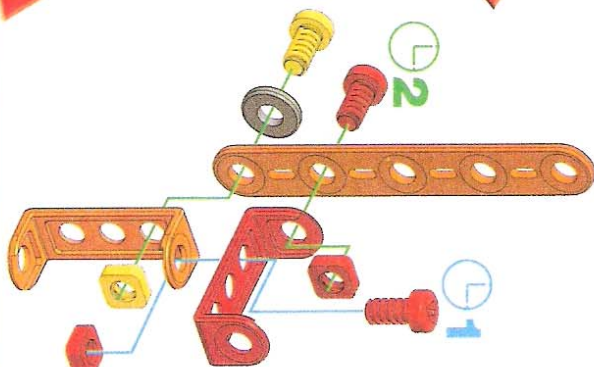

10

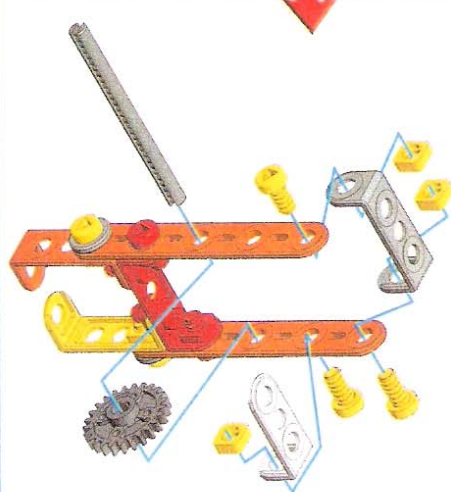



110

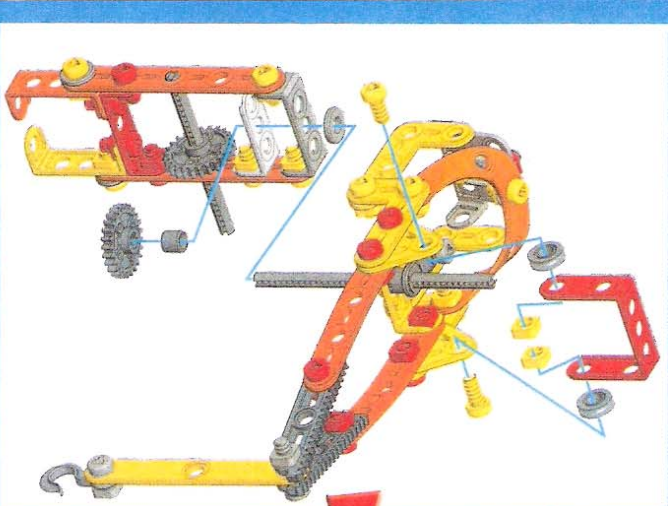

120

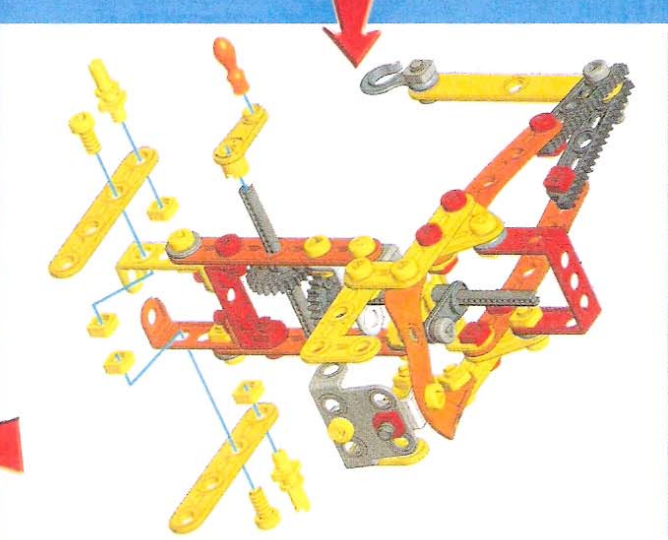

130

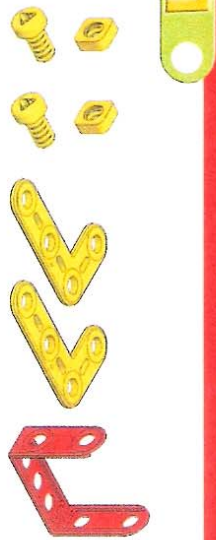
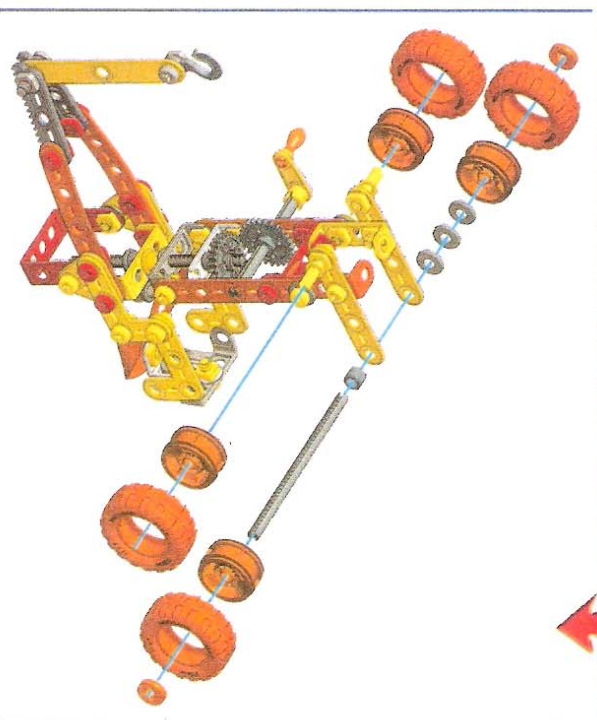

1

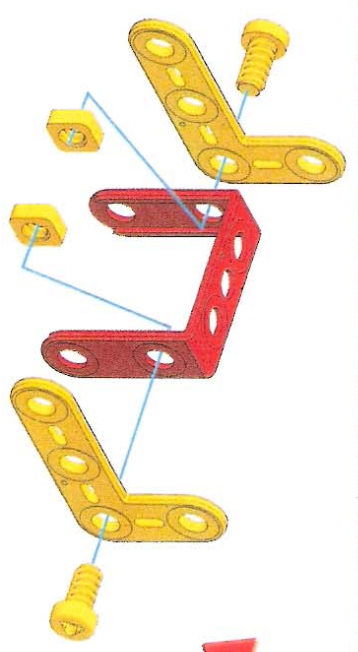

2

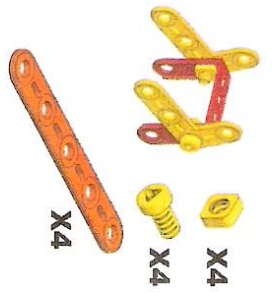
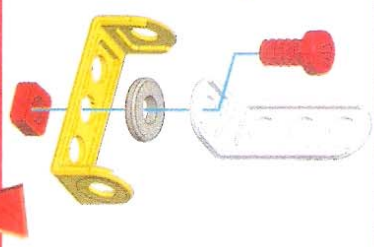

3

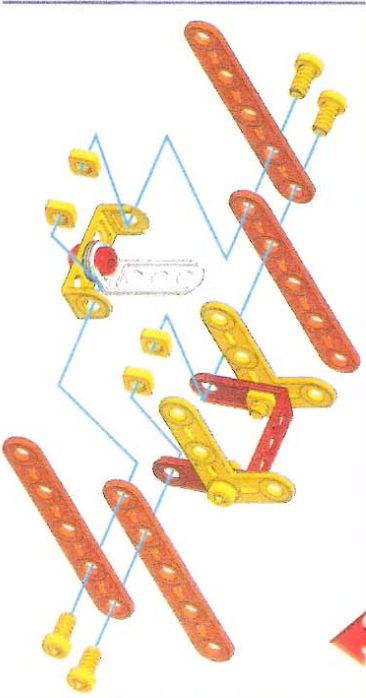

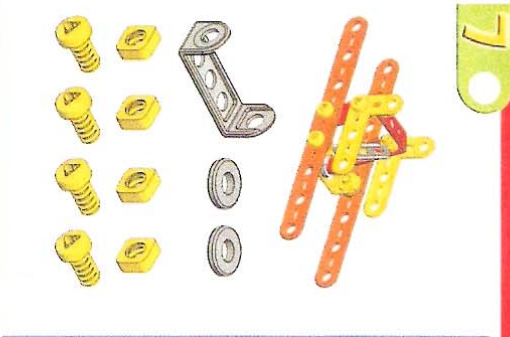

7

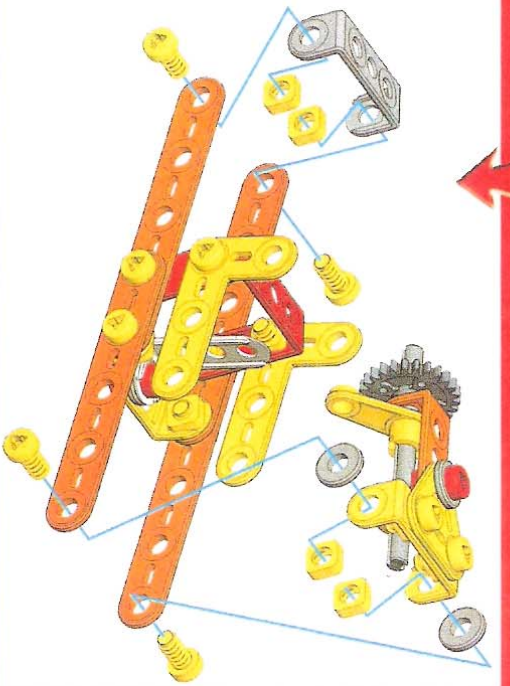

6

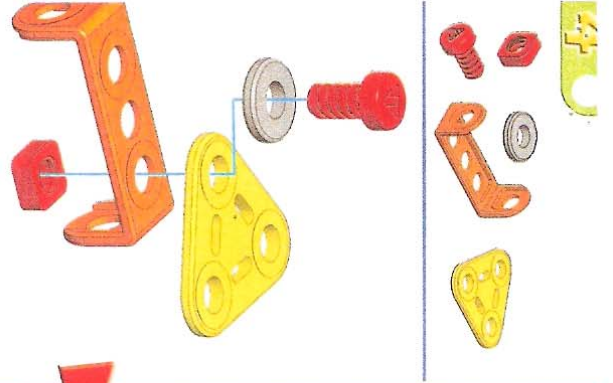
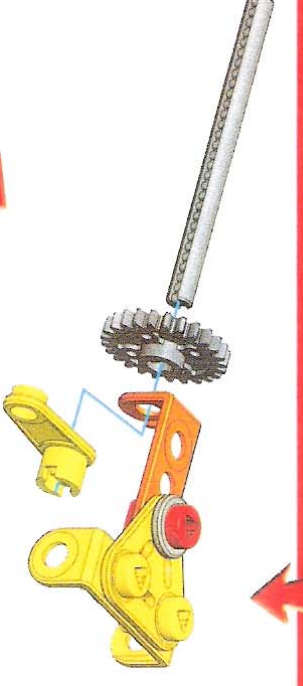

4



5

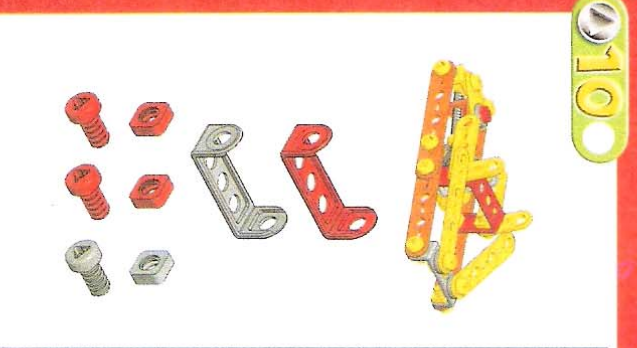
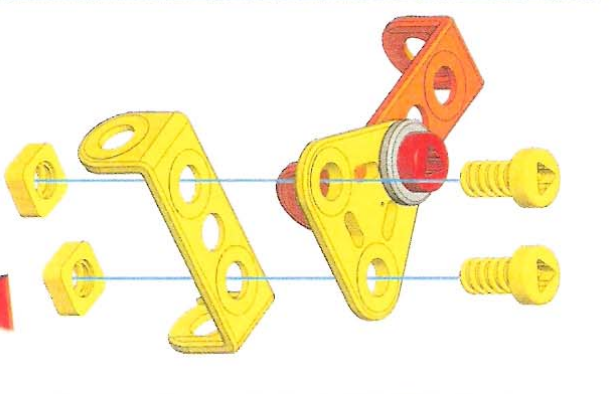

10

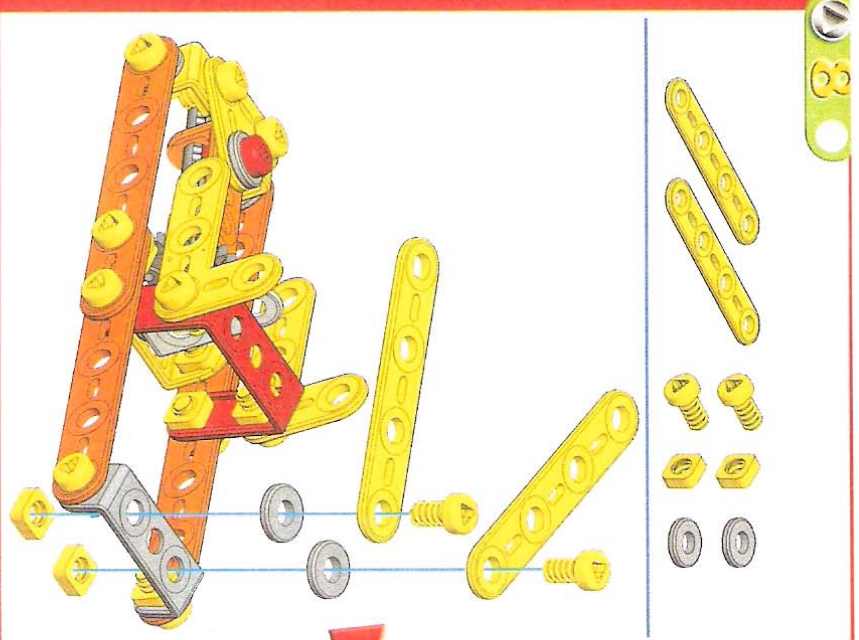
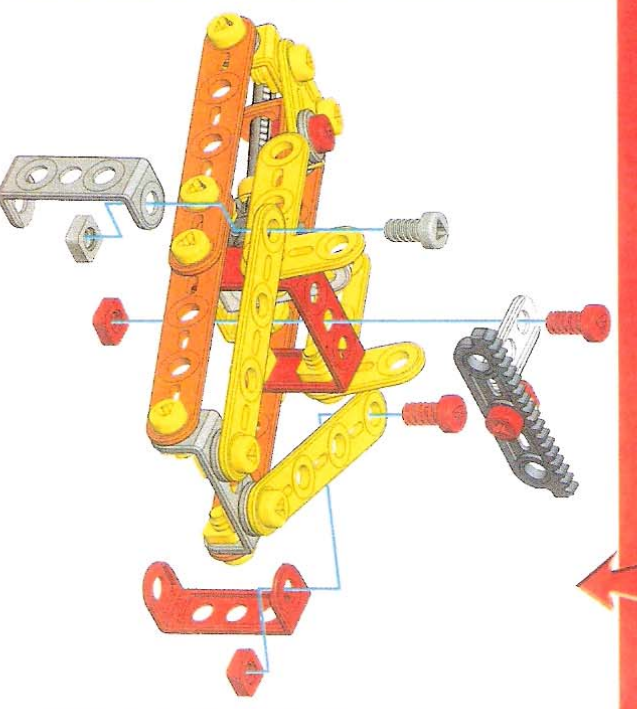

8

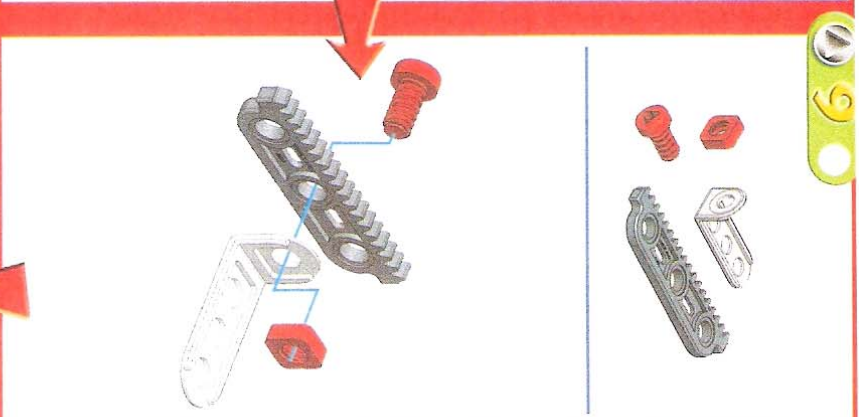

9



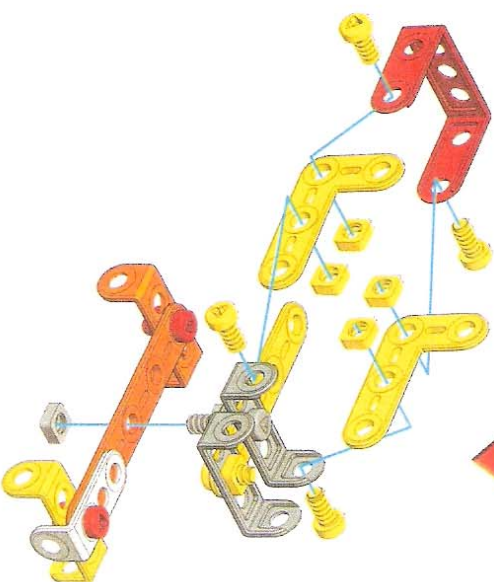
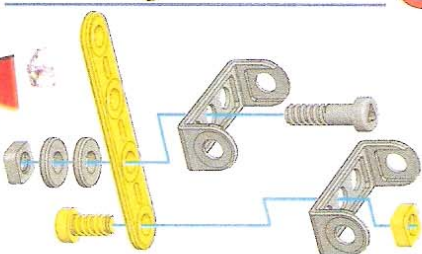
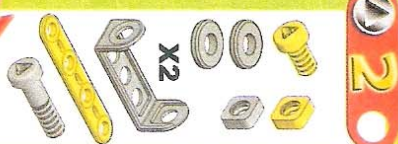
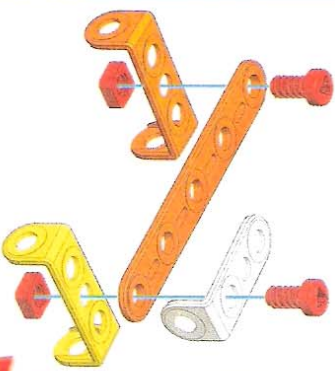
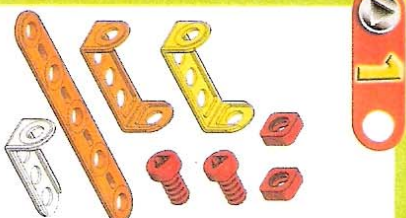
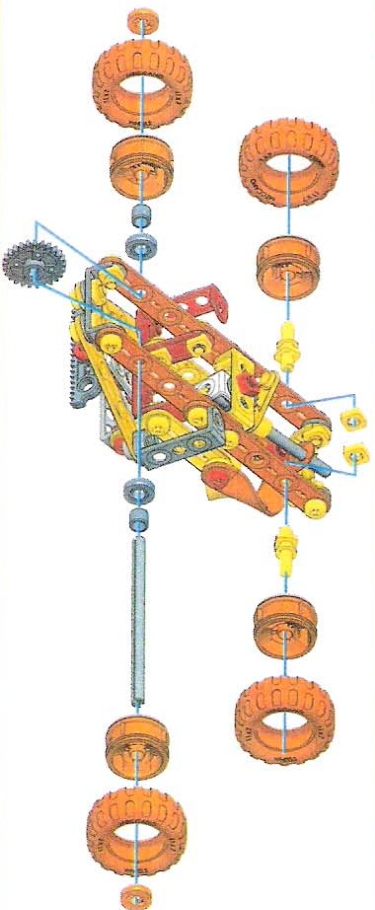
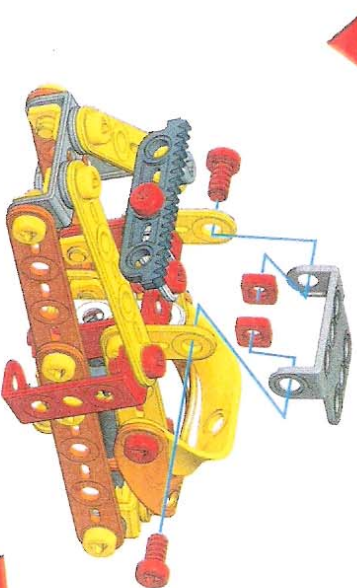
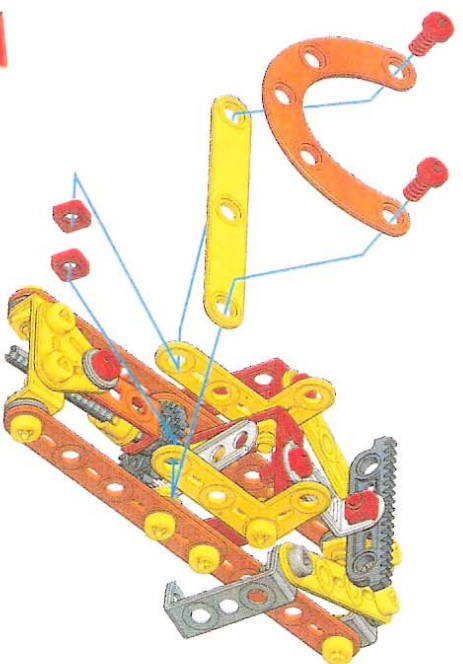

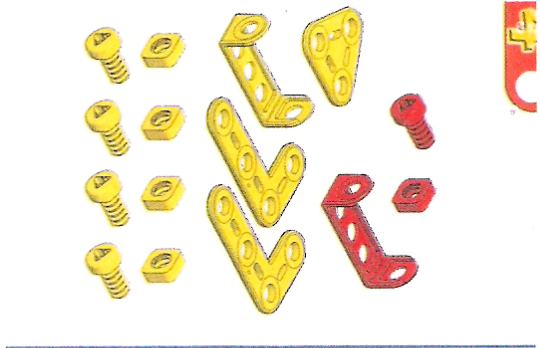

4

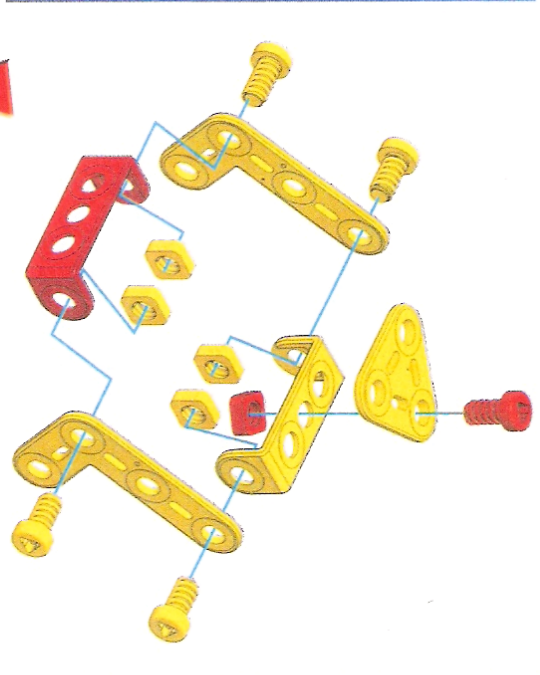

5

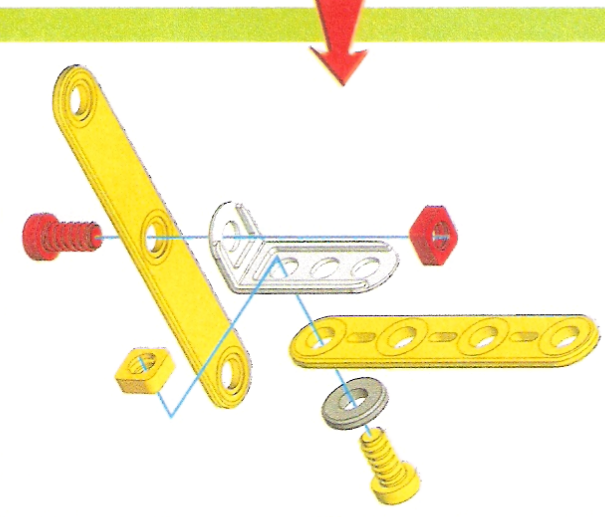
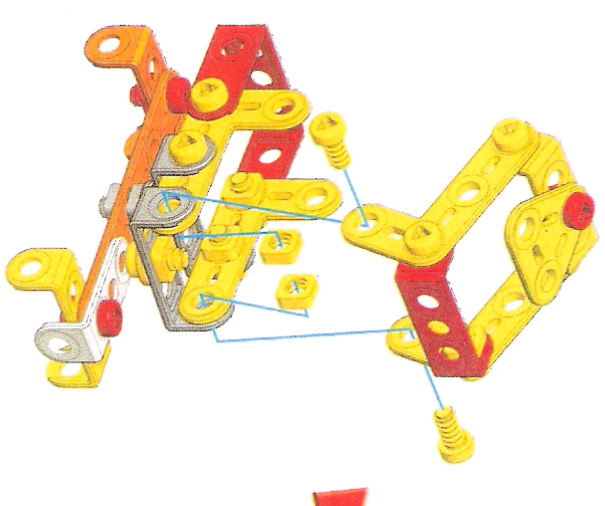
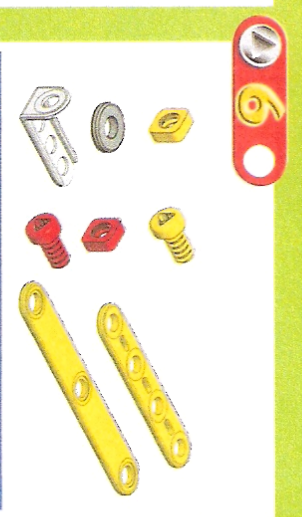

6

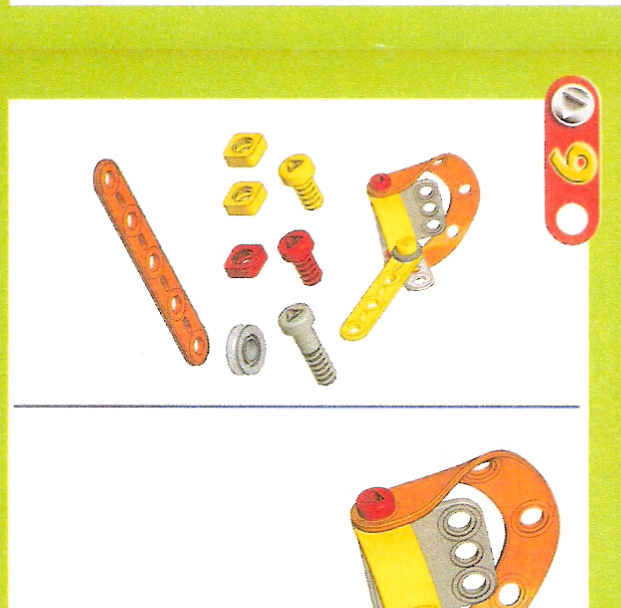

7

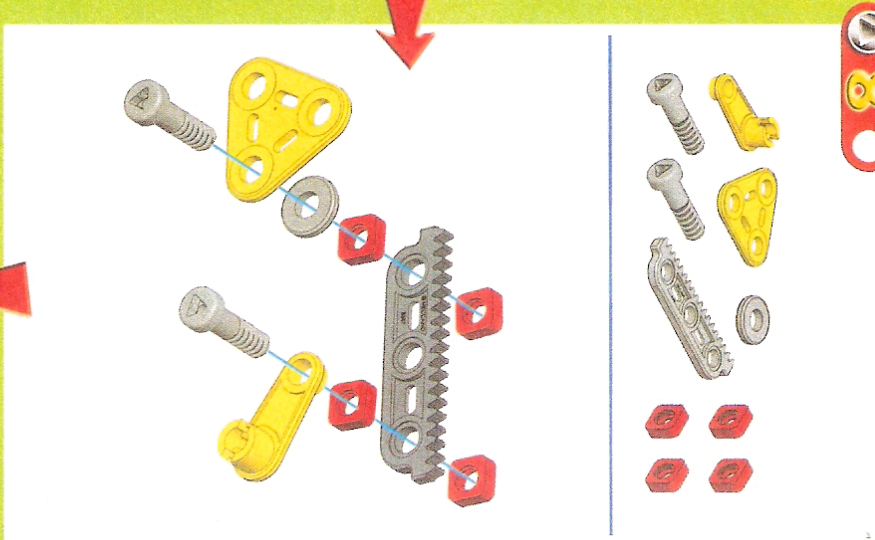
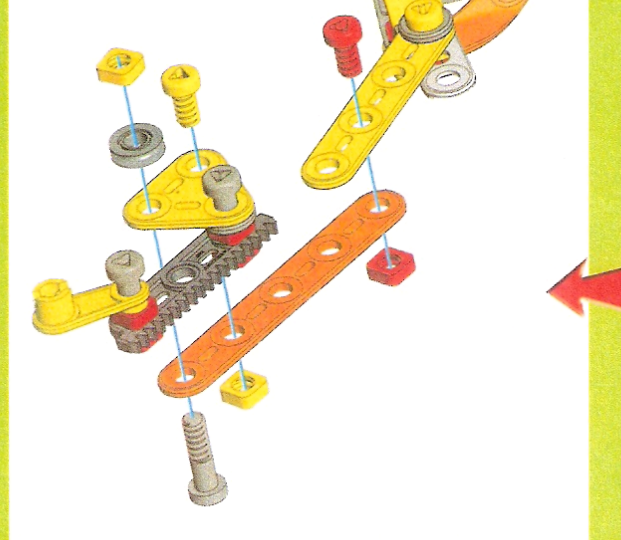
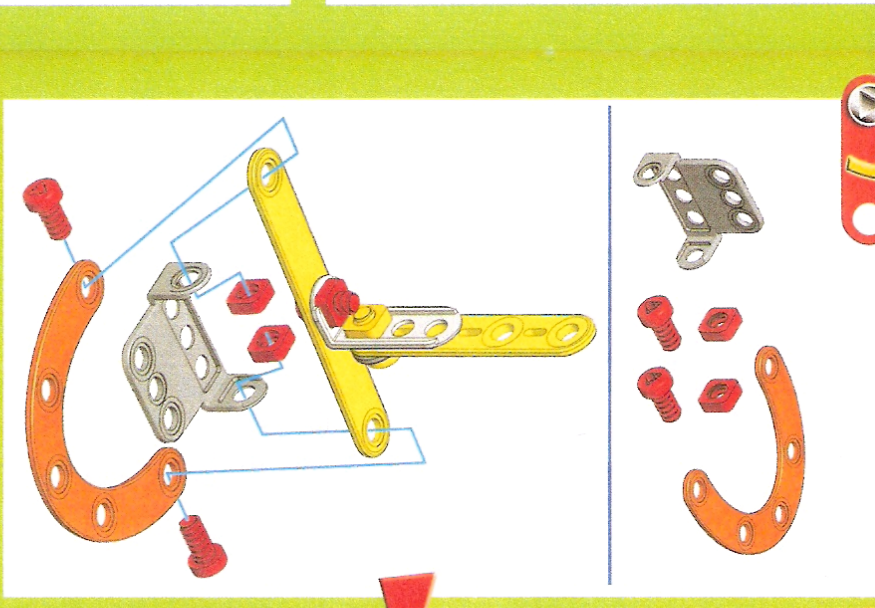

8

