

# **SWITEL**

**COMMUNICATION PRODUCTS**

**Schnurlostelefon**  
**Téléphone sans fil**  
**Telefono senza fili**  
**Cordless telephone**

# **D6026**



**Bedienungsanleitung**  
**Mode d'emploi**  
**Istruzioni per l'uso**  
**Operating Instructions**

# ***SWITEL D6026***

<b>Bedienungsanleitung .....</b>	<b>3</b>
<b>Mode d'emploi .....</b>	<b>23</b>
<b>Istruzioni per l'uso .....</b>	<b>43</b>
<b>Operating Instructions .....</b>	<b>63</b>
<b>Declaration of Conformity .....</b>	<b>84</b>

## - Inhaltsverzeichnis -

<b>1</b>	<b>Allgemeine Hinweise</b> .....	<b>5</b>
1.1	Bestimmungsgemäße Verwendung .....	5
1.2	Stromausfall .....	5
1.3	Aufstellungsort .....	5
1.4	Netzteil .....	5
1.5	Aufladbare Standard-Akkus .....	5
1.6	Laden des Mobilteils .....	5
1.7	Nebenstellenanlagen .....	5
1.8	Hinweise zur Entsorgung .....	5
1.9	Hinweis für medizinische Geräte .....	5
1.10	Temperatur und Umgebungsbedingungen .....	6
1.11	Reinigung und Pflege .....	6
<b>2</b>	<b>Leistungsmerkmale</b> .....	<b>6</b>
2.1	Telefon .....	6
<b>3</b>	<b>Bedienelemente</b> .....	<b>7</b>
3.1	Mobilteil .....	7
3.2	Basisstation .....	7
<b>4</b>	<b>Nebenstellenanlagen / Zusatzdienste</b> .....	<b>8</b>
4.1	R -Taste an Nebenstellenanlagen .....	8
4.2	R -Taste und die Zusatzdienste Ihres Netzbetreibers .....	8
4.3	Wahlpause .....	8
<b>5</b>	<b>Inbetriebnahme</b> .....	<b>9</b>
5.1	Sicherheitshinweise .....	9
5.2	Verpackungsinhalt prüfen .....	9
5.3	Basisstation anschließen .....	9
5.4	Standard-Akkus einsetzen .....	9
5.5	Aufladen der Standard-Akkus .....	9
5.6	Ton (MFV)- oder Impuls (IWV) - Wahlverfahren .....	9
<b>6</b>	<b>Menüstruktur</b> .....	<b>10</b>
<b>7</b>	<b>Bedienung</b> .....	<b>12</b>
7.1	Das Display .....	12
7.2	Externe Anrufbeantworter .....	12
7.3	Anrufe entgegennehmen .....	12
7.4	Zwei Anrufe entgegennehmen .....	12
7.5	Anrufe führen .....	12
7.6	Gespeicherte Rufnummern aus dem Telefonbuch wählen .....	13
7.7	Anzeige der Gesprächsdauer .....	13
7.8	Mobilteil ein-/ausschalten .....	13
7.9	Einstellen der Hörerlautstärke .....	13
7.10	Wahlwiederholung .....	13
7.10.1	Eine Rufnummer aus der Wahlwiederholungslistelöschen .....	13
7.11	Mikrofon im Mobilteil stummschalten .....	13
7.12	Tastensperre ein-/ ausschalten .....	13
7.13	Temporäre Tonwahl .....	13
7.14	Hinweise zur Reichweite .....	13
7.15	Mobilteil suchen (Paging) .....	13
<b>8</b>	<b>Das Telefonbuch</b> .....	<b>14</b>
8.1	Rufnummern in das Telefonbucheingeben .....	14
8.1.1	Hinweise zum Telefonbuch .....	14
8.1.2	Texteingabe .....	14
8.2	Gespeicherte Einträge im Telefonbuch ändern .....	14
8.3	Gespeicherte Einträge aus dem Telefonbuch löschen .....	14

## - Inhaltsverzeichnis -

<b>9</b>	<b>Rufnummernanzeige (CLIP)</b> .....	<b>15</b>
9.1	Die Anruferliste .....	15
9.1.1	Rufnummer aus der Anruferliste wählen .....	15
9.1.2	Rufnummer aus der Anruferliste im Telefonbuch speichern .....	15
9.1.3	Einzelne Rufnummer aus der Anruferliste löschen .....	15
9.1.4	Alle Rufnummern aus der Anruferliste löschen .....	15
<b>10</b>	<b>Sonderfunktionen</b> .....	<b>16</b>
10.1	Basis - Lautstärke einstellen .....	16
10.2	Basis - Melodie einstellen .....	16
10.3	PIN ändern .....	16
10.4	Ton (MFV)- oder Impuls (I WV) - Wahlverfahren .....	16
10.5	Flash-Zeit einstellen .....	16
10.6	Werkseinstellungen wiederherstellen .....	17
10.7	Tastenton und Hinweistöne ein-/ausschalten .....	17
10.8	Mobilteil - Ruftonlautstärke einstellen .....	17
10.9	Mobilteil - Ruftonmelodie einstellen .....	17
10.10	Uhrzeit einstellen .....	18
10.11	Wecker ein/aus .....	18
10.12	Anrufe automatisch entgegennehmen .....	18
10.13	Namen des Mobilteils ändern .....	18
10.14	Sprache einstellen .....	18
<b>11</b>	<b>Mehrere Mobilteile</b> .....	<b>19</b>
11.1	Intern telefonieren .....	19
11.2	Externe Gespräche an ein anderes Mobilteil weiterleiten .....	19
11.3	Konferenzgespräche führen .....	19
11.4	An- und Abmelden von Mobilteilen .....	20
11.4.1	Anmelden von Mobilteilen .....	20
11.4.2	Anmelden von anderen DECT-GAP Telefonen an der Basisstation .....	20
11.4.3	Abmelden von Mobilteilen .....	20
11.5	Zusätzliche Basisstationen .....	20
11.5.1	Wählen einer Basisstation .....	20
<b>12</b>	<b>Fehlerbeseitigung</b> .....	<b>21</b>
<b>13</b>	<b>Wichtige Informationen</b> .....	<b>22</b>
13.1	Technische Daten .....	22
13.2	Garantie .....	22

## **1 Allgemeine Hinweise**

Bitte lesen Sie diese Bedienungsanleitung sorgfältig durch. Öffnen Sie das Gerät in keinem Fall selbst und führen Sie keine eigenen Reparaturversuche durch. Bei Gewährleistungsansprüchen wenden Sie sich bitte an Ihren Fachhändler. Im Zuge von Projektverbesserungen behalten wir uns technische und optische Veränderungen am Artikel vor.

### **1.1 Bestimmungsgemäße Verwendung**

Dieses Telefon ist für den Betrieb an einem analogen Telefonanschluss (PSTN) innerhalb der Schweiz entwickelt worden. Allerdings kann, wegen der Unterschiede zwischen den verschiedenen Telekommunikations-Netzbetreibern, keine Garantie für einwandfreie Funktion an jedem Telekommunikations-Endgeräteanschluss übernommen werden. Schließen Sie das Anschlusskabel des Telefons nur an eine dafür bestimmte Telefonsteckdose an. Wechseln Sie den Stecker des Anschlusskabels nicht aus.

### **1.2 Stromausfall**

Bei Stromausfall kann mit dem Telefon nicht telefoniert werden. Halten Sie für eventuelle Notfälle ein schnurgebundenes Telefon bereit, welches ohne eine externe Stromversorgung arbeitet.

### **1.3 Aufstellungsort**

Der Aufstellungsort hat einen entscheidenden Einfluss auf einen einwandfreien Betrieb des Telefons. Am Aufstellungsort muss sich eine 230 Volt Netzsteckdose befinden.

Stellen Sie die Basisstation nicht in die unmittelbare Umgebung von anderen elektronischen Geräten wie z. B. Mikrowellen oder HIFI-Geräten, da es sonst zu gegenseitiger Beeinflussung kommen kann. Halten Sie einen Abstand von mindestens einem Meter zu elektronischen Geräten ein. Stellen Sie die Basisstation auf eine ebene und rutschfeste Fläche. Normalerweise hinterlassen die FüÙe der Basisstation keine Spuren auf der Aufstellfläche. Wegen der Vielzahl der verwendeten Lacke und Oberflächen kann es jedoch nicht ausgeschlossen werden, dass durch die GerätefüÙe Spuren auf der Abstellfläche entstehen.

### **1.4 Netzteil**

Verwenden Sie nur das mitgelieferte SWITEL Steckernetzteil, da andere Netzteile das Telefon zerstören können. Netzteil nicht öffnen. Es besteht Lebensgefahr, wenn das Netzteil geöffnet wird, solange es an das Stromnetz angeschlossen ist.

### **1.5 Aufladbare Standard-Akkus**

Verwenden Sie die mitgelieferten aufladbaren Standard-Akkus. Verwenden Sie beim Austauschen immer nur Standard-Akkus des Typs AAA 1,2V 550 mAh. Andere Standard-Akkus oder Akkupacks können einen Kurzschluss verursachen. Werfen Sie Standard-Akkus nicht ins Feuer und tauchen Sie sie nicht ins Wasser. Die angegebenen maximalen Standby- und Gesprächszeiten gelten für die mitgelieferten wiederaufladbaren Standard-Akkus bei optimalen Bedingungen. Umgebungstemperatur, Aufladezyklus und weitere äußere Einflussfaktoren, wie z. B. Funkbelastung an der Einsatzumgebung, können die Leistungszeiten erheblich verringern. Die Ladekapazität reduziert sich darüber hinaus technisch bedingt im Verlauf der Nutzung oder durch Lagerung bei sehr hohen oder niedrigen Temperaturen.

### **1.6 Laden des Mobilteils**

Das Mobilteil erwärmt sich beim Laden. Dies ist normal und ungefährlich. Laden Sie das Mobilteil nicht mit fremden Aufladegeräten, da sonst Beschädigungen auftreten können.

### **1.7 Nebenstellenanlagen**

Das Telefon kann auch an einer Nebenstellenanlage angeschlossen werden. Ob Ihr Telefon an Ihrer Nebenstellenanlage einwandfrei funktioniert, erfahren Sie bei dem Händler, bei dem die Nebenstellenanlage gekauft wurde. Es kann **nicht** garantiert werden, dass das Telefon an jeder Nebenstellenanlage funktioniert.

### **1.8 Hinweise zur Entsorgung**

Die Umsetzung europäischen Rechtes in nationale Gesetze und Verordnungen verpflichtet Sie zur sachgerechten Entsorgung von Gebrauchsgütern. Dies dient dem Schutz von Personen und Umwelt.

Das nebenstehende Symbol bedeutet, dass elektrische und elektronische Altgeräte und Batterien getrennt vom Hausmüll zu entsorgen sind.

**Alte oder ausgediente Geräte** entsorgen Sie bei einer Sammelstelle eines geeigneten Entsorgungsträgers.

**Batterien und Akkumulatoren** entsorgen Sie beim batterievertreibenden Handel sowie zuständigen Sammelstellen, die entsprechende Behälter bereitstellen.

**Verpackungsmaterialien** entsorgen Sie entsprechend den lokalen Vorschriften.

### **1.9 Hinweis für medizinische Geräte**

Das Telefon arbeitet mit einer sehr geringen Sendeleistung. Diese geringe Sendeleistung schließt eine gesundheitliche Gefährdung nach dem derzeitigen Stand von Forschung und Technik aus. Es hat sich aber gezeigt, dass eingeschaltete tragbare Telefone medizinische Geräte beeinflussen können. Benutzen Sie das Telefon deshalb nicht in der Nähe von medizinischen Geräten. Eine Beeinflussung von Herzschrittmachern durch DECT-Telefone ist bisher nicht beobachtet worden, kann jedoch nicht völlig ausgeschlossen werden. DECT-Telefone können in Hörgeräten einen unangenehmen Brummtönen verursachen.



## - Allgemeine Hinweise -

### 1.10 Temperatur und Umgebungsbedingungen

Das Telefon ist für den Betrieb in geschützten Räumen mit einem Temperaturbereich von 10 °C bis 30 °C ausgelegt. Die Basisstation darf nicht in Feuchträumen wie Bad oder Waschküche aufgestellt werden. Vermeiden Sie die Nähe zu Wärmequellen wie Heizkörpern und setzen Sie das Gerät keiner direkten Sonnenbestrahlung aus.

Verwenden Sie das Mobilteil nicht in explosionsgefährdeten Bereichen.

Vermeiden Sie Belastungen durch Rauch, Staub, Erschütterungen, Chemikalien, Feuchtigkeit, Hitze oder direkte Sonneneinstrahlung.

### 1.11 Reinigung und Pflege

Reinigen Sie die Gehäuseoberflächen mit einem trockenen, weichen und fusselreifen Tuch. Verwenden Sie keine Reinigungsmittel oder aggressiven Lösungsmittel. Außer einer gelegentlichen Gehäusereinigung ist keine weitere Pflege erforderlich. Die Gummifüße der Basisstation sind nicht gegen alle Reinigungsmittel beständig. Der Hersteller kann daher nicht für evtl. Schäden an Möbeln o. Ä. haftbar gemacht werden.

## - Leistungsmerkmale -

## 2 Leistungsmerkmale

### 2.1 Telefon

- Digitaler DECT/GAP Standard
- Bis zu 10 Stunden Dauergespräch - bis zu 110 Stunden Stand-by
- Sprachverschlüsselung für hohe Sicherheit
- Tonwahl/Pulswahl (MFV/IWV)
- Rufnummernanzeige im Display (CLIP)
- Anruferliste für bis zu 40 Rufnummern
- Wahlwiederholung der letzten 10 Rufnummern
- Telefonbuch für bis zu 50 Rufnummern inklusive Namen
- 24-Stunden-Uhr mit Weck-/Alarmfunktion im Mobilteil integriert
- Anzeige der Gesprächsdauer
- Durch weitere GAP-fähige DECT-Mobilteile erweiterbar
- Multilinkbetrieb mit bis zu fünf Mobilteilen
- Kostenlose interne Gespräche zwischen zwei Mobilteilen möglich
- Konferenzgespräche zwischen zwei Mobilteilen und einem externen Teilnehmer
- Weiterleiten von Gesprächen zwischen den Mobilteilen
- Mehrfach einstellbare Tonrufmelodie für das Mobilteil und die Basisstation
- VIP-Ruf (Melodien-Zuordnung)
- Geeignet für Zusatzdienste Ihres Netzbetreibers (Hook-Flash) - Nebenstellentauglich
- Mikrofonstummschaltung
- Tastatursperre

DECT: **D**igital **E**uropean **C**ordless **T**elephone = Standard für kabellose Telefone.

GAP: **G**eneric **A**ccess **P**rofile = Standard für das Zusammenwirken von Mobilteilen und Basisstationen anderer Hersteller.

### 3 Bedienelemente

#### 3.1 Mobilteil

1. Gesprächsanzeige
2. Wahlwiederholung
3. Menü
4. Telefonbuch
5. Auswahltasten / Anruferliste CLIP
6. Interne und Konferenzgespräche
7. R-Signaltaste / Ein / Aus
8. Gesprächstaste
9. Stumm / Löschtaste

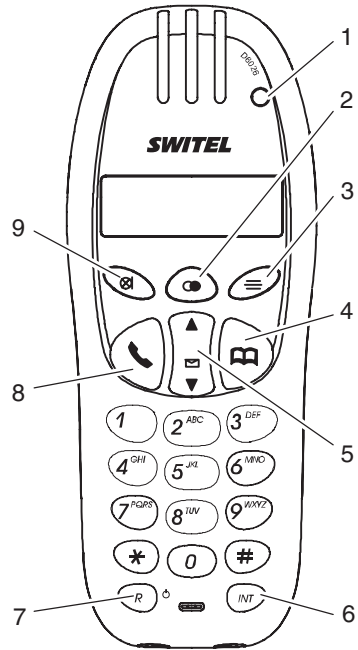

#### 3.2 Basisstation

10. Paging-Taste (Mobilteil suchen)
11. LED Gesprächs- und Netzanzeige
12. LED Ladekontrollleuchte

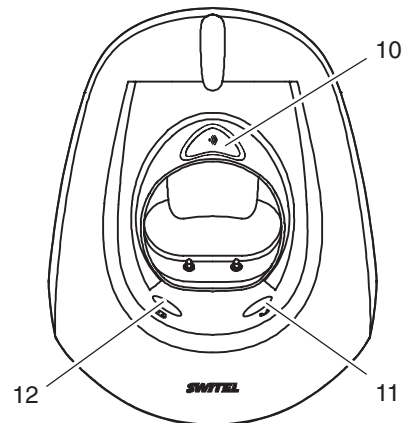

## **4 Nebenstellenanlagen / Zusatzdienste**

Die Taste  R Ihres Telefons können Sie an Nebenstellenanlagen und bei der Verwendung von Zusatzdiensten Ihres Netzbetreibers nutzen.

### **4.1 R -Taste an Nebenstellenanlagen**

Ist Ihr Telefon über eine Nebenstellenanlage angeschlossen, können Sie über die Taste  R alle Möglichkeiten, wie z. B. Anrufe weiterleiten, automatischen Rückruf usw., nutzen. An einer Nebenstellenanlage wird eine Flash-Zeit von 100 ms benötigt (Einstellung siehe Kapitel 10.5). Ob Ihr Telefon an Ihrer Nebenstellenanlage einwandfrei funktioniert, erfahren Sie bei dem Händler, bei dem die Anlage gekauft wurde.

### **4.2 R -Taste und die Zusatzdienste Ihres Netzbetreibers**

Ihr SWITEL-Telefon unterstützt die wichtigsten Zusatzdienste Ihres Netzbetreibers (z. B. MakeIn, Anklopfen, Dreier-Konferenz). Zur Nutzung von Mehrwertdiensten Ihres Netzbetreibers müssen Sie die Flash-Zeit auf 100 ms einstellen (Einstellung siehe Kapitel 10.5). Zur Freischaltung der Zusatzdienste wenden Sie sich bitte an Ihren Netzbetreiber.

### **4.3 Wahlpause**

Bei Nebenstellenanlagen ist es erforderlich, eine bestimmte Nummer zu wählen (z. B. "9" oder "0"), um ein Freizeichen für eine Amtsleitung zu bekommen. Bei wenigen, älteren Nebenstellenanlagen dauert es einige Zeit, bis das Freizeichen zu hören ist. Speziell für diese Nebenstellenanlagen kann nach der Amtsholung eine automatische Pause eingefügt werden, so dass Sie direkt weiter wählen können, ohne das Freizeichen abzuwarten.

Drücken Sie zwischen der Amtskennziffer und der Rufnummer einmal die Taste  ● . Im Display erscheint die Anzeige "P". Nach der Amtsholung wartet Ihr Telefon für 3 Sekunden mit dem Wählen der eigentlichen Rufnummer.

**Hinweis:** Die Pause kann auch bei der Eingabe von Rufnummern in das Telefonbuch eingegeben werden.



## - Inbetriebnahme -

### 5 Inbetriebnahme

#### 5.1 Sicherheitshinweise



**Achtung:** Lesen Sie vor der Inbetriebnahme unbedingt die allgemeinen Hinweise am Anfang dieser Bedienungsanleitung.

#### 5.2 Verpackungsinhalt prüfen

Zum Lieferumfang gehören:

eine Basisstation	ein Telefonanschlusskabel
ein Mobilteil	zwei Standard-Akkus
ein Netzteil	eine Bedienungsanleitung

#### 5.3 Basisstation anschließen

Stellen Sie die Basisstation in der Nähe Ihrer Telefonanschlussdose und einer Netzsteckdose auf. Verwenden sie nur die mitgelieferten Komponenten.

1. Stecken Sie den kleinen Stecker des Netzteils in die entsprechende Buchse auf der Unterseite der Basisstation.

**Hinweis:** Sie können die Stecker nicht falsch anschließen, weil Stecker und Buchsen konstruktiv gegen eine Verpolung geschützt sind. Die Stecker müssen hörbar in die Buchsen an der Basisstation einrasten.

2. Stecken Sie den kleinen Stecker des Telefonanschlusskabels in die entsprechende Buchse auf der Unterseite der Basisstation.
3. Führen Sie beide Kabel auf der Unterseite der Basisstation im vorgesehenen Kabelkanal zur Rückseite.
4. Stecken Sie das Netzteil in eine vorschriftsmäßig installierte 230 Volt Netzsteckdose. Das Netzteil der Basisstation muss immer angeschlossen sein.
5. Verbinden Sie das beiliegende Telefonanschlusskabel mit der Telefonsteckdose.

#### 5.4 Standard-Akkuseinsetzen

Um die mitgelieferten wiederaufladbaren Standard-Akkus in das Mobilteil einzulegen, drücken Sie auf den Batteriefachdeckel am oberen Rand und schieben Sie ihn nach unten. Legen Sie nun die Standard-Akkus ein. Achten Sie dabei auf die richtige Polung. Schließen Sie das Batteriefach.

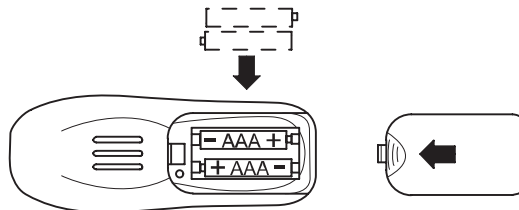

#### 5.5 Aufladen der Standard-Akkus

Stellen Sie das Mobilteil mit dem Display nach vorne für mindestens 14 Stunden auf die Basisstation. An der Basisstation leuchtet die Ladekontrollleuchte. Bei nicht richtig geladenen Standard-Akkus kann es zu Fehlfunktionen des Telefons kommen.

Die wiederaufladbaren Standard-Akkus Ihres Mobilteils besitzen eine Standby-Zeit bei Zimmertemperatur von max. 110 Stunden. Die maximale Gesprächsdauer beträgt 10 Stunden.

Der aktuelle Akkuladezustand wird im Display angezeigt:

Voll	Halb	Schwach	Leer

#### 5.6 Ton (MFV)- oder Impuls (IWV) - Wahlverfahren

Dieses Merkmal ermöglicht Ihnen, Ihr Telefon sowohl an den analogen Anschlüssen (Impuls-Wahl/IWV) als auch an den digitalen Anschlüssen (Ton-Wahl/MFV) zu betreiben. Das Gerät ist werkseitig auf das Ton-Wahlverfahren (MFV) eingestellt. Sollte Ihr Telefon nicht an Ihrem Anschluss funktionieren, erfahren Sie im Kapitel 10.4 wie Sie Ihr Telefon auf das Impuls-Wahlverfahren (IWV) umstellen können.

## - Menüstruktur -

### 6 Menüstruktur

Hier finden Sie die Menüstruktur Ihres Telefons. Im Stand-by öffnen Sie die Menüauswahl durch Drücken der Taste .

Telefonbuch	Hinzufuegen	Name ?	Nummer ?	Melodie 1-5
	Aendern			
	Loeschen			

Einstellung	Basis-Lautst	Lautstaerke 1, 2, 3, 4, 5, Ton aus		
	Basis-Melody	Melodie 1, 2, 3, 4, 5		
	MT-abmelden	PIN ? (Werkseinstellung 0000)		
	PIN Code	PIN ? (Werkseinstellung 0000)	PIN neu	Wiederh PIN
	MFV-IWV	MFV		
		IWV		
	Flashzeit	Flash 1		
		Flash 2		
	Werkseinst	PIN ? (Werkseinstellung 0000)	Bestaetigen ?	

**- Menüstruktur -**











Mobilteil	Toene	Tastenton	Ein - Aus
		Akku Leer	Ein - Aus
		Reichweite	Ein - Aus
	Int Ruf Laut	Lautstaerke 1, 2, 3, 4, 5, Ton aus	
	Ext Ruf Laut	Lautstaerke 1, 2, 3, 4, 5, Ton aus	
	Int Melodie	Melodie 1, 2, 3, 4, 5	
	Ext Melodie	Melodie 1, 2, 3, 4, 5	
	Uhr einst	Aktuelle Uhrzeit	
	Wecker eins	Ein - Aus	Weckzeit
	Auto Annahme	Ein - Aus	
	Name	.....	
	Sprache	Deutsch	
		English	
		Francais	
	Tastensperre	Italiano	

Anmelden	Basis-Wahl	BS 1 _ _ _
		Auto
	Basis Anmeld	BS 1 2 3 4



## - Bedienung -

### 7 Bedienung

#### 7.1 Das Display

Display	Beschreibung
	<b>Konstant:</b> Sie führen ein Gespräch.
EXT	<b>Konstant:</b> Sie führen ein externes Gespräch. <b>Blinkt:</b> Es erreicht Sie ein externer Anruf.
	<b>Konstant:</b> Sie führen ein internes Gespräch. <b>Blinkt:</b> Es erreicht Sie ein interner Anruf.
	<b>Konstant:</b> Sie befinden sich in der Anruferliste. <b>Blinkt:</b> Es sind neue Anrufe in der Anruferliste.
	<b>Konstant:</b> Diese Rufnummer der Anruferliste wurde nicht entgegengenommen.
	<b>Konstant:</b> Diese Rufnummer der Anruferliste wurde entgegengenommen.
	<b>Blinkt:</b> Akkus aufladen. <b>Konstant:</b> Anzeige der Batteriekapazität. <b>Durchlaufen der Segmente:</b> Die Akkus werden geladen.
	<b>Konstant:</b> Sie befinden sich im Telefonbuch.
	<b>Konstant:</b> Die Programmierung ist aktiviert.
	<b>Konstant:</b> Die Tastatursperre ist aktiviert.
	<b>Konstant:</b> Die Verbindung zur Basisstation ist gut. <b>Blinkt:</b> Die Reichweite der Basisstation ist überschritten.
	<b>Konstant:</b> Die Rufnummer ist länger als 12 Ziffern.

#### 7.2 Externe Anrufbeantworter

Das Symbol  signalisiert Ihnen neue Nachrichten auf Ihrem externen Anrufbeantworter. Das Anzeigen des Symbols  ist nur mit einem digitalen Telefonanschluss möglich. Nach Abhören der Nachrichten erlischt das Symbol.



**Achtung:** Der externe Anrufbeantworter und die Übermittlung des Symbols  ist ein optionaler Service Ihres Netzbetreibers. Bitte fragen Sie Ihren Netzbetreiber nach weiteren Informationen.

#### 7.3 Anrufeentgegennahmen

Bei eingehendem Anruf ertönt der Tonruf am Mobilteil und an der Basisstation. Nehmen Sie das Mobilteil von der Basisstation oder drücken Sie die Gesprächstaste . Die Verbindung wird hergestellt.

Zum Beenden des Gespräches stellen Sie das Mobilteil zurück in die Basisstation oder drücken Sie die Taste .

**Hinweis:** Klingelt das Mobilteil, verändern Sie durch Drücken der Tasten  oder  die Lautstärke.

#### 7.4 Zwei Anrufe entgegennahmen



Sie werden durch Signaltöne darauf hingewiesen (Anklöpfen), dass während des Telefonierens ein weiterer Anruf eingeht. Die Rufnummer des zweiten Anrufers wird im Display angezeigt. Sie können mit der Tastenfolge "R" "2" zwischen beiden Teilnehmern wechseln. Ein Teilnehmer wird, während Sie mit dem anderen Teilnehmer sprechen, gehalten.

**Hinweis:** Zur Nutzung von Zusatzdiensten Ihres Netzbetreibers müssen Sie die Flash-Zeit auf 300 ms einstellen (siehe Kapitel 10.5).

**Hinweis:** Die Rufnummernanzeige und das Anklöpfen ist ein optionaler Service Ihres Netzbetreibers. Bitte fragen Sie Ihren Netzbetreiber nach weiteren Informationen.

#### 7.5 Anrufe führen

- Geben Sie die Rufnummer (max. 32 Stellen) ein. Das Display zeigt maximal 12 Stellen an. Bei längeren Rufnummern werden nur die letzten 12 Stellen angezeigt.

**Hinweis:** Falsch eingegebene Ziffern löschen Sie durch kurzes Drücken der Taste . Langes Drücken der Taste  löscht die komplette Rufnummer.

- Drücken Sie die Gesprächstaste  und die Verbindung wird hergestellt.

**Hinweis:** Sie können auch zuerst die Taste  drücken und dann die Rufnummer eingeben. Die Korrektur einzelner Ziffern ist bei dieser Form des Gesprächsaufbaus nicht möglich.

## - Bedienung -

### 7.6 Gespeicherte Rufnummern aus dem Telefonbuch wählen

Im Telefonbuch gespeicherte Rufnummern (siehe "Rufnummer in das Telefonbuch eingeben" Kapitel 8.1) können Sie schnell und einfach abrufen.

1. Drücken Sie die Taste . Das Display zeigt nun in alphabetischer Reihenfolge den ersten gespeicherten Telefonbucheintrag. Mit den Tasten und können Sie einen Telefonbucheintrag auswählen. Um einen Eintrag direkt auszuwählen, drücken Sie die Taste, die dem Anfangsbuchstaben des Eintrages entspricht. Z. B. für den Namen "Peters" drücken Sie einmal die Taste "7".
2. Drücken Sie die Taste und die angezeigte Rufnummer wird gewählt.

### 7.7 Anzeige der Gesprächsdauer

Zehn Sekunden nach Beginn des Gesprächs wird im Display statt der gewählten Rufnummer die Gesprächsdauer angezeigt.

### 7.8 Mobilteilein-/ausschalten

Um das Mobilteil auszuschalten bzw. einzuschalten, drücken Sie die Taste für drei Sekunden.

**Hinweis:** Wenn Ihr Mobilteil ausgeschaltet ist, können keine Gespräche empfangen werden.

### 7.9 Einstellen der Hörerlautstärke

Drücken Sie während des Gesprächs die Tasten oder , um die Hörerlautstärke anzupassen. Es sind fünf verschiedene Lautstärken wählbar.

### 7.10 Wahlwiederholung

Die zehn zuletzt gewählten Rufnummern können erneut gewählt werden.

1. Drücken Sie die Taste . Die zuletzt gewählte Rufnummer wird im Display angezeigt.
2. Mit der Taste oder wählen Sie eine Rufnummer aus der Wahlwiederholungsliste.
3. Drücken Sie die Taste und die angezeigte Rufnummer wird gewählt.

**Hinweis:** Ist eine Rufnummer aus der Wahlwiederholungsliste im Telefonbuch gespeichert, erscheint der entsprechende Name im Display.

### 7.10.1 Eine Rufnummer aus der Wahlwiederholungslistelöschen

1. Drücken Sie die Taste und wählen Sie mit der Taste oder den zu löschenden Eintrag.
2. Drücken Sie die Taste und bestätigen Sie mit der Taste .

**Hinweis:** Die Wahlwiederholungsliste wird komplett gelöscht, wenn Sie die Taste für zwei Sekunden drücken und dann mit der Taste bestätigen.

### 7.11 Mikrophon im Mobilteil stummschalten

Wenn Sie die Taste während eines Telefongesprächs drücken, schalten Sie das Mikrophon des Mobilteils stumm. Im Display erscheint die Anzeige "Stumm". Dadurch können Sie mit einer dritten Person sprechen, ohne dass der Gesprächspartner Sie hört. Der Lautsprecher im Mobilteil bleibt eingeschaltet, sodass Sie den Gesprächspartner weiterhin hören.

Wenn Sie die Taste erneut drücken, wird die Stummschaltung aufgehoben.

### 7.12 Tastensperre ein-/ausschalten

Tragen Sie das Mobilteil bei sich, können Sie die Tastatur sperren, damit nicht ungewollt Tasten gedrückt werden. Trotz eingeschalteter Tastensperre werden eingehende Gespräche entgegengenommen.

1. Zum Einschalten der Tastensperre drücken Sie die Taste für drei Sekunden. Zum Ausschalten drücken sie zweimal die Taste .

### 7.13 Temporäre Tonwahl

Wenn Sie Ihr Telefon mit dem Impuls-Wahlverfahren betreiben, müssen Sie nicht auf die Vorteile des Ton-Wahlverfahrens (z. B. die Fernabfrage eines Anrufbeantworters) verzichten. Während eines Gesprächs wechseln Sie durch Drücken (vier Sekunden) der Taste vorübergehend zum Ton-Wahlverfahren. Nach Gesprächsende wird wieder auf Puls-Wahlverfahren umgestellt.

### 7.14 Hinweise zur Reichweite

Die Reichweite des Mobilteils beträgt ca. 50 Meter in geschlossenen Räumen und ca. 300 Meter im Freien. Bei guter Verbindung zur Basisstation erscheint im Display das Symbol .

**Hinweis:** Entfernen Sie sich zu weit von der Basisstation, blinkt das Symbol und Sie hören Warntöne. Nähern Sie sich der Basisstation, da sonst das Gespräch unterbrochen wird. Hat das Mobilteil die Verbindung zur Basisstation verloren, erscheint im Display die Meldung "BASIS 1".

### 7.15 Mobilteil suchen (Paging)



Wenn Sie Ihr Mobilteil verlegt haben, können Sie es mit Hilfe der Basis suchen.

1. Drücken Sie an der Basis die Paging-Taste . Alle an der Basis angemeldeten Mobilteile klingeln.
2. Zum Beenden der Suche drücken Sie an der Basisstation erneut die Paging-Taste oder eine beliebige Taste am Mobilteil.

## 8 Das Telefonbuch



In das Telefonbuch können 50 Rufnummern inklusive eines Namens gespeichert werden. Für die Eingabe eines Namens haben Sie 12 Buchstaben zur Verfügung. Die maximale Länge einer Rufnummer beträgt 20 Stellen.

### 8.1 Rufnummern in das Telefonbucheingeben

1. Drücken Sie dreimal die Taste .
2. Geben Sie den gewünschten Namen und die Rufnummer ein. Bestätigen Sie die jeweilige Eingabe durch Drücken der Taste .

**Hinweis:** Texteingabe siehe 8.1.2.

**Hinweis:** Ist der Name bereits im Telefonbuch gespeichert, ertönt ein Signal und im Display erscheint erneut "Hinzufügen". Sie müssen einen anderen Namen eingeben.

3. Wählen Sie mit der Taste  oder  die gewünschte Melodie und bestätigen Sie mit . Die gewählte Melodie ertönt beim Anruf des eingetragenen Gesprächspartners. Diese Zuordnung funktioniert nur, wenn Ihr Telefonanschluss und der des Anrufers über die Rufnummernanzeige CLIP verfügt.

#### 8.1.1 Hinweise zum Telefonbuch



- Geben Sie bei allen Rufnummern immer die Vorwahl mit ein, damit das Telefon auch eingehende Ortsgespräche einem Telefonbucheintrag zuordnen kann.
- Ist die Speicherkapazität von 50 Rufnummern erreicht, zeigt das Display beim nächsten Speichern die Meldung "SPEICH VOLL". Um wieder Platz zu schaffen, müssen Sie zuerst eine andere Rufnummer löschen.

#### 8.1.2 Texteingabe





Zur Eingabe des Namens sind die Zehntasten mit Buchstaben beschriftet. Durch mehrmaliges Drücken der entsprechenden Taste können Großbuchstaben sowie Zahlen eingegeben werden.

**Beispiel:** Sie möchten den Namen "Peter" eingeben.

Drücken Sie: 1 x Taste "7", 2 x Taste "3", 1 x Taste "8", 2 x Taste "3", 3 x Taste "7"

- Für ein Leerzeichen drücken Sie einmal die Taste "1", für einen Bindestrich zweimal die Taste "1".
- Um den gleichen Buchstaben zweimal einzugeben, geben Sie den entsprechenden Buchstaben ein und warten Sie dann, bis der Cursor automatisch eine Stelle weiter springt.
- Falsche Eingaben können mit der Taste  gelöscht werden.
- Um den Cursor zu bewegen, drücken Sie die Taste  oder .





### 8.2 Gespeicherte Einträge im Telefonbuch ändern

1. Drücken Sie zweimal die Taste .
2. Drücken Sie die Taste , um die Option "ÄNDERN" auszuwählen.
3. Bestätigen Sie mit der Taste  und wählen Sie mit der Taste  oder  den gewünschten Eintrag.

**Hinweis:** Um einen Eintrag direkt auszuwählen, drücken Sie die Taste, die dem Anfangsbuchstaben des Eintrages entspricht. Um z. B. den Namen "Peters" direkt auszuwählen, drücken Sie einmal die Taste "7".

4. Bestätigen Sie mit der Taste  und ändern Sie ggf. den angezeigten Namen, die Rufnummer und die Melodie. Bestätigen Sie jede Änderung durch Drücken der Taste .

### 8.3 Gespeicherte Einträge aus dem Telefonbuch löschen

1. Drücken Sie zweimal die Taste .
2. Drücken Sie die Taste , um die Option "LOESCHEN" auszuwählen.
3. Bestätigen Sie mit der Taste  und wählen Sie mit der Taste  oder  den gewünschten Eintrag.

**Hinweis:** Durch das Drücken der Taste  wird der Löschvorgang abgebrochen.

4. Bestätigen Sie das Löschen durch zweimaliges Drücken der Taste .

## - Rufnummernanzeige (CLIP) -

### 9 Rufnummernanzeige (CLIP)

Wenn Ihnen die Rufnummernanzeige zur Verfügung steht, zeigt das Display bei eingehendem Anruf die Rufnummer des Anrufers an. Haben Sie diese Rufnummer in Ihrem Telefonbuch gespeichert, wird der Name angezeigt.

Hat der Anrufer das Übertragen seiner Rufnummer unterdrückt, wird die Rufnummer nicht angezeigt. Es erscheint im Display die Meldung "NR GEHEIM".

Insgesamt werden 40 Rufnummern in der Anruferliste gespeichert, so dass Sie auch während Ihrer Abwesenheit keinen Anruf verpassen. Ist die Liste voll, wird immer die älteste Rufnummer gelöscht. Wurden während Ihrer Abwesenheit neue Rufnummern in der Anruferliste gespeichert, erscheint im Display das Symbol .







**Achtung:** Die Rufnummernanzeige (CLIP) sowie die Anzeige des Datums und der Uhrzeit ist ein optionaler Service Ihres Netzbetreibers. Bitte fragen Sie Ihren Netzbetreiber nach weiteren Informationen.

#### 9.1 Die Anruferliste

##### 9.1.1 Rufnummer aus der Anruferliste wählen

Um die Rufnummern der Anruferliste im Display zu sehen, gehen Sie bitte wie folgt vor:

1. Drücken Sie die Taste . Die zuletzt empfangene Rufnummer wird im Display angezeigt. Ist die Anruferliste leer, zeigt das Display die Meldung "LEER".
2. Mit der Taste  oder  können weitere Rufnummern aus der Anruferliste angewählt werden. Sind keine weiteren Rufnummern vorhanden, hören Sie einen Signalton. Zwei Displaysymbole informieren Sie, ob der Eintrag in der Anruferliste schon einmal angesehen wurde oder ob der Eintrag in der Anruferliste neu ist.

Display	Beschreibung
	Die Rufnummer wurde bereits angesehen.
	Die Rufnummer wurde noch nicht angesehen.

3. Um eine angezeigte Rufnummer aus der Anruferliste direkt zurückzurufen, drücken Sie die Taste .





4. Durch Drücken der Taste  verlassen Sie die Anruferliste.

**Hinweis:** Durch Drücken der Taste  werden Informationen zur angezeigten Rufnummer abgerufen:

- Ist die Rufnummer länger als 12 Stellen, werden die restlichen Zahlen angezeigt.
- Zeigt die Rufnummer, wenn der Anrufer bereits mit Namen im Telefonbuch gespeichert ist.
- Zeigt das Datum und die Uhrzeit, wenn diese Daten vom Anrufer übertragen wurden.

##### 9.1.2 Rufnummer aus der Anruferliste im Telefonbuch speichern

Eine in der Anruferliste gespeicherte Rufnummer kann direkt im Telefonbuch gespeichert werden.

1. Drücken Sie die Taste  und wählen mit  oder  die gewünschte Rufnummer. Bestätigen Sie die Auswahl durch zweimaliges Drücken der Taste .
2. Geben Sie den gewünschten Namen ein. Bestätigen Sie die Eingabe durch Drücken der Taste .

**Hinweis:** Namenseingabe siehe Kapitel 8.1.2.

**Hinweis:** Ist der Name bereits im Telefonbuch gespeichert, ertönt ein Signal und im Display erscheint wieder die ausgewählte Rufnummer.

3. Die Rufnummer wird noch einmal im Display angezeigt. Bestätigen Sie durch Drücken der Taste .

4. Wählen Sie mit den Tasten  oder  die gewünschte Melodie und bestätigen mit der Taste .

##### 9.1.3 Einzelne Rufnummer aus der Anruferliste löschen

1. Drücken Sie die Taste  und wählen mit  oder  die gewünschte Rufnummer.

**Hinweis:** Durch das Drücken der Taste  wird der Löschvorgang abgebrochen.

2. Drücken Sie die Taste . Bestätigen Sie das Löschen durch Drücken der Taste .



##### 9.1.4 Alle Rufnummern aus der Anruferliste löschen

1. Drücken Sie die Taste .







2. Drücken Sie die Taste  für 3 Sekunden. Bestätigen Sie das Löschen durch Drücken der Taste .

## 10 Sonderfunktionen









Sie haben die Möglichkeit, einige Einstellungen am Mobilteil und der Basisstation Ihren Wünschen anzupassen. Dabei ist zu beachten:

- Wenn Sie sich im Menü befinden, erscheint im Display das Symbol ⇄.
- Durch Drücken der Taste  gelangen Sie eine Menüebene zurück.  
Durch langes Drücken der Taste  brechen Sie den Vorgang an jeder Stelle im Menü ab. Das Mobilteil kehrt zurück in den Ruhezustand.
- Jeder Vorgang wird automatisch abgebrochen, wenn innerhalb von 20 Sekunden keine Eingabe erfolgt.









### 10.1 Basis - Lautstärkeinstellen

1. Drücken Sie die Taste  und wählen Sie mit der Taste  den Menüpunkt "EINSTELLUNG".
2. Bestätigen Sie mit der Taste . Das Display zeigt "BASIS-LAUTST".
3. Bestätigen Sie mit der Taste  und wählen Sie mit der Taste  oder  die gewünschte Lautstärke.
4. Bestätigen Sie mit der Taste .









### 10.2 Basis - Melodie einstellen

1. Drücken Sie die Taste  und wählen Sie mit der Taste  den Menüpunkt "EINSTELLUNG".
2. Bestätigen Sie mit der Taste  und wählen Sie mit der Taste  den Menüpunkt "BASIS-MELODY".
3. Bestätigen Sie mit der Taste  und wählen Sie mit der Taste  oder  die gewünschte Melodie.
4. Bestätigen Sie mit der Taste .

### 10.3 PIN ändern









1. Drücken Sie die Taste  und wählen Sie mit der Taste  den Menüpunkt "EINSTELLUNG".
2. Bestätigen Sie mit der Taste  und wählen Sie mit der Taste  den Menüpunkt "PIN CODE".
3. Bestätigen Sie mit der Taste , geben Sie die vierstellige PIN (Werkseinstellung "0000") ein und bestätigen Sie mit .
4. Geben Sie die neue vierstellige PIN ein und bestätigen Sie mit .
5. Geben Sie nochmal die neue PIN ein und bestätigen Sie mit .

### 10.4 Ton (MFV)- oder Impuls (I WV) - Wahlverfahren

1. Drücken Sie die Taste  und wählen Sie mit der Taste  den Menüpunkt "EINSTELLUNG".
2. Bestätigen Sie mit der Taste  und wählen Sie mit der Taste  den Menüpunkt "MFV-IWV".
3. Bestätigen Sie mit der Taste  und wählen Sie mit der Taste  oder  das gewünschte Wahlverfahren.
4. Bestätigen Sie mit der Taste .

### 10.5 Flash-Zeiteinstellen

Sie können zwei Flash-Zeiten einstellen. Flash 1 entspricht 100 ms und Flash 2 entspricht 300 ms.

1. Drücken Sie die Taste  und wählen Sie mit der Taste  den Menüpunkt "EINSTELLUNG".
2. Bestätigen Sie mit der Taste  und wählen Sie mit der Taste  den Menüpunkt "FLASHZEIT".
3. Bestätigen Sie mit der Taste  und wählen Sie mit der Taste  oder  die gewünschte Flashzeit.
4. Bestätigen Sie mit der Taste .



## - Sonderfunktionen -







### 10.6 Werkseinstellungenwiederherstellen

Mit dieser Funktion werden das Mobilteil und die Basisstation auf die Werkseinstellungen zurückgesetzt.

**Werkseinstellungen:**

Sprache: Deutsch	Name Mobilteil: DSPG
Warnton Akku: Ein	Automatische Rufannahme: Ein
Warnton Reichweite: Ein	Tonrufmelodie extern: 3
Tastenklick: Ein	Tonrufmelodie intern: 1
Hörerlautstärke: 3	Tonruflautstärke Mobilteil: 3
PIN: 0000	Tonrufmelodie Basis: 2
Pause: 3 Sekunden	Tonruflautstärke Basis: 3
Wahlverfahren: MFV/Ton	FLASH-Zeit: 100 ms











**Hinweis:** Das Telefonbuch, die Anruferliste (CLIP) und alle Rufnummern der Wahlwiederholung werden gelöscht.

1. Drücken Sie die Taste  und wählen Sie mit der Taste  den Menüpunkt "EINSTELLUNG".
2. Bestätigen Sie mit der Taste  und wählen Sie mit der Taste  den Menüpunkt "WERKSEINST".
3. Bestätigen Sie mit der Taste  und geben Sie die vierstellige PIN (Werkseinstellung "0000") ein.
4. Bestätigen Sie durch zweimaliges Drücken der Taste .  
Das Telefon ist jetzt auf die Werkseinstellungen zurückgesetzt.

### 10.7 Tastenton und Hinweistöne ein-/ausschalten

Sie können verschiedene Töne ein- oder ausschalten.









- **Tastenton**  
Jeder Tastendruck am Mobilteil wird mit einem Ton bestätigt.
- **Warnton "Akku leer"**  
Bei zu geringer Akkukapazität erinnert ein Warnton daran, dass das Mobilteil geladen werden muss.
- **Reichweitenwarnung**  
Haben Sie sich zu weit von der Basis entfernt, erklingt ein Warnton.

1. Drücken Sie die Taste  und wählen Sie mit der Taste  den Menüpunkt "MOBILTEIL".
2. Bestätigen Sie mit der Taste . Das Display zeigt "TOENE".
3. Bestätigen Sie mit der Taste  und wählen Sie mit der Taste  oder  aus den Optionen "REICHWEITE", "TASTENTON" und "AKKU LEER".
4. Bestätigen Sie mit der Taste  und wählen Sie mit der Taste  oder  die Option "EIN" bzw. "AUS".
5. Bestätigen Sie mit der Taste .

### 10.8 Mobilteil - Ruftonlautstärkeeinstellen









Die Ruftonlautstärke kann in verschiedenen Stufen eingestellt, bzw. ganz ausgeschaltet werden. Ist der Rufton ausgeschaltet, werden eingehende Anrufe an der Basisstation und im Display am Mobilteil signalisiert.

Sie können externen und internen Anrufen unterschiedliche Lautstärken zuordnen.

1. Drücken Sie die Taste  und wählen Sie mit der Taste  den Menüpunkt "MOBILTEIL".
2. Bestätigen Sie mit der Taste  und wählen Sie mit der Taste  den Menüpunkt "INT RUF LAUT" oder "EXT RUF LAUT".
3. Bestätigen Sie mit der Taste  und wählen Sie mit der Taste  oder  die gewünschte Lautstärke.
4. Bestätigen Sie mit der Taste .







### 10.9 Mobilteil - Ruftonmelodieeinstellen

Sie können externen und internen Anrufen unterschiedliche Melodien zuordnen.

1. Drücken Sie die Taste  und wählen Sie mit der Taste  den Menüpunkt "MOBILTEIL".
2. Bestätigen Sie mit der Taste  und wählen Sie mit der Taste  den Menüpunkt "INT MELODIE" oder "EXT MELODIE".
3. Bestätigen Sie mit der Taste  und wählen Sie mit der Taste  oder  die gewünschte Melodie.
4. Bestätigen Sie mit der Taste .

## - Sonderfunktionen -







### 10.10 Uhrzeiteinstellen

1. Drücken Sie die Taste  und wählen Sie mit der Taste  den Menüpunkt "MOBILTEIL".
2. Bestätigen Sie mit der Taste  und wählen Sie mit der Taste  den Menüpunkt "UHR EINST".
3. Bestätigen Sie mit der Taste  und geben Sie über das Tastenfeld die aktuelle Uhrzeit im 24-Stundenformat ein.  
Beispiel: 17:53 Uhr => 1753 oder 6:47 Uhr => 0647
4. Bestätigen Sie mit der Taste .



### 10.11 Weckerein/aus

**Hinweis:** Der Weckton erklingt nur am Mobilteil, nicht an der Basis.

Der Weckton erklingt auch, wenn die Ruftonlautstärke am Mobilteil ausgeschaltet wurde.









1. Drücken Sie die Taste  und wählen Sie mit der Taste  den Menüpunkt "MOBILTEIL".
2. Bestätigen Sie mit der Taste  und wählen Sie mit der Taste  den Menüpunkt "WECKER EINS".
3. Bestätigen Sie mit der Taste  und wählen Sie mit der Taste  oder  die Option "EIN".

**Hinweis:** Möchten Sie den Wecker ausschalten, wählen Sie unter Punkt 4 die Option "AUS" und bestätigen Sie mit der Taste .

4. Bestätigen Sie mit der Taste  und geben Sie die gewünschte Weckzeit im 24-Stundenformat ein.
5. Bestätigen Sie mit der Taste . Der Wecker ist jetzt eingeschaltet.





### 10.12 Anrufe automatisch entgegennehmen

Wenn Sie das Mobilteil aus der Basisstation nehmen, werden eingehende Anrufe automatisch entgegengenommen. Wenn Sie möchten, dass die Anrufe durch Drücken der Taste  entgegengenommen werden, schalten Sie die automatische Annahme ab.

1. Drücken Sie die Taste  und wählen Sie mit der Taste  den Menüpunkt "MOBILTEIL".
2. Bestätigen Sie mit der Taste  und wählen Sie mit der Taste  den Menüpunkt "AUTO ANNAHME".
3. Bestätigen Sie mit der Taste  und wählen Sie mit der Taste  oder  die Option "EIN" bzw. "AUS".
4. Bestätigen Sie mit der Taste .

### 10.13 Namen des Mobilteils ändern

Wenn Sie ein Gespräch beenden, erscheint im Display abwechselnd die Gesprächszeit und der Name des Mobilteils. Sind mehrere Mobilteile an der Basisstation angemeldet, ist es sinnvoll, jedem Mobilteil einen eigenen Namen zu geben.









1. Drücken Sie die Taste  und wählen Sie mit der Taste  den Menüpunkt "MOBILTEIL".
2. Bestätigen Sie mit der Taste  und wählen Sie mit der Taste  den Menüpunkt "NAME".
3. Bestätigen Sie mit der Taste  und geben Sie den gewünschten Namen ein (maximal 10 Zeichen).

**Hinweis:** Texteingabe siehe Kapitel 8.1.2.

4. Bestätigen Sie mit der Taste .

### 10.14 Sprache einstellen

Sie können die Menü-Texte in verschiedenen Sprachen anzeigen lassen.

1. Drücken Sie die Taste  und wählen Sie mit der Taste  den Menüpunkt "MOBILTEIL".
2. Bestätigen Sie mit der Taste  und wählen Sie mit der Taste  den Menüpunkt "SPRACHE".
3. Bestätigen Sie mit der Taste  und wählen Sie mit der Taste  oder  die gewünschte Sprache.
4. Bestätigen Sie mit der Taste .

## 11 Mehrere Mobilteile

Sie können fünf Mobilteile an Ihre Basisstation anmelden. Jedes Mobilteil kann gleichzeitig nur an eine Basisstation angemeldet sein.

**Hinweis:** Über den international genormten GAP Standard können SWITEL-Mobilteile und auch Mobilteile von Fremdherstellern in das Telefonsystem integriert werden. Genauso können Sie ein SWITEL-Mobilteil an Basisstationen anderer Hersteller anmelden, sofern diese Geräte nach dem GAP Standard arbeiten.

Bei der Benutzung von mehreren Mobilteilen erhalten Sie folgende Möglichkeiten:

- Interne Gespräche zwischen den Mobilteilen.
- Externe Gespräche können zwischen den Mobilteilen weitergeleitet werden.
- Eingehende externe Gespräche werden an allen Mobilteilen signalisiert.
- Konferenzgespräch mit einem externen und zwei internen Telefonen.



**Hinweis:** Benutzt bereits ein anderes Mobilteil die externe Leitung, erscheint im Display das Symbol **EXT**. Ein weiteres externes Gespräch ist nicht möglich.

### 11.1 Intern telefonieren

Sobald Sie mehrere Mobilteile an der Basisstation angemeldet haben, können Sie kostenlose interne Gespräche führen.

1. Drücken Sie die Taste **INT** und die interne Nummer des Mobilteils, z. B. "2".
2. Das Gespräch wird am gerufenen Mobilteil entgegengenommen.

**Hinweis:** Erreicht Sie während eines internen Gesprächs ein externer Anruf, hören Sie kurze Signaltöne und Sie sehen die Rufnummer des Anrufers im Display, falls diese verfügbar ist.

3. Beenden Sie das interne Gespräch durch Drücken der Taste .
4. Drücken Sie erneut die Taste  um den externen Anruf anzunehmen.

### 11.2 Externe Gespräche an ein anderes Mobilteil weiterleiten

Haben Sie ein externes Gespräch an einem Mobilteil entgegengenommen, können Sie das externe Gespräch an ein anderes Mobilteil weiterleiten.

Drücken Sie dazu die Taste **INT** und dann die interne Nummer z. B. "2" des gewünschten Mobilteils.

**Hinweis:** Sollte sich das gerufene Mobilteil nicht melden, können Sie das Gespräch durch Drücken der Taste **INT** wieder übernehmen.

Nachdem das interne Gespräch am anderen Mobilteil entgegengenommen wurde, haben Sie folgende Möglichkeiten:

1. **Rücksprache/Makeln:** Sie können nun mit dem internen Teilnehmer sprechen und durch das Drücken der Taste **INT** zum externen Gesprächspartner zurückkehren. Sie können so beliebig oft zwischen dem externen und internen Gespräch wechseln.
2. **Gespräch übergeben:** Durch Drücken der Taste  am ersten Mobilteil, wird das externe Gespräch an das gerufene Mobilteil übergeben.

### 11.3 Konferenzgesprächeführen

Ein externes Gespräch kann mit einem weiteren internen Teilnehmer zum Konferenzgespräch geschaltet werden. So können zwei Mobilteile gleichzeitig mit dem externen Teilnehmer sprechen.

1. Stellen Sie die gewünschte Verbindung zum externen Teilnehmer her.
2. Drücken Sie dann die Taste **INT** und die interne Nummer des gewünschten zweiten Mobilteils.
3. Hat der zweite, interne Teilnehmer das Gespräch entgegengenommen, drücken Sie die Taste  und alle drei Teilnehmer sind zu einer Konferenz zusammengeschaltet.









**Hinweis:** Während einer Konferenz können Sie mit der Taste **INT** den externen Gesprächspartner auf Halten setzen. Durch Drücken der Tastenfolge **INT**  schalten Sie wieder zur Konferenz zurück.

4. Die Konferenz wird durch das Auflegen eines der internen Gesprächspartner beendet.

## - Mehrere Mobilteile -

### 11.4 An- und Abmelden von Mobilteilen

#### 11.4.1 Anmelden von Mobilteilen

1. Drücken Sie die Paging-Taste ) an der Basisstation für drei Sekunden, bis Sie zwei Signaltöne hören. Melden Sie das neue Mobilteil jetzt innerhalb von 90 Sekunden an.
2. Drücken Sie die Taste  am Mobilteil und wählen Sie mit der Taste  den Menüpunkt "ANMELDEN".
3. Bestätigen Sie mit der Taste  und wählen Sie mit der Taste  oder  den Menüpunkt "BASIS ANMELD".
4. Bestätigen Sie mit der Taste  und geben Sie über das Zahlenfeld die Nummer der Basisstation ein (1 bis 4). Ist das Mobilteil bereits mit einer Basisstation verbunden, blinken die entsprechenden Nummern.
5. Bestätigen Sie mit der Taste . Die Basisstation wird gesucht.
6. Nachdem die Basisstation gefunden wurde, müssen Sie die PIN (Werkseinstellung 0 0 0 0) eingeben.
7. Bestätigen Sie mit der Taste . Nach einigen Sekunden hören Sie einen Signalton. Das Mobilteil ist nun angemeldet und kann für externe und interne Gespräche benutzt werden.







**Hinweis:** Dem Mobilteil wird eine interne Rufnummer zugeteilt. Das bereits angemeldete Mobilteil hat die interne Rufnummer 1. Das zweite angemeldete Mobilteil erhält die interne Rufnummer 2. Diese interne Rufnummer wird im Display rechts angezeigt.

#### 11.4.2 Anmelden von anderen DECT-GAP Telefonen an der Basisstation

Um ein DECT-GAP Mobilteil eines anderen Herstellers anzumelden, folgen Sie den Hinweisen in der Bedienungsanleitung des Fremdherstellers und drücken dann für 3 Sekunden die Paging-Taste ) an Ihrer Basisstation. Benutzen Sie zur Anmeldung die PIN (Werkseinstellung: 0000).

#### 11.4.3 Abmelden von Mobilteilen

Ein Mobilteil kann nur über ein anderes, noch angemeldetes Mobilteil abgemeldet werden. Es ist nicht möglich, diese Abmeldung mit dem Mobilteil durchzuführen, das abgemeldet werden soll.

1. Drücken Sie die Taste  und wählen Sie mit der Taste  den Menüpunkt "EINSTELLUNG".
2. Bestätigen Sie mit der Taste  und wählen Sie mit der Taste  oder  den Menüpunkt "MT-ABMELDEN".
3. Bestätigen Sie mit der Taste  und geben Sie über das Zahlenfeld die PIN (Werkseinstellung: 0000) ein.

**Hinweis:** Mit der Taste  brechen Sie den Vorgang ab.







4. Bestätigen Sie mit der Taste  und geben Sie die interne Nummer des abzumeldenden Mobilteils ein.
5. Bei erfolgreicher Abmeldung hören Sie nach einigen Sekunden einen Signalton. Das Mobilteil ist nun abgemeldet und kann für externe und interne Gespräche nicht mehr benutzt werden.

### 11.5 Zusätzliche Basisstationen

Bei der Verwendung mehrerer Basisstationen können Sie die Reichweite des Mobilteils vergrößern. Um diesen Effekt zu nutzen, müssen alle Basisstationen mit einem Telefonanschluss verbunden sein. Je nach Verwendungszweck können Sie jede Basisstation mit der gleichen Telefonnummer belegen oder geben Sie den Basisstationen unterschiedliche Rufnummern. Achten Sie darauf, dass sich alle Basisstationen in ihrer Reichweite überschneiden. Das Mobilteil muss an jeder Basisstation angemeldet werden. Bitte testen Sie vor jeder Inbetriebnahme einer neuen Basisstation die Reichweite des Mobilteils.

Ist ein Mobilteil an den Basisstationen angemeldet und wurde am Mobilteil die automatische Wahl der Basisstation eingeschaltet (siehe 11.5.1), wird das Mobilteil immer automatisch an die nächste Basisstation weitergeleitet.

#### 11.5.1 Wählen einer Basisstation

1. Drücken Sie die Taste  am Mobilteil und wählen Sie mit der Taste  den Menüpunkt "ANMELDEN".
2. Bestätigen Sie mit der Taste  und wählen Sie mit der Taste  oder  den Menüpunkt "BASIS-WAHL".
3. Bestätigen Sie mit der Taste . Im Display erscheinen alle Basisstationen, an denen das Mobilteil bereits angemeldet ist. Die Nummer der aktiven Basisstation blinkt. Wählen Sie über das Zahlenfeld die gewünschte Basisstation, auf die das Mobilteil umgeschaltet werden soll. Oder wechseln Sie mit der Taste  auf die Option "AUTO". Bei dieser Einstellung wechselt das Mobilteil automatisch zur nächsten Basisstation, wenn die Verbindung zur aktuellen Basisstation abbricht.

## - Fehlerbeseitigung -

### 12 Fehlerbeseitigung

Haben Sie Probleme mit Ihrem Telefon, kontrollieren Sie bitte zuerst die folgenden Hinweise.  
Bei Garantieansprüchen wenden Sie sich bitte an Ihren Fachhändler.

Fehler	Lösungen
Kein Telefongespräch möglich	<ul style="list-style-type: none"><li>- Die Telefonleitung ist nicht korrekt angeschlossen oder gestört. Verwenden Sie nur das mitgelieferte Telefonkabel.</li><li>- Testen Sie mit einem anderen Telefon, ob Ihr Telefonanschluss in Ordnung ist.</li><li>- Das Steckernetzteil ist nicht eingesteckt oder es liegt ein totaler Stromausfall vor.</li><li>- Die aufladbaren Standard-Akkus sind leer oder defekt.</li><li>- Sie haben sich zu weit von der Basisstation entfernt.</li></ul>
Verbindung abgehackt, fällt aus	<ul style="list-style-type: none"><li>- Sie haben sich zu weit von der Basisstation entfernt.</li><li>- Falscher Aufstellungsort der Basisstation.</li></ul>
Keine Wahl möglich	<ul style="list-style-type: none"><li>- Wahlverfahren falsch eingestellt (siehe Kapitel 10.4).</li></ul>
Das System reagiert nicht mehr oder befindet sich in einem undefinierten Zustand	<ul style="list-style-type: none"><li>- Stellen Sie die Werkseinstellungen wieder her (siehe Kapitel 10.6). Ziehen Sie vorher kurzzeitig das Netzteil aus der Steckdose.</li></ul>
Die Ladekontrollleuchte leuchtet nicht	<ul style="list-style-type: none"><li>- Stellen Sie das Mobilteil richtig auf die Basisstation, reinigen Sie die Kontaktflächen am Mobilteil und an der Basisstation mit einem weichen, trockenen Tuch.</li></ul>
Im Display blinkt nach ein paar Stunden das Batterie-Symbol	<ul style="list-style-type: none"><li>- Stellen Sie das Mobilteil für 14 Stunden in die Basisstation. Hilft dies nicht, erneuern Sie die aufladbaren Standard-Akkus.</li></ul>
Display-Anzeige dunkel	<ul style="list-style-type: none"><li>- Verursacht durch direkte Sonneneinstrahlung, Mobilteil abkühlen lassen.</li></ul>

## - Wichtige Informationen -

### 13 Wichtige Informationen

#### 13.1 Technische Daten

Merkmal	Wert
Standard	DECT-GAP
Stromversorgung	Basisstation 220/230 V, 50 Hz
Reichweite (Außen/Innen)	300 m / 50 m
Standby	bis zu 110 h
Max. Gesprächsdauer	bis zu 10 h
Aufladbare Standard-Akkus	2 x AAA (1.2V / 550 mAh)
Wahlverfahren	MFV oder IWV
Zulässige Umgebungstemperatur	10°C bis 30°C
Zulässige relative Luftfeuchtigkeit	20% bis 75%
Flash-Zeiten	100 ms oder 300 ms

DECT: **D**igital **E**uropean **C**ordless **T**elephone = Standard für kabellose Telefone.

GAP: **G**eneric **A**ccess **P**rofile = Standard für das Zusammenwirken von Mobilteilen und Basisstationen anderer Hersteller.

#### 13.2 Garantie

Switel - Geräte werden nach den modernsten Produktionsverfahren hergestellt und geprüft. Ausgesuchte Materialien und hoch entwickelte Technologien sorgen für einwandfreie Funktion und lange Lebensdauer. Ein Garantiefall liegt nicht vor, wenn die Ursache einer Fehlfunktion des Gerätes bei dem Telefonnetzbetreiber oder einer eventuell zwischengeschalteten Nebenstellenanlage liegt. Die Garantie gilt nicht für die in den Produkten verwendeten Standard-Akkus oder Akkupacks. Die Garantiezeit beträgt 24 Monate, gerechnet vom Tage des Kaufs.

Innerhalb der Garantiezeit werden alle Mängel, die auf Material- oder Herstellungsfehler zurückzuführen sind, kostenlos beseitigt. Der Garantieanspruch erlischt bei Eingriffen durch den Käufer oder durch Dritte. Schäden, die durch unsachgemäße Behandlung oder Bedienung, durch falsches Aufstellen oder Aufbewahren, durch unsachgemäßen Anschluss oder Installation sowie durch höhere Gewalt oder sonstige äußere Einflüsse entstehen, fallen nicht unter die Garantieleistung. Wir behalten uns vor, bei Reklamationen die defekten Teile auszubessern oder zu ersetzen oder das Gerät auszutauschen. Ausgetauschte Teile oder ausgetauschte Geräte gehen in unser Eigentum über. Schadenersatzansprüche sind ausgeschlossen, soweit sie nicht auf Vorsatz oder grober Fahrlässigkeit des Herstellers beruhen.

Sollte Ihr Gerät dennoch einen Defekt innerhalb der Garantiezeit aufweisen, wenden Sie sich bitte unter Vorlage Ihrer Kaufquittung ausschließlich an das Geschäft, in dem Sie Ihr SWITEL - Gerät gekauft haben. Alle Gewährleistungsansprüche nach diesen Bestimmungen sind ausschließlich gegenüber Ihrem Fachhändler geltend zu machen. Nach Ablauf von zwei Jahren nach Kauf und Übergabe unserer Produkte können Gewährleistungsrechte nicht mehr geltend gemacht werden.

## - Table des matières -

<b>1</b>	<b>Généralités</b> .....	<b>25</b>
1.1	Utilisation conforme aux prescriptions .....	25
1.2	Panne de courant .....	25
1.3	Lieu d'installation .....	25
1.4	Bloc secteur .....	25
1.5	Piles rechargeables standard .....	25
1.6	Chargement du combiné .....	25
1.7	Installations à postes supplémentaires .....	25
1.8	Remarques concernant l'élimination .....	25
1.9	Remarque relative aux appareils médicaux .....	25
1.10	Température et conditions d'environnement .....	26
1.11	Nettoyage et entretien .....	26
<b>2</b>	<b>Caractéristiques</b> .....	<b>26</b>
2.1	Téléphone .....	26
<b>3</b>	<b>Éléments de manipulation</b> .....	<b>27</b>
3.1	Combiné .....	27
3.2	Base .....	27
<b>4</b>	<b>Installations à postes supplémentaires / services supplémentaires</b> .....	<b>28</b>
4.1	Touche R avec les installations à postes supplémentaires .....	28
4.2	Touche R et les services supplémentaires de la Swisscom .....	28
4.3	Pause de numérotation .....	28
<b>5</b>	<b>Mise en service</b> .....	<b>29</b>
5.1	Remarques concernant la sécurité .....	29
5.2	Contrôle du contenu du paquet .....	29
5.3	Branchement de la base .....	29
5.4	Pose des piles rechargeables standard .....	29
5.5	Rechargement des piles rechargeables standard .....	29
5.6	Numérotation par tonalité (Tone) ou par impulsions (Pulse) .....	29
<b>6</b>	<b>Structure du menu</b> .....	<b>30</b>
<b>7</b>	<b>Manipulation</b> .....	<b>32</b>
7.1	L'écran .....	32
7.2	Répondeur externe .....	32
7.3	Comment prendre un appel .....	32
7.4	Prise de deux appels .....	32
7.5	Comment téléphoner .....	32
7.6	Composition des numéros d'appel enregistrés dans le répertoire .....	33
7.7	Affichage de la durée de la communication .....	33
7.8	Activation / désactivation du combiné .....	33
7.9	Réglage du volume sonore de l'écouteur .....	33
7.10	BIS .....	33
7.10.1	Suppression d'un numéro d'appel issu de la liste de répétition des derniers numéros .....	33
7.11	Désactivation du microphone du combiné (silencieux) .....	33
7.12	Activer / désactiver le verrouillage du clavier .....	33
7.13	Numérotation temporaire par tonalité .....	33
7.14	Remarque concernant la portée .....	33
7.15	Chercher un combiné (paging) .....	33
<b>8</b>	<b>Le répertoire</b> .....	<b>34</b>
8.1	Saisie des numéros d'appel dans le répertoire .....	34
8.1.1	Remarques concernant le répertoire .....	34
8.1.2	Saisie de textes .....	34
8.2	Modification d'enregistrements sauvegardés dans le répertoire .....	34
8.3	Suppression d'enregistrements sauvegardés dans le répertoire .....	34

## - Table des matières -

<b>9</b>	<b>Affichage du numéro d'appel (CLIP) -</b> .....	<b>35</b>
9.1	Le journal des appels .....	35
9.1.1	Sélection des numéros d'appel du journal des appels .....	35
9.1.2	Enregistrement des numéros d'appel issus du journal des appels dans le répertoire .....	35
9.1.3	Suppression individuelle de numéros d'appel issus du journal des appels .....	35
9.1.4	Suppression de tous les numéros d'appel du journal des appels .....	35
<b>10</b>	<b>Fonctions spéciales</b> .....	<b>36</b>
10.1	Réglage du volume sonore de la base .....	36
10.2	Réglage de la mélodie de la base .....	36
10.3	Modification du code PIN .....	36
10.4	Numérotation par tonalité (Tone) ou par impulsions (Pulse) .....	36
10.5	Programmation du temps de flash .....	36
10.6	Restauration des réglages usines .....	37
10.7	Activation / désactivation du son des touches et des signaux sonores d'avertissement .....	37
10.8	Réglage du volume sonore du combiné .....	37
10.9	Réglage de la mélodie de la sonnerie du combiné .....	37
10.10	Réglage de l'heure .....	38
10.11	Activation/désactivation de l'alarme .....	38
10.12	Prise automatique d'appels .....	38
10.13	Modification du nom du combiné .....	38
10.14	Réglage de la langue .....	38
<b>11</b>	<b>Plusieurs combinés</b> .....	<b>39</b>
11.1	Téléphoner à l'intérieur .....	39
11.2	Transfert de communications externes à un autre combiné .....	39
11.3	Téléphoner en conférence .....	39
11.4	Déclaration et annulation de combinés .....	40
11.4.1	Déclaration de combinés .....	40
11.4.2	Déclaration d'autres téléphones DECT-GAP sur la base .....	40
11.4.3	Annulation des combinés .....	40
11.5	Bases supplémentaires .....	40
11.5.1	Sélection d'une base .....	40
<b>12</b>	<b>Elimination des perturbations</b> .....	<b>41</b>
<b>13</b>	<b>Informations importantes</b> .....	<b>42</b>
13.1	Données techniques .....	42
13.2	Garantie .....	42



## 1 Généralités

Veillez lire ce mode d'emploi attentivement et complètement. N'ouvrez en aucun cas l'appareil et n'effectuez aucun essai de réparation vous-même. En ce qui concerne le droit à la garantie, adressez-vous à votre revendeur. Dans le cadre des améliorations de produit, nous nous réservons le droit d'apporter à l'article des modifications techniques et d'optique.

### 1.1 Utilisation conforme aux prescriptions

Ce téléphone est conçu pour fonctionner avec un raccordement téléphonique analogique (PSTN) à l'intérieur de la Suisse. Toutefois, en raison des différences entre les divers exploitants de réseaux de télécommunication, on ne peut pas garantir un fonctionnement impeccable avec chaque raccordement de périphérique de télécommunication. Ne branchez le câble de raccordement du téléphone que dans une prise téléphonique prévue à cet effet. Ne remplacez pas la fiche du câble de raccordement.

### 1.2 Panne de courant

En cas de panne de courant, on ne peut pas téléphoner avec le téléphone. Ayez en réserve, pour d'éventuels cas d'urgence, un téléphone à fil fonctionnant sans alimentation en courant externe.

### 1.3 Lieu d'installation

Le lieu d'installation exerce une influence décisive sur le fonctionnement impeccable du téléphone. Une prise réseau de 230 Volt doit se trouver sur le lieu d'installation.

Ne posez pas la base dans les environs immédiats d'autres appareils électroniques comme par ex. le micro-ondes ou des appareils HIFI car sinon ils peuvent exercer une influence réciproque. Respectez donc une distance d'au moins un mètre par rapport aux appareils électroniques. Posez la base sur une surface plane et antidérapante. Normalement, les pieds de la base ne laissent pas de traces sur la surface sur laquelle ils reposent. Toutefois, en raison de la diversité des laques et des surfaces utilisées, il n'est pas exclu que les pieds de l'appareil puissent laisser des traces sur la surface d'installation.

### 1.4 Bloc secteur

N'utilisez que le bloc d'alimentation enfichable de SWITEL fourni avec l'appareil car d'autres blocs d'alimentation peuvent détruire le téléphone. Ne pas ouvrir le bloc d'alimentation. Il y a danger de mort à ouvrir le bloc d'alimentation tant qu'il est raccordé au réseau.

### 1.5 Piles rechargeables standard

Utilisez les piles rechargeables standard fournies avec l'appareil. Lors du remplacement des piles, n'utilisez toujours que des piles rechargeables standard du type AAA 1,2V 550mAh. D'autres piles rechargeables standard ou des packs de piles rechargeables peuvent provoquer un court-circuit.

Ne jetez jamais les piles rechargeables standard dans le feu et ne les plongez pas dans l'eau. Les temps maximaux de veille et de communication indiqués se rapportent aux piles rechargeables standard fournies avec l'appareil quand elles fonctionnent dans des conditions optimales.

La température ambiante, le cycle de rechargement et autres facteurs influants comme par ex. les perturbations radio dans tout l'environnement peuvent considérablement réduire les temps de fonctionnement. La capacité de charge se réduit, en outre, pour des raisons techniques au cours de son utilisation ou en raison de son stockage à très hautes ou très basses températures.

### 1.6 Chargement du combiné

Le combiné chauffe lors du chargement. C'est normal et ce n'est pas dangereux. Ne chargez pas le combiné avec des appareils de recharge autres car sinon des dommages peuvent se produire.

### 1.7 Installations à postes supplémentaires

On peut également raccorder le téléphone à une installation à postes supplémentaires. Votre revendeur, chez lequel vous avez acheté l'installation, vous dira si votre téléphone fonctionne impeccablement sur votre installation à postes supplémentaires. **Il ne peut pas** être garanti que le téléphone fonctionne avec chaque installation à postes supplémentaires.

### 1.8 Remarques concernant l'élimination

L'application du droit européen dans les lois nationale et les décrets vous contraignent à éliminer comme il se doit les biens de consommation. Cela sert à la protection des personnes et de l'environnement.

Le symbole placé ci-contre signifie que les anciens appareils électriques et électroniques ainsi que les piles ne doivent pas être éliminés avec les ménagères normales.

**Veillez éliminer les anciens appareils usés** dans un centre de collecte d'un organisme approprié d'évacuation des déchets.

Veillez éliminer les **piles et piles rechargeables** chez un revendeur de piles ainsi que dans les centres de collecte responsables qui mettent des collecteurs appropriés à votre disposition.

Éliminez les **fournitures d'emballage** conformément au règlement local.

### 1.9 Remarque relative aux appareils médicaux

Le téléphone travaille avec une puissance d'émission très faible. Cette puissance d'émission faible exclut un risque pour la santé selon le niveau actuel de la recherche et de la technique. Mais il s'avère que des téléphones portables branchés peuvent influencer les appareils médicaux. N'utilisez donc pas le téléphone dans les environs d'appareils médicaux. Une influence des téléphones DECT sur les stimulateurs cardiaques n'a pas été observée jusqu'à présent, mais ne peut toutefois pas être entièrement exclue. Les téléphones DECT peuvent causer un bourdonnement désagréable dans les prothèses auditives.



## - Généralités -

### 1.10 Température et conditions d'environnement

Le téléphone est conçu pour fonctionner dans des pièces abritées d'une température de 10 °C à 30 °C. La base ne doit pas être placée dans des pièces humides comme la salle de bains ou la buanderie. Evitez le contact avec des sources de chaleur comme les radiateurs et n'exposez pas l'appareil à l'ensoleillement direct.

N'utilisez pas le combiné dans des régions susceptibles d'explosion.

Evitez toute nuisance par la fumée, la poussière, les tremblements, les produits chimiques, l'humidité, la grande chaleur ou l'ensoleillement direct.

### 1.11 Nettoyage et entretien

Nettoyez les surfaces du boîtier avec un chiffon sec, doux et non pelucheux. N'utilisez pas de produits d'entretien ou de solvants agressifs. Mis à part un nettoyage occasionnel du boîtier, aucun entretien n'est nécessaire. Les pieds en caoutchouc de la base ne résistent pas à tous les produits d'entretien. Le fabricant ne peut donc être tenu responsable pour des éventuels dommages causés sur des meubles ou autres objets de ce genre.

## - Caractéristiques -

## 2 Caractéristiques

### 2.1 Téléphone

- DECT/GAP numérique standard
- Jusqu'à 10 heures de communication - jusqu'à 110 heures en mode de veille
- Codage de la parole pour une grande sécurité
- Numérotation par tonalité / par impulsions (Tone / Pulse)
- Affichage du numéro d'appel sur l'écran (CLIP)
- Liste d'appels pour max. 40 numéros d'appel
- Répétition des 10 derniers numéros d'appel
- Répertoire pour 50 numéros d'appel, noms inclus
- Horloge de 24 heures avec fonction réveil/alarme intégrée au combiné
- Affichage de la durée de la communication
- Extensible grâce à d'autres combinés DECT, GAP compatibles
- Fonctionnement en liaisons multiples, jusqu'à 5 combinés supplémentaires
- Communications internes gratuites possibles entre deux combinés
- Conférences téléphoniques entre deux combinés et un correspondant externe
- Transfert d'un appel entre deux combinés
- Mélodie de sonnerie à réglage multiple pour le combiné et la base
- Appel VIP (attribution de mélodies)
- Conçu pour les services supplémentaires de Swisscom (Hook-Flash), utilisable sur des postes supplémentaires
- Désactivation de micro (silencieux)
- Verrouillage du clavier

DECT: **D**igital **E**uropean **C**ordless **T**elephone = Standard pour téléphones sans fil.

GAP : **G**eneric **A**ccess **P**rofile = Standard pour l'action conjointe de combinés et de bases de fabricants différents.

## - *Éléments de manipulation* -

### 3 **Éléments de manipulation**

#### 3.1 **Combiné**

1. Affichage de communications
2. Répétition automatique des derniers numéros
3. Menu
4. Répertoire (annuaire)
5. Touches de sélection / Journal des appels CLIP
6. Communications internes et en conférence
7. Touche de signal R / Marche / Arrêt
8. Touche de communication
9. Silencieux / Touche de suppression

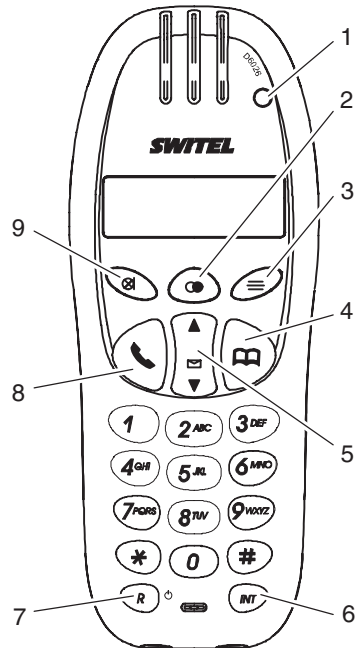

#### 3.2 **Base**

10. Touche de paging (recherche du combiné)
11. Indicateur par DEL de communication et d'alimentation
12. Voyant de charge par DEL

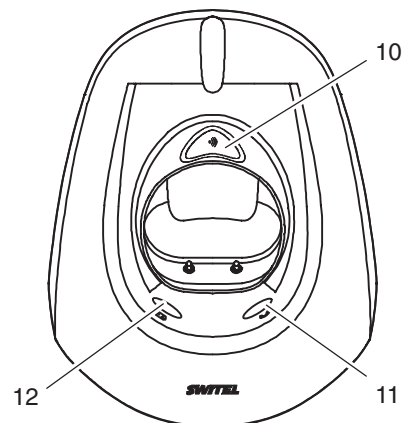

## **4 Installations à postes supplémentaires / services supplémentaires**

Vous pouvez vous servir de la touche "R" de votre téléphone sur des installations à postes supplémentaires et si vous utilisez les services confort de votre exploitant de réseau..

### **4.1 Touche R avec les installations à postes supplémentaires**

Si votre téléphone est raccordé à une installation à postes supplémentaires, vous pouvez, par l'intermédiaire de la touche "R", tirer profit de toutes les possibilités comme par ex. le transfert d'appels, le rappel automatique etc. Un temps de flash de 100 ms est nécessaire avec une installation à postes supplémentaires (pour le réglage, voir au chapitre 10.5). Votre revendeur, chez lequel vous avez acheté l'installation, vous dira si votre téléphone fonctionne impeccablement sur votre installation à postes supplémentaires.

### **4.2 Touche R et les services confort de votre exploitant de réseau**

Votre téléphone SWITEL supporte les services confort les plus importants de votre exploitant de réseau (par ex. le va-et-vient, la signalisation d'appel en instance, la conférence à trois). Pour utiliser les services confort de votre exploitant de réseau, vous devez régler le temps de flash sur 100 ms (pour le réglage, voir au chapitre 10.5).

Pour la déconnexion des services confort, veuillez vous adresser à votre exploitant de réseau.

### **4.3 Pause de numérotation**

Dans le cas d'installations à postes supplémentaires, il est nécessaire de composer un certain numéro (par ex. le "9" ou le "0") pour obtenir la tonalité de ligne principale. Sur quelques installations à postes supplémentaires plus anciennes, il faut attendre quelques instants pour entendre la tonalité. Spécialement pour ces installations à postes supplémentaires, on peut, après la prise de ligne, introduire une pause automatique afin de pouvoir continuer à composer directement le numéro sans devoir attendre la tonalité.

Appuyez une fois sur la touche  entre le chiffre de la ligne principale et le numéro d'appel. L'affichage "P" apparaît sur l'écran. Après la prise de ligne, votre téléphone attend 3 secondes pour composer le numéro d'appel réel.

**Remarque :** La pause peut également être enregistrée dans le répertoire lors de la saisie de numéros d'appel.

## - Mise en service -

### 5 Mise en service

#### 5.1 Remarques concernant la sécurité



**Attention :** Avant la mise en service, vous devez lire les généralités se trouvant au début de ce mode d'emploi.

#### 5.2 Contrôle du contenu du paquet

Les éléments suivants font partie de la livraison :

une base	un câble de raccordement téléphonique
un combiné	deux piles rechargeables standard
un bloc d'alimentation	un mode d'emploi

#### 5.3 Branchement de la base

Assurez-vous que la base se trouve dans les environs de votre prise de raccordement téléphonique et d'une prise réseau. N'utilisez que les composants livrés avec l'appareil.

1. Introduire la petite fiche du bloc d'alimentation dans la prise correspondante située sur la face inférieure de la base.

**Remarque:** Vous ne pouvez pas vous tromper en branchant la fiche : la fiche et la prise sont, de par leur construction, protégées contre toute inversion de polarité. Les fiches doivent s'encliqueter de façon audible dans les prises de la base.

2. Mettre la petite fiche du câble de raccordement téléphonique dans la prise correspondante située sur la face inférieure de la base.
3. Introduisez les deux câbles de la face inférieure de la base dans le canal pour câble prévu à cet effet et situé sur la face arrière.
4. Branchez le bloc d'alimentation dans une prise de réseau de 230 volts installée selon les spécifications. Le bloc d'alimentation de la base doit toujours rester branché.
5. Reliez le câble de raccordement téléphonique ci-joint avec la prise téléphonique.

#### 5.4 Pose des piles rechargeables standard

Pour placer dans le combiné les piles rechargeables standard fournies avec l'appareil, appuyez sur le bord supérieur du cache du compartiment à piles puis poussez-le vers le bas. Placez ensuite les piles rechargeables standard. Tenez compte de la polarisation correcte. Fermez le compartiment à piles.

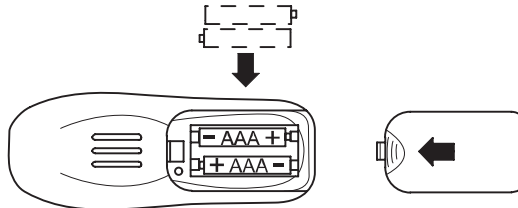

#### 5.5 Rechargement des piles rechargeables standard

Posez le combiné sur la base, écran vers l'avant, et laissez-le pendant au moins 14 heures. Le voyant de charge clignote sur la base. Si les piles rechargeables standard ne sont pas correctement rechargées, il peut y avoir des erreurs de fonctionnement de la part du téléphone.

Les piles rechargeables standard de votre combiné possèdent un temps de veille de max. 110 heures à température ambiante. La durée maximale de communication est de 10 heures.

Le niveau actuel de chargement des piles est affiché sur l'écran :

Plein	Moyen	Faible	Vide

#### 5.6 Numérotation par tonalité (Tone) ou par impulsions (Pulse)

Cette caractéristique vous permet de vous servir de votre téléphone tant sur les raccordements analogiques (numérotation par impulsions/pulse) que sur les raccordements numériques (numérotation par tonalité/tone). L'usine a réglé l'appareil sur la numérotation par tonalité. Si votre téléphone devait ne pas fonctionner sur votre raccordement, veuillez consulter le chapitre 10.4 pour savoir comment faire passer votre téléphone en numérotation par impulsions.

**- Structure du menu -**

**6 Structure du menu**

Vous trouverez ci-dessous la structure du menu de votre téléphone. En mode de veille, ouvrez la sélection de menu en appuyant sur la touche .

Répertoire	Ajouter	Nom ?	Numéro ?	Mélodie 1-5
	Modifier			
	Supprimer			

Réglage	Volume base	Volume 1, 2, 3, 4, 5, Volume coupé		
	Mélodie base	Mélodie 1, 2, 3, 4, 5		
	Supp combiné	PIN ? (réglage usine 0000)		
	Code PIN	PIN ? (réglage usine 0000)	Nouveau PIN	Retaper
	Numérotation	Fréq vocale		
		Décimale		
	Touche R	Réglage 1		
		Réglage 2		
	Régl défaut	PIN ? (réglage usine 0000)	Confirmer ?	

**- Structure du menu -**











Combiné	Bips	Bip touche	Active - désactivé
		Batterie faible	Activé - désactivé
		Hors portée	Activé - désactivé
	Vol son int	Volume 1, 2, 3, 4, 5, Volume coupé	
	Vol son ext	Volume 1, 2, 3, 4, 5, Volume coupé	
	Mélodie int	Mélodie 1, 2, 3, 4, 5	
	Mélodie ext	Mélodie 1, 2, 3, 4, 5	
	Rég heure	Heure actuelle	
	Alarme	Activé - désactivé	Heure de l'alarme
	Réponse auto	Activé - désactivé	
	Nom	.....	
	Langue	Deutsch	
		English	
		Français	
		Italiano	
	Verr clavier		

Déclarer	Choix base	BS 1 _ _ _
		Auto
	Decl. base	BS 1 2 3 4



## -Manipulation

### 7 Manipulation

#### 7.1 L'écran

Ecran	Description
	<b>Constant :</b> Vous passez une communication.
EXT	<b>Constant :</b> Vous passez une communication externe. <b>Clignote :</b> Un appel externe vous parvient.
	<b>Constant :</b> Vous passez une communication interne. <b>Clignote :</b> Un appel interne vous parvient.
	<b>Constant :</b> Vous vous trouvez dans le journal des appels. <b>Clignote :</b> Il existe de nouveaux appels dans le journal des appels.
	<b>Constant :</b> Vous n'avez pas répondu à ce numéro d'appel du journal des appels.
	<b>Constant :</b> Vous avez répondu à ce numéro d'appel du journal des appels.
	<b>Clignote :</b> Recharger les piles rechargeables. <b>Constant :</b> Affichage de la capacité des piles. <b>Passage des segments :</b> Les piles rechargeables sont en train d'être chargées.
	<b>Constant :</b> Vous vous trouvez dans le répertoire.
	<b>Constant :</b> La programmation est activée.
	<b>Constant :</b> Le verrouillage du clavier est activé.
	<b>Constant :</b> La liaison avec la base est bonne. <b>Clignote :</b> La portée de la base est dépassée.
	<b>Constant :</b> Le numéro d'appel est supérieur à 12 chiffres.

#### 7.2 Répondeur externe

Le symbole  vous signale que vous avez de nouveaux messages sur votre répondeur externe. L'affichage du symbole  n'est possible qu'avec un raccordement téléphonique numérique. Après l'écoute des messages, le symbole s'éteint.



**Attention :** Le répondeur externe et la transmission du symbole  est un service optionnel de votre exploitant de réseau. Veuillez demander de plus amples informations à votre exploitant de réseau.

#### 7.3 Comment prendre un appel

A l'arrivée d'un appel, la sonnerie d'appel du combiné et de la base se fait entendre. décrochez le combiné de la base ou appuyez sur la touche de communication . La liaison est établie.

Pour terminer la conversation, remettez le combiné sur la base ou appuyez sur la touche .

**Remarque :** Si le combiné sonne, modifiez le volume sonore en appuyant sur la touche  ou .

#### 7.4 Prise de deux appels



Des signaux sonores vous feront remarquer (signalisation d'appel en instance) qu'un autre appel vous parvient pendant que vous téléphonez. Vous pouvez voir à l'écran le numéro du deuxième correspondant. Vous pouvez, avec la combinaison de touches "R" "2", passer d'un correspondant à l'autre. Un correspondant sera maintenu en ligne pendant que vous parlez avec l'autre correspondant.

**Remarque :** Pour utiliser les services supplémentaires de la SWISSCOM, vous devez régler le temps de flash sur 300 ms (voir chapitre 10.5).

**Remarque :** L'affichage du numéro d'appel et la signalisation d'appel en instance sont des services optionnels de votre exploitant de réseau. Veuillez demander de plus amples informations à votre exploitant de réseau.

#### 7.5 Comment téléphoner

1. Saisissez le numéro d'appel (max. 32 chiffres). L'écran affiche 12 positions maximum. Dans le cas de numéros d'appel plus longs, seules les dernières 12 positions seront affichées.

**Remarque :** Vous effacez les chiffres saisis de manière erronée en appuyant rapidement sur la touche . En appuyant longtemps sur la touche , vous supprimez le numéro d'appel entier.

2. Appuyez sur la touche de communication  et la liaison s'établit.





**Remarque :** Vous pouvez appuyer d'abord sur la  puis après saisir le numéro d'appel. La correction de chiffres individuels n'est pas possible quand la communication est établie de cette manière.



## -Manipulation

### 7.6 Composition des numéros d'appel enregistrés dans le répertoire

Vous pouvez appeler rapidement et facilement les numéros d'appel enregistrés dans le répertoire (voir "Saisie des numéros d'appel dans le répertoire" chapitre 8.1).

1. Appuyez sur la touche . L'écran montre maintenant en ordre alphabétique le premier enregistrement téléphonique.  
Avec les touches  et , vous pouvez sélectionner un enregistrement du répertoire. Pour sélectionner directement un enregistrement, appuyez sur la touche qui correspond à la première lettre de l'enregistrement. Par ex. pour le nom "Peters", appuyez une fois sur la touche "7".
2. Appuyez sur la touche  et le numéro d'appel affiché sera composé.

### 7.7 Affichage de la durée de la communication



Dix secondes après le début de la communication, la durée de la communication s'affiche à l'écran à la place du numéro d'appel composé.

### 7.8 Activation / désactivation du combiné

Pour désactiver ou activer le combiné, appuyez pendant trois secondes sur la touche .





**Remarque :** Si votre combiné est désactivé, vous ne pouvez pas recevoir de communications.

### 7.9 Réglage du volume sonore de l'écouteur

Appuyez sur la touche  ou  pendant la communication pour adapter le volume sonore de l'écouteur. Vous pouvez sélectionner cinq volumes sonores différents.





### 7.10 BIS



Il est possible de numéroté à nouveau les dix derniers numéros d'appel composés.

1. Appuyez sur la touche . Le numéro d'appel composé en dernier apparaît à l'écran.
2. La touche  ou  vous permet de composer un numéro d'appel issu de la liste de répétition des derniers numéros.
3. Appuyez sur la touche  et le numéro d'appel affiché sera composé.

**Remarque :** Si un numéro d'appel issu de la liste de répétition des derniers numéros est enregistré dans le répertoire, le nom correspondant apparaît à l'écran.

### 7.10.1 Suppression d'un numéro d'appel issu de la liste de répétition des derniers numéros

1. Appuyez sur la touche  et sélectionnez l'enregistrement à supprimer en appuyant sur la touche  ou .
2. Appuyez sur la touche  et confirmez avec la touche .

**Remarque :** La liste de répétition des derniers numéros sera entièrement supprimée si vous appuyez sur la touche  pendant deux secondes et que vous confirmez ensuite avec la touche .



### 7.11 Désactivation du microphone du combiné (silencieux)

Si vous appuyez sur la touche  pendant une communication téléphonique, vous branchez le microphone du combiné sur "Silencieux". "Micro coupé" s'affiche à l'écran. Vous pouvez ainsi parler à une tierce personne sans que le correspondant vous entende. Le haut-parleur du combiné reste branché si bien que vous pouvez continuer à entendre le correspondant.

Si vous appuyez à nouveau sur la touche , le mode "Silencieux" sera supprimé.

### 7.12 Activer / désactiver le verrouillage du clavier

Si vous portez le combiné sur vous, vous pouvez verrouiller le clavier afin que les touches ne puissent pas être actionnées involontairement. Même si le verrouillage des touches est activé, il est possible de répondre aux communications qui arrivent.

1. Pour activer le verrouillage du clavier, appuyez sur la touche  pendant trois secondes. Pour désactiver, appuyez deux fois sur la touche .

### 7.13 Numérotation temporaire par tonalité

Si vous utilisez votre téléphone avec la numérotation par impulsions, vous n'avez pas besoin de renoncer aux avantages de la numérotation par tonalité (par ex. : consultation à distance d'un répondeur). Pendant une communication, passez temporairement en numérotation par tonalité en appuyant (quatre secondes) sur la touche . A la fin de la communication, le téléphone passe de nouveau en numérotation par impulsions.

### 7.14 Remarque concernant la portée

La portée du combiné est d'env. 50 mètres en pièces fermées et d'env. 300 mètres à l'extérieur. Si la connexion avec la base est bonne, le symbole  apparaît à l'écran.

**Remarque :** Si vous vous éloignez trop de la base, le symbole  clignote et vous entendez des avertissements sonores. Rapprochez vous de la base car sinon la communication sera interrompue. Si le combiné a perdu la liaison avec la base, le message "BASE 1" apparaît à l'écran.

### 7.15 Chercher un combiné (paging)

Si vous avez égaré votre combiné, vous pouvez le rechercher à l'aide de la base.

1. Appuyez sur la touche de paging  de la base. Tous les combinés déclarés sur la base sonnent.
2. Pour achever la recherche, réappuyez sur la touche de paging K de la base ou sur une touche quelconque du combiné.

### 8 Le répertoire



Vous pouvez enregistrer 50 numéros d'appel, nom inclus, dans le répertoire. Pour la saisie d'un nom, vous avez 12 lettres à votre disposition. La longueur maximale d'un numéro d'appel est de 20 positions.

#### 8.1 Saisie des numéros d'appel dans le répertoire

1. Appuyez trois fois sur la touche .
2. Saisissez le nom désiré et le numéro d'appel. Confirmez chaque saisie en appuyant sur la touche .

**Remarque :** Pour la saisie de textes, voir 8.1.2.

**Remarque :** Si le nom est déjà enregistré dans le répertoire, un signal se fait entendre et "Ajouter" apparaît de nouveau à l'écran. Vous devez saisir un autre nom.

3. Sélectionnez la mélodie désirée en appuyant sur la touche  ou  et confirmez avec .  
La mélodie se fait entendre à l'appel du correspondant enregistré. Cette attribution ne fonctionne que si votre raccordement téléphonique et celui du correspondant disposent de l'affichage du numéro d'appel CLIP.

#### 8.1.1 Remarques concernant le répertoire



- Saisissez toujours les numéros d'appel avec l'indicatif afin que le téléphone puisse aussi attribuer les communications locales à un enregistrement du répertoire.
- Si la capacité d'enregistrement de 50 numéros d'appel est atteinte, l'écran affiche le message "MEM PLEINE" lors de l'enregistrement suivant. Pour faire à nouveau de la place, vous devez tout d'abord supprimer un autre numéro d'appel.

#### 8.1.2 Saisie de textes

Pour permettre la saisie de noms, des lettres sont inscrites sur les touches chiffrées. En appuyant plusieurs fois sur la touche correspondante, on peut saisir des majuscules ainsi que des chiffres.

**Exemple :** Vous désirez saisir le nom "Peter".



Appuyez : 1 x sur la touche "7", 2 x sur la touche "3", 1 x sur la touche "8", 2 x sur la touche "3", 3 x sur la touche "7"

- Pour créer un espace, appuyez une fois sur la touche "1" et pour obtenir un trait d'union, appuyez deux fois sur la touche "1".
- Pour saisir deux fois la même lettre, saisissez la lettre correspondante et attendez ensuite que le curseur passe automatiquement à la position suivante.
- Vous pouvez supprimer des entrées erronées avec la touche .
- Pour faire se déplacer le curseur, appuyez sur la touche  ou .

#### 8.2 Modification d'enregistrements sauvegardés dans le répertoire

1. Appuyez deux fois sur la touche .
2. Appuyez sur la touche  pour sélectionner l'option "MODIFIER".
3. Confirmez avec la touche  et sélectionnez l'enregistrement désiré en appuyant sur la touche  ou .

**Remarque :** Pour sélectionner directement un enregistrement, appuyez sur la touche qui correspond à la première lettre de l'enregistrement. Pour accéder directement au nom "Peter", appuyez une fois sur la touche "7".

4. Confirmez avec la touche  et modifiez, le cas échéant, le nom affiché, le numéro d'appel et la mélodie. Confirmez chaque modification en appuyant sur la touche .

#### 8.3 Suppression d'enregistrements sauvegardés dans le répertoire

1. Appuyez deux fois sur la touche .
2. Appuyez sur la touche  pour sélectionner l'option "SUPPRIMER".
3. Confirmez avec la touche  et sélectionnez l'enregistrement désiré en appuyant sur la touche  ou .

**Remarque :** En appuyant sur la touche , vous interrompez l'opération de suppression.

4. Confirmez la suppression en appuyant deux fois sur la touche .

## - Affichage du numéro d'appel (CLIP) -

### 9 Affichage du numéro d'appel (CLIP) -

Si vous disposez de l'affichage du numéro d'appel, l'écran vous indique le numéro d'appel du correspondant à l'arrivée de l'appel. Si vous avez enregistré ce numéro d'appel dans votre répertoire, le nom sera affiché.

Si le correspondant a bloqué la transmission de son numéro d'appel, le numéro d'appel ne s'affichera pas. Le message "SECRET" apparaîtra à l'écran.

40 numéros d'appel en tout peuvent être enregistrés dans le journal des appels si bien que vous ne manquez aucun appel, même pendant votre absence. Si la liste est pleine, c'est toujours le numéro d'appel le plus ancien qui est supprimé. Si, pendant votre absence, de nouveaux numéros d'appel sont enregistrés dans le journal des appels, le symbole  apparaît à l'écran.







**Attention :** L'affichage du numéro d'appel (CLIP) ainsi que l'affichage de la date et de l'heure sont des services optionnels de votre exploitant de réseau. Veuillez demander de plus amples informations à votre exploitant de réseau.



#### 9.1 Le journal des appels

##### 9.1.1 Sélection des numéros d'appel du journal des appels

Pour voir à l'écran les numéros d'appel du journal des appels, veuillez procéder comme suit :

1. Appuyez sur la touche . Le numéro d'appel reçu en dernier apparaît à l'écran. Si le journal des appels est vide, l'écran affiche le message "VIDE".
2. La touche  ou  vous permet de composer d'autres numéros d'appel issus du journal des appels. S'il n'existe pas d'autres numéros d'appel, vous entendez un signal sonore. Deux symboles à l'écran vous informent si l'enregistrement dans le journal des appels a déjà été regardé ou si l'enregistrement dans le journal des appels est nouveau.

Ecran	Description
	Le numéro d'appel a déjà été regardé.
	Le numéro d'appel n'a pas encore été regardé.

3. Pour rappeler directement un numéro d'appel affiché, issu du journal des appels, appuyez sur la touche .
4. En appuyant sur la touche , vous quittez le journal des appels.

**Remarque :** En appuyant sur la touche , vous obtenez des information relatives au numéro d'appel affiché :

- Si le numéro d'appel est supérieur à 12 positions, les chiffres restants seront affichés.
- Affiche le numéro d'appel quand le correspondant est déjà enregistré avec son nom dans le répertoire.
- Indique la date et l'heure auxquelles ces données ont été transférées par le correspondant.





##### 9.1.2 Enregistrement des numéros d'appel issus du journal des appels dans le répertoire

Un numéro d'appel enregistré dans le journal des appels peut être enregistré directement dans le répertoire.

1. Appuyez sur la touche  et sélectionnez avec  ou  le numéro d'appel désiré. Confirmez la sélection en appuyant deux fois sur la touche .
2. Saisissez le nom désiré. Confirmez la saisie en appuyant sur la touche .

**Remarque :** Pour la saisie du nom, voir au chapitre 8.1.2.



**Remarque :** Si le nom est déjà enregistré dans le répertoire, un signal se fait entendre et le numéro d'appel sélectionné apparaît de nouveau à l'écran.

3. Le numéro d'appel apparaît encore une fois à l'écran. Confirmez en appuyant sur la touche .
4. Sélectionnez la mélodie désirée en appuyant sur la touche  ou  et confirmez avec la touche .



##### 9.1.3 Suppression individuelle de numéros d'appel issus du journal des appels

1. Appuyez sur la touche  et sélectionnez avec  ou  le numéro d'appel désiré.

**Remarque :** En appuyant sur la touche , vous interrompez l'opération de suppression.



2. Appuyez sur la touche . Confirmez la suppression en appuyant sur la touche .

##### 9.1.4 Suppression de tous les numéros d'appel du journal des appels







1. Appuyez sur la touche .
2. Appuyez sur la touche  pendant 3 secondes. Confirmez la suppression en appuyant sur la touche .

## 10 Fonctions spéciales









Vous avez la possibilité d'adapter à vos besoins quelques réglages effectués sur le combiné et sur la base. A cet effet, tenir compte du fait suivant :

- Si vous vous trouvez dans le menu, le symbole ⇄ apparaît à l'écran.
- En appuyant sur la touche , vous retournez à un niveau de menu inférieur.  
En appuyant longtemps sur la touche , vous interrompez l'opération à chaque endroit du menu. Le combiné retourne à l'état de repos.
- Chaque opération est automatiquement interrompue si vous n'effectuez pas de saisie dans les 20 secondes.









### 10.1 Réglage du volume sonore de la base

1. Appuyez sur la touche  et sélectionnez l'option "REGLAGES" avec la touche .
2. Confirmez avec la touche . L'écran affiche "VOLUME BASE".
3. Confirmez avec la touche  et sélectionnez le volume sonore désiré en appuyant sur la touche  ou .
4. Confirmez avec la touche .









### 10.2 Réglage de la mélodie de la base

1. Appuyez sur la touche  et sélectionnez l'option "REGLAGES" avec la touche .
2. Confirmez avec la touche  et sélectionnez l'option "MELODIE BASE" en appuyant sur la touche .
3. Confirmez avec la touche  et sélectionnez la mélodie désirée en appuyant sur la touche  ou .
4. Confirmez avec la touche .

### 10.3 Modification du code PIN









1. Appuyez sur la touche  et sélectionnez l'option "REGLAGES" avec la touche .
2. Confirmez avec la touche  et sélectionnez l'option "CODE PIN" en appuyant sur la touche .
3. Confirmez avec la touche  , saisissez le code PIN à quatre positions (réglage usine "0000") et confirmez avec .
4. Saisissez le nouveau code PIN à quatre positions et confirmez avec .
5. Saisissez encore une fois le nouveau code PIN et confirmez avec .

### 10.4 Numérotation par tonalité (Tone) ou par impulsions (Pulse)

1. Appuyez sur la touche  et sélectionnez l'option "REGLAGES" avec la touche .
2. Confirmez avec la touche  et sélectionnez l'option "NUMEROTATION" en appuyant sur la touche .
3. Confirmez avec la touche  et sélectionnez la numérotation désirée en appuyant sur la touche  ou .
4. Confirmez avec la touche .

### 10.5 Programmation du temps de flash

Vous pouvez régler deux temps de flash. Flash 1 correspond à 100 ms et Flash 2 correspond à 300 ms.

1. Appuyez sur la touche  et sélectionnez l'option "REGLAGES" avec la touche .
2. Confirmez avec la touche  et sélectionnez l'option "TOUCHE R" en appuyant sur la touche .
3. Confirmez avec la touche  et sélectionnez le temps de flash désiré en appuyant sur la touche  ou .
4. Confirmez avec la touche .

## - Fonctions spéciales -







### 10.6 Restauration des réglages usines

Cette fonction permet de remettre le combiné et la base en réglages usine.

**Réglages usine :**

Langue : français	Nom du combiné : DSPG
Signal d'avertissement des piles rechargeables : activé	Prise d'appel automatique : activé
Signal d'avertissement de la portée : activé	Mélodie de sonnerie externe : 3
Clic de touche : activé	Mélodie de sonnerie interne : 1
Volume sonore de l'écouteur : 3	Volume de la sonnerie du combiné : 3
Code PIN : 0000	Mélodie de la sonnerie de la base : 2
Pause : 3 secondes	Volume de la sonnerie de la base : 3
Numérotation : Tonalité/Tone	Temps de flash : 100 ms











**Remarque :** Le répertoire, le journal des appels (CLIP) et tous les numéros d'appel de la répétition automatique des derniers numéros sont effacés.

1. Appuyez sur la touche  et sélectionnez l'option "REGLAGES" avec la touche .
2. Confirmez avec la touche  et sélectionnez l'option "REGL DEF AUT" en appuyant sur la touche .
3. Confirmez avec la touche  et saisissez le code PIN à quatre positions (réglage usine "0000").
4. Confirmez en appuyant deux fois sur la touche .  
Le téléphone est de nouveau en réglage usine.

### 10.7 Activation / désactivation du son des touches et des signaux sonores d'avertissement

Vous pouvez activer ou désactiver différents sons.









- **Son des touches**  
Chaque actionnement de touche sur le combiné est confirmé par un son.
- **Signal sonore d'avertissement "Batt faible"**  
Quand la capacité des piles rechargeables est trop faible, un signal sonore d'avertissement vous rappelle que le combiné doit être rechargé.
- **Avertissement de dépassement de la portée**  
Si vous vous êtes trop éloigné de la base, un signal sonore d'avertissement se fait entendre.

1. Appuyez sur la touche  et sélectionnez l'option "COMBINE" avec la touche .
2. Confirmez avec la touche . L'écran affiche "BIPS".
3. Confirmez avec la touche  et sélectionnez avec la touche  ou  une des options "HORS PORTEE", "BIP TOUCHE" ou "BATT FAIBLE".
4. Confirmez avec la touche  et sélectionnez l'option "ACTIVE" ou "DESACTIVE" en appuyant sur la touche  ou .
5. Confirmez avec la touche .

### 10.8 Réglage du volume sonore du combiné









Le volume de la sonnerie peut être réglé sur différents niveaux ou être entièrement désactivé. Si la sonnerie est désactivée, les appels entrants seront signalés sur la base et sur l'écran du combiné.

Vous pouvez attribuer plusieurs volumes sonores selon que l'appel est interne ou externe.

1. Appuyez sur la touche  et sélectionnez l'option "COMBINE" avec la touche .
2. Confirmez avec la touche  et sélectionnez l'option "VOL SON INT" ou "VOL SON EXT" avec la touche .
3. Confirmez avec la touche  et sélectionnez le volume sonore désiré en appuyant sur la touche  ou .
4. Confirmez avec la touche .







### 10.9 Réglage de la mélodie de la sonnerie du combiné

Vous pouvez attribuer plusieurs mélodies selon que l'appel est interne ou externe.

1. Appuyez sur la touche  et sélectionnez l'option "COMBINE" avec la touche .
2. Confirmez avec la touche  et sélectionnez l'option "MELODIE INT" ou "MELODIE EXT" avec la touche .
3. Confirmez avec la touche  et sélectionnez la mélodie désirée en appuyant sur la touche  ou .
4. Confirmez avec la touche .

## - Fonctions spéciales -







### 10.10 Réglage de l'heure

1. Appuyez sur la touche  et sélectionnez l'option "COMBINE" avec la touche .
2. Confirmez avec la touche  et sélectionnez l'option "REG HEURE" en appuyant sur la touche .
3. Confirmez avec la touche  et saisissez l'heure actuelle en format horaire de 24 heures par l'intermédiaire du clavier.  
Exemple : 17:53 heures => 1753 ou 6:47 heures => 0647
4. Confirmez avec la touche .



### 10.11 Activation/désactivation de l'alarme

**Remarque :** La sonnerie d'alarme ne se fait entendre que sur le combiné, pas sur la base.

La sonnerie d'alarme se fait également entendre quand le volume de la sonnerie du combiné est désactivé.









1. Appuyez sur la touche  et sélectionnez l'option "COMBINE" avec la touche .
2. Confirmez avec la touche  et sélectionnez l'option "REG ALARME" en appuyant sur la touche .
3. Confirmez avec la touche  et sélectionnez l'option "ACTICVE" en appuyant sur la touche  ou .

**Remarque :** Si vous désirez désactiver l'alarme, sélectionnez l'option au point 4 "DEACTIVE" et confirmez avec la touche .

4. Confirmez avec la touche  et saisissez l'heure de réveil désirée en format horaire de 24 heures.
5. Confirmez avec la touche . L'alarme est maintenant activée.





### 10.12 Prise automatique d'appels

Si vous prenez le combiné de la base, les appels entrants seront automatiquement pris. Si vous désirez que les appels soient pris par l'actionnement de la touche , désactivez la prise automatique d'appel.

1. Appuyez sur la touche  et sélectionnez l'option "COMBINE" avec la touche .
2. Confirmez avec la touche  et sélectionnez l'option "REPONSE AUTO" en appuyant sur la touche .
3. Confirmez avec la touche  et sélectionnez l'option "ACTIVE" ou "DEACTIVE" en appuyant sur la touche  ou .
4. Confirmez avec la touche .

### 10.13 Modification du nom du combiné

Quand vous avez terminé une communication, la durée de la communication ainsi que le nom du combiné apparaissent en alternance à l'écran. Si plusieurs combinés ont été déclarés sur la base, il est judicieux de donner un nom particulier à chaque combiné.









1. Appuyez sur la touche  et sélectionnez l'option "COMBINE" avec la touche .
2. Confirmez avec la touche  et sélectionnez l'option "NOM" en appuyant sur la touche .
3. Confirmez avec la touche  et saisissez le nom désiré (10 caractères max.).

**Remarque :** Pour la saisie de texte, voir au chapitre 8.1.2.

4. Confirmez avec la touche .

### 10.14 Réglage de la langue

Vous pouvez faire afficher les textes de menu dans différentes langues.

1. Appuyez sur la touche  et sélectionnez l'option "COMBINE" avec la touche .
2. Confirmez avec la touche  et sélectionnez l'option "LANGUE" en appuyant sur la touche .
3. Confirmez avec la touche  et sélectionnez la langue désirée en appuyant sur la touche  ou .
4. Confirmez avec la touche .

## **11 Plusieurs combinés**

Vous pouvez déclarer cinq combinés sur votre base. Chaque combiné ne peut être inscrit simultanément que sur une base.

**Remarque :** Par l'intermédiaire du GAP standard normé international, il est possible d'intégrer les combinés SWITEL ainsi que les combinés d'autres fabricants dans le système téléphonique. De même, vous pouvez inscrire un combiné SWITEL sur des bases d'autres fabricants dans la mesure où ces appareils travaillent d'après le GAP standard.

Dans le cas d'utilisation de plusieurs combinés, vous avez les possibilités suivantes :

- Communications internes entre les combinés
- Les communications externes peuvent être transférées d'un combiné à l'autre.
- Les communications externes qui vous parviennent sont signalées à tous les combinés.
- Conférence avec un téléphone externe et deux téléphones internes.

**Remarque :** Si un autre combiné utilise déjà la ligne externe, le symbole EXT apparaît alors sur l'écran. Une autre communication externe n'est pas possible.

### **11.1 Téléphoner à l'intérieur**

Si vous avez déclaré plusieurs combinés sur la base, vous pouvez passer gratuitement des communications internes.

1. Appuyez sur la touche **[INT]** et composez le numéro interne du combiné, par ex. le "2".
2. La communication est reçue par le combiné appelé.

**Remarque :** Si un appel externe vous parvient pendant une communication interne, vous entendez de cours signaux sonores et vous voyez à l'écran le numéro d'appel du correspondant si celui-ci est disponible.

3. Terminez la communication interne en appuyant sur la touche **[ ]**.
4. Appuyez de nouveau sur la touche **[ ]** pour prendre l'appel externe.

### **11.2 Transfert de communications externes à un autre combiné**

Si vous avez pris une communication externe sur un combiné, vous pouvez transférer la communication externe sur un autre combiné.

Appuyez pour cela sur la touche **[INT]** puis composez le numéro interne du combiné désiré, par ex. le "2".

**Remarque :** Si le combiné appelé ne réagit pas, vous pouvez reprendre la communication en appuyant sur la touche **[INT]**.

Après que la communication interne a été prise par l'autre combiné, vous avez les possibilités suivantes :

1. **L'intercommunication / le va-et-vient :** Vous pouvez maintenant parler avec le correspondant interne et revenir au correspondant externe en appuyant sur la touche **[INT]**. Vous pouvez passer aussi souvent que vous le désirez de la communication externe à la communication interne.
2. **Transfert de la communication :** En appuyant sur la touche **[ ]** du premier combiné, la communication externe est transférée au combiné appelé.

### **11.3 Téléphoner en conférence**

Une communication externe peut être branchée sur un autre correspondant interne dans le but de mener une conférence. Ainsi, deux combinés peuvent parler simultanément avec le correspondant externe.

1. Etablissez la liaison désirée avec le correspondant externe.
2. Appuyez pour cela sur la touche **[INT]** puis composez le numéro interne du deuxième combiné désiré.
3. Quand le deuxième correspondant interne a pris la communication, appuyez sur la touche **[ ]** et les trois correspondants sont branchés en conférence.

**Remarque :** Pendant une conférence, vous pouvez mettre le correspondant externe en attente en appuyant sur la touche **[INT]**. En appuyant successivement sur les touches **[INT]** et **[ ]**, vous repassez en conférence.

4. La conférence est terminée lorsqu'un des correspondants internes repose l'appareil.

## - Plusieurs combinés -

### 11.4 Déclaration et annulation de combinés

#### 11.4.1 Déclaration de combinés

1. Appuyez sur la touche de paging (☎) de la base pendant trois secondes jusqu'à ce que vous entendiez deux signaux sonores. Déclarez maintenant le nouveau combiné dans les 90 secondes.
2. Appuyez sur la touche [☰] du combiné et sélectionnez l'option "DECLARER" avec la touche [▼].
3. Confirmez avec la touche [☰] et sélectionnez l'option "DECL. BASE" en appuyant sur la touche [▲] ou [▼].
4. Confirmez avec la touche [☰] et saisissez le numéro de la base par l'intermédiaire du pavé numérique (1 à 4). Si le combiné est déjà relié à une base, les numéros correspondants clignotent.
5. Confirmez avec la touche [☰]. La base est recherchée.
6. Après que la base a été trouvée, vous devez saisir le code PIN (réglage usine 0 0 0 0).
7. Confirmez avec la touche [☰]. Au bout de quelques secondes, vous entendez un signal sonore. Le combiné est maintenant déclaré et peut être utilisé pour des communications externes et internes.

**Remarque :** Un numéro d'appel interne est attribué au combiné. Le combiné déjà déclaré possède le numéro d'appel interne 1. Le deuxième combiné déjà déclaré reçoit le numéro d'appel interne 2. Ce numéro d'appel interne est affiché à droite sur l'écran.

#### 11.4.2 Déclaration d'autres téléphones DECT-GAP sur la base

Pour déclarer un combiné DECT-GAP d'un autre fabricant, suivez les instructions contenues dans le mode d'emploi de l'autre fabricant et appuyez alors pendant 3 secondes sur la touche de paging (☎) de votre base. Utilisez le code PIN pour la déclaration (réglage usine: 0000).

#### 11.4.3 Annulation des combinés

Un combiné ne peut être annulé que par l'intermédiaire d'un autre combiné encore déclaré. Il n'est pas possible d'exécuter cette suppression avec le combiné qui doit être annulé.

1. Appuyez sur la touche [☰] et sélectionnez l'option "REGLAGES" avec la touche [▼].
2. Confirmez avec la touche [☰] et sélectionnez l'option "SUPP COMBINE" en appuyant sur la touche [▲] ou [▼].
3. Confirmez avec la touche [☰] et saisissez le code PIN par l'intermédiaire du pavé numérique (réglage usine : 0000).

**Remarque :** Interrompez l'opération avec la touche [☰].

4. Confirmez avec la touche [☰] et saisissez le numéro interne du combiné à supprimer.
5. Si l'annulation a réussi, vous entendez un signal sonore au bout de quelques secondes. Le combiné est maintenant annulé et ne peut plus être utilisé pour des communications externes et internes.

### 11.5 Bases supplémentaires

Si vous utilisez plusieurs bases, vous pouvez augmenter la portée du combiné. Pour tirer parti de cet effet, toutes les bases doivent être raccordées à un même raccordement téléphonique. Selon l'objectif d'utilisation, vous pouvez attribuer à chaque base le même numéro de téléphone ou leur donner des numéros d'appel différents. Veillez à ce que toutes les portées des bases se recoupent. Le combiné doit être déclaré sur chaque base. Veuillez tester la portée du combiné avant la mise en service d'une nouvelle base.

Si un combiné est déclaré sur les bases et que le choix automatique de base est activé sur le combiné (voir 11.5.1), celui-ci sera toujours automatiquement transféré à la prochaine base.

#### 11.5.1 Sélection d'une base

1. Appuyez sur la touche [☰] du combiné et sélectionnez l'option [▼] "DECLARER" avec la touche.
2. Confirmez avec la touche [☰] et sélectionnez l'option "CHOIX BASE" en appuyant sur la touche [▲] ou [▼].
3. Confirmez avec la touche [☰]. Toutes les bases sur lesquelles le combiné est déjà déclaré apparaissent à l'écran. Le numéro de la base active clignote. Sélectionnez, par l'intermédiaire du pavé numérique, la base désirée sur laquelle le combiné doit être réglé.  
Ou passez sur l'option "AUTO" en appuyant sur la touche [▼]. Dans ce mode de réglage, le combiné passe automatiquement sur la prochaine base quand la liaison téléphonique avec la base actuelle s'interrompt.



## - Elimination des perturbations -

### 12 Elimination des perturbations

Si vous avez des problèmes avec votre téléphone, contrôlez tout d'abord les indications suivantes sur votre appareil. En ce qui concerne le droit à la garantie, veuillez vous adresser à votre revendeur.

Erreurs	Solutions
Pas de communication téléphonique possible	<ul style="list-style-type: none"><li>- Le câble du téléphone n'est pas correctement branché ou est soumis à des perturbations. N'utilisez que le câble téléphonique fourni avec l'appareil.</li><li>- Testez avec un autre téléphone si votre raccordement téléphonique fonctionne.</li><li>- Le bloc d'alimentation enfichable n'est pas branché ou il y a une panne totale de courant.</li><li>- Les piles rechargeables standard sont vides ou défectueuses.</li><li>- Vous vous êtes trop éloigné de la base.</li></ul>
La liaison est hachée, est coupée	<ul style="list-style-type: none"><li>- Vous vous êtes trop éloigné de la base.</li><li>- Mauvais lieu d'installation de la base.</li></ul>
Pas de numérotation possible	<ul style="list-style-type: none"><li>- Le système de numérotation est mal réglé (voir chapitre 10.4).</li></ul>
Le système ne réagit plus ou se trouve dans un état indéfini	<ul style="list-style-type: none"><li>- Rétablissez les réglages usine (voir chapitre 10.6). Retirez tout d'abord temporairement le bloc d'alimentation de la prise secteur.</li></ul>
Le voyant du contrôle de charge n'est pas allumé	<ul style="list-style-type: none"><li>- Placez le combiné correctement sur la base, nettoyez les surfaces de contact du combiné et de la base avec un chiffon sec et doux.</li></ul>
Au bout de quelques heures, le symbole de la pile clignote à l'écran	<ul style="list-style-type: none"><li>- Posez le combiné sur la base et laissez-le pendant 14 heures . Si cela ne sert à rien, renouvelez les piles rechargeables standard.</li></ul>
L'affichage de l'écran est sombre	<ul style="list-style-type: none"><li>- Provient de l'ensoleillement direct, faire refroidir le combiné.</li></ul>

## - Informations importantes -

### 13 Informations importantes

#### 13.1 Données techniques

Caractéristique	Valeur
Standard	DECT-GAP
Alimentation en courant	Base 220/230 V, 50 Hz
Portée (à l'extérieur / à l'intérieur)	300 m / 50 m
Etat de veille	jusqu'à 110 h
Durée max. de communication	jusqu'à 10 h
Piles rechargeables standard	2 x AAA (1.2V / 550 mAh)
Numérotation	Tone ou Pulse
Température ambiante autorisée	10°C à 30°C
Humidité atmosphérique relative autorisée	20% à 75%
Temps de flasch	100 ms ou 300 ms

DECT: **D**igital **E**uropean **C**ordless **T**elephone = Standard pour téléphones sans fil.

GAP : **G**eneric **A**ccess **P**rofile = Standard pour l'action conjointe de combinés et de bases de fabricants différents.

#### 13.2 Garantie

Les appareils Switel sont fabriqués et testés selon les procédés de production les plus modernes. Les matériaux choisis et la haute technologie assure un fonctionnement parfait et une longue durée de vie. La garantie ne rentre pas en jeu si l'exploitant du réseau téléphonique ou une installation à postes supplémentaires éventuellement intercalée est responsable du disfonctionnement de l'appareil. La garantie ne s'applique pas aux piles rechargeables standard ou aux packs de piles rechargeables utilisés dans le produit. La durée de garantie est de 24 mois à partir de la date d'achat.

Pendant la période de la garantie, tous les défauts dus à des erreurs de matériel et de fabrication sont réparés gratuitement. La garantie expire en cas d'interventions de l'acheteur ou d'un tiers. Les dommages engendrés par une manipulation ou une utilisation inadéquates, par un mauvais emplacement ou rangement, par un raccordement ou une installation inadéquate ainsi que par un cas de force majeure ou d'autres influences extérieures ne sont pas inclus dans la prestation de la garantie. En cas de réclamations, nous nous réservons le droit de réparer ou de remplacer les pièces défectueuses ou d'échanger l'appareil. Les pièces ou appareils échangés deviennent notre propriété. Le droit de réclamer des dédommagements est exclu sauf si ce dommage est basé sur une préméditation ou une négligence grave du fabricant.

Si votre appareil devait cependant comporter un défaut pendant la période de garantie, veuillez vous adresser exclusivement au magasin dans lequel vous avez acheté votre appareil en présentant votre bon d'achat. Tous les droits de garantie basés sur ces dispositions ne peuvent être réclamés qu'auprès de votre revendeur. A l'échéance des deux ans après l'achat et le transfert de nos produits, les législations en matière de garantie ne sont plus applicables.

<b>1</b>	<b>Indicazioni generali</b> .....	<b>45</b>
1.1	Utilizzo conforme alle disposizioni .....	45
1.2	Caduta di tensione .....	45
1.3	Luogo di installazione .....	45
1.4	Alimentatore di rete .....	45
1.5	Batterie standard ricaricabili .....	45
1.6	Caricare l'unità portatile .....	45
1.7	Impianti telefonici interni .....	45
1.8	Avvertenze riguardo lo smaltimento .....	45
1.9	Avvertenza per apparecchiature mediche .....	45
1.10	Temperatura e ambiente circostante .....	46
1.11	Pulizia e cura .....	46
<b>2</b>	<b>Caratteristiche funzionali</b> .....	<b>46</b>
2.1	Telefono .....	46
<b>3</b>	<b>Elementi di comando</b> .....	<b>47</b>
3.1	Unità portatile .....	47
3.2	Stazione base .....	47
<b>4</b>	<b>Impianti telefonici interni / Servizi aggiuntivi</b> .....	<b>48</b>
4.1	Tasto R in impianti telefonici interni .....	48
4.2	Tasto R e i servizi aggiuntivi della SWISSCOM .....	48
4.3	Pausa di selezione .....	48
<b>5</b>	<b>Messa in funzione</b> .....	<b>49</b>
5.1	Indicazioni di sicurezza .....	49
5.2	Verificare il contenuto della confezione .....	49
5.3	Collegare la stazione base .....	49
5.4	Inserire le batterie standard ricaricabili .....	49
5.5	Caricare le batterie standard ricaricabili .....	49
5.6	Procedura di selezione a TONI (PST) o a IMPULSI (PSI) .....	49
<b>6</b>	<b>Struttura di menu</b> .....	<b>50</b>
<b>7</b>	<b>Esercizio</b> .....	<b>52</b>
7.1	Il display .....	52
7.2	Segreteria telefonica esterna .....	52
7.3	Ricevere chiamate .....	52
7.4	Ricevere due chiamate .....	52
7.5	Condurre telefonate .....	52
7.6	Selezionare numeri di chiamata memorizzati nella rubrica telefonica .....	53
7.7	Visualizzazione della durata di chiamata .....	53
7.8	Attivare/Disattivare l'unità portatile .....	53
7.9	Impostare il volume del ricevitore .....	53
7.10	Ripetizione di chiamata .....	53
7.10.1	Cancellare un numero di chiamata dall'elenco di ripetizione di chiamata .....	53
7.11	Silenziamento del microfono nell'unità portatile .....	53
7.12	Attivare/Disattivare il blocco tastiera .....	53
7.13	Selezione a toni temporanea .....	53
7.14	Avvertenza riguardo la distanza .....	53
7.15	Ricerca di unità portatile (tasto di paging) .....	53
<b>8</b>	<b>La rubrica telefonica</b> .....	<b>54</b>
8.1	Immettere numero di chiamata nella rubrica telefonica .....	54
8.1.1	Avvertenze riguardo la rubrica telefonica .....	54
8.1.2	Immissione di testo .....	54
8.2	Modificare voci memorizzate nella rubrica telefonica .....	54
8.3	Cancellare voci memorizzate dalla rubrica telefonica .....	54

**- Indice -**

<b>9</b>	<b>Visualizzazione del numero di chiamata (CLIP)</b> .....	<b>55</b>
9.1	L'elenco chiamate .....	55
9.1.1	Selezionare il numero di chiamata dall'elenco chiamate .....	55
9.1.2	Memorizzare un numero di chiamata dall'elenco chiamate nella rubrica telefonica .....	55
9.1.3	Cancellare singoli numeri di chiamata dall'elenco chiamate .....	55
9.1.4	Cancellare tutti i numeri di chiamata dall'elenco chiamate .....	55
<b>10</b>	<b>Funzioni speciali</b> .....	<b>56</b>
10.1	Impostare il volume della base .....	56
10.2	Impostare la melodia di base .....	56
10.3	Modificare il PIN .....	56
10.4	Procedura di selezione a TONI (PST) o a IMPULSI (PSI) .....	56
10.5	Impostare il tempo flash .....	56
10.6	Ripristinare le impostazioni di default .....	57
10.7	Attivare/Disattivare il suono tasti e le segnalazioni acustiche .....	57
10.8	Impostare il volume della suoneria di chiamata dell'unità portatile .....	57
10.9	Impostare la melodia di suoneria dell'unità portatile .....	57
10.10	Impostare l'orario .....	58
10.11	Sveglia ON/OFF .....	58
10.12	Accettare le chiamate automaticamente .....	58
10.13	Modificare il nome dell'unità portatile .....	58
10.14	Impostare la lingua .....	58
<b>11</b>	<b>Maggior numero di unità portatili</b> .....	<b>59</b>
11.1	Telefonate interne .....	59
11.2	Trasferimento di chiamate esterne ad un'altra unità portatile .....	59
11.3	Condurre chiamate a conferenza .....	59
11.4	Selezione e deselegione di unità portatili .....	60
11.4.1	Selezione di unità portatili .....	60
11.4.2	Selezione di altri telefoni DECT-GAP sulla stazione base .....	60
11.4.3	Deselegione di unità portatili .....	60
11.5	Stazioni base addizionali .....	60
11.5.1	Selezione di una stazione base .....	60
<b>12</b>	<b>Eliminazione di errori</b> .....	<b>61</b>
<b>13</b>	<b>Informazioni importanti</b> .....	<b>62</b>
13.1	Dati tecnici .....	62
13.2	Garanzia .....	62

## - Indicazioni generali -

### 1 Indicazioni generali

Si prega di leggere attentamente le presenti istruzioni per l'uso. Non aprire per nessuna ragione l'apparecchio autonomamente e svolgere riparazioni di propria iniziativa. In caso di reclami entro il periodo di garanzia si prega di rivolgersi al rivenditore autorizzato. Con riserva di modifiche tecniche ed ottiche dell'articolo dovute a migliorie di sviluppo.

#### 1.1 Utilizzo conforme alle disposizioni

Il presente telefono è stato sviluppato per l'esercizio con un allacciamento telefonico di accesso analogico (PSTN) entro i confini della Svizzera. Ciò nonostante, in particolare a causa di possibili differenze tra i vari gestori di telecomunicazione, non è possibile assumere alcuna garanzia riguardo il perfetto funzionamento dell'apparecchio terminale per tutti gli allacciamenti di telecomunicazione. Collegare il cavo di allacciamento del telefono soltanto in un'apposita presa telefonica. Non sostituire il connettore del cavo di allacciamento.

#### 1.2 Caduta di tensione

In caso di caduta di tensione non è possibile impiegare il telefono per telefonare. Si consiglia pertanto di tenere a portata di mano in caso di emergenza un telefono con filo in grado di funzionare anche senza alimentazione elettrica esterna.

#### 1.3 Luogo di installazione

Il luogo di installazione influenza decisamente il corretto funzionamento del telefono. Sul luogo di installazione è necessaria la presenza di una presa elettrica da 230 Volt.

Non posizionare la stazione base nelle dirette vicinanze di altri apparecchi elettronici come per es. forni a microonde o impianti HIFI, condizione che può invece causare un'influenza reciproca. Mantenere una distanza minima di un metro da altri apparecchi elettronici. Posizionare la stazione base su una superficie piana e antiscivolo. In linea di massima, i piedini della stazione base non lasciano tracce sulla superficie di appoggio. A causa del numero crescente di vernici e superfici diverse non è comunque possibile escludere che i piedini dell'apparecchio possano lasciare delle tracce sulla superficie di appoggio.

#### 1.4 Alimentatore di rete

Utilizzare esclusivamente l'alimentatore a spina SWITEL fornito in dotazione visto che altri alimentatori di rete potrebbero addirittura danneggiare il telefono. Non aprire l'alimentatore di rete. Pericolo di vita in caso di apertura dell'alimentatore di rete fino a quando questo è ancora collegato alla rete elettrica.

#### 1.5 Batterie standard ricaricabili

Utilizzare le batterie standard ricaricabili fornite in dotazione. Utilizzare quindi in caso di sostituzione sempre batterie standard ricaricabili del tipo AAA 1,2V 550mAh. L'uso di batterie standard o accumulatori differenti può essere causa di corto circuiti. Non gettare le batterie standard ricaricabili nel fuoco, né sommergerle in acqua. Le durate di stand-by e di autonomia massima indicate si riferiscono all'impiego delle batterie standard ricaricabili fornite in dotazione in condizioni ottimali. Temperatura ambiente, ciclo di ricarica e altri fattori d'influsso esterni come per es. la sollecitazione di radiotrasmissione dell'ambiente circostante possono notevolmente ridurre la durata di impiego. La capacità di ricarica si riduce inoltre anche dal punto di vista tecnico nel corso della durata in vita oppure in seguito ad una conservazione in presenza di temperature particolarmente elevate o basse.

#### 1.6 Caricare l'unità portatile

L'unità portatile si surriscalda durante il processo di carica. Questo è un fenomeno normale e non pericoloso. Evitare di caricare l'unità portatile con caricatori estranei, cosa che potrebbe causare dei danni.

#### 1.7 Impianti telefonici interni

Il telefono è altresì collegabile ad un impianto telefonico interno. Il rivenditore specializzato è in grado di indicare se il telefono acquistato funzionerà senza alcun problema nel proprio impianto telefonico interno. **Non** è possibile garantire che il telefono acquistato funzioni in ogni caso con qualsiasi tipo di impianto telefonico interno.

#### 1.8 Avvertenze riguardo lo smaltimento

La conversione della legislazione europea in leggi e direttive nazionali impone il corretto smaltimento di beni di consumo. Questo avviene all'insegna della protezione di persone e ambiente.

Il simbolo raffigurato qui a lato indica, che apparecchi usati elettrici ed elettronici e batterie esauste non sono da smaltire assieme ai normali rifiuti domestici.

**Procedere pertanto allo smaltimento di apparecchi vecchi o esausti** presso un centro di raccolta incaricato con il rispettivo ed appropriato smaltimento.

Consegnare **batterie ed accumulatori** per lo smaltimento presso i rivenditori al dettaglio di batterie o i centri di raccolta che mettono a disposizione appositi contenitori.

Smaltire **confezioni ed imballaggi** in base a quanto indicato dalle norme in vigore a livello locale.

#### 1.9 Avvertenza per apparecchiature mediche

Il telefono funziona con una potenza di trasmissione molto bassa. Questa potenza di trasmissione ridotta esclude, tenuto conto dell'attuale stato di ricerca e sviluppo tecnologico, un'esposizione a rischi di salute. Si è comunque dimostrato che telefoni portatili in funzione sono in grado di influenzare apparecchiature mediche. Evitare pertanto di tenere il telefono nelle vicinanze di apparecchiature mediche. Un influsso su cardiostimolatori da parte di telefoni DECT non è stato finora osservato, sebbene non sia comunque possibile escludere completamente un simile rischio. Telefoni DECT possono causare un fastidioso ronzio in apparecchi acustici.



## - Indicazioni generali -

### 1.10 **Temperatura e ambiente circostante**

Il telefono è stato progettato per l'uso in ambienti chiusi e protetti con una temperatura compresa tra 10 °C e 30 °C. Si consiglia di evitare l'uso della stazione base in ambienti esposti a umidità come bagno e locali di lavaggio. Evitare peraltro anche la vicinanza a fonti di calore come termosifoni e non esporre l'apparecchio alla diretta irradiazione solare.

Evitare l'uso dell'unità portatile in aree esposte al rischio di deflagrazione.

Evitare pertanto un'esposizione a fumo, vibrazioni, sostanze chimiche, umidità, calore e raggi solari diretti.

### 1.11 **Pulizia e cura**

Pulire le superfici della custodia con un panno asciutto, morbido e antipilling. Non utilizzare mai detergenti o solventi aggressivi. Al di là di una pulizia di tanto in tanto della custodia esterna, non sono necessari ulteriori interventi di pulizia e cura. I piedini in gomma della stazione base non sono resistenti a qualsiasi detergente. Il costruttore non risponde pertanto di eventuali danni a mobili o simili.

## - Caratteristiche funzionali -

## 2 **Caratteristiche funzionali**

### 2.1 **Telefono**

- Standard DECT/GAP digitale
- Fino a 10 ore di autonomia di conversazione - fino a 110 ore di stand-by
- Codifica della parola per elevata sicurezza
- Selezione a toni / Selezione a impulsi (PST/PSI)
- Visualizzazione del numero di chiamata su display (CLIP)
- Elenco chiamate fino a 40 numeri di chiamata
- Ripetizione di chiamata degli ultimi 10 numeri di chiamata
- Rubrica telefonica per fino a 50 numeri di chiamata inclusi nomi
- Orologio 24 ore con funzione sveglia/allarme integrata nell'unità portatile
- Visualizzazione della durata di chiamata
- Espansione con altre unità portatili DECT con funzione GAP
- Esercizio multilink con fino a cinque unità portatili
- Chiamate interne gratuite tra due unità portatili
- Conferenze tra due unità portatili ed un interlocutore esterno
- Inoltro di chiamata tra le unità portatili
- Melodie di suoneria differenti impostabili per unità portatile e stazione base
- Chiamata VIP (attribuzione di melodia)
- Idoneo per i servizi addizionali della Swisscom (Hook flash) - Idoneo all'integrazione in impianti telefonici interni
- Silenziamento del microfono
- Blocco tastiera

DECT: **D**igital **E**uropean **C**ordless **T**elephone = Standard per telefoni senza cavo.

GAP: **G**eneric **A**ccess **P**rofile = Standard per l'interazione di unità portatili con stazioni base di altri costruttori.

## - Elementi di comando -

### 3 Elementi di comando

#### 3.1 Unità portatile

1. Visualizzazione di chiamata
2. Ripetizione di chiamata
3. Menu
4. Rubrica telefonica
5. Tasti di selezione / Elenco chiamate CLIP
6. Chiamate interne e conversazioni in conferenza
7. Tasto di segnalazione R / ON / OFF
8. Tasto di chiamata
9. Tasto di muting / Cancella

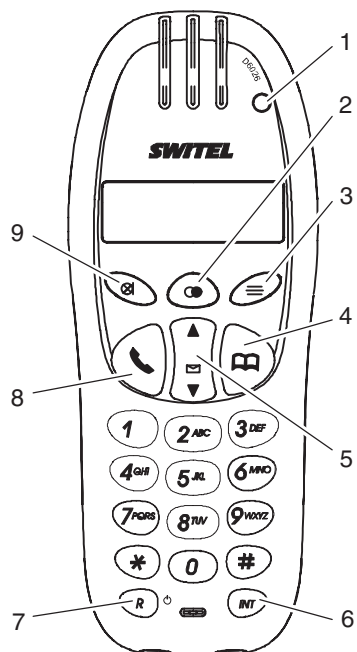

#### 3.2 Stazione base

10. Tasto di ricerca unità portatile (tasto di paging)
11. LED Visualizzazione chiamata e rete
12. LED Spia di controllo dello stato di carica

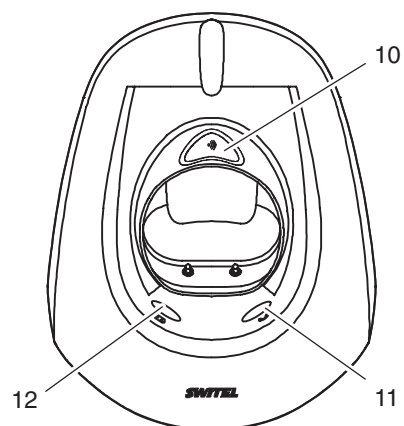

## **4 Impianti telefonici interni / Servizi aggiuntionali**

Il tasto "R" del telefono è disponibile in presenza di impianti telefonici interni oppure utilizzando i servizi a valore aggiunto del proprio gestore di rete telefonica.

### **4.1 Tasto R in impianti telefonici interni**

Avendo collegato il telefono ad un impianto telefonico interno, il tasto "R" consente di accedere a tutte le altre funzioni disponibili come per es. trasferimento di chiamata, funzione di richiamata automatica e così via. Un impianto telefonico interno richiede un tempo flash di 100 ms (per Impostazione vedi capitolo 10.5). Il rivenditore specializzato è in grado di indicare se il telefono acquistato funzionerà senza alcun problema nel proprio impianto telefonico interno.

### **4.2 Tasto R e i servizi a valore aggiunto del proprio gestore di rete telefonica**

Il telefono SWITEL supporta i più importanti servizi a valore aggiunto del proprio gestore di rete telefonica (per es. funzioni di chiamata in attesa, avviso di chiamata, conferenza a tre). Per accedere alle funzioni dei servizi a valore aggiunto del proprio gestore di rete telefonica è necessario impostare il tempo flash di 100 ms (per Impostazione vedi capitolo 10.5).

Si prega di rivolgersi direttamente al proprio gestore di rete telefonica per l'abilitazione ai servizi a valore aggiunto.

### **4.3 Pausa di selezione**

In presenza di impianti telefonici interni è necessario selezionare un determinato numero (per es. "9" o "0") prima di ottenere un segnale di libero che indica la disponibilità della linea di collegamento di rete. Alcuni impianti telefonici interni di vecchia data richiedono un intervallo di tempo di poco superiore prima di trasmettere un segnale di libero. In particolare, proprio per questi impianti telefonici interni è possibile prevedere, una volta ottenuta la linea di collegamento di rete, una pausa automatica che consente di comporre il numero di chiamata desiderato senza dover necessariamente attendere il segnale di libero.

Premere tra la cifra da digitare per ottenere un segnale di libero ed il numero di chiamata da comporre una volta il tasto . Sul display appare l'indicazione "P". In seguito alla disponibilità della linea di collegamento di rete, il telefono aspetta 3 secondi prima di procedere con la selezione del numero che si desidera chiamare.

**Avvertenza:** La pausa è anche programmabile in sede di immissione dei numeri di chiamata nella rubrica telefonica.



## - Messa in funzione -

### 5 Messa in funzione

#### 5.1 Indicazioni di sicurezza



**Attenzione:** Leggere assolutamente prima della messa in funzione le indicazioni generali riportate all'inizio delle presenti istruzioni per l'uso.

#### 5.2 Verificare il contenuto della confezione

La confezione contiene:

una stazione base	un cavo di collegamento telefonico
un'unità portatile	due batterie standard ricaricabili
un alimentatore di rete	un manuale di istruzioni per l'uso

#### 5.3 Collegare la stazione base

Posizionare la stazione base in prossimità della presa di collegamento telefonico e di una presa elettrica. Utilizzare soltanto i componenti forniti in dotazione.

1. Inserire il connettore piccolo dell'alimentatore di rete nella rispettiva presa presente sul lato inferiore della stazione base.

**Avvertenza:** E' impossibile collegare il connettore in maniera errata, visto che connettori e prese sono costruiti con una protezione integrata che consente di prevenire un'eventuale inversione delle polarità. I connettori devono incastrarsi in maniera udibile nelle rispettive prese della stazione base.

2. Inserire il connettore piccolo del cavo di collegamento telefonico nella rispettiva presa presente sul lato inferiore della stazione base.
3. Condurre i due cavi presenti sulla parte inferiore della stazione base nella canalina per cavi appositamente prevista lungo il retro.
4. Inserire l'alimentatore di rete in una presa elettrica da 230 Volt installata in conformità alle disposizioni. L'alimentatore di rete della stazione base deve essere sempre collegato.
5. Collegare il cavo telefonico fornito con il jack telefonico.

#### 5.4 Inserire le batterie standard ricaricabili

Al fine di inserire le batterie standard ricaricabili accluse all'interno dell'unità portatile, premere il coperchio del vano batterie sul bordo esterno e spingere contemporaneamente verso il basso. A questo punto inserire le batterie standard. Osservare la corretta polarità. Chiudere quindi il vano batterie.

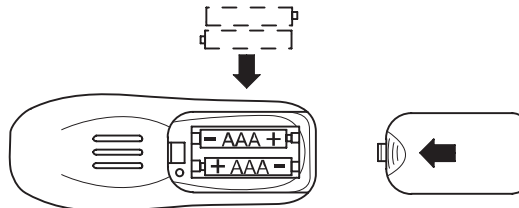

#### 5.5 Caricare le batterie standard ricaricabili

Inserire l'unità portatile con il display rivolto in avanti per una durata di minimo 14 ore nella stazione base. Presso la stazione base si accende la spia di controllo dello stato di carica. L'uso di batterie standard non ricaricate in maniera corretta può causare difetti o guasti al telefono. Le batterie standard ricaricabili dell'apparecchio portatile sono in grado di garantire una durata di stand-by di max. 110 ore in presenza di temperatura ambiente. La durata di autonomia massima è di 10 ore.

Lo stato di carica attuale è visualizzato sul display:

Carico	A metà	Debole	Scarico

#### 5.6 Procedura di selezione a TONI (PST) o a IMPULSI (PSI)

Questa funzionalità consente di utilizzare il telefono sia per collegamenti telefonici analogici (selezione a impulsi/PSI) sia per collegamenti digitali (selezione a toni/PST). L'impostazione di base compiuta in fabbrica per l'apparecchio prevede la procedura di selezione a TONI (PST). Nel caso di mancato funzionamento del telefono presso il collegamento telefonico disponibile, è ad ogni modo possibile passare alla procedura di selezione a IMPULSI (PSI) seguendo le indicazioni riportate nel capitolo 10.4.

**- Struttura di menu -**

**6      Struttura di menu**

Qui è riportata la struttura di menu del presente telefono. In stato di stand-by la selezione dei menu disponibili è realizzata premendo il tasto .

Rubrica	Aggiungere	Nome ?	Numero ?	Melodia 1-5
	Modificare			
	Cancellare			

Impostare	Volume base	Volume 1, 2, 3, 4, 5, Silenzio		
	Melodia base	Melodia 1, 2, 3, 4, 5		
	Canc port	PIN? (Impostazione di default 0000)		
	Codice PIN	PIN? (Impostazione di default 0000)	Nuovo PIN	Ripetere
	MF-DC	MF		
		DC		
	Tasto R	Flash 1		
		Flash 2		
	Config iniz	PIN? (Impostazione di default 0000)	OK ?	

**- Struttura di menu -**











Portatile	Bip	Bip tasti	Attivato - Disattivato
		Bat scarica	Attivato - Disattivato
		Fuori camp	Attivato - Disattivato
	Vol suon int	Volume 1, 2, 3, 4, 5, Silenzio	
	Vol suon est	Volume 1, 2, 3, 4, 5, Silenzio	
	Suoneria int	Melodia 1, 2, 3, 4, 5	
	Suoneria est	Melodia 1, 2, 3, 4, 5	
	Imposta ora	Orario attuale	
	Imp. allarme	Attivato - Disattivato	Orario sveglia
	Risp auto	Attivato - Disattivato	
	Nome	.....	
	Lingua	Deutsch	
		English	
		Francais	
	Italiano		
Blocco tast			

Registrare	Selez base	BS 1 _ _ _
		Auto
	Regist base	BS 1 2 3 4



## - Esercizio -

### 7 Esercizio

#### 7.1 Il display

Display	Descrizione
	<b>Costante:</b> Chiamata telefonica in corso.
EXT	<b>Costante:</b> Chiamata telefonica esterna in corso. <b>Lampeggia:</b> Chiamata telefonica esterna in arrivo.
	<b>Costante:</b> Chiamata telefonica interna in corso. <b>Lampeggia:</b> Chiamata telefonica interna in arrivo.
	<b>Costante:</b> Ci si trova nell'elenco chiamate. <b>Lampeggia:</b> Nuove chiamate nell'elenco chiamate.
	<b>Costante:</b> Il numero di chiamata indicato nell'elenco chiamate non è stato accettato.
	<b>Costante:</b> Il numero di chiamata indicato nell'elenco chiamate è stato accettato.
	<b>Lampeggia:</b> Caricare le batterie. <b>Costante:</b> Indicazione dello stato di carica delle batterie. <b>Segmenti scorrano:</b> Processo di carica delle batterie in corso.
	<b>Costante:</b> Ci si trova nella rubrica telefonica.
	<b>Costante:</b> La programmazione è attivata.
	<b>Costante:</b> Il blocco tastiera è attivato.
	<b>Costante:</b> Il collegamento con la stazione base è buono. <b>Lampeggia:</b> Superata la portata della stazione base.
	<b>Costante:</b> Il numero di chiamata è composto da più di 12 cifre.



#### 7.2 Segreteria telefonica esterna

Il simbolo  segnala la presenza di nuovi messaggi sulla segreteria telefonica esterna. La visualizzazione del simbolo  è possibile solo con un allacciamento telefonico digitale. Dopo aver ascoltato il messaggio, il simbolo scompare.



**Attenzione:** La segreteria telefonica esterna e la trasmissione del simbolo  sono servizi opzionali messi a disposizione dal gestore di rete telefonica. Si consiglia di rivolgersi al proprio gestore di rete telefonica per ricevere ulteriori informazioni a riguardo.

#### 7.3 Riceverechiamate

Una segnalazione acustica di chiamata presso unità portatile e stazione base indica una chiamata in arrivo. Estrarre quindi l'unità portatile dalla stazione base o premere il tasto di chiamata . Il collegamento è instaurato. Per concludere la telefonata riporre l'unità portatile nella stazione base o premere il tasto .

**Avvertenza:** Mentre l'unità portatile squilla, è possibile modificare l'impostazione del volume premendo i tasti  o .

#### 7.4 Ricevere due chiamate



Dei segnali acustici indicano (avviso di chiamata) la ricezione di un'ulteriore chiamata durante lo svolgimento della prima telefonata. Sul display viene visualizzato il numero del secondo chiamante. Con la sequenza di tasti "R" "2" è possibile passare da un interlocutore all'altro. Mentre è in corso la conversazione con un altro interlocutore, la chiamata è trattenuta.

**Avvertenza:** Per accedere ai servizi addizionali della SWISSCOM è necessario impostare il tempo flash di 300 ms (vedi capitolo 10.5).

**Avvertenza:** La visualizzazione del numero di chiamata e la funzione di avviso di chiamata sono dei servizi opzionali del rispettivo gestore della rete telefonica. Si consiglia di rivolgersi al proprio gestore di rete telefonica per ricevere ulteriori informazioni a riguardo.

#### 7.5 Condurre telefonate

1. Immettere il numero di chiamata (max. 32 cifre). Il display indica al massimo 12 caratteri. In presenza di numeri di chiamata più lunghi sono visualizzati solo gli ultimi 12 caratteri.

**Avvertenza:** Premendo brevemente il tasto  si cancella l'ultima cifra immessa erroneamente. Premendo a lungo il tasto  viene cancellato l'intero numero di chiamata.

2. Premere infine il tasto di chiamata  per procedere al collegamento.

**Avvertenza:** E' altresì possibile premere prima il tasto  e immettere quindi il numero di chiamata. Con questo tipo di composizione del numero di chiamata non è possibile compiere una correzione di singole cifre immesse.

## - Esercizio -

### 7.6 Selezionare numeri di chiamata memorizzati nella rubrica telefonica

Il richiamo di numeri di chiamata memorizzati nella rubrica telefonica (vedi "Immettere numero di chiamata nella rubrica telefonica" capitolo 8.1) è rapido e semplice.

1. Premere il tasto . Il display indica in ordine alfabetico la prima voce memorizzata nell'elenco telefonico. Con i tasti e si ha modo di selezionare una delle voci dall'elenco telefonico. Per selezionare la voce direttamente, premere il tasto che corrisponde alla lettera iniziale della voce desiderata. Per es. per il nome "Peter" premere una volta il tasto "7".
2. Premendo il tasto per selezionare il numero di chiamata visualizzato.

### 7.7 Visualizzazione della durata di chiamata

Dieci secondi dall'inizio della conversazione telefonica, sul display è visualizzata la durata di chiamata al posto del numero selezionato.

### 7.8 Attivare/Disattivare l'unità portatile

Per disattivare o attivare l'unità portatile, premere il tasto per tre secondi.

**Avvertenza:** Avendo disattivato l'unità portatile, non sarà più possibile ricevere chiamate.

### 7.9 Impostare il volume del ricevitore

Premere durante lo svolgimento della chiamata i tasti o per impostare il volume del ricevitore in base alle proprie esigenze. E' possibile scegliere tra 5 livelli di volume differenti.

### 7.10 Ripetizione di chiamata

I 10 numeri di chiamata selezionati per ultimo possono essere nuovamente composti.

1. Premere il tasto . Sul display appare a questo punto il numero di chiamata composto per ultimo.
2. Con il tasto o si ha modo di selezionare un numero di chiamata dall'elenco di ripetizione di chiamata.
3. Premendo il tasto per selezionare il numero di chiamata visualizzato.

**Avvertenza:** Se un numero di chiamata presente nell'elenco di ripetizione di chiamata è memorizzato nella rubrica telefonica, sul display appare il rispettivo nome.

#### 7.10.1 Cancellare un numero di chiamata dall'elenco di ripetizione di chiamata

1. Premere il tasto e selezionare con il tasto o la voce da cancellare.
2. Premere il tasto e confermare con il tasto .

**Avvertenza:** L'elenco di ripetizione di chiamata è cancellato completamente premendo il tasto per due secondi e confermando infine con il tasto .

### 7.11 Silenziamento del microfono nell'unità portatile

Premendo il tasto durante una chiamata telefonica in corso, il microfono dell'unità portatile è disattivato. Sul display viene visualizzato "Muting". Questo consente di parlare con una terza persona senza che il partner di chiamata possa sentire la conversazione. L'altoparlante presente nell'unità portatile rimane invece attivo, continuando a sentire il partner di chiamata in linea.

Premendo il tasto ancora una volta, l'impostazione di muting è nuovamente disattivata.

### 7.12 Attivare/Disattivare il blocco tastiera

Se l'unità portatile è condotta con sé, è possibile bloccarne la tastiera in modo da evitare di premere inavvertitamente dei tasti. L'attivazione del blocco tastiera consente ad ogni modo di ricevere telefonate in arrivo come di consueto.

1. Per attivare il blocco tastiera premere il tasto per tre secondi. Per disattivare, premere il tasto due volte.

### 7.13 Selezione a toni temporanea

Adoperando il telefono con la procedura di selezione a impulsi, non sarà necessario rinunciare ai vantaggi della procedura di selezione a TONI (per es. interrogazione a distanza di una segreteria telefonica). Per cambiare la modalità di selezione durante una telefonata, premere (4 secondi) il tasto ; fatto questo viene impostata temporaneamente la selezione a toni. Alla fine della chiamata il telefono torna alla procedura di selezione a impulsi.

### 7.14 Avvertenza riguardo la distanza

La portata dell'unità portatile è di ca. 50 metri in ambienti chiusi e di ca. 300 metri all'aperto. In presenza di un buon collegamento con la stazione base, sul display appare il simbolo .

**Avvertenza:** Nel caso di un allontanamento eccessivo dalla stazione base, il simbolo lampeggia facendo inoltre risuonare un segnale acustico di allarme. Avvicinarsi di nuovo alla stazione base altrimenti la chiamata in corso sarà interrotta. Nel caso in cui l'unità portatile dovesse aver perso il collegamento con la stazione base, sul display appare il messaggio "BASE 1".

### 7.15 Ricerca di unità portatile (tasto di paging)



Avendo perso d'occhio la propria unità portatile o non sapendo più dove è stata riposta, è possibile cercarla con l'aiuto della rispettiva stazione base.

1. Premere il tasto di paging presente presso la stazione base. Tutte le unità portatili registrate presso la base cominciano ad emettere segnali acustici.
2. Per concludere la ricerca, premere sulla stazione base nuovamente il tasto di paging o un qualsiasi tasto dell'unità portatile.

## **8 La rubrica telefonica**



La rubrica telefonica consente inoltre di memorizzare i 50 numeri di chiamata assieme al nome del rispettivo interlocutore. Per l'immissione di un nome sono disponibili 12 spazi per caratteri. La lunghezza max. di un numero di chiamata è di 20 spazi.

### **8.1 Immettere numero di chiamata nella rubrica telefonica**

1. Premere tre volte il tasto .
2. Immettere il nome ed il numero di chiamata desiderati. Confermare la rispettiva immissione premendo il tasto .

**Avvertenza:** Per l'immissione di testo vedi 8.1.2.

**Avvertenza:** Nel caso in cui il nome è già memorizzato all'interno della rubrica telefonica, si avverte un segnale e sul display appare l'indicazione "Aggiungere". Ciò significa che è necessario indicare un nome differente.

3. Selezionare con il tasto  o  la melodia desiderata e confermare con .  
La melodia desiderata risuona ogni volta che il partner di chiamata memorizzato chiama il telefono. Questa assegnazione funziona comunque solo nel caso in cui il proprio allacciamento telefonico e quello del chiamante sono abilitati alla visualizzazione del numero di chiamata ovvero alla funzione CLIP.

#### **8.1.1 Avvertenze riguardo la rubrica telefonica**



- I numeri di chiamata dovranno essere immessi sempre con il rispettivo prefisso, cosa che consente di assegnare anche ai numeri di chiamate urbane una delle voci dell'elenco telefonico.
- Una volta raggiunta la capacità di memorizzazione di 50 numeri di chiamata, sul display appare il messaggio "MEM PIENA" non appena si volesse procedere con un'ulteriore immissione. Per ottenere nuovo spazio di memoria sarà pertanto necessario cancellare prima un numero di chiamata già presente.

#### **8.1.2 Immissione di testo**





L'immissione di un nome viene eseguita utilizzando le lettere indicate sui tasti numerici del telefono. Premendo ripetutamente il tasto relativo, si ha modo di selezionare anche lettere maiuscole e cifre.

**Esempio:** Per immettere per es. il nome "Peter", procedere come segue.



Premere: 1 x tasto "7", 2 x tasto "3", 1 x tasto "8", 2 x tasto "3", 3 x tasto "7"

- Per immettere uno spazio vuoto premere una volta il tasto "1", per un trattino premere due volte il tasto "1".
- Al fine di inserire la stessa lettera una seconda volta, immettere la lettera e attendere fino a quando il cursore non si sarà spostato automaticamente sulla posizione successiva.
- Eventuali errori durante l'immissione sono cancellati con il tasto .
- Per spostare il cursore, premere il tasto  o .





### **8.2 Modificare voci memorizzate nella rubrica telefonica**

1. Premere due volte il tasto .
2. Premere il tasto  per selezionare l'opzione "MODIFICARE".
3. Confermare con il tasto  e selezionare quindi con il tasto  o  la voce desiderata.

**Avvertenza:** Per selezionare la voce direttamente, premere il tasto che corrisponde alla lettera iniziale della voce desiderata. Per selezionare per es. direttamente il nome "Peter", premere una volta il tasto "7".

4. Confermare con il tasto  e modificare quindi il nome visualizzato, il numero di chiamata e/o la melodia. Confermare ogni modifica premendo il tasto .

### **8.3 Cancellare voci memorizzate dalla rubrica telefonica**

1. Premere due volte il tasto .
2. Premere il tasto  per selezionare l'opzione "CANCELLARE".
3. Confermare con il tasto  e selezionare quindi con il tasto  o  la voce desiderata.

**Avvertenza:** Premendo invece il tasto  è possibile interrompere il processo di cancellazione.

4. Confermare la cancellazione premendo due volte il tasto .

## 9 Visualizzazione del numero di chiamata (CLIP)

Essendo abilitati alla visualizzazione del numero di chiamata, il display indica in caso di telefonata in arrivo il numero del rispettivo chiamante. Se il numero di chiamata è stato precedentemente memorizzato nella rubrica telefonica viene visualizzato il nome.

Nel caso di blocco da parte del chiamante della trasmissione del proprio numero telefonico, il numero di chiamata non sarà visualizzato. Sul display appare il messaggio "PRIVATO".

Sono 40 i numeri di chiamata memorizzati nell'elenco chiamate, funzione che consente di non perdere nessuna chiamata anche in caso di assenza. Se la lista è piena, il telefono cancella sempre il numero di chiamata più vecchio. In caso di memorizzazione di nuovi numeri di chiamata avvenute durante un'assenza, sul display appare il simbolo .







**Attenzione:** La visualizzazione del numero di chiamata (CLIP) oltre che della data e dell'orario sono delle informazioni aggiuntive trasmesse dal proprio gestore di rete telefonica. Si consiglia di rivolgersi al proprio gestore della rete telefonica per ricevere ulteriori informazioni a riguardo.



### 9.1 L'elencochiamate

#### 9.1.1 Selezionare il numero di chiamata dall'elenco chiamate

Per visualizzare il numero di chiamata tratto dall'elenco chiamate sul display, procedere come indicato qui di seguito:

1. Premere il tasto . Sul display viene visualizzato il numero dell'ultimo chiamante. Se l'elenco chiamate è invece vuoto, il display indica il messaggio "VUOTO".
2. Con il tasto  o  è possibile selezionare altri numeri di chiamata dall'elenco chiamate. Un segnale acustico risuona nel caso in mancanza di ulteriori numeri di chiamata. Due simboli visualizzati sul display indicano se la voce nell'elenco chiamate è stato già visto in precedenza o se la voce presente nell'elenco chiamate è una telefonata nuova.

Display	Descrizione
	Il numero di chiamata è stato già visto.
	Il numero di chiamata non è stato ancora visto.





3. Per comporre direttamente il numero di chiamata di un chiamante presente nell'elenco chiamate, premere il tasto .
4. Premendo il tasto  si esce dall'elenco chiamate.

**Avvertenza:** Premendo il tasto  è possibile ricevere ulteriori informazioni relative al numero di chiamata visualizzato.

- Se il numero di chiamata dovesse avere più di 12 cifre, sono visualizzate innanzitutto le rimanenti cifre che compongono il numero.
- E' visualizzato il numero di chiamata nel caso in cui il nome del chiamante sia già stato precedentemente memorizzato nella rubrica telefonica.
- Sono visualizzate data e ora qualora il chiamante abbia trasmesso queste informazioni.





#### 9.1.2 Memorizzare un numero di chiamata dall'elenco chiamate nella rubrica telefonica

L'apparecchio consente di memorizzare un numero di chiamata visualizzato nell'elenco chiamate direttamente nella rubrica telefonica.

1. Premere il tasto  e selezionare con  o  il numero di chiamata desiderato. Confermare la selezione premendo due volte il tasto .
2. Immettere il nome desiderato. Confermare l'immissione premendo il tasto .

**Avvertenza:** Per l'immissione di nomi vedi capitolo 8.1.2.



**Avvertenza:** Nel caso in cui il nome è già memorizzato all'interno della rubrica telefonica, si avverte un segnale e sul display appare nuovamente il numero di chiamata selezionato.

3. Il numero di chiamata è infine visualizzato ancora una volta sul display. Confermare premendo il tasto .
4. Selezionare con il tasto  o  la melodia desiderata e confermare con il tasto .



#### 9.1.3 Cancellare singoli numeri di chiamata dall'elenco chiamate

1. Premere il tasto  e selezionare con  o  il numero di chiamata desiderato.

**Avvertenza:** Premendo invece il tasto  è possibile interrompere il processo di cancellazione.



2. Premere il tasto . Confermare la cancellazione premendo il tasto .

#### 9.1.4 Cancellare tutti i numeri di chiamata dall'elenco chiamate







1. Premere il tasto .
2. Premere il tasto  per 3 secondi. Confermare la cancellazione premendo il tasto .

## 10 Funzioni speciali









E' dato modo di eseguire delle impostazioni presso unità portatile e stazione base in base alle proprie esigenze. Facendo questo è importante osservare:

- Se si è all'interno del menu, sul display appare il simbolo ⇄.
- Premendo il tasto  all'interno del menu si torna indietro di un livello. Premendo a lungo il tasto , il processo è interrotto nel livello in cui ci si trova attualmente. L'unità portatile torna nello stato di riposo.
- Ogni singolo processo si interrompe automaticamente se entro 20 secondi non si procede con una immissione.









### 10.1 Impostare il volume della base

1. Premere il tasto  sull'unità portatile e selezionare con il tasto  la voce di menu "IMPOSTARE".
2. Confermare con il tasto . Il display indica "VOLUME BASE".
3. Confermare con il tasto  e selezionare quindi con il tasto  o  il volume desiderato.
4. Confermare con il tasto .









### 10.2 Impostare la melodia di base

1. Premere il tasto  sull'unità portatile e selezionare con il tasto  la voce di menu "IMPOSTARE".
2. Confermare con il tasto  e selezionare quindi con il tasto  la voce di menu "MELODIA BASE".
3. Confermare con il tasto  e selezionare quindi con il tasto  o  la melodia desiderata.
4. Confermare con il tasto .

### 10.3 Modificare il PIN









1. Premere il tasto  sull'unità portatile e selezionare con il tasto  la voce di menu "IMPOSTARE".
2. Confermare con il tasto  e selezionare quindi con il tasto  la voce di menu "CODICE PIN".
3. Confermare con il tasto , immettere le quattro cifre del codice PIN (impostazione di default "0000") e confermare con .
4. Immettere un nuovo PIN a quattro cifre e confermare con .
5. Immettere il nuovo PIN una seconda volta e confermare con .

### 10.4 Procedura di selezione a TONI (PST) o a IMPULSI (PSI)

1. Premere il tasto  sull'unità portatile e selezionare con il tasto  la voce di menu "IMPOSTARE".
2. Confermare con il tasto  e selezionare quindi con il tasto  la voce di menu "MF-DC".
3. Confermare con il tasto  e selezionare quindi con il tasto  o  la procedura di selezione desiderata.
4. Confermare con il tasto .

### 10.5 Impostare il tempo flash

E' possibile impostare due tempi flash differenti. Flash 1 corrisponde a 100 ms e Flash 2 corrisponde a 300 ms.

1. Premere il tasto  sull'unità portatile e selezionare con il tasto  la voce di menu "IMPOSTARE".
2. Confermare con il tasto  e selezionare quindi con il tasto  la voce di menu "TASTO R".
3. Confermare con il tasto  e selezionare quindi con il tasto  o  il tempo flash desiderato.
4. Confermare con il tasto .



## - Funzioni speciali -







### 10.6 Ripristinare le impostazioni di default

Con questa funzione si ha modo di ripristinare le impostazioni di default per l'unità portatile e la stazione base.

#### Impostazione di default:

Lingua: Tedesco	Nome unità portatile: DSPG
Suono di avviso batteria: ON	Accettazione di chiamata automatica: ON
Suono di avviso portata: ON	Melodia di suoneria esterna: 3
Clic tasto: ON	Melodia di suoneria interna: 1
Volume del ricevitore: 3	Volume della segnalazione di chiamata unità portatile: 3
PIN: 0000	Melodia della segnalazione di chiamata base: 2
PAUSA: 3 secondi	Volume della segnalazione di chiamata base: 3
Procedura di selezione: PST/Toni	Tempo flash: 100 ms

**Avvertenza:** La rubrica telefonica, l'elenco chiamate (CLIP) e tutti i numeri di chiamata della ripetizione di chiamata sono cancellati.

1. Premere il tasto  sull'unità portatile e selezionare con il tasto  la voce di menu "IMPOSTARE".
2. Confermare con il tasto  e selezionare quindi con il tasto  la voce di menu "CONFIG INIZ".
3. Confermare con il tasto  e immettere con l'ausilio della tastiera le quattro cifre del PIN (impostazione di default "0000").
4. Confermare premendo due volte il tasto .

Fatto questo il telefono ripristina le impostazioni di default.

### 10.7 Attivare/Disattivare il suono tasti e le segnalazioni acustiche

E' possibile attivare o disattivare toni differenti.

- **Suono tasti**











Ogni volta che si preme un tasto sull'unità portatile si avverte un suono.

- **Suono di avviso "Batteria scarica"**

In presenza di batterie con capacità di carica limitata, un suono di avviso ricorda la necessità di dover provvedere a caricare l'unità portatile.

- **Segnale di avviso portata**









Essendosi allontanati troppo dalla stazione base si avverte un suono di avviso.

1. Premere il tasto  sull'unità portatile e selezionare con il tasto  la voce di menu "PORTATILE".
2. Confermare con il tasto . Il display indica "BIP".
3. Confermare con il tasto  e selezionare con il tasto  o  dalle opzioni "FUORI CAMPA", "BIP TASTI" e "BAT SCARICA".
4. Confermare con il tasto  e selezionare quindi con il tasto  o  l'opzione "ATTIVATO" ovvero "DISATTIVATO".
5. Confermare con il tasto .

### 10.8 Impostare il volume della suoneria di chiamata dell'unità portatile









E' possibile impostare il volume della suoneria chiamata scegliendo tra livelli differenti oppure disattivare il volume completamente. Avendo disattivato la suoneria chiamata, le chiamate in arrivo sono segnalate presso la stazione base oltre che sul display dell'unità portatile.

E' possibile assegnare un grado di volume differente per chiamate interne ed esterne.

1. Premere il tasto  sull'unità portatile e selezionare con il tasto  la voce di menu "PORTATILE".
2. Confermare con il tasto  e selezionare con il tasto  la voce di menu "VOL SUON INT" o "VOL SUON EST".
3. Confermare con il tasto  e selezionare quindi con il tasto  o  il volume desiderato.
4. Confermare con il tasto .







### 10.9 Impostare la melodia di suoneria dell'unità portatile

E' possibile assegnare melodie di suoneria differenti per chiamate interne ed esterne.

1. Premere il tasto  sull'unità portatile e selezionare con il tasto  la voce di menu "PORTATILE".
2. Confermare con il tasto  e selezionare con il tasto  la voce di menu "SUONERIA INT" o "SUONERIA EST".
3. Confermare con il tasto  e selezionare quindi con il tasto  o  la melodia desiderata.
4. Confermare con il tasto .

## - Funzioni speciali -







### 10.10 Impostare l'orario

1. Premere il tasto  sull'unità portatile e selezionare con il tasto  la voce di menu "PORTATILE".
2. Confermare con il tasto  e selezionare quindi con il tasto  la voce di menu "IMPOSTA ORA".
3. Confermare con il tasto  e immettere per mezzo della tastiera l'orario attuale sulla base del formato orario di 24 ore.  
Esempio: Ore 17:53 => 1753 oppure ore 6:47 => 0647
4. Confermare con il tasto .



### 10.11 Sveglia ON/OFF

**Avvertenza:** Il segnale di sveglia si avverte solo presso l'unità portatile, non quindi sulla base.

Il segnale di sveglia si avverte in caso di disattivazione del volume della suoneria chiamata presso l'unità portatile.









1. Premere il tasto  sull'unità portatile e selezionare con il tasto  la voce di menu "PORTATILE".
2. Confermare con il tasto  e selezionare quindi con il tasto  la voce di menu "ALLARME ON".
3. Confermare con il tasto  e selezionare quindi con il tasto  o  l'opzione "ATTIVATO".

**Avvertenza:** Volendo disattivare la sveglia, selezionare al punto 4 l'opzione "DISATTIVATO" e confermare quindi con il tasto .

4. Confermare con il tasto  e immettere l'orario di sveglia desiderato sulla base del formato orario di 24 ore.
5. Confermare con il tasto . La sveglia è ora attivata.





### 10.12 Accettare le chiamate automaticamente

Estraendo l'unità portatile dalla stazione base le chiamate in arrivo sono accettate automaticamente. Se si desidera accettare invece le chiamate premendo il tasto  sarà necessario disattivare la funzione di accettazione automatica predefinita.

1. Premere il tasto  sull'unità portatile e selezionare con il tasto  la voce di menu "PORTATILE".
2. Confermare con il tasto  e selezionare quindi con il tasto  la voce di menu "RISP AUTO".
3. Confermare con il tasto  e selezionare quindi con il tasto  o  l'opzione "ATTIVATO" ovvero "DISATTIVATO".
4. Confermare con il tasto .

### 10.13 Modificare il nome dell'unità portatile

A conclusione di una chiamata, sul display sono visualizzati alternativamente la durata di conversazione ed il nome dell'unità portatile. Se è stato selezionato un maggior numero di unità portatili alla stazione base, si consiglia di assegnare un nome ad ognuna delle unità portatili.









1. Premere il tasto  sull'unità portatile e selezionare con il tasto  la voce di menu "PORTATILE".
2. Confermare con il tasto  e selezionare quindi con il tasto  la voce di menu "NOME".
3. Confermare con il tasto  e immettere con il nome desiderato (massimo 10 caratteri).

**Avvertenza:** Per l'immissione di testo vedi capitolo 8.1.2.

4. Confermare con il tasto .

### 10.14 Impostare la lingua

E' possibile scegliere lingue differenti per i testi visualizzati nei menu.

1. Premere il tasto  sull'unità portatile e selezionare con il tasto  la voce di menu "PORTATILE".
2. Confermare con il tasto  e selezionare quindi con il tasto  la voce di menu "LINGUA".
3. Confermare con il tasto  e selezionare quindi con il tasto  o  la lingua desiderata.
4. Confermare con il tasto .

## **11 Maggior numero di unità portatili**

E' possibile registrare cinque unità portatili alla stazione base. Ogni unità portatile può essere selezionata contemporaneamente presso una sola stazione base.

**Avvertenza:** Lo standard internazionale GAP consente di integrare unità portatili SWITEL così come unità portatili di altri costruttori in un unico sistema telefonico. Allo stesso modo è possibile selezionare unità portatili SWITEL per stazioni base di altri costruttori, a condizione che gli apparecchi dispongano della funzione GAP standard.

L'uso di un maggior numero di unità portatili offre le seguenti possibilità:

- Chiamate interne tra le unità portatili.
- Chiamate esterne possono essere trasferite da un'unità portatile all'altra.
- Segnalazione di chiamate esterne in arrivo presso tutte le unità portatili in uso.
- Conversazione a conferenza con un interlocutore esterno e due interni.

**Avvertenza:** Nel caso in cui un'altra unità portatile adoperasse già la linea telefonica esterna, sul display appare il simbolo **EXT**. La conduzione di un'ulteriore chiamata non è pertanto possibile.

### **11.1 Telefonate interne**

Avendo selezionato un numero maggiore di unità portatili presso la stazione base sarà possibile condurre chiamate interne senza alcun addebito.

1. Premere il tasto **[INT]** ed il numero di chiamata dell'unità portatile, per es. "2".
2. La telefonata sarà ricevuta presso l'unità portatile chiamata.

**Avvertenza:** In caso di arrivo di una telefonata esterna durante la conduzione di una chiamata interna, si avvertono dei brevi segnali acustici ed il numero del chiamante, qualora disponibile, è visualizzato sul display.

3. Concludere la chiamata interna premendo il tasto **[📞]**.
4. Premere nuovamente il tasto **[📞]** per ricevere la chiamata esterna.

### **11.2 Trasferimento di chiamate esterne ad un'altra unità portatile**

Avendo accettato una chiamata esterna con una delle unità portatili, è possibile trasferire la chiamata esterna su un'altra unità portatile.

Premere a tale scopo il tasto **[INT]** e quindi il numero interno, per es. "2", dell'unità portatile desiderata.

**Avvertenza:** Se l'unità portatile selezionata non dovesse rispondere, la chiamata potrà essere ripresa con il tasto **[INT]**.

Dopo che la chiamata interna è stata accettata dall'altra unità portatile, è possibile scegliere tra le seguenti possibilità:

1. **Riscontro / Chiamata in attesa:** E' dato modo di parlare con l'interlocutore interno e di passare nuovamente al partner di chiamata esterno premendo il tasto **[INT]**. Il numero di passaggi della chiamata tra interlocutore esterno ed interno è illimitato.
2. **Trasferire una chiamata:** Premendo il tasto **[📞]** sulla prima unità portatile, la telefonata esterna è trasferita sull'unità portatile chiamata.

### **11.3 Condurre chiamate a conferenza**

Questa funzione consente di condurre una conferenza con una chiamata esterna ed un altro interlocutore interno. In altre parole, due unità portatili possono in tal modo conversare contemporaneamente con un interlocutore esterno.

1. Compiere il collegamento con l'interlocutore esterno desiderato.
2. Premere il tasto **[INT]** ed il numero di chiamata interno della seconda unità portatile desiderata.
3. Non appena il secondo interlocutore interno ha accettato la telefonata, premere il tasto **[👥]** e tutti e tre gli interlocutori sono ora in grado di conversare in conferenza.

**Avvertenza:** Durante la conferenza è possibile trattenere il partner di chiamata esterno premendo il tasto **[INT]**. Premendo la sequenza di tasti **[INT] [👥]** si fa ritorno alla conversazione a conferenza.

4. La conferenza è terminata non appena uno degli interlocutori interni aggancia la telefonata.

## - **Maggior numero di unità portatili** -

### **11.4 Selezione e deselegione di unità portatili**

#### **11.4.1 Selezione di unità portatili**

1. Premere il tasto di ricerca unità portatile (tasto di paging) **Ⓜ**) sulla stazione base per 3 secondi fino ad avvertire due segnali acustici. Procedere quindi alla selezione della nuova unità portatile entro 90 secondi.
2. Premere il tasto **☰** sull'unità portatile e selezionare con il tasto **▼** la voce di menu "REGISTRARE".
3. Confermare con il tasto **☰** e selezionare quindi con il tasto **▲** o **▼** la voce di menu "REGIST BASE".
4. Confermare con il tasto **☰** e immettere con l'ausilio della tastiera il numero della stazione base (1 fino a 4). Nel caso in cui l'unità portatile dovesse essere già collegata con una stazione base, i numeri già assegnati lampeggiano.
5. Confermare con il tasto **☰**. E' avviata la ricerca della stazione base.
6. Dopo aver individuato la stazione base sarà necessario immettere il PIN (impostazione di default 0 0 0 0).
7. Confermare con il tasto **☰**. Dopo alcuni secondi si avverte un segnale acustico.  
L'unità portatile è stata registrata ed è utilizzabile per condurre chiamate esterne ed interne.

**Avvertenza:** All'unità portatile è assegnato un numero di chiamata interno. All'unità portatile già selezionata sarà assegnato il numero di chiamata 1. Alla seconda unità portatile selezionata sarà invece assegnato il numero di chiamata 2. Questo numero di chiamata interno è visualizzato a destra sul display.

#### **11.4.2 Selezione di altri telefoni DECT-GAP sulla stazione base**

Per selezionare l'unità portatile DECT-GAP di un altro costruttore, seguire le indicazioni riportate nel manuale di istruzioni per l'uso del rispettivo costruttore e premere quindi il tasto di ricerca unità portatile (tasto di paging) **Ⓜ**) sulla stazione base per 3 secondi. Immettere per la selezione il PIN (impostazione di default: 0000).

#### **11.4.3 Deselezione di unità portatili**

La deselegione di un'unità portatile può essere compiuta solo da parte di un'altra unità portatile ancora selezionata. Non è possibile compiere questa deselegione con la stessa unità portatile che si desidera deselegionare.

1. Premere il tasto **☰** sull'unità portatile e selezionare con il tasto **▼** la voce di menu "IMPOSTARE".
2. Confermare con il tasto **☰** e selezionare quindi con il tasto **▲** o **▼** la voce di menu "CANC PORT".
3. Confermare con il tasto **☰** e immettere con l'ausilio della tastiera il PIN (impostazione di default: 0000).

**Avvertenza:** Con il tasto **☰** si interrompe il processo in corso.

4. Confermare con il tasto **☰** e immettere il numero interno dell'unità portatile che si desidera deselegionare.
5. Un segnale acustico che si avverte dopo qualche secondo conferma che la deselegione è stata eseguita con successo. L'unità portatile è stata deselegionata e non è più utilizzabile per condurre chiamate esterne ed interne.

### **11.5 Stazioni base addizionali**

In caso di impiego di un maggior numero di stazioni base è possibile estendere la portata dell'unità portatile. Per poter godere di questo effetto è necessario che tutte le stazioni base siano collegate ad un unico allacciamento telefonico. A seconda dell'impiego desiderato, è possibile assegnare ad ognuna delle stazioni base lo stesso numero telefonico oppure un numero di chiamata differente. Fare in modo che vi sia sufficiente intersezione nella portata di tutte le stazioni base in uso. L'unità portatile dovrà inoltre essere registrata presso ognuna delle stazioni base. Si consiglia di provare prima della messa in funzione di una stazione base nuova, la portata della propria unità portatile.

Avendo registrato un'unità portatile presso le stazioni base e attivato la selezione automatica della stazione base (vedi 11.5.1), l'unità portatile è in seguito trasferita automaticamente alla stazione base più vicina.

#### **11.5.1 Selezione di una stazione base**

1. Premere il tasto **☰** sull'unità portatile e selezionare con il tasto **▼** la voce di menu "REGISTRARE".
2. Confermare con il tasto **☰** e selezionare quindi con il tasto **▲** o **▼** la voce di menu "REGIST BASE".
3. Confermare con il tasto **☰**. Sul display sono visualizzate tutte le stazioni base presso le quali l'unità portatile risulta già registrata. Il numero della stazione base attiva lampeggia. Selezionare con la tastiera la stazione base desiderata presso la quale registrare l'unità portatile.  
Oppure passare con il tasto **▼** all'opzione "AUTO". Questa impostazione consente all'unità portatile di passare automaticamente alla stazione base più vicina nel caso in cui il collegamento con la stazione base attuale è interrotto.

## - Eliminazione di errori -

### 12 Eliminazione di errori

In presenza di problemi con il telefono, si prega di verificare innanzitutto quanto riportato nelle seguenti indicazioni. In caso di reclami entro il periodo di garanzia, rivolgersi al rivenditore autorizzato.

Errore	Soluzione
Non è possibile condurre una chiamata telefonica	<ul style="list-style-type: none"><li>- La linea telefonica non è collegata correttamente oppure presenta un guasto. Utilizzare esclusivamente il cavo per telefono fornito.</li><li>- Provare con un altro telefono se l'allacciamento telefonico in questione è funzionante.</li><li>- L'alimentatore a spina non è inserito oppure si è in presenza di una caduta di tensione totale.</li><li>- Le batterie standard ricaricabili sono scariche o difettose.</li><li>- La distanza dalla stazione base è troppo grande.</li></ul>
Collegamento disturbato, si interrompe	<ul style="list-style-type: none"><li>- La distanza dalla stazione base è troppo grande.</li><li>- Luogo di installazione della stazione base errato.</li></ul>
Non è possibile compiere una selezione	<ul style="list-style-type: none"><li>- Procedura di selezione non è impostata correttamente (vedi capitolo 10.4).</li></ul>
Il sistema non reagisce più oppure è in uno stato indefinito	<ul style="list-style-type: none"><li>- Ripristinare nuovamente le impostazioni di default (vedi capitolo 10.6). Estrarre prima brevemente l'alimentatore di rete dalla presa di corrente.</li></ul>
La spia di controllo dello stato di carica non è accesa	<ul style="list-style-type: none"><li>- Posizionare l'unità portatile correttamente nella stazione base, pulire le superfici di contatto presso unità portatile e stazione base con un panno morbido e asciutto.</li></ul>
Dopo un paio di ore sul display lampeggia il simbolo delle batterie	<ul style="list-style-type: none"><li>- Posizionare l'unità portatile per la durata di 14 ore nella stazione base. Se ciò non dovesse essere sufficiente, sostituire le batterie standard ricaricabili.</li></ul>
Visualizzazione sul display è scura	<ul style="list-style-type: none"><li>- Il difetto è causato da raggi del sole diretti, fare raffreddare l'unità portatile.</li></ul>

## - Informazioni importanti -

### 13 Informazioni importanti

#### 13.1 Dati tecnici

Caratteristica	Valore
Standard	DECT-GAP
Alimentazione elettrica	Stazione base 220/230 V, 50 Hz
Distanza (esterni/interni)	300 m / 50 m
Autonomia di stand-by	fino a 110 ore
Autonomia di chiamata	fino a 10 ore
Batterie standard ricaricabili	2 x AAA (1.2V / 550 mAh)
Procedura di selezione	PST oppure PSI
Temperatura ambiente consentita	10°C fino 30°C
Umidità atmosferica relativa consentita	da 20% a 75%
Tempi flash	100 ms o 300 ms

DECT: **D**igital **E**uropean **C**ordless **T**elephone = Standard per telefoni senza cavo.

GAP: **G**eneric **A**ccess **P**rofile = Standard per l'interazione di unità portatili con stazioni base di altri costruttori.

#### 13.2 Garanzia

Gli apparecchi Switel sono costruiti e collaudati in osservanza dei processi di produzione più moderni. L'impiego di materiali selezionati e tecnologie altamente sviluppate garantiscono un perfetto funzionamento ed una lunga durata in vita. Non è possibile richiamarsi alla presente garanzia nel caso in cui la causa per il malfunzionamento dell'apparecchio risalga al gestore della rete telefonica o ad un eventuale impianto telefonico interno interposto. La garanzia non si estende alle batterie standard o compatte ricaricabili utilizzate all'interno degli apparecchi. Il periodo di garanzia ricopre 24 mesi a partire dalla data di acquisto.

Entro il periodo di garanzia sarà eliminato gratuitamente qualsiasi guasto relativo a difetti di materiale o di produzione. La garanzia rilasciata cessa in caso di intervento da parte dell'acquirente o di terze persone. La presente garanzia non ricopre danni dovuti all'uso o all'esercizio non conforme a quanto previsto, ad un errato montaggio o conservazione, a collegamento o installazione impropri così come a forza maggiore o a qualsiasi altro influsso esterno. In qualità di produttore ci riserviamo il diritto, in caso di reclami, di riparare o sostituire le parti difettose o di rimpiazzare l'apparecchio. Parti sostituite o apparecchi rimpiazzati divengono di nostra proprietà. Si escludono richieste di risarcimento danni, qualora non fondate su intenzione o colpa grave da parte del costruttore.

Nel caso in cui il presente apparecchio dovesse ciò nonostante presentare un difetto durante il periodo di garanzia, si prega di rivolgersi esclusivamente al negozio di rivendita dell'apparecchio SWITEL assieme al relativo scontrino di acquisto. In base alle presenti disposizioni, tutti i diritti di garanzia dovranno essere fatti valere esclusivamente nei confronti del rivenditore autorizzato. A decorrere da due anni dalla data di acquisto e consegna dei nostri prodotti non sarà più possibile fare valere eventuali diritti a garanzia.

## - Contents -

<b>1</b>	<b>General Information</b>	<b>65</b>
1.1	Intended use	65
1.2	Power failure	65
1.3	Installation location	65
1.4	Power supply	65
1.5	Rechargeable standard batteries	65
1.6	Charging the handset	65
1.7	Private branch exchanges	65
1.8	Information on disposal	65
1.9	Notes on medical equipment	65
1.10	Temperature and ambient conditions	66
1.11	Cleaning and upkeep	66
<b>2</b>	<b>Features</b>	<b>66</b>
2.1	Telephone	66
<b>3</b>	<b>Operating Elements</b>	<b>67</b>
3.1	Handset	67
3.2	Base station	67
<b>4</b>	<b>Private Branch Exchanges / Supplementary Services</b>	<b>68</b>
4.1	R button on private branch exchanges	68
4.2	R button and supplementary services provided by Swisscom	68
4.3	Dialling pause	68
<b>5</b>	<b>Starting Up</b>	<b>69</b>
5.1	Safety notes	69
5.2	Checking the package contents	69
5.3	Connecting the base station	69
5.4	Inserting the standard batteries	69
5.5	Charging the standard batteries	69
5.6	Tone or Pulse dialling mode	69
<b>6</b>	<b>Menu Structure</b>	<b>70</b>
<b>7</b>	<b>Operation</b>	<b>72</b>
7.1	Display	72
7.2	External answering machine	72
7.3	Taking a call	72
7.4	Taking two calls	72
7.5	Making a call	72
7.6	Dialling phone numbers stored in the phone book	73
7.7	Displaying the call timer	73
7.8	Switching the handset on /off	73
7.9	Adjusting the receiver volume	73
7.10	Redialling button	73
7.10.1	Deleting a number from the redialling list	73
7.11	Muting the microphone in the handset	73
7.12	Key lock on/off	73
7.13	Temporary tone dialling	73
7.14	Information on the range	73
7.15	Locating the handset (paging)	73
<b>8</b>	<b>Phone Book</b>	<b>74</b>
8.1	Entering phone numbers in the phone book	74
8.1.1	Information on the phone book	74
8.1.2	Text entry	74
8.2	Editing entries in the phone book	74
8.3	Deleting stored entries from the phone book	74

## - Contents -

<b>9</b>	<b>Caller Number Display (CLIP Function)</b> .....	<b>75</b>
9.1	Calls list .....	75
9.1.1	Selecting phone numbers from the calls list .....	75
9.1.2	Storing phone numbers from the calls list in the phone book .....	75
9.1.3	Deleting individual numbers from the calls list .....	75
9.1.4	Deleting all the numbers from the calls list .....	75
<b>10</b>	<b>Special Functions</b> .....	<b>76</b>
10.1	Setting the base station volume .....	76
10.2	Setting the base station melody .....	76
10.3	Change PIN .....	76
10.4	Tone or Pulse dialling mode .....	76
10.5	Setting Recall (Flash time) .....	76
10.6	Restoring the default settings .....	77
10.7	Switching the key tone and warning tones on/off .....	77
10.8	Setting the handset volume .....	77
10.9	Setting the handset ringing melody .....	77
10.10	Setting the time .....	78
10.11	Alarm on/off .....	78
10.12	Answering calls automatically .....	78
10.13	Changing the name of the handset .....	78
10.14	Setting the language .....	78
<b>11</b>	<b>Multiple Handsets</b> .....	<b>79</b>
11.1	Internal calls (intercom function) .....	79
11.2	Transferring external calls to another handset .....	79
11.3	Conference calls .....	79
11.4	Registering and deregistering handsets .....	80
11.4.1	Registering handsets .....	80
11.4.2	Registering other DECT-GAP telephones on the base station .....	80
11.4.3	Deregistering handsets .....	80
11.5	Additional base stations .....	80
11.5.1	Dialling a base station .....	80
<b>12</b>	<b>Troubleshooting</b> .....	<b>81</b>
<b>13</b>	<b>Important Information</b> .....	<b>82</b>
13.1	Technical data .....	82
13.2	Guarantee .....	82



## **1 General Information**

Please read this operating instruction manual thoroughly. Under no circumstances open the device or complete any repair work yourself. In the case of claims under the terms of guarantee, contact your sales outlet. We reserve the right to make technical and optical modifications to the product during the course of product improvement.

### **1.1 Intended use**

This telephone has been developed for use when connected to an analogue telephone network connection (PSTN) within Switzerland. However, due to the different services offered by the various telecommunication network providers, there is no guarantee that the equipment will function trouble-free on every telecommunication terminal connection. Only connect the telephone line from the telephone to a telephone line socket designed for it. Never change the plug on the connection cable.

### **1.2 Power failure**

The telephone cannot be used to make calls in the event of a power failure. Always keep a cord connected telephone which operates without an external power supply available in the case of emergencies.

### **1.3 Installation location**

The installation location is a decisive factor to ensure trouble-free operation. The equipment must be set up in the vicinity of a 230 Volt mains power outlet.

Do not place the base station in the direct vicinity of other electronic equipment, such as microwave ovens or hi-fi systems, since they could cause mutual disturbance. Therefore, maintain a distance of at least one meter from other electronic equipment. Place the base station on a level, non-slip surface. Normally, the footpads on the base station do not leave any marks on the surface where it is located. However, due the diverse types of paints and surfaces which come into question, it cannot be fully ruled out that the footpads will leave marks on the surface on which it is located.

### **1.4 Power supply**

Only use the SWITEL power adapter plug supplied because other power supplies could destroy the telephone. Do not open the power adapter plug. There is a risk of fatal injury if the power adapter plug is opened and not disconnected from the power supply.

### **1.5 Rechargeable standard batteries**

Use the rechargeable standard batteries supplied. When replacing batteries, only use those of the type AAA 1.2V 550mAh. Other standard batteries or power packs could cause a short circuit.

Do not throw rechargeable standard batteries into a fire or immerse them in water. The maximum standby and talk times specified apply to the rechargeable standard batteries supplied when used under optimum conditions.

Ambient temperature, charging cycles and other external factors, such as radio loading in the area of use, can affect operating times considerably. In addition, the charge capacity is reduced for technical reasons during use or when stored at extremely high or low temperatures.

### **1.6 Charging the handset**

The handset warms up during the charging process. This is normal and does not represent a risk. Do not charge the handset on an external charging unit as this could damage it.

### **1.7 Private branch exchanges**

The telephone can also be connected to a private branch exchange. Ask the dealer where your private branch exchange was purchased whether the telephone will function properly on the private branch exchange. There is **no** guarantee that the telephone will work on every private branch exchange.

### **1.8 Information on disposal**

The implementation of European law in national laws and directives obliges you to dispose of consumable goods appropriately. This serves to protect both persons and the environment.

The adjacent symbol indicates that electrical and electronic apparatus no longer required must be disposed of separate from domestic waste.

**Equipment which is old or has outlived its service life** must be disposed of at a suitable collection point provided by the public waste authorities.

**Batteries and power packs** must be disposed of at the point of sale or at the appropriate collection points provided by the public waste authorities.

**Packaging materials** must be disposed of according to local regulations.

### **1.9 Notes on medical equipment**

The telephone operates with a very low transmitting power. The current level of knowledge from research and technology indicates that such low transmitting power does not represent a risk to health. It has been shown, however, that portable telephones, when switched on, can affect medical equipment. Therefore, never use the telephone in the vicinity of medical equipment. There is no evidence to date that DECT telephones affect heart pacemakers but it cannot be fully ruled out. DECT telephones can cause an unpleasant humming sound in hearing aids.



## - General Information -

### 1.10 Temperature and ambient conditions

The telephone is designed for use in protected rooms with a temperature range from 10 °C to 30 °C. The base station should not be used in rooms exposed to moisture, such as bathrooms or laundries. Do not locate the device in the vicinity of sources of heat such as radiators, and never expose it to direct sunlight.

Do not use the handset in potentially explosive areas.

Prevent excessive exposure to smoke, dust, vibration, chemicals, moisture, heat and direct sunlight.

### 1.11 Cleaning and upkeep

Clean the housing surfaces with a soft, dry, fluff-free cloth. Never use cleaning agents or aggressive solvents. Apart from occasionally cleaning the housing, no other upkeep is necessary. The rubber footpads on the base station are not resistant to all cleaning agents. The manufacturer is not liable for any claims for damage to furniture or such.

## - Features -

## 2 Features

### 2.1 Telephone

- Digital DECT / GAP standard
- Up to 10 hours continuous conversation - up to 110 hours standby
- Voice scrambling for high level of security
- Tone/Pulse dialling modes
- Caller number display (CLIP function)
- Calls list for up to 40 phone numbers
- Redialling the last 10 call numbers
- Phone book for up to 50 phone numbers and associated names
- 24-hour clock with alarm function integrated in the handset
- Displaying the call timer
- Can be extended by registering more GAP-compatible DECT handsets
- Multilink operation with up to five handsets
- Free internal calls possible between two handsets
- Conference facility between two handsets and an external caller
- Transferring calls between handsets
- Ringing melodies on the handsets and base station can be adjusted in many ways
- VIP call (melody assignment)
- Suitable for supplementary services provided by your telephone network provider (Hook-Flash) - capable of use in a private branch exchange
- Muting function
- Key lock

DECT: **D**igital **E**uropean **C**ordless **T**elephone = Standard for cordless telephones.

GAP: **G**eneric **A**ccess **P**rofile = Standard for the interoperation of handsets and base stations from other manufacturers.

## - Operating Elements -

### 3 Operating Elements

#### 3.1 Handset

1. Call indicator
2. Redialling button
3. Menu
4. Phone book
5. Scrolling button / Calls list (CLIP)
6. Internal and conference calls
7. R-signal button / On/Off
8. Call button
9. Muting / Delete button

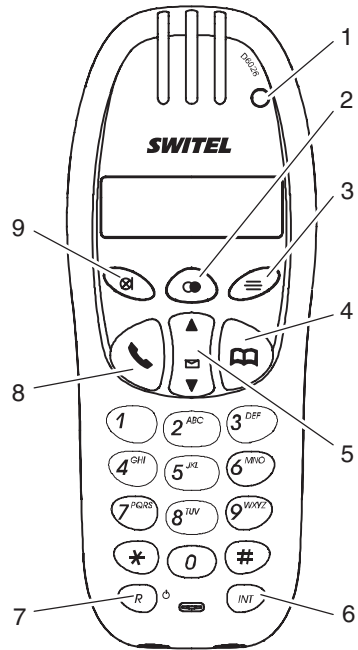

#### 3.2 Base station

10. Paging button (locate handset)
11. LED, call and power indicator
12. LED, charging control lamp

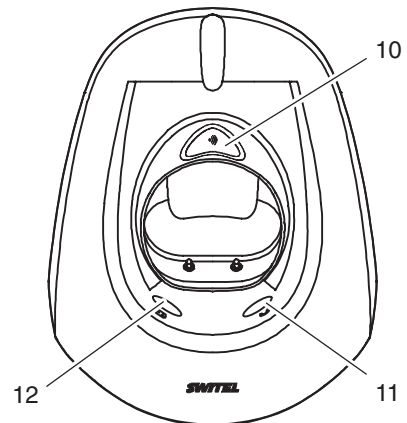

## **4 Private Branch Exchanges / Supplementary Services**

The **[R]** button on the handset is used in private branch exchanges and for taking advantage of supplementary services provided by telephone network provider.

### **4.1 **[R]** button on private branch exchanges**

If the telephone is connected to a private branch exchange, all the functions associated with the **[R]** button, such as transferring calls, automatic call back, etc., can be used. A private branch exchange requires a Flash time of 100 ms (refer to Chapter 10.5). The dealer where you purchased the exchange can provide information as to whether the telephone will work properly with the exchange.

### **4.2 **[R]** button and supplementary services offered by your telephone network provider**

Your SWITEL telephone supports the most important supplementary services provided by your telephone network provider (e.g. brokering, call waiting, three-way conferencing, etc.). To use the supplementary services offered by your telephone network provider, set the Flash time to 300 ms (for settings, refer to Chapter 10.5).

Please contact your telephone network provider with regard to enabling the supplementary services.

### **4.3 Dialling pause**

In the case of private branch exchanges, it is necessary to dial a specific number (e.g. "9" or "0") in order to obtain the dialling tone for an outside line. When using some older private branch exchanges, it takes a little time before the dialling tone becomes audible. Particularly in the case of such private branch exchanges, it is possible to insert an automatic pause after the number for the outside line so that the number can be dialled in a continuous process without having to wait for the dialling tone.

Press the **[C]** button once between dialling the number for the outside line and the actual phone number. "P" appears in the display. After dialling the number for the outside line, the telephone waits 3 seconds before dialling the actual phone number.

**Note:** The pause can also be entered with the phone numbers in the phone book.

## - Starting Up -

### 5 Starting Up

#### 5.1 Safety notes



**Caution:** It is essential to read the General Information at the beginning of this manual before starting up.

#### 5.2 Checking the package contents

The package contains:

a base station	a telephone connection cable
a handset	two standard batteries
a power adapter plug	an operating manual

#### 5.3 Connecting the base station

Position the base station within reach of the telephone line socket and a power outlet. Only use the components supplied.

1. Insert the small plug on the power adapter plug cable in the corresponding socket on the underside of the base station.

**Note:** The plug cannot be connected incorrectly because the plug and socket are designed in such a way to prevent reverse poling. The plugs must snap audibly into the base station sockets.

2. Insert the small plug on the telephone connection cable in the corresponding socket on the underside of the base station.
3. Feed both cables on the underside of the base station in the cable duct provided.
4. Plug the power adapter plug in a properly installed 230 Volt power outlet.  
The power adapter plug from the base station must remain connected at all times.
5. Connect the telephone connection cable supplied in the telephone line socket.

#### 5.4 Inserting the standard batteries

In order to insert the rechargeable standard batteries in the handset, press on the top edge of the battery compartment cover and slide it downwards. Only insert standard batteries. Pay attention to correct polarity. Close the battery compartment cover.

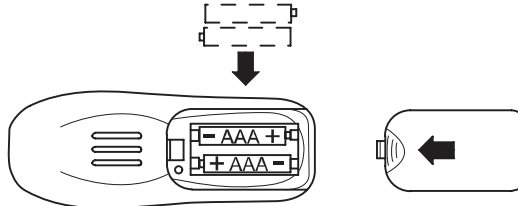

#### 5.5 Charging the standard batteries

Place the handset, with its display facing the front, in the base station for at least 14 hours. The charging control lamp on the base station lights up. Failure to charge the standard batteries properly can lead to telephone malfunction.

The rechargeable standard batteries in the handset have a maximum standby time of 110 hours at room temperature. The maximum talk time is 10 hours.

The current battery charge status is indicated in the display:

Full	Half empty	Low	Empty

#### 5.6 Tone or Pulse dialling mode

This feature enables the telephone to be connected and used on both analogue (pulse dialling) and digital (tone dialling) connections. The equipment is set to TONE dialling (DTMF) at the factory. If the telephone does not work on your telephone connection, refer to Chapter 10.4 to learn how to switch the telephone to pulse dialling.

**- Menu Structure -**

**6 Menu Structure**

This section describes the menu structure of your telephone. When the telephone is in standby, open the menu by pressing the  button.

Phone Book	Add Entry	Name ?	Number ?	Melody 1-5
	Modify Entry			
	Delete Entry			

Setup	Base Volume	Volume 1, 2, 3, 4, 5, Volume Off		
	Base Melody	Melody 1, 2, 3, 4, 5		
	Del Handset	PIN? (default 0000)		
	PIN Code	PIN? (default 0000)	New PIN	Retype
	Dial Mode	Tone Dial		
		Pulse Dial		
	Recall	Recall 1		
		Recall 2		
	Default	PIN? (default 0000)	Confirm ?	











**- Menu Structure -**

Handset	Beep	Key Tone	On - Off
		Empty	On - Off
		Range	On - Off
	Int Ring Vol	Volume 1, 2, 3, 4, 5, Volume Off	
	Ext Ring Vol	Volume 1, 2, 3, 4, 5, Volume Off	
	Int Melody	Melody 1, 2, 3, 4, 5	
	Ext Melody	Melody 1, 2, 3, 4, 5	
	Clock Set	Current Time	
	Alarm Set	On - Off	Time
	Auto Answer	On - Off	
	Name	.....	
	Language	Deutsch	
		English	
		Francais	
	Italiano		
Key Lock			



Register	Select Base	BS 1 _ _ _
		Auto
	Reg Base	BS 1 2 3 4

## 7 Operation

### 7.1 Display

Display	Description
	<b>On:</b> A call is currently being made.
EXT	<b>On:</b> An external call is currently being made. <b>Flashing:</b> An external call has been received.
	<b>On:</b> An internal call is currently being made. <b>Flashing:</b> An internal call has been received.
	<b>On:</b> You have accessed the calls list. <b>Flashing:</b> There are new calls in the calls list.
	<b>On:</b> The phone number, called from the calls list, has not been answered.
	<b>On:</b> The phone number, called from the calls list, has been answered.
	<b>Flashing:</b> Batteries must be charged. <b>On:</b> Displays battery capacity. <b>Runs through the segments:</b> Batteries are being charged.
	<b>On:</b> The phone book is open.
	<b>On:</b> Programming mode has been activated.
	<b>On:</b> Key lock has been activated.
	<b>On:</b> The connection to the base station is good. <b>Flashing:</b> The handset is out of range of the base station.
	<b>On:</b> The phone number is in excess of 12 digits.

### 7.2 External answering machine

The  icon indicates a new message has been recorded for you on the external answering machine. The  icon is only displayed when the equipment is connected to a digital telephone connection. The icon disappears after playing the message.



**Caution:** The external answering machine and transmission of the  icon is a supplementary service provided by your telephone network provider. Contact your network provider for further information.

### 7.3 Taking a call

When a call is received, both the handset and base station ring. Take the handset from the base station or press the Call button . A connection is established.

To end the call, replace the handset in the base station or press the  button.

**Note:** When the handset is ringing, press the  or  button to adjust the ringing volume.

### 7.4 Taking two calls



You will hear acoustic signals (call waiting) if a second call is received while you are carrying out a telephone conversation. The number of the second caller appears in the display. Press the  and "2" buttons in sequence to switch between the two callers. One caller is put on hold while you converse with the other.

**Note:** In order to use the supplementary services provided by your telephone network provider, the Flash time must be set to 300 ms (refer to Chapter 10.5).

**Note:** The caller number display and call waiting function are optional services offered by the telephone network provider. Contact your network provider for further information.

### 7.5 Making a call

1. Enter the phone number (max. 32 digits). A maximum of 12 characters can appear in the display. In the case of longer phone numbers, only the last 12 digits are displayed.

**Note:** Incorrect digits entered can be deleted by briefly pressing the  button. Pressing the  button longer deletes the entire phone number.

2. Press the Call button  and the connection is established.





**Note:** Alternatively, press the  button and then enter the phone number. It is not possible to correct wrongly entered numbers when using this method of dialling.



## - Operation -

### 7.6 Dialling phone numbers stored in the phone book

Phone numbers stored in the phone book (refer to "Storing phone numbers in the phone book" Chapter 8.1) can be dialled quickly and easily.

1. Press the  button. The callers stored in the phone book are displayed in alphabetical order. Use the  and  buttons to scroll through and select an entry stored in the phone book. To select an entry directly, press the corresponding button to enter the first letter of the name required. E.g. to access the name "Peters", press "7" once.
2. Press the  button and the number displayed is dialled.

### 7.7 Displaying the call timer

Ten seconds after a conversation begins, the call timer appears in the display replacing the phone number dialled.

### 7.8 Switching the handset on /off

Press the  button for three seconds to switch the handset on and off.





**Note:** No calls can be received when the handset is switched off.

### 7.9 Adjusting the receiver volume

Press the  or  button during a call to adjust the receiver volume. There are five levels available for selection.





### 7.10 Redialling button



The last ten phone numbers dialled are stored for immediate redialling.

1. Press the  button. The last phone number dialled appears in the display.
2. Press the  or  button to select a phone number from the redialling list.
3. Press the  button and the number displayed is dialled.

**Note:** If the phone number in the redialling list is stored in the phone book, the corresponding name appears in the display.

### 7.10.1 Deleting a number from the redialling list

1. Press the  button and use the  or  button to select the entry to be deleted.
2. Press the  button and confirm by pressing the  button.

**Note:** The redialling list can be deleted completely by pressing the  button for two seconds and then confirming with the  button.

### 7.11 Muting the microphone in the handset

After pressing the  button during a call, the microphone in the handset is deactivated. "Mute" appears in the display. You can then talk to someone else without the caller being able to hear you. The loudspeaker in the handset remains switched on, so that you can continue to hear the caller.

The muting function is deactivated on pressing the  again.

### 7.12 Key lock on/off

If you carry the handset around a lot, you can lock the keypad so that buttons are not inadvertently activated. Calls can still be taken in the normal way even when the key lock function is activated.

1. Press the  button for 3 seconds to activate the key lock function. To switch it off, press the  button twice.

### 7.13 Temporary tone dialling

If you only operate the telephone using the Pulse dialling method, you can still make use of the advantages of the Tone dialling method (e.g.: remote access of the answering machine). During a call, press the  button for four seconds to switch to Tone dialling temporarily. When the call is ended, the telephone automatically switches back to Pulse dialling.



### 7.14 Information on the range

The handset has a range of approx. 50 meters in closed rooms and approx. 300 meters outdoors. In the case of a good connection to the base station, the  icon appears in the display.

**Note:** If the handset is moved too far from the base station, the  icon flashes and acoustic warning signals are issued. Move towards the base station, otherwise the call will be disconnected. If the connection to the handset has been lost, the message "BASE 1" appears in the display.

### 7.15 Locating the handset (paging)



If you have mislaid your handset, you can locate it with the aid of the base station.

1. Press the Paging button . All the handsets registered on the base station ring.
2. To stop the paging function, press the Paging button  on the base station again or any button on the handset.

## 8 Phone Book

The phone book can store 50 phone numbers, each with the associated name. A name can have a maximum of 12 letters. The maximum length of a phone number is 20 digits.

### 8.1 Entering phone numbers in the phone book

1. To do this, press the  button three times.
2. Enter the relevant name and associated phone number. Confirm each respective entry by pressing the  button.

**Note:** Refer to 8.1.2 to enter text.

**Note:** If the name already exists in the phone book, an acoustic signal is issued and "Add" appears in the display again. You have to enter another name.

3. Select the required melody by pressing the  or  button and confirm the selection by pressing . The corresponding melody rings when a call is received from the caller entered. This assignment only functions when your telephone connection and that of the caller implement the caller number display (CLIP function).

### 8.1.1 Information on the phone book



- Always enter the area access code with the phone numbers so that the telephone can also assign incoming local calls to a phone book entry.
- If the memory capacity of 50 phone numbers is reached, the message "MEMORY FULL" appears when an attempt is made to store another number. Phone book entries will then have to be deleted in order create space.

### 8.1.2 Text entry





The digit keys are also labelled with letters for the entry of the respective letters. Pressing the respective key the necessary number of times enables capital letters and digits to be entered.

**Example:** To enter the name "Peter".



Press: 1 x button "7", 2 x button "3", 1 x button "8", 2 x button "3", 3 x button "7"

- To enter a space, press the "1" button once, for a hyphen, press "1" twice.
- To enter the same letter twice, press the relevant button until the letter appears then wait till the cursor automatically skips one position forward.
- Delete any incorrect entries with the  button.
- Press the  or  button to move the cursor accordingly.





### 8.2 Editing entries in the phone book

1. Press the  button twice.
2. Press the  button to select the "MODIFY ENTRY" option.
3. Press the  button to confirm the option and press the  or  button to select the required entry.

**Note:** To select an entry directly, press the corresponding button to enter the first letter of the name required. To select the name "Peters" directly, for example, press the "7" button once.

4. Confirm by pressing the  button and modify the name, phone number and melody as necessary. Confirm each respective modification by pressing the  button.

### 8.3 Deleting stored entries from the phone book

1. Press the  button twice.
2. Press the  button to select the "DELETE ENTRY" option.
3. Press the  button to confirm the option and press the  or  button to select the required entry.

**Note:** The deletion process is cancelled by pressing the  button.

4. Confirm deletion by pressing  twice.

## - Caller Number Display (CLIP Function) -

### 9 Caller Number Display (CLIP Function)

If the caller number display function (CLIP function) is available, the phone number of the caller is displayed when a call is received. If the caller's number is stored in the phone book, the caller's name appears in the display.

If the caller has suppressed the transfer of his phone number, the number is not displayed. The message "WITHHELD" appears in the display.

A total of 40 phone numbers can be stored in the calls list so that you will not miss any calls even if you are absent. When the list is full, the oldest entry is automatically deleted on receipt of a new call. If new phone numbers have been stored in the calls list in your absence, the  icon appears in the display.







**Caution:** The caller number display function (CLIP), as well as the display of date and time, are supplementary services enabled by your telephone network provider. Contact your network provider for further information.



#### 9.1 Calls list

##### 9.1.1 Selecting phone numbers from the calls list

Proceed as follows to view the phone numbers in the calls list in the display:

1. Press the  button. The last number received appears in the display. If the calls list is empty, the message "EMPTY" appears in the display.
2. Use the  or  buttons to select further phone numbers from the calls list. If no further phone numbers are available, an acoustic signal is issued. Two display icons indicate whether the entry in the calls list has already been viewed or whether the entry is new.

Display	Description
	The phone number has already been viewed.
	The phone number has not been viewed.





3. To call back a number displayed in the calls list directly, press the  button.
4. Press the  button to exit from the calls list.

**Note:** Press the  button to call in information on the phone number displayed:

- If the phone number is longer than 12 digits, the remaining digits are displayed.
- Displays the phone number when the caller's name is stored in the phone book.
- Displays the date and time this data was transferred from the caller.





##### 9.1.2 Storing phone numbers from the calls list in the phone book

A phone number stored in the calls list can be transferred directly to the phone book.

1. Press the  button and then use  or  to select the required phone number. Confirm selection by pressing the  button twice.
2. Enter the associated name. Confirm the entry by pressing the  button.

**Note:** Refer to Chapter 8.1.2 for information on entering names.

**Note:** If the name already exists in the phone book, an acoustic signal is issued and the selected phone number reappears in the display.

3. The phone number appears once more in the display. Confirm the entry by pressing the  button.
4. Press the  or  button to select the required melody and confirm the selection by pressing .



##### 9.1.3 Deleting individual numbers from the calls list

1. Press the  button and then use  or  to select the required phone number.

**Note:** The deletion process is cancelled by pressing the  button.



2. Press the  button. Confirm deletion by pressing the  button.

##### 9.1.4 Deleting all the numbers from the calls list







1. Press the  button.
2. Press the  button for three seconds. Confirm deletion by pressing the  button.

## 10 Special Functions









It is possible to adapt certain settings on the handset and base station to suit your personal requirements. Observe the following in this case:

- When you access the menu, the ⇨ icon appears in the display.
- Press the  button to move one menu level back.  
Press the  button longer to stop the process at any point in the menu. The handset returns to standby.
- Every process is automatically cancelled if there is no input within 20 seconds.









### 10.1 Setting the base station volume

1. Press  and use the  button to select menu option "SETUP".
2. Confirm by pressing the  button. "BASE VOLUME" appears in the display.
3. Press  to confirm the entry and use the  or  button to select the required volume.
4. Confirm by pressing the  button.









### 10.2 Setting the base station melody

1. Press  and use the  button to select menu option "SETUP".
2. Press  to confirm the selection and then press the  button to select menu option "BASE MELODY".
3. Press  to confirm the selection and use the  or  button to select the required melody.
4. Confirm by pressing the  button.

### 10.3 Change PIN









1. Press  and use the  button to select menu option "SETUP".
2. Press  to confirm the selection and then press the  button to select menu option "PIN CODE".
3. Confirm by pressing the  button, enter a four-digit PIN (default setting "0000") and confirm by pressing .
4. Enter the new PIN and confirm by pressing .
5. Enter the new PIN again and confirm by pressing .

### 10.4 Tone or Pulse dialling mode

1. Press  and use the  button to select menu option "SETUP".
2. Press  to confirm the selection and then press the  button to select menu option "DIAL MODE".
3. Press  to confirm the selection and use the  or  button to select the required dialling mode.
4. Confirm by pressing the  button.

### 10.5 Setting Recall (Flash time)

There are two Recall times available for selection. Recall 1 corresponds to 100 ms and Recall 2 to 300 ms.

1. Press  and use the  button to select menu option "SETUP".
2. Press  to confirm the selection and then press the  button to select menu option "RECALL".
3. Press  to confirm the selection and use the  or  button to select the required recall time.
4. Confirm by pressing the  button.

## - Special Functions -







### 10.6 Restoring the default settings

This function resets the handset and base station settings to their default status on leaving the factory.

#### Default settings:

Language: English	Name of handset: DSPG
Battery warning signal: On	Automatic answer: On
Range warning signal: On	External ringing melody: 3
Key tone: On	Internal ringing melody: 1
Receiver volume: 3	Ringing volume, handset: 3
PIN: 0000	Ringing melody, base station: 2
Pause: 3 seconds	Ringing volume, base station: 3
Dialling method: DTMF/Tone	Recall (Flash) time: 100 ms

**Note:** The phone book, calls list (CLIP) and all phone numbers in the redialling list are deleted.

1. Press  and use the  button to select menu option "SETUP".
2. Press  to confirm the selection and then press the  button to select menu option "DEFAULT".
3. Confirm the selection by pressing the  button and enter the four-digit PIN (default setting "0000").
4. Confirm by pressing the  button twice.  
The telephone is then reset to its default settings.

### 10.7 Switching the key tone and warning tones on/off

Various tones can be switched on or off.

- **Key tone**











A tone is issued each time a button on the handset is pressed.

- **"Low battery" warning signal**

If the battery capacity is too low, a warning signal is issued to remind you to charge the handset.

- **"Out range" warning signal**









This acoustic warning signal is issued when the handset is moved too far from the base station.

1. Press  and use the  button to select menu option "HANDSET".
2. Confirm by pressing the  button. "BEEP" appears in the display.
3. Press the  button to confirm and use the  or  button to select the "OUT RANGE", "KEY TONE" or "LOW BATTERY" options.
4. Press  to confirm the selection and use the  or  button to select the option "ON" or "OFF".
5. Confirm by pressing the  button.

### 10.8 Setting the handset volume









The ringing volume can be set to a number of levels or switched off completely. If the ringing tone is switched off, incoming calls are indicated by the base station and in the handset display.

Internal and external calls can be assigned different ringing volumes.

1. Press  and use the  button to select menu option "HANDSET".
2. Confirm by pressing  and use the  button to select the menu option "INT RING VOL" or "EXT RING VOL".
3. Press  to confirm the selection and use the  or  button to select the required volume.
4. Confirm by pressing the  button.







### 10.9 Setting the handset ringing melody

Internal and external calls can be assigned different ringing melodies.

1. Press  and use the  button to select menu option "HANDSET".
2. Confirm by pressing  and use the  button to select the menu option "INT MELODY" or "EXT MELODY".
3. Press  to confirm the selection and use the  or  button to select the required melody.
4. Confirm by pressing the  button.







## - Special Functions -

### 10.10 Setting the time



1. Press  and use the  button to select menu option "HANDSET".
2. Press  to confirm the selection and then press the  button to select menu option "CLOCK SET".
3. Confirm by pressing  and enter the current time, in the 24-hour format, using the digit keys.  
Example: 17:53 => 1753 or 6:47 a.m => 0647
4. Confirm by pressing the  button.

### 10.11 Alarm on/off

**Note:** The alarm signal only rings on the handset, not on the base station.  
The alarm also rings even if the ringing volume has been switched off for the handset.









1. Press  and use the  button to select menu option "HANDSET".
2. Press  to confirm the selection and then press the  button to select menu option "ALARM ON".
3. Press  to confirm the selection and use the  or  button to select the option "ON".

**Note:** If you want to switch the alarm off, select the option "OFF" under Point 4 and confirm by pressing the  button.

4. Confirm the selection by pressing the  button and enter the required alarm time in 24-hour format.
5. Confirm by pressing the  button. The alarm is switched on.





### 10.12 Answering calls automatically

Incoming calls can be taken automatically when the handset is removed from the base station. If you prefer to take calls by pressing the  button, switch the automatic answering function off.

1. Press  and use the  button to select menu option "HANDSET".
2. Press  to confirm the selection and then press the  button to select menu option "AUTO ANSWER".
3. Press  to confirm the selection and use the  or  button to select the option "ON" or "OFF".
4. Confirm by pressing the  button.

### 10.13 Changing the name of the handset

When a call is ended, the call time and name of the handset appear alternately in the display. If several handsets are registered on the base station, it is useful to assign each handset with its own unique name.









1. Press  and use the  button to select menu option "HANDSET".
2. Press  to confirm the selection and then press the  button to select menu option "NAME".
3. Confirm the selection by pressing the  button and enter the required name (max. 10 characters).

**Note:** Refer to Chapter 8.1.2 for information on entering text.

4. Confirm by pressing the  button.

### 10.14 Setting the language

Menu texts and messages can appear in the display in various languages.

1. Press  and use the  button to select menu option "HANDSET".
2. Press  to confirm the selection and then press the  button to select menu option "LANGUAGE".
3. Press  to confirm the selection and use the  or  button to select the required language.
4. Confirm by pressing the  button.

## **11 Multiple Handsets**

Up to five handsets can be registered on the base station. Each handset can only be registered on one base station at any particular time.

**Note:** The standardised GAP Standard enables SWITEL handsets and even those from other manufacturers to be integrated in the telephone system. In the same way, a SWITEL handset can be registered on base stations from other manufacturers as long as they comply with the GAP Standard.

The following options are available if several handsets are used:

- Internal calls between the handsets (intercom),
- External calls can be transferred between the handsets.
- Incoming external calls are received on all handsets.
- Conference calls between two handset users and one external caller.



**Note:** If one of the other handsets is currently using the outside line, the **EXT** icon appears in the display. It is not possible to make another external call.

### **11.1 Internal calls (intercom function)**

As soon as several handsets are registered on the base station, they can be used free of charge for internal calls.

1. Press the **INT** button and dial the number of the handset required, e.g. "2".
2. The call can be taken on the handset called.

**Note:** If an external call is received during an internal call, short acoustic signals are issued and the caller's number appears in the display, if available.

3. End the internal call by pressing the  button.
4. Press the  button again to take the external call.

### **11.2 Transferring external calls to another handset**

If you have taken an external call on a handset, the call can be transferred to another handset. To do this, press the **INT** button and then the internal number, e.g. "2", of the handset required.

**Note:** If the handset called does not answer, take the call back by pressing the **INT** button.

After the internal call has been taken by the handset called, the following options are available:

1. **Consultation / Brokering:** You can talk to the party using the other handset and then return the external caller by pressing the **INT** button. You can switch between the external and internal parties as often as necessary.
2. **Transfer call:** By pressing the  button on the first handset, the external call is transferred to the handset called.

### **11.3 Conference calls**

An external call can be transferred to another internal handset for a conference call. This enables two handset users to confer with the external caller at the same time.

1. Establish the required connection to the external caller.
2. Press the **INT** button and dial the number of the second handset required.
3. When the second, internal handset user has taken the call, press the  button and all three parties are connected in a conference call.

**Note:** During a conference call, press the **INT** button to put the external caller on hold. Press the **INT**  buttons in succession to activate the conference facility again.

4. The conference is terminated by one of the handset users ending the call.

## - Multiple Handsets -

### 11.4 Registering and deregistering handsets

#### 11.4.1 Registering handsets

1. Press the Paging button (☎) on the base station for three seconds until two acoustic signals are issued. Register the new handset within 90 seconds.
2. Press the (☰) button on the handset and use the (▼) button to select menu option "REGISTER".
3. Press the (☰) button to confirm the option and press the (▲) or (▼) button to select the menu option "REG BASE".
4. Confirm by pressing (☰) and enter the number of the base station (1 to 4) using the digit keys. If the handset is already connected to a base station, the corresponding number flashes.
5. Confirm by pressing the (☰) button. A search is made for the base station.
6. When the base station is found, enter the PIN (default setting 0 0 0 0).
7. Confirm by pressing the (☰) button. An acoustic signal is issued after a few seconds. The handset is now registered and can be used for internal and external calls.

**Note:** The handset is assigned an internal call number. The handset already registered has the internal call number 1. The second handset registered is assigned the internal call number 2. The internal call number appears on the right-hand side of the display .

#### 11.4.2 Registering other DECT-GAP telephones on the base station

In order to register a DECT-GAP handset from another manufacturer, follow the instructions in the operating manual provided by the original manufacturer and then press the Paging button (☎) on your base station for 3 seconds. Use the PIN to register (default setting: 0000).

#### 11.4.3 Deregistering handsets

A handset can only be deregistered by another handset still registered. It is not possible to complete deregistration using the handset which is to be deregistered.

1. Press (☰) and use the (▼) button to select menu option "SETUP".
2. Press the (☰) button to confirm the option and press the (▲) or (▼) button to select the menu option "DEL HANDSET".
3. Confirm the selection by pressing the (☰) button and enter the PIN (default setting 0000).

**Note:** Press the (☰) button to cancel the process.

4. Confirm the selection by pressing the (☰) button and enter the internal call number of the handset to be deregistered.
5. An acoustic signal is issued after a few seconds in the case of successful deregistration. The handset is now deregistered and can no longer be used for internal and external calls.

### 11.5 Additional base stations

The range of the handset can be increased by using several base stations. To implement the function, all the base stations must be connected to a telephone line socket. Depending on the intended use, each base station can be assigned the same telephone number or each can be assigned a different call number. Pay attention that all the base stations overlap with regard to their range. The handset must be registered on each base station. Please test the range of the handset before starting up a new base station. If a handset is registered on the base stations and automatic dialling of the base station has been activated on the handset (refer to 11.5.1), the handset is automatically transferred to the next base station.

#### 11.5.1 Dialling a base station

1. Press the (☰) button on the handset and use the (▼) button to select menu option "REGISTER"..
2. Press the (☰) button to confirm the option and press the (▲) or (▼) button to select the menu option "SELECT BASE".
3. Confirm by pressing the (☰) button. All the base stations to which the handset is already registered appear in the display. The number of the base station currently active flashes. Use the digit keys to enter the number of the base station to which the handset should be switched.  
Or activate the "AUTO" option by pressing the (▼) button. This option causes the handset to switch to the next base station automatically when the connection to the current base station is interrupted.



## - Troubleshooting -

### 12 Troubleshooting

Should problems arise with the telephone, refer to the following information.

In the case of claims under the terms of guarantee, contact your sales outlet.

Faults	Corrective measures
No telephone calls possible	<ul style="list-style-type: none"><li>- The telephone line is not connected properly or is defective. Only use the telephone line cable supplied.</li><li>- Test whether the telephone connection is in order by using another telephone.</li><li>- The power adaptor plug is not plugged in or there is a complete power failure.</li><li>- The rechargeable standard batteries are empty or defective.</li><li>- The handset is too far from the base station.</li></ul>
Connection is disturbed or cut off	<ul style="list-style-type: none"><li>- The handset is too far from the base station.</li><li>- The base station is in an unsuitable location.</li></ul>
Dialling not possible	<ul style="list-style-type: none"><li>- Dialling mode set incorrectly (refer to Chapter 10.4).</li></ul>
The system no longer responds or is in an undefined state	<ul style="list-style-type: none"><li>- Reset the default settings (refer to Chapter 10.6). Before doing so, disconnect the power adaptor plug briefly from the power socket.</li></ul>
The charging control lamp does not light up	<ul style="list-style-type: none"><li>- Place the handset correctly in the base station, clean the contact surfaces on the handset and the base station with a soft, dry cloth.</li></ul>
The battery icon flashes in the display after a few hours	<ul style="list-style-type: none"><li>- Place the handset in the base station for 14 hours. If this does not help, replace the rechargeable standard batteries.</li></ul>
Display is dark	<ul style="list-style-type: none"><li>- Caused by direct sunlight, allow handset to cool down.</li></ul>

## - Important Information -

### 13 Important Information

#### 13.1 Technical data

Feature	Value
Standard	DECT-GAP
Power supply	Base station, 220/230 V, 50 Hz
Range (outdoors/indoors)	300 m / 50 m
Standby	Up to 110 h
Max. talk time	Up to 10 h
Rechargeable standard batteries	2 x AAA (1.2V / 550 mAh)
Dialling method	Tone or Pulse
Permissible ambient temperature	10°C to 30°C
Permissible relative humidity	20% to 75%
Recall (Flash) times	100 ms or 300 ms

DECT: **D**igital **E**uropean **C**ordless **T**elephone = Standard for cordless telephones.

GAP: **G**eneric **A**ccess **P**rofile = Standard for the interoperation of handsets and base stations from other manufacturers.

#### 13.2 Guarantee

SWITEL equipment is produced and tested according to the latest production methods. The implementation of carefully chosen materials and highly developed technologies ensure trouble-free functioning and a long service life. The terms of guarantee do not apply where the cause of equipment malfunction is the fault of the telephone network operator or any interposed private branch extension system. The terms of guarantee do not apply to the standard batteries or power packs used in the products. The period of guarantee is 24 months from the date of purchase.

All deficiencies resulting from material or production faults which occur during the period of guarantee will be eliminated free of charge. Rights to claims under the terms of guarantee are annulled following intervention by the purchaser or third parties. Damage caused as a result of improper handling or operation, incorrect positioning or storing, improper connection or installation, Acts of God or other external influence are not covered by the terms of guarantee. In the case of complaints, we reserve the right to repair or replace defect parts or provide a replacement device. Replacement parts or devices become our property. Rights to compensation in the case of damage are excluded where there is no evidence of intent or gross negligence by the manufacturer.

If your device shows signs of defect during the period of guarantee, please return it to the sales outlet in which you purchased the SWITEL device together with the purchase receipt. All rights to claims under the terms of guarantee in accordance with this agreement must be asserted exclusively with regard to your sales outlet. Two years after the purchase and transfer of our products, claims under the terms of guarantee can no longer be asserted.



**- Declaration of conformity -**

WE TELGO AG  
OF Route d'Englisberg 17  
CH-1763 Granges-Paccot

Declare under our own responsibility that the product

MODEL: D6026  
DESCRIPTION: DECT Cordless telephone

Is in conformity with directives: R&TTE Directive (1999/5/EC)  
COMPLIANCE IS ACHIEVED BY CONFORMITY TO THE FOLLOWING:

EN 301 406                                      EN 301 489-1/6                                      EN 60950-2000

TEST REPORT NUMBER:

ET 93B-08-028	EN 301489-1 v 1.4.1	ET 93S-11-064-01
ET 93B-11-014	ET 93B-11-014-1	ET 93S-11-064-02
ET 93B-08-028-1	ET 93B-11-014-2	EN 301406 v 1.5.1
		EN 301489-6 v1.2.1

AUTHORISED BY:

Signed:

Name (printed):

Position in company:

Date of issue:



Selim Dusi

Managing Director

27.06.2005

Copies of this document will be held on file for a period of 10 years after the last production.



Supplier: TELGO AG, Route d'Englisberg 17,  
CH-1763 Granges-Paccot  
Product: D6026

This product is intended for connection to analogue PSTN lines within Switzerland.

However, due to differences between the individual PSTNs provided in the different countries, the approval does not, of itself, give an unconditional assurance of successful operation on every PSTN network termination point.