



# BigTel 50 alarm plus

Bedienungs-  
anleitung

User Guide

Mode  
d'emploi

Istruzioni  
d'uso



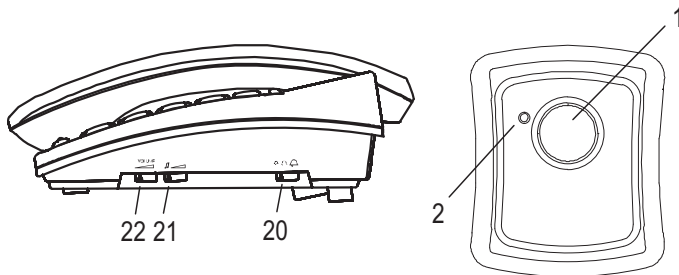
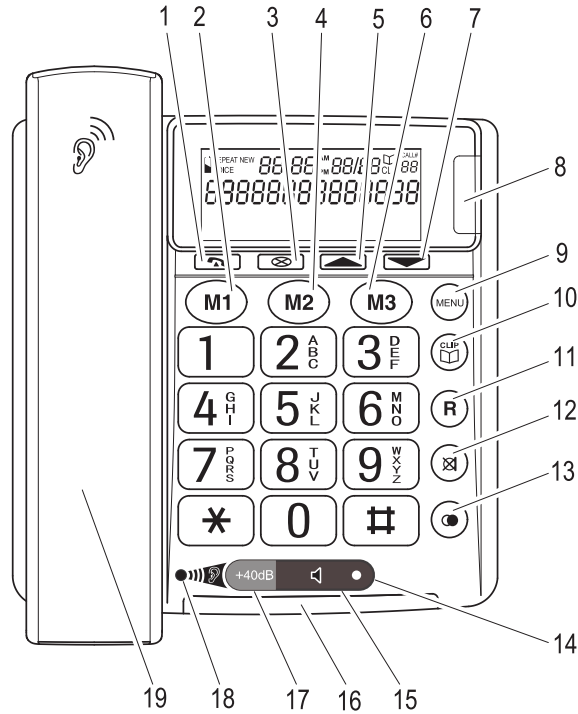

**Telefon**

- 1 Wähltaste
- 2 Direktwahltaste M1  
(Notrufnummer 1)
- 3 Löschen
- 4 Direktwahltaste M2  
(Notrufnummer 2)
- 5 Aufwärts blättern
- 6 Direktwahltaste M3  
(Notrufnummer 3)
- 7 Abwärts blättern
- 8 LED Notrufgeber /  
Anzeige neuer Anruf (s. S. 22)
- 9 Menü-Taste
- 10 Anrufliste / Telefonbuch
- 11 R-Taste
- 12 Mikrofon stummschalten
- 13 Wahlwiederholung
- 14 LED „Freisprechen ein“
- 15 Taste Freisprechen
- 16 LED „Telefon klingelt“
- 17 Hörerlautstärke verstärken
- 18 LED „Hörerlautstärke verstärkt“

- 19 Einstellung Hörerlautstärke (verdeckt unter Hörer)
- 20 Einstellung Klingellautstärke
- 21 Einstellung Klang
- 22 Einstellung Freisprechlautstärke

**Notrufgeber**

- 1 Automatischen Notruf starten
- 2 LED Batteriekapazität

<b>Telefon in Betrieb nehmen.....</b>	<b>4</b>
Verpackungsinhalt prüfen .....	4
Anschließen des Telefons .....	5
Wandmontage.....	7
Displayanzeigen .....	8
Datum/Uhrzeit einstellen.....	10
Sprache einstellen .....	10
 <b>Telefonieren .....</b>	 <b>11</b>
Eine Rufnummer von Hand eingeben und wählen .....	11
Gespräch beenden.....	11
Einen Anruf annehmen .....	12
Lauthören ein-/ausschalten.....	12
Verstärkung der Hörerlautstärke einschalten .....	13
Hörerlautstärke einstellen .....	13
Klingellautstärke einstellen.....	13
Klang des Hörers einstellen .....	13
Freisprechlautstärke einstellen .....	14



Mikrofon stummschalten .....	14
Eine Rufnummer mit Wahlwiederholung wählen .....	14
Eine Rufnummer aus der Anrufliste wählen .....	14
Eine Rufnummer aus dem Telefonbuch wählen.....	15
Eine Direktwahl-Rufnummer wählen.....	16
Nummern verketteten und übertragen.....	17
<b>Telefon einstellen .....</b>	<b>18</b>
Telefonbuch .....	18
Anrufliste .....	22
Notrufgeber .....	25
Einstellungen.....	32
Spezielle Verwendung .....	34

**Anhang.....35**

- Sicherheitshinweise.....35
- Bestimmungsgemäße Verwendung .....35
- Aufstellungsort.....35
- Netzgerät .....36
- Hörgeräte kompatibel.....36
- Entsorgung .....37
- Fehlersuche und -behebung .....38
- Pflegehinweise .....39
- Garantie .....39
- Konformitätserklärung .....40

# Telefon in Betrieb nehmen

**Wichtig: Lesen Sie bitte zuerst die Sicherheitshinweise auf der Seite 35, bevor Sie das Telefon in Betrieb nehmen.**

**Achtung: Dieses Telefon kann sehr hohe Lautstärken wiedergeben, wenn der Verstärker aktiviert ist und der Lautstärkereglер auf Maximum steht. Große Vorsicht ist geboten beim Wechsel zwischen Benutzern mit normalem Gehör und vermindertem Gehör.**

## Verpackungsinhalt prüfen

Zum Lieferumfang gehören:

- 1 Telefon (Tischgerät)
- 1 Netzteil
- 1 Hörer
- 1 Hörerspiralkabel
- 1 Notrufgeber
- 1 Telefonanschlusskabel
- 4 Batterien AA 1,5 V (für Tischgerät)
- 1 Batterie Typ 23A, 12 V (bereits im Notrufgeber eingesetzt)
- 1 Wandmontagehalterung
- 1 Bedienungsanleitung

**Wichtig:**

- **Verwenden Sie nur das mitgelieferte Netzteil.**
- **Verwenden Sie nur das mitgelieferte Telefonanschlusskabel, da das Gerät mit einem anderen Telefonanschlusskabel eventuell nicht funktioniert.**

## Anschließen des Telefons

Um **alle Funktionen** des Telefons wie z. B. **Freisprechen** und **Verstärkung der Hörerlautstärke** nutzen zu können, ist eine **Stromversorgung notwendig**. Diese kann mit Hilfe des mitgelieferten Netzteils und durch Batterien erfolgen.

1. Legen Sie die Batterien in das geöffnete Batteriefach ein. Verwenden Sie nur Batterien des Typs AA 1,5 V.  
Achten Sie auf die richtige Polung!  
Schließen Sie das Batteriefach.

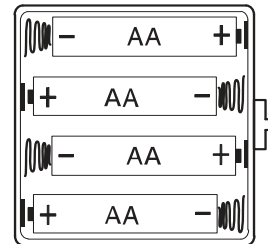

Achten Sie immer darauf, dass das Telefon nicht mit dem Telefonanschluss und/oder Netzanschluss verbunden ist, wenn Sie die Batterien einlegen oder austauschen.



2. Schließen Sie das Telefon wie auf der Skizze abgebildet an. Verwenden Sie nur das mitgelieferte Telefonanschlusskabel, da das Gerät mit einem anderen Telefonanschlusskabel eventuell nicht funktioniert.

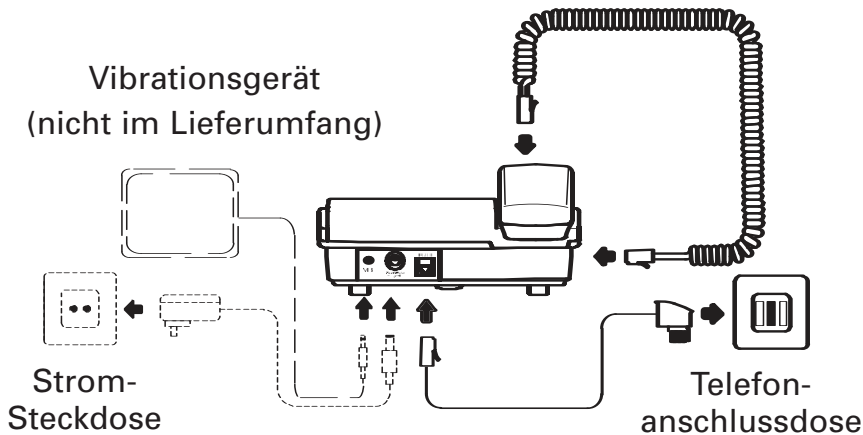

**Zur Verwendung eines geeigneten Vibrationsgeräts stecken Sie den Stecker des Vibrationsgeräts in die Buchse „Vibrat.“ des Telefons. Es sind keine weiteren Einstellungen notwendig. Das Vibrationsgerät gehört nicht zum Lieferumfang.**

## Wandmontage

Ihr Telefon ist zur Wandmontage geeignet. Für die Befestigung des Telefons benötigen Sie zwei Schrauben.

Führen Sie die Führungsnasen (1) der Wandmontagehalterung (2) in die Führungsnuten (3) auf der Rückseite des Telefons ein. Schieben Sie die Wandmontagehalterung (2) 10 mm nach oben, bis sie hörbar einrastet.

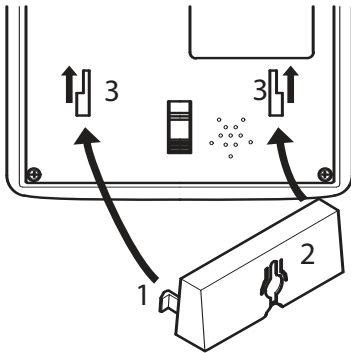

**Warnung: Im Bereich der zu bohrenden Löcher dürfen sich keine Leitungen (Kabel, Rohre usw.) befinden.**

Bohren Sie zwei Löcher im Abstand der vorgesehenen Aufhängungen und lassen Sie die Schrauben 5 mm aus der Wand herausstehen. Setzen Sie das Telefon an den Aufhängungen auf die Schrauben und schieben Sie es etwas nach unten.

Drehen Sie die Höreraufhängung (4) in der Telefonhörerablage um 180°, damit Sie den Telefonhörer einhängen können.

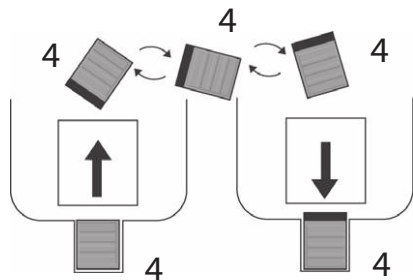

## Displayanzeigen



Tauschen Sie die Batterien aus.

14:45

Anzeige der Uhrzeit.

11/06

Anzeige des Datum.



Sie befinden sich im Telefonbuch.

**CLIP**

Sie befinden sich in der Anrufliste.

**NEW**

Der aktuelle Eintrag in der Anrufliste ist neu.

**REPEAT**

Der Anrufer hat mehrmals angerufen.

CALLS  
**01**

Anzeige der Positionsnummer in der Anrufliste.

**TOTAL: XX**

Sie haben XX Einträge in der Anrufliste.

**NEU: XX**

Sie haben XX neue Einträge in der Anrufliste.

**VOICE**

















(blinkt) Sie befinden sich im Aufnahmemodus (s. S. 20, 26).

(leuchtet konstant) Für diesen Telefonbucheintrag wurde ein Name angenommen.



**+**

Eine Notrufnummer wird gewählt (s. S. 28).

## Datum/Uhrzeit einstellen

- Drücken Sie .
- Wählen Sie mit  /  ZEIT/DATUM und drücken Sie .
- Geben Sie mit  /  die Stunden ein und drücken Sie .
- Geben Sie mit  /  die Minuten ein und drücken Sie .
- Geben Sie mit  /  den Monat ein und drücken Sie .
- Geben Sie mit  /  den Tag ein und drücken Sie .
- Verlassen Sie das Menü mit .

## Sprache einstellen

- Drücken Sie .
- Wählen Sie mit  /  SPRACHE und drücken Sie .
- Wählen Sie mit  /  eine Sprache und drücken Sie .
- Verlassen Sie das Menü mit .

Weitere Einstellungen finden Sie im Kapitel „Einstellungen“, s. S. 32



# Telefonieren

## Eine Rufnummer von Hand eingeben und wählen

Um jemanden anzurufen können Sie:

- zuerst den Hörer abheben und dann die Rufnummer eingeben.
- eine Rufnummer eingeben und dann den Hörer abheben.

oder

- eine Rufnummer eingeben und die Taste  oder Taste  drücken.  
Der Lautsprecherbetrieb wird eingeschaltet und die Rufnummer gewählt (für Lautsprecherbetrieb Netzteil/Batterien erforderlich).
- Während des Gesprächs wird die Gesprächsdauer angezeigt.

## Gespräch beenden

Um ein Gespräch zu beenden können Sie:

- den Hörer auflegen.

oder

- die Taste  drücken, wenn Sie das Gespräch über den Lautsprecher geführt haben (die rote Lampe in der Taste leuchtet).

## Einen Anruf annehmen

Heben Sie den Hörer ab oder drücken Sie die Taste .

## Lauthören ein-/ausschalten

Während eines Telefongesprächs, das Sie mit dem Hörer führen, können Sie auf Lautsprecherbetrieb umschalten (Netzteil/Batterien erforderlich).

Drücken Sie dazu die Taste  und legen Sie anschließend den Hörer auf.

Wollen Sie das Gespräch mit dem Hörer fortsetzen, heben Sie einfach den Hörer ab.

### **Beachten Sie bitte:**

- Während des Lautsprecherbetriebs wird Ihre Sprache vom Mikrofon im Tischgerät übertragen. Sprechen Sie mit einem Abstand von bis zu 50 cm in Richtung der Vorderseite des Tischgerätes.
- Laute Geräusche in Ihrer Umgebung werden ebenfalls übertragen und können die Verständlichkeit Ihrer Sprache bei Ihrem Gesprächspartner beeinträchtigen.

## Verstärkung der Hörerlautstärke einschalten

Die Hörerlautstärke kann auf +40 dB verstärkt werden (Netzteil/Batterien erforderlich). Drücken Sie dazu die Taste . Die „Ein“-Anzeige  leuchtet.

**Warnung: Diese Lautstärke kann Schäden bei Menschen mit normalem Gehör verursachen!**

## Hörerlautstärke einstellen

Sie können die Hörerlautstärke mit einem Drehregler (19) anpassen (siehe Ausklappseite vorn).

## Klingellautstärke einstellen

Sie können die Klingellautstärke mit einem Schieberegler (20) anpassen (siehe Ausklappseite vorn).

## Klang des Hörers einstellen

Sie können den Klang des Hörers mit einem Schieberegler (21) anpassen, wenn die Verstärkung auf +40 dB aktiviert ist (siehe Ausklappseite vorn).



## Freisprechlautstärke einstellen

Sie können die Freisprechlautstärke mit einem Schieberegler (22) anpassen (siehe Ausklappseite vorn).

## Mikrofon stummschalten



Sie können während eines Telefongesprächs das Mikrofon des Telefons aus- und einschalten.

 halten: Mikrofon ausschalten

 loslassen: Mikrofon wieder eingeschaltet

## Eine Rufnummer mit Wahlwiederholung wählen





Das Telefon speichert die zuletzt gewählte Telefonnummer.

- Heben Sie zuerst den Hörer ab oder drücken Sie die Taste  und dann die Taste .



## Eine Rufnummer aus der Anrufliste wählen

In der Anrufliste werden Anrufe gespeichert, die Sie nicht angenommen haben.

Weitere Information finden Sie im Abschnitt „Anrufliste“ auf der Seite 22.





- Heben Sie zuerst den Hörer ab oder drücken Sie die Taste , wählen Sie dann mit den Tasten  und  den gewünschten Eintrag aus und drücken Sie  .

oder

- Wählen Sie zuerst mit den Tasten  und  den gewünschten Eintrag aus und drücken Sie  . Der Lautsprecher wird eingeschaltet. Wenn Sie das Gespräch über den Hörer fortsetzen wollen, heben Sie ihn ab. Der Lautsprecher wird dann abgeschaltet.





## Eine Rufnummer aus dem Telefonbuch wählen

Informationen zum Erstellen und Speichern von Telefonbucheinträgen finden Sie im Abschnitt „Telefonbuch“ auf der Seite 18.

- Heben Sie zuerst den Hörer ab oder drücken Sie die Taste .
- Drücken Sie die Taste , wählen Sie mit den Tasten  und .





den gewünschten Eintrag aus und drücken Sie .

oder





- Drücken Sie zuerst die Taste , wählen Sie mit den Tasten  und  den gewünschten Eintrag aus und drücken Sie . Der Lautsprecher wird eingeschaltet. Wenn Sie das Gespräch über den Hörer fortsetzen wollen, heben Sie ihn ab. Der Lautsprecher wird dann abgeschaltet.

## Eine Direktwahl-Rufnummer wählen

Sie können die Direktwahltasten M1, M2 oder M3 als normale Direktwahl oder als Speicherplätze für den automatischen Notruf nutzen. Wie Sie die Direktwahl- / Notrufnummern speichern finden Sie im Abschnitt „Notrufnummern/Direktwahlnummern speichern“ auf der Seite 27.

- Heben Sie zuerst den Hörer ab oder drücken Sie die Taste .
- Drücken Sie kurz die Notruftaste ,  oder .





oder

- Drücken Sie zuerst kurz die Notruftaste  ,  oder  .
- Heben Sie dann den Hörer ab oder drücken Sie die Taste  .

**Hinweis: Die gespeicherten Rufnummern auf den Direktwahl- / Notruftasten können nicht gelöscht werden. Beim Speichern neuer Rufnummern werden die alten Einträge überschrieben.**

## Nummern verketteten und übertragen

Die Funktion findet Anwendung bei komplexeren Telefondiensten, wie z. B. Telefonbanking, Call by Call oder Calling-Card-Verfahren. Sie können mehrere gespeicherte Nummern während einer bestehenden Verbindung aus dem Telefonbuch übertragen. Übertragungen von Nummern aus dem Telefonbuch können Sie mit manuellen Nummereingaben kombinieren. Sie können während einer Verbindung beliebig viele Einträge aus dem Telefonbuch verketteten und übertragen.

- Drücken Sie während einer bestehenden Verbindung die Taste  , wählen Sie mit den Tasten  und  den gewünschten Eintrag aus und drücken Sie  .

# Telefon einstellen

## Telefonbuch

Im Telefonbuch können Sie 30 Rufnummern mit den dazugehörigen Namen speichern.

- Geben Sie bei allen Rufnummern immer die Vorwahl mit ein, damit auch eingehende Ortsgespräche einem Telefonbucheintrag zugeordnet werden können.
- Ist die Speicherkapazität erschöpft, zeigt das Display beim nächsten Speichern die Meldung `SPEICHER VOLL`. Um wieder Platz zu schaffen, müssen Sie zuerst einen anderen Eintrag löschen.
- Die Telefonbucheinträge sind alphabetisch geordnet. Um direkt zum gewünschten Telefonbucheintrag zu gelangen, drücken Sie den entsprechenden Anfangsbuchstaben.

## Namen eingeben









Die Zifferntasten sind mit Buchstaben beschriftet. Durch mehrmaliges Drücken der entsprechenden Taste können Buchstaben, Ziffern und Sonderzeichen eingegeben werden.

Leerzeichen geben Sie mit der Taste  ein.

Zeichen löschen können Sie mit  .







Um den gleichen Buchstaben zweimal hintereinander einzugeben, drücken Sie den entsprechenden Buchstaben erst einmal. Warten Sie dann, bis der Cursor (blinkender Strich) eine Stelle weitersprungen ist. Geben Sie dann den Buchstaben erneut ein.

### Telefonbucheinträge erstellen

- Drücken Sie .
- Wählen Sie mit  und  **NUMMER SPEICHERN** und drücken Sie .
- Geben Sie die Rufnummer ein und drücken Sie .
- Geben Sie den Namen ein und drücken Sie .
- Wenn Sie gleich einen gesprochenen Namen (wird bei Aufruf im Telefonbuch bzw. bei Anruf der betreffenden Rufnummer angesagt) eingeben wollen, drücken und halten Sie .
- Sprechen Sie den Namen für diesen Eintrag und lassen Sie anschließend die Taste  wieder los.

**Hinweis: Sie können den gesprochenen Namen auch später zu einem Telefonbucheintrag hinzufügen (s. u.).**

## Telefonbucheinträge ändern

- Drücken Sie zuerst , wählen Sie dann mit  und  den gewünschten Eintrag aus.
- Drücken Sie  für ca. 3 Sekunden und bestätigen Sie **BEARBEITEN** mit .
- Geben Sie ggf. die neue Rufnummer ein und drücken Sie .
- Geben Sie ggf. den neuen Namen ein und drücken Sie .

## Gesprochenen Namen hinzufügen

Sie können Sie zu jedem Telefonbucheintrag einen Namen aufnehmen. Wenn Sie dann ein Anruf von dieser Rufnummer eintrifft oder Sie den betreffenden Eintrag im Telefonbuch auswählen, wird Ihre Aufnahme wiedergegeben und Sie hören, wer Sie anruft bzw. welchen Eintrag Sie ausgewählt haben.

- Drücken Sie .
- Wählen Sie mit  und  **NAMEN AUFNEHMEN** und drücken Sie .

- Wählen Sie dann mit  und  den gewünschten Eintrag aus.
- Drücken und halten Sie  während Sie den Namen sprechen.



**Hinweis: Wenn Sie die Taste nicht loslassen, wird die Aufnahme nach 3 Sekunden automatisch beendet.**

- Zum Verlassen des Menüs drücken Sie .



### Gesprochenen Namen löschen

- Drücken Sie .
- Wählen Sie mit  und  **NAMEN AUFNEHMEN** und drücken Sie .
- Wählen Sie dann mit  und  den gewünschten Eintrag aus.
- Drücken Sie während der Wiedergabe .







### Einzelne Telefonbucheinträge löschen

- Drücken Sie zuerst , wählen Sie dann mit  und  den gewünschten Eintrag aus.



- Drücken Sie . Im Display erscheint LOSCHEN?.
- Drücken Sie  für ca. 4 Sekunden. Der Eintrag wird gelöscht.
- Zum Abbrechen des Löschvorgangs drücken Sie .

## Alle Telefonbucheinträge löschen

- Drücken Sie zuerst , wählen Sie dann mit  und  einen beliebigen Eintrag aus.
- Drücken Sie  für ca. 4 Sekunden.  
Im Display erscheint ALLE LOSCHEN?.
- Drücken Sie  erneut für ca. 4 Sekunden.
- Zum Abbrechen des Löschvorgangs drücken Sie .

## Anrufliste

**Hinweis: Um diese Funktion nutzen zu können, muss an Ihrem Anschluss die Rufnummernübertragung verfügbar sein. Fragen Sie Ihren Netzbetreiber nach weiteren Informationen.**





Steht die Rufnummernübertragung (CLIP) an Ihrem Anschluss zur Verfügung, wird Ihnen die Rufnummer des Anrufers bzw. der Name, wenn es für diese Rufnummer einen Telefonbucheintrag gibt, bereits angezeigt bzw. angesagt, wenn das Telefon klingelt. Hat der Anrufer das Übertragen seiner Rufnummer unterdrückt oder ist sie aus anderen Gründen nicht verfügbar, wird eine entsprechende Meldung angezeigt. Die Rufnummer kann dann nicht angezeigt und somit auch nicht in der Anrufliste gespeichert werden.

Im Ruhedisplay erkennen Sie, wieviele Anrufe in der Anrufliste sind und wieviele davon NEU (noch nicht angesehen) sind. Insgesamt werden 64 Rufnummern in einer Anrufliste gespeichert. Die blinkende rote LED zeigt an, dass neue Anrufe in der Anrufliste gespeichert wurden. **Diese LED blinkt so lange wie noch nicht angesehene Einträge vorhanden sind. Um das Blinken zu stoppen drücken Sie wiederholt auf die Taste** .

### Rufnummer in der Anrufliste anzeigen

- Wählen Sie mit  und  einen Eintrag aus.

### Rufnummer aus der Anrufliste ins Telefonbuch speichern

- Wählen Sie mit  und  einen Eintrag aus.
- Drücken Sie  für ca. 3 Sekunden und bestätigen Sie **KOPIE  
SPEICHER** mit .

- Die Rufnummer wurde ohne Namen im Telefonbuch gespeichert. Geben Sie jetzt einen Namen für die Rufnummer ein (s. „Telefonbucheinträge ändern“).

**Hinweis: Sobald die Rufnummer im Telefonbuch mit einem Namen gespeichert wurde, erscheint in der Anrufliste zusätzlich der eingegebene Name.**

### Einzelne Einträge löschen

- Wählen Sie mit  und  einen Eintrag aus.
- Drücken Sie . Im Display erscheint LOSCHEN?.
- Drücken Sie  für ca. 4 Sekunden. Der Eintrag wird gelöscht.

### Komplette Anrufliste löschen

- Wählen Sie mit  und  einen beliebigen Eintrag aus.
- Drücken Sie  für ca. 4 Sekunden.

Im Display erscheint ALLE LOSCHEN?.

- Drücken Sie  erneut für ca. 4 Sekunden.

**Hinweis: Kontrollieren Sie vor dem Löschen der Rufnummern, ob die Einträge angesehen wurden.**

## Notrufgeber

Über den Notrufgeber können Sie Hausnotrufdienste oder Personen zu Hilfe rufen.

**Hinweis: Es gibt viele geeignete Hausnotrufdienste, wie z. B. "Rotes Kreuz", "Malteser Hilfswerk" und "Die Johanniter". In manchen Ländern sind Hausnotrufdienste kostenpflichtig.**

**Sie können dieses Gerät auch als private Notrufeinrichtung in der Familie nutzen.**

## Notrufansage

Es befindet sich bereits eine voreingestellte Notrufansage auf Ihrem Telefon.

Diese Notrufansage können Sie durch eine eigene Notrufansage ersetzen.

Wenn Sie einen automatischen Notruf starten, werden die gespeicherten Rufnummern auf den Tasten **M1**, **M2** und **M3** automatisch angerufen. Die Notrufansage wird solange wiedergegeben, bis Ihr Notruf von einer dieser Personen

mit der Taste „0“ angenommen wird. Aus diesem Grund müssen Sie Ihre eigene Notrufansage grundsätzlich mit dem Satz **“Nehmen Sie diesen Notruf mit der Taste 0 entgegen!”** beenden.

**Hinweis: Achten Sie in Ihrer Ansage darauf, dass der Angerufene erkennt, von wem der Notruf kommt. Weisen Sie in Ihrer Ansage deutlich darauf hin, dass es sich um einen Notruf handelt und Sie Hilfe benötigen.**

### Notrufansage aufnehmen

- Drücken Sie .
- Wählen Sie mit  /  ANSAGE AUFNEHMEN und drücken Sie .
- Drücken und halten Sie  während Sie die Ansage sprechen.
- Zum Beenden der Ansage lassen Sie  wieder los.

### Notrufansage anhören









- Drücken Sie .
- Wählen Sie mit  /  ANSAGE PRÜFEN und drücken Sie .

## Notrufansage löschen

- Drücken Sie .
- Wählen Sie mit  /  ANSAGE PRUFEN und drücken Sie .
- Drücken Sie während des Abspielens . Die Ansage wird gelöscht.

## Notrufnummern / Direktwahlnummern speichern

Sie können die Direktwahltasten M1, M2 und M3 als normale Direktwahl oder als Speicherplätze für den automatischen Notruf nutzen.

- Drücken Sie .
- Wählen Sie mit  /  NUMMER SPEICHERN und drücken Sie .
- Geben Sie die Rufnummer (max. 22 Ziffern) ein und drücken Sie .
- Wählen Sie eine Direktwahltaste ,  oder  aus und drücken Sie .







**Hinweis: Die gespeicherten Rufnummern auf den Direktwahltasten können nicht gelöscht werden. Beim Speichern neuer Rufnummern werden die alten Einträge überschrieben.**

## Automatischer Notruf

Der automatische Notruf kann durch Drücken und Halten der Tasten **M1**, **M2** oder **M3** am Telefon oder den Notrufgeber gestartet werden. Haben Sie keine Rufnummer auf einer der Tasten **M1**, **M2** oder **M3** gespeichert, wird keine Rufnummer gewählt, sondern ein lautes Warnsignal vom Telefon wiedergegeben.

**Hinweis: Achten Sie darauf, dass sich der Notrufgeber in Reichweite des Telefons befindet.  
Es sollte sich immer eine volle Batterie im Notrufgeber befinden.**

## Automatischer Notruf über das Telefon

- Drücken Sie  ,  oder  für ca. 5 Sekunden um den automatischen Notruf zu starten.
- Drücken Sie  oder erneut  ,  oder  für ca. 5 Sekunden um den automatischen Notruf zu beenden.

## Automatischer Notruf über den Notrufgeber

1. Halten Sie für 5 Sekunden die Taste (1) am Notrufgeber gedrückt, um den automatischen Notruf zu starten.
2. Halten Sie erneut die Taste am Notrufgeber für 5 Sekunden gedrückt, um den automatischen Notruf zu beenden.

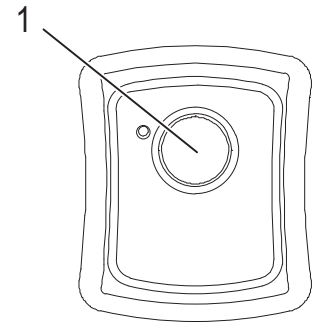

## Ablauf des automatischen Notrufs

Ihr Telefon verhält sich beim Starten des automatischen Notrufs folgendermaßen:

1. Der Lautsprecher des Notruftelefons schaltet sich ein. Ein Signal "Notruf aktiv" ist 15 Sekunden lang zu hören.
2. Anschließend ist das Freizeichen zu hören und die gespeicherten Rufnummern der Tasten **M1**, **M2** und **M3** werden automatisch, nacheinander im Abstand von ca. 60 Sekunden gewählt. Die aufgezeichnete Notrufansage wird in einer Endlosschleife abgespielt.
3. Sobald der Anruf von einer Person entgegengenommen wird, hört diese die Notrufansage. Durch Betätigen der **Taste „0“** stoppt die Person die Notrufansage. Es kann jetzt für 3 Minuten telefoniert werden. In dieser Zeit bleibt am Notruftelefon das Freisprechen aktiv.



4. Nach Ablauf der 3 Minuten wird die Verbindung unterbrochen. Es wird, wie oben beschrieben, erneut versucht, zu den gespeicherten Rufnummern der Tasten **M1**, **M2** und **M3** eine Verbindung herzustellen.
5. Wenn das Gespräch vor Ablauf der 3 Minuten unterbrochen oder wenn aufgelegt wurde, wird weiterhin versucht, eine Verbindung zu den nächsten gespeicherten Rufnummern herzustellen, bis alle 3 Nummern gewählt wurden. Am Notruftelefon ist zunächst das Besetztsignal zu hören.

**Hinweis: Um einen Notruf zu beenden, halten Sie erneut die Taste am Notrufgeber oder M1, M2, M3 für 5 Sekunden gedrückt.**

### **Batterie Notrufgeber prüfen**

1. Halten Sie die Taste (1) am Notrufgeber kurz gedrückt. Die LED (2) leuchtet.
2. Leuchtet die LED (2) beim Halten der Taste nicht mehr, tauschen Sie die Batterie aus.

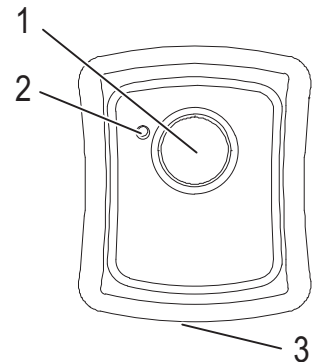



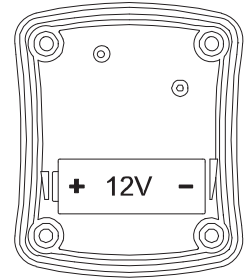

## Batterie austauschen



1. Entfernen Sie die Schraube auf der Rückseite des Notrufgebers mit einem kleinen Kreuzschraubendreher.
2. Öffnen Sie, mit Hilfe eines kleinen Schraubendrehers, an der Einkerbung (3) das Gehäuse.
3. Tauschen Sie die Batterie aus. Verwenden Sie nur Batterien des gleichen Typs. Achten Sie auf die richtige Polung!
4. Schließen Sie das Gehäuse.



## Einstellungen

Sie können verschiedene Einstellungen an Ihrem Telefon vornehmen.

- Drücken Sie . Das Menü wird geöffnet.
- Gehen Sie mit  und  zum gewünschten Menüpunkt und drücken Sie , um das jeweilige Untermenü zu öffnen.

LCD KONTRAST (1-5)      Einstellung ändern mit  und  oder , um die aktuelle Einstellung zu behalten.

ZEIT/DATUM      siehe Seite 10.

NUMMER SPEICHERN      siehe Seite 19, 27.

NAMEN AUFNEHMEN      siehe Seite 20.

ANSAGE AUFNEHMEN      siehe Seite 26.

ANSAGE PRUFEN      siehe Seite 26.

SPRACHE      siehe Seite 10. Die Ansagen und Displaytexte des Telefons sind in 4 Sprachen einstellbar.

## FLASH

Für die Nutzung der Leistungsmerkmale im analogen Netz ist die Flashzeit von 100 ms richtig. Es kann allerdings z. B. beim Betrieb an einer Telekommunikationsanlage notwendig sein, eine Flashzeit von 300 ms einzustellen. Nähere Informationen dazu entnehmen Sie bitte der Bedienungsanleitung der Anlage.

## KLINGELTON (1-3)

Einstellung ändern mit  und  oder , um die aktuelle Einstellung zu behalten.

## STIMME

Das Drücken einiger Tasten wird zusätzlich von einer Stimme begleitet. Diese Stimme können Sie ein- und ausschalten.

- Drücken Sie  um das Menü zu verlassen.

## Spezielle Verwendung

### Betrieb an einer Telefonanlage

Betreiben Sie Ihr Telefon an einer Telefonanlage (wenn Sie z. B. eine „0“ wählen müssen um eine Amtsleitung zu belegen) benutzen Sie für die Vermittlungsfunktionen, die Ihnen die Anlage bietet, die Taste  .

Zur Länge des von Ihrer Anlage benötigten Flash-Signals sehen Sie bitte in der Dokumentation zu Ihrer Telefonanlage nach.

### Wahlpause einfügen

Wenn Sie innerhalb einer Telefonnummer eine Wahlpause eingeben wollen, drücken Sie an der entsprechenden Stelle die Taste  .

### Netzbetreiber-Dienste nutzen

Sie können mit Ihrem Telefon auch Netzbetreiber-Dienste wie „Anklopfen“ oder „Konferenz“ nutzen. Bitte erkundigen Sie sich bei Ihrem Netzbetreiber nach den Einzelheiten.

# Anhang

## Sicherheitshinweise

Lesen Sie diese Bedienungsanleitung sorgfältig durch und bewahren Sie sie gut auf.

## Bestimmungsgemäße Verwendung

Dieses Telefon ist geeignet für das Telefonieren innerhalb eines analogen Telefonnetzes. Jede andere Verwendung gilt als nicht bestimmungsgemäß. Eigenmächtige Veränderungen oder Umbauten sind nicht zulässig. Öffnen Sie das Gerät in keinem Fall selbst und führen Sie keine eigenen Reparaturversuche durch.

## Aufstellungsort

Beachten Sie bitte:

- Stellen Sie Ihr Telefon auf eine flache, ebene Oberfläche bzw. befestigen Sie es an der Wand.
- Verlegen Sie die Anschlusskabel so, dass keine Stolperfallen entstehen.
- Stellen Sie sicher, dass die Steckdose mit dem Netzgerät jederzeit zugänglich ist, um das Gerät schnell vom Netz trennen zu können.
- Halten Sie einen Abstand von ca. 1 Meter zu anderen elektronischen Geräten ein, um eine gegenseitige Beeinflussung zu vermeiden.

- Vermeiden Sie Belastungen durch Rauch, Staub, Erschütterungen, Chemikalien, Feuchtigkeit, Hitze oder direkte Sonneneinstrahlung.

## Netzgerät

**Achtung: Verwenden Sie nur das mitgelieferte Netzteil, da andere Netzteile das Telefon beschädigen können. Sie dürfen den Zugang zum Netzteil nicht durch Möbel oder andere Gegenstände versperren.**

Das Netzteil erfüllt die Ökodesign-Anforderungen der Europäischen Union (Richtlinie 2005/32/EG). Dies bedeutet, dass sowohl im Betrieb als auch im Ruhezustand der Stromverbrauch im Vergleich zu Netzteilen älterer Bauart deutlich niedriger ist.



- Energiesparend
- Economisant l'énergie
- A risparmio di energia
- Energy efficient

## Hörgeräte kompatibel

Das Telefon ist auf Hörgeräte abgestimmt und mit den meisten am Markt befindlichen Hörgeräten kompatibel.

Durch die Vielzahl der angebotenen Modelle kann jedoch keine einwandfreie Funktion mit jedem Hörgerät garantiert werden.

**Achtung: Dieses Telefon kann sehr hohe Lautstärken wiedergeben, wenn der Verstärker aktiviert ist und der Lautstärkereglер auf Maximum steht. Große Vorsicht ist geboten beim Wechsel zwischen Benutzern mit normalem Gehör und vermindertem Gehör.**

## Entsorgung

Sie sind gesetzlich zur sachgerechten Entsorgung von Gebrauchsgütern verpflichtet. Das nebenstehende Symbol auf Ihrem Telefon bedeutet, dass elektrische und elektronische Altgeräte und Batterien getrennt vom Hausmüll zu entsorgen sind.



Elektrische oder elektronische Geräte entsorgen Sie bei einer Sammelstelle eines geeigneten Entsorgungsträgers.

Batterien entsorgen Sie beim batterievertreibenden Handel sowie bei zuständigen Sammelstellen, die entsprechende Behälter bereitstellen.

Verpackungsmaterialien entsorgen Sie entsprechend den lokalen Vorschriften.





## Fehlersuche und -behebung

### Service-Hotline

Haben Sie Probleme mit Ihrem Telefon, kontrollieren Sie zuerst die folgenden Hinweise.

Bei technischen Problemen können Sie sich an unsere Service-Hotline wenden.

Die Rufnummer finden Sie auf unserer Website [www.amplicomms.com](http://www.amplicomms.com)

Bei Garantieansprüchen wenden Sie sich an Ihren Fachhändler.

Die Garantiezeit beträgt 2 Jahre.

### Kein Telefongespräch möglich

- Die Telefonleitung ist nicht korrekt angeschlossen oder gestört. Verwenden Sie nur das mitgelieferte Telefonanschlusskabel.

### Einige Funktionen, z. B. +40 dB Verstärkung oder Freisprechen funktionieren nicht

- Kontrollieren Sie die Funktion des Netzteils.
- Kontrollieren Sie, ob die Batterien richtig eingesetzt sind, der Batterietyp stimmt und sie nicht entladen sind.

### Die Rufnummernanzeige funktioniert nicht

- Die Rufnummernanzeige ist ein Zusatzdienst Ihres Netzbetreibers. Bitte fragen Sie Ihren Netzbetreiber nach weiteren Informationen.
- Der Anrufer hat das Übertragen seiner Rufnummer unterdrückt.

## Pflegehinweise

- Reinigen Sie die Gehäuseoberflächen mit einem weichen und fusselreien Tuch.
- Verwenden Sie keine Reinigungsmittel oder Lösungsmittel.

## Garantie

AMPLICOMMS - Geräte werden nach den modernsten Produktionsverfahren hergestellt und geprüft. Ausgesuchte Materialien und hoch entwickelte Technologien sorgen für einwandfreie Funktion und lange Lebensdauer.

Ein Garantiefall liegt nicht vor, wenn die Ursache einer Fehlfunktion des Geräts bei dem Telefonnetzbetreiber oder einer eventuell zwischengeschalteten Nebenstellenanlage liegt. Die Garantie gilt nicht für die in den Produkten verwendeten Batterien, Akkus oder Akkupacks. Die Garantiezeit beträgt 24 Monate, gerechnet vom Tage des Kaufs.

Innerhalb der Garantiezeit werden alle Mängel, die auf Material- oder Herstellungsfehler zurückzuführen sind, kostenlos beseitigt. Der Garantieanspruch erlischt bei Eingriffen durch den Käufer oder durch Dritte. Schäden, die durch unsachgemäße Behandlung oder Bedienung, natürliche Abnutzung, durch falsches Aufstellen oder Aufbewahren, durch unsachgemäßen Anschluss oder Installation sowie durch höhere Gewalt oder sonstige äußere Einflüsse entstehen, fallen nicht unter die Garantieleistung.

Wir behalten uns vor, bei Reklamationen die defekten Teile auszubessern, zu ersetzen oder das Gerät auszutauschen. Ausgetauschte Teile oder ausgetauschte Geräte gehen in unser Eigentum über. Schadenersatzansprüche sind ausgeschlossen, soweit sie nicht auf Vorsatz oder grober Fahrlässigkeit des Herstellers beruhen.

Sollte Ihr Gerät dennoch einen Defekt innerhalb der Garantiezeit aufweisen, wenden Sie sich bitte unter Vorlage Ihrer Kaufquittung ausschließlich an das Geschäft, in dem Sie Ihr AMPLICOMMS - Gerät gekauft haben. Alle Gewährleistungsansprüche nach diesen Bestimmungen sind ausschließlich gegenüber Ihrem Fachhändler geltend zu machen. Nach Ablauf von zwei Jahren nach Kauf und Übergabe unserer Produkte können Gewährleistungsrechte nicht mehr geltend gemacht werden.

## Konformitätserklärung

Dieses Gerät erfüllt die Anforderungen der EU-Richtlinien:



EMC 2014/30/EU und LVD 2014/35/EU. Die Konformität mit den o. a. Richtlinien wird durch das CE-Zeichen auf dem Gerät bestätigt.

Für die komplette Konformitätserklärung nutzen Sie bitte den kostenlosen Download von unserer Website [www.amplicomms.com](http://www.amplicomms.com).





**Telephone**

- 1 Call back button
- 2 One-touch dialling button M1 (emergency call number 1)
- 3 Delete
- 4 One-touch dialling button M2 (emergency call number 2)
- 5 Scroll upwards
- 6 One-touch dialling button M3 (emergency call number 3)
- 7 Scroll downwards
- 8 LED, emergency call unit / New call indication (see page 64)
- 9 Menu button
- 10 Calls list (CLIP) / Phone book
- 11 R button
- 12 Microphone muting button
- 13 Redial button
- 14 LED, handsfree mode
- 15 Handsfree mode button
- 16 LED, telephone is ringing
- 17 Receiver +40 dB boost button

- 18 Volume boost on LED
- 19 Control knob, receiver volume (hidden under premium handset)
- 20 "Ringing volume" slide control
- 21 "Tone" slide control
- 22 "Handsfree volume" slide control

**Emergency call unit**

- 1 Start automatic emergency call
- 2 LED, battery level indicator

<b>Getting started</b> .....	<b>46</b>
Check box contents .....	46
Connecting the telephone.....	47
Wall mounting.....	49
Display icons .....	50
Setting date an time .....	52
Setting the language .....	52
 <b>Making and receiving calls</b> .....	 <b>53</b>
Dialling a telephone number .....	53
Ending a call.....	53
Taking a call.....	54
Activating/deactivating handsfree mode.....	54
Boost the handset earpiece volume .....	55
Setting the handset receiver volume.....	55
Ringer volume.....	55
Setting the handset receiver tone .....	55
Setting the handsfree volume .....	56

Muting the microphone .....	56
Dialling a telephone number using the redial function .....	56
Calling back missed calls .....	56
Dialling a telephone number from the phone book.....	57
One-touch dialling / Emergency call .....	58
Chain dialling .....	59
<b>Phone settings .....</b>	<b>60</b>
Phone book .....	60
Calls list.....	64
Emergency Call Unit.....	67
Settings.....	73
Special use .....	75

**Appendix.....76**

Safety notes .....76

Intended use.....76

Installation location .....76

Power supply .....77

Hearing aid compatibility.....77

Disposal .....78

Help and support / Troubleshooting guide .....79

Maintenance.....80

Guarantee .....80

Declaration of conformity .....81



# Getting started

**Important: please make sure you've read the safety information on page 76 before you set up your phone system.**

**Important: Your phone can produce very high sound when Boost is switched on. Please take care if the handset is used by others.**

## Check box contents

You should have:

- 1 corded phone base
- 1 power adapter plug
- 1 handset
- 1 coiled cord for handset
- 1 Emergency call unit, can be worn on neckband or wristband (splash-proof)
- 1 telephone line connector cable
- 4 Batteries, AA 1.5 V
- 1 Battery type 23A, 12 V already installed in the emergency call unit
- 1 wall-mounting bracket
- 1 user guide

**Important:**

- Use only the power adapter supplied with your telephone.
- Use only the telephone cable supplied with your telephone otherwise your phone may not work.

## Connecting the telephone

For using **all features** e. g. **Hands-Free** and **Amplification** it is **essential** that the telephone is **powered by the power supply and the batteries**.

1. Insert the batteries in the open battery compartment.

Only use batteries of the type AA 1.5 V.

Pay attention to the correct polarity.

Close the battery compartment cover.

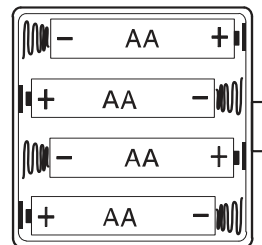

Pay attention that the telephone is not connected to the telephone line socket and/or mains power connection when the batteries are being inserted or replaced.

2. Connect the telephone as illustrated in the diagram. Only use the telephone cable supplied because the equipment may not function if another telephone cable is used.

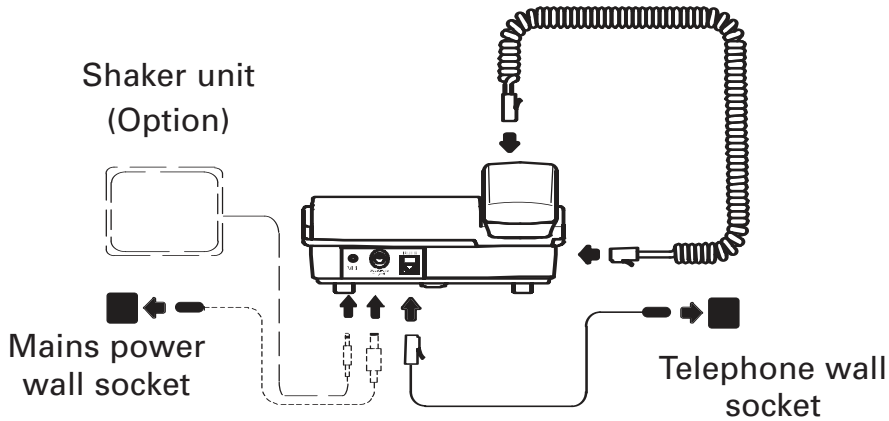

**In order to use an approved shaker unit, connect the shaker unit plug to the "Vibrat." socket in the telephone. No other work is necessary. The shaker unit is ready to operate immediately after connection. The shaker unit does not belong to the material supplied.**

## Wall mounting

The telephone can also be installed on a wall. You require two screws in order to fix the telephone on a wall.

Feed the guide tabs (1) on the wall-mounting bracket (2) in the slots (3) on the rear side of the telephone. Slide the wall bracket (2) 10 mm upwards until it audibly snaps into place.

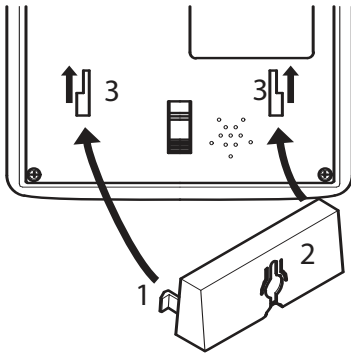

**Warning: Ensure that there are no cables or pipes etc. under the surface of the wall where you want to drill the holes.**

Drill two holes whose distance apart corresponds to the bracket to be used, insert the screws and allow them to project 5 mm from the wall. Position the telephone on the bracket, fit the screws in the slots and slide the telephone downwards a little.

Turn the receiver hook (4) in the receiver cradle 180° so that the receiver can be hooked in.

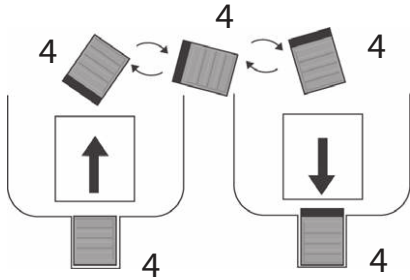

## Display icons



Replace the batteries.

14:45

Display of the time.

11/06

















Display of the date.











The phone book is open.

<b>CLIP</b>	The calls list is open.
<b>NEW</b>	The entry in the calls list is new.
<b>REPEAT</b>	Indicates a repeat call.
<small>CALLS</small> <b>01</b>	Position number in the call list.
<b>TOTAL: XX</b>	There are XX entries in the call list.
<b>NEW: XX</b>	There are XX new entries in the call list.
<b>VOICE</b>	Flashing: Recording mode is active (see pages 62, 68). On: A name has been recorded for this phone book entry.
<b>+</b>	An emergency call number (M1, M2 or M3) has been dialled (see page 69).

## Setting date and time

- Press .
- Select TIME/DATE using  /  and press .
- Adjust the hours using  /  and press .
- Adjust the minutes using  /  and press .
- Adjust the month using  /  and press .
- Adjust the day using  /  and press .
- Press  to exit the menu.

## Setting the language

- Press .
- Select LANGUAGE using  /  and press .
- Select a language using  /  and press .
- Press  to exit the menu.

**For more settings please refer to the chapter "Settings" on page 73**



# Making and receiving calls

## Dialling a telephone number

To start a call you have the following options:

- lift the handset and enter the phone number.
- enter the phone number and lift the handset.

or alternatively

- enter the phone number and press  or .

Handsfree mode will be activated and the phone number will be dialled (for handsfree mode power supply/batteries necessary).

- During a call you can see the call time on the display.

## Ending a call

For ending a call you can:

- replace the handset.

or alternatively

- press  if the call was made in handsfree mode (the red LED within the handsfree button is on).



## Taking a call

Lift the handset or press .

## Activating/deactivating handsfree mode

During a call you are making using the handset you can switch to handsfree mode to switch on the loudspeaker (power supply/batteries necessary).



Press  and then replace the handset.

If you want to continue the call using the handset simply lift the handset.

### **Please note:**

- **During handsfree mode your speech is transmitted via the microphone on the base. Speak at a distance of not more than 0.5 meters facing the front of the unit.**
- **High background noise levels can prevent satisfactory operation.**

## Boost the handset earpiece volume

You can boost the handset earpiece volume to +40 dB (power supply/batteries necessary). Press . The "On" LED   is on.

**Caution: This telephone is capable of producing very high volume levels when the amplifier is switched on and the volume control is set to maximum. Extreme caution should be taken if the handset is to be shared between users with normal hearing and those with hearing impairment.**

## Setting the handset receiver volume

You can adjust the handset receiver volume using the control (19) / (refer to inlay page).

## Ringer volume

You can adjust the ringer volume using the control (20) (refer to inlay page).

## Setting the handset receiver tone

You can adjust the handset receiver tone using the control (21) if the Boost function (60 dB) is on (refer to inlay page).

## Setting the handsfree volume

You can adjust the handsfree volume using the control (22) (refer to inlay page).

## Muting the microphone

The microphone in the handset can be activated and deactivated during a telephone conversation.

Press and hold  : Switch the microphone off (muting)

Release  : Switch the microphone on





## Dialling a telephone number using the redial function

Your telephone stores the last phone number dialled.



- Lift the handset or press  and then press .

## Calling back missed calls

The telephone stores the numbers of missed calls in a calls list. For further information please refer to the chapter „Calls list“ on page 64.





- Lift the handset or press , then select the desired entry using  and  and press  .

or alternatively





- select the desired entry using  and  and press  . The loudspeaker will be switched on. If you want to proceed the call using the handset, just lift it up. The loudspeaker will be switched off.

## Dialling a telephone number from the phone book

For how to create and store phonebook entries please refer to the chapter “Phone book” on page 60.

- Lift the handset or press  .
- Press  , select the desired entry using  and  and press  .

or





- Press , select the desired entry using  and  and press . The loudspeaker will be switched on. If you want to proceed the call using the handset, just lift it up. The loudspeaker will be switched off.

## One-touch dialling / Emergency call

The one-touch dialling / emergency call buttons M1, M2 or M3 can be used for normal quick dial numbers or as a memory location for automatic emergency call dialling. For how to store one-touch / emergency numbers please refer to the chapter “Storing emergency call / quick dial numbers” on page 69.

- Lift the handset or press .
- Press briefly the one-touch memory button ,  or .





or

- Press briefly the one-touch memory button ,  or .
- Lift the handset or press .

**Note: The telephone numbers assigned to the one-touch dialling buttons can not be deleted. When storing new numbers, the existing entries are overwritten.**

## Chain dialling

The function is used in more complex telephone services, e.g. for telephone banking, call-by-call or calling card procedures. Several numbers stored in the phone book can be dialled successively when a connection has already been made. It is also possible to combine numbers for transfer from the phone book with numbers entered manually. Numbers stored in the phone book can be chained and transmitted as required.

- Whilst in a call press  , select the desired entry using  /   
and press .

# Phone settings

## Phone book

30 phone numbers can be stored in the phone book together with the associated names.

- Always enter the area access code with the phone numbers so that the telephone can also assign incoming local calls to a phone book entry.
- When the memory capacity of the phone book is used up, the message **MEMORY FULL** appears when an attempt is made to store another number. To create space, an existing entry must first be deleted.
- The phone book entries are arranged alphabetically. To skip to the required phone book entry directly, enter the first letter of the corresponding entry.

### Entering a name









The digit keys are also labelled with letters for the entry of the respective letters. Pressing the respective key the necessary number of times enables capital letters and digits to be entered.

Enter a space by pressing  .

Delete a character by pressing  .



To enter the same letter twice, press the button to enter the letter. Wait until the cursor skips one place forward. Enter the letter again.

## Creating phone book entries





- Press .
- Select **STORE NUMBER** using  and  and press .
- Enter the telephone number and press .
- Enter the name and press .
- If you want to store a spoken name (which is spoken, when you call up the phonebook entry or a call from this person arrives) for the entry immediately, press and hold down .
- Speak the name for the entry and release  again, if you have finished.

**Note: You can also add a spoken name to a telephonebook entry later (see below).**

## Editing entries in the phone book









- Press  and select an entry using  and .



- Press and hold  for approx. 3 s and confirm **EDIT?** by pressing .
- Enter the new telephone number if necessary and confirm with .
- Enter the new name if necessary and confirm with .

### Record names to phonebook entries

A name can be recorded for each phone number stored in the phone book. When you subsequently select an entry in the phone book, the recording you made for it is played and you can hear the entry you have selected.

- Press .
- Select **NAME RECORDING** using  and  and press .
- Then select an entry using  and .
- Press and hold  to start recording and release  for ending.







**Note: If the key is not released, recording is automatically stopped after 3 seconds.**

- Press  to exit the menu.



## Deleting recordings

- Press .
- Select NAME RECORDING using  and  and press .
- Then select an entry using  and .
- Press  during playback to delete the recording.

## Deleting a single entry from the phone book

- Press  and select an entry using  and .
- Press . The display shows DELETE?.
- Press and hold  for approx. 4 s. Entry is deleted.
- To abort the deleting procedure press .

## Delete all entries from the phone book

- Press  and select an entry using  and .

- Press and hold  for approx. 4 s.  
The display shows **DELETE ALL?**.
- Press and hold  for approx. 4 s. again.
- To abort the deleting procedure press  .

## Calls list

**Note: The caller number display function, essential for the calls list, is a supplementary service offered by telephone network providers. Contact your network provider for further information.**





If this function is available with your telephone line, the number of the caller and the name, if an entry in the telephone book exists, appears in the display or is spoken when the phone rings. If the caller has suppressed transmission of his phone number or it is otherwise unavailable, a corresponding message appears in the display. The phone number is not displayed and, as a result, is not stored in the calls list.

The idle display shows, how many entries are in the calls list and how many of them are NEW (not yet seen). A total of 64 call numbers can be stored in the calls list. The flashing red LED indicates new calls in the calls list. **This LED will flash as long as there are still new (not read) calls in the calls list.** To stop flashing press  repeatedly.

### Displaying phone numbers in the calls list





- Select an entry using  and .

### Storing numbers from the calls list in the phone book





- Select an entry using  and .
- Press and hold  for approx. 3 seconds and confirm COPY TO MEMORY with .
- The phone number is stored in the phone book without a name being assigned. Then enter a name for the phone number (see “Editing entries in the phonebook”).

**Note: When the number in the phone book is stored together with a name, the name entered also appears in the calls list.**

## Deleting phone numbers individually

- Select an entry using  and .
- Press . The display shows **DELETE?**.
- Press and hold  for approx. 4 s. The entry is deleted.

## Deleting all entries

- Select an entry using  and .
- Press and hold  for approx. 4 s.  
The display shows **DELETE ALL?**.
- Press and hold  for approx. 4 s. again.

**Note: Before deleting the phone numbers, check that the entries have been viewed.**

## Emergency Call Unit

The emergency call unit can be used to dial an emergency services exchange or persons for assistance.







**Note: There are several appropriate emergency service call numbers available, such as the Red Cross, St. John's Ambulance Brigade, etc. In some countries emergency calls are not free of charge. The unit can also be used for private emergency calls within the family, for example.**

### Outgoing alert message

There is a default outgoing alert message recorded on the telephone. You can replace this message with one of your own. After activating an automatic emergency call, the phone numbers assigned to buttons **M1**, **M2** and **M3** are called automatically. The alert message is played repeatedly until your emergency call is acknowledged by the person receiving it through pressing the “0” key. For this reason, you must end your own alert message clearly telling the receiving party to “...take this emergency call by pressing the 0 key!”.

**Note: When recording your message, make sure that the person called recognises your name in the emergency call. Inform them clearly that this is an emergency call and that you need help.**

## Recording an outgoing alert message

- Press .
- Select RECORD MESSAGE using  /  and press .
- Press and hold down  when you speak your message.
- Release  to end recording.

## Playing the outgoing alert message









- Press .
- Select CHECK MESSAGE using  /  and press .

## Deleting the outgoing alert message

- Press .
- Select CHECK MESSAGE using  /  and press .
- Press  during playback. The message will be deleted.

## Storing emergency call / quick dial numbers

The quick dial buttons M1, M2 and M3 can be used for normal quick dial numbers or as memory locations for automatic emergency call dialling.

- Press .
- Select **STORE NUMBER** using  /  and press .
- Enter the telephone number (max. 22 digits) and press .
- Select a quick dial button ,  or  and press .

**Note: The phone numbers assigned to the quick dial keys cannot be deleted. When storing new numbers, the existing entries are overwritten.**

## Automatic emergency call

The automatic emergency call can be initiated by pressing and hold the buttons **M1**, **M2** or **M3** on the telephone or the button on the emergency call unit. If no phone number has been assigned to **M1**, **M2** or **M3**, no phone number is dialled but a loud warning signal is issued from the telephone.



**Note: Pay attention that the emergency call unit is within range of the telephone.  
The batteries in the emergency call unit should always be full.**

### Automatic emergency calls via the telephone

- Press and hold down **M1** , **M2** or **M3** for approx. 5 seconds to start the automatic emergency call function.
- Press **⏪** or again **M1** , **M2** or **M3** for approx. 5 seconds to end the automatic emergency call function.

### Automatic emergency calls via the emergency call unit

1. Press and hold the button (1) on the emergency call unit for 5 seconds to start the automatic emergency call function.
2. Halten Sie erneut die Taste am Notrufgeber für 5 Sekunden gedrückt, um den automatischen Notruf zu beenden.

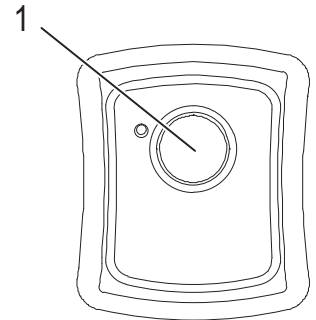

## Starting/Ending the automatic emergency call

The phone behaves as follows on starting the automatic emergency call:

1. The emergency phone loudspeaker is switched on. An acoustic “emergency call active” signal is sounded for 15 sec.
2. You can then hear the dialling tone and the phone numbers assigned to the **M1**, **M2** and **M3** buttons are automatically dialled, in succession, at intervals of approx. 60 seconds. The outgoing alert message is played in a continuous cycle.
3. The person answering the call immediately hears this alert message. The person taking the call stops the outgoing alert message by pressing “0”. You can then converse for 3 minutes. Handsfree mode remains active on the phone making the emergency call during this time.
4. When the 3 minutes have elapsed, the call is disconnected. An attempt begins again to dial the phone numbers assigned to buttons **M1**, **M2** and **M3** as described above.
5. If the call is disconnected or the receiver is placed on-hook before the 3 minutes have elapsed, an attempt is made to dial the emergency numbers. The emergency procedure won't be stop unless 3 numbers have been dialled out or press the button on the emergency call unit again or press **M1**, **M2** or **M3** for 5 seconds.

**Note: To end an emergency call, press the button on the emergency call unit again or press M1, M2 or M3 for 5 seconds.**

### Testing the emergency call unit battery

1. Press and hold the button (1) on the emergency call unit briefly. The LED (2) lights up.
2. If the LED (2) no longer lights up when the button is pressed and held, replace the battery.

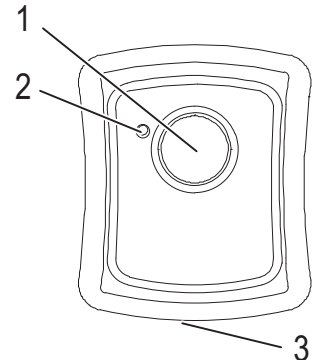



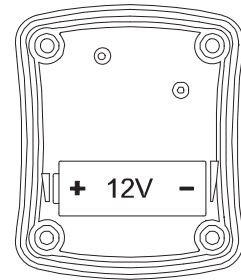

### Replacing the battery



1. Remove the screw on the rear side of the emergency call unit using a small, crosstip screwdriver.
2. Insert the tip of a small screwdriver in the notch (3) and open the housing.
3. Replace the battery. Only use batteries of the same type. Pay attention to correct polarity.
4. Close the housing.



## Settings

You can perform various settings on your phone.

- Press  to open the menu.
- Scroll using  and  to the desired entry and press  to open the relevant sub-menu.

LCD CONTRAST (1-5)      Modify settings using  and  or press  to keep the current setting.

TIME/DATE                      see page 52.

STORE NUMBER                see page 61, 69.

NAME RECORDING              see page 62.

RECORD MESSAGE              see page 68.

CHECK MESSAGE                see page 68.

## LANGUAGE

see page 52. The outgoing messages and display texts on the telephone are available in 4 languages.

## FLASH

In most situations the flash time of 100 ms should be selected. In some cases, e. g. when connecting the phone to a PABX, it may be necessary to switch to 300 ms. For further information please refer to the user guide of the PABX.

## RINGER TONE (1-3)

Modify settings using  and  or press  to keep the current setting.

## VOICE

When a button is pressed, a voice accompanies the action. This voice can be activated and deactivated, as required.

- Press  to exit the menu.

## Special use

### Use on a private branch exchange

If your phone's on an exchange (e.g. you need to dial 9 to get an outside line), you can transfer calls and use call back by using the  button.

You'll need to check your private exchange manual to find out which timing to use for your exchange.

### Insert a dialling pause

If you have to dial a number for an outside line and it takes a while to connect, you can insert a pause so you don't have to wait to hear the dialling tone.

To insert a dialling pause, simply enter the number you usually dial for an outside line and then press .

### Using additional services

Your phone should be able to support services such as call waiting and conference calls. You'll need to check with your telephone network provider for further information on these services.

# Appendix

## Safety notes

Please make sure you read this user guide carefully and keep it for further use.

## Intended use

The telephone is suitable for telephoning within a analogue public telephone network system. Any other use is considered unintended use. Unauthorised modification or reconstruction is not permitted. Under no circumstances open the device or attempt any repair work yourself.

## Installation location

Make sure your phone:

- is on a dry, flat and stable surface or mounted to a wall.
- isn't a trip hazard with its cables.
- isn't exposed to smoke, dust, vibration, chemicals, moisture, heat and direct sunlight.
- is at least one metre from other electrical appliances to avoid mutual interference.

Make sure that the access to the power adapter plug is not obstructed by furniture or such.

## Power supply

**Caution: Only use the power adapter plug supplied because other power supplies could damage the telephone. Ensure access to the power adapter plug is not obstructed by furniture or such.**

The included mains adapter meets the eco-design requirements of the European Union (Directive 2005/32/EG). Thus, its power consumption is considerably lower, both in operated as well as in non-operated mode, compared with the mains adapter of previous design.



- Energiesparend
- Economisant l'énergie
- A risparmio di energia
- Energy efficient

## Hearing aid compatibility

Your phone works with most popular hearing aids. However, given the wide range of hearing aids available, we can't guarantee that your phone will function fully with every hearing aid.

**Important: Your phone can produce very high sound when Boost is switched on. Please take care if the handset is used by others.**



## Disposal

You are obliged to dispose of consumable goods properly in accordance with the applicable legal regulations.

The symbol on this product indicates that electrical and electronic apparatus and batteries must be disposed of **separately** from domestic waste at suitable collection points provided by the public waste authorities. Batteries can also often be disposed of at the point of sale.



Packaging materials must be disposed of according to local regulations.



## Help and support / Troubleshooting guide

### Helpline

If you need some help and you're in the UK, please first check and see if your problem can be solved using the troubleshooting guide below. If it can't, please call us on 0844 800 6503 (using a UK landline, at the time of going to print: calls cost 6p for connection charge and then 5p a minute. Mobile costs may vary). Lines are open Monday to Friday, 9am to 5pm, excluding public holidays. If you've a claim on your 2-year guarantee, please contact your supplier.

### I can't make phone calls

- Make sure the phone cable is connected properly. If it is, there may be a fault. Please make sure you're using the phone cable that came with your phone.

### Some features e. g. the boost function and handsfree are not working

- Check the power supply.
- Make sure the batteries are inserted correctly, they are of the correct type and they are not exhausted.

### The display of incoming call numbers is not working

- Check you have this service on your phone line. Please call your network provider.
- The caller may have withheld their phone number.

**Helpline UK 0844 800 6503**

(See above for costs and hours of operation)

## Maintenance

- Please clean your equipment's surfaces with a soft, fluff-free cloth.
- Never use cleaning agents or solvents.

## Guarantee

AMPLICOMMS equipment is produced and tested according to the latest production methods. The implementation of carefully chosen materials and highly developed technologies ensure trouble free functioning and a long service life. The terms of the guarantee do not apply where the cause of the equipment malfunction is the fault of the telephone network operator or any interposed private branch extension system. The terms of the guarantee do not apply to the rechargeable batteries or power packs used in the products. The period of guarantee is 24 months from the date of purchase.

All deficiencies resulting from material of production faults which occur during the period of guarantee will be eliminated free of charge. Rights to claims under the terms of guarantee are annulled following intervention by the purchaser or third parties. Damage caused as a result of improper handling or operation, incorrect positioning or storing, improper connection or installation, Acts of God or other external influence are not covered by the terms of guarantee.

In the case of complaints, we reserve the right to repair or replace defect parts or provide a replacement device. Replacement parts or devices become our property.

Rights to compensation in the case of damage are excluded where there is no evidence or intent or gross negligence by the manufacturer.

If your equipment shows signs of defect during the period of guarantee, please return to the sales outlet in which you purchased the AMPLICOMMS equipment together with the purchase receipt. All rights to claims under the terms of guarantee in accordance with this agreement must be asserted exclusively with regard to your sales outlet.

Two years after the purchase of our products, claims under the terms of guarantee can no longer be asserted.

## Declaration of conformity

This device fulfils the requirements stipulated in the EU directives:



EMC 2014/30/EU and LVD 2014/35/EU.

Conformity with the above mentioned directives is confirmed by the CE symbol on the device.

To view the complete Declaration of Conformity, please refer to the free download available on our website [www.amplicomms.com](http://www.amplicomms.com)

## **Téléphone**

- 1 Touche d'appel
- 2 Touche de sélection directe M1 (numéro appel d'urgence 1)
- 3 Effacer
- 4 Touche de sélection directe M2 (numéro appel d'urgence 2)
- 5 Faire défiler vers le haut
- 6 Touche de sélection directe M3 (numéro appel d'urgence 3)
- 7 Faire défiler vers le bas
- 8 LED transmetteur d'appel de secours/Affichage des nouveaux appels (page 104)
- 9 Touche de menu
- 10 Liste d'appels (CLIP) / Répertoire
- 11 Touche R
- 12 Désactivation du microphone (secret)
- 13 Rappel du dernier numéro composé
- 14 LED mode « mains libres »
- 15 Touche mains libres

- 16 Affichage LED « Le téléphone sonne »
- 17 Augmenter le volume sonore du combiné
- 18 LED mode « volume sonore augmenté »
- 19 Réglage du volume sonore (caché sous le combiné)
- 20 Réglage du volume de la sonnerie
- 21 Réglage du son
- 22 Réglage du volume sonore en mode mains libres

## **Transmetteur d'appel d'urgence**

- 1 Lancer l'appel d'urgence automatique
- 2 LED de niveau des piles

<b>Mise en service du téléphone .....</b>	<b>86</b>
Vérification du contenu du coffret .....	86
Raccordement du téléphone.....	87
Montage mural .....	89
Affichage sur l'écran.....	90
Régler la date/l'heure .....	92
Régler la langue.....	92
 <b>Téléphoner .....</b>	 <b>93</b>
Composer et choisir un numéro manuellement.....	93
Terminer l'appel .....	93
Recevoir un appel.....	94
Activer/Désactiver l'écoute amplifiée .....	94
Activer l'amplification du volume sonore du combiné.....	95
Régler le volume sonore du combiné .....	95
Volume de la sonnerie.....	95
Régler le son du combiné .....	95
Régler le mode mains libres.....	96

Désactiver le microphone .....	96
Composer un numéro à l'aide de la répétition de la numérotation .....	96
Composer un numéro à partir de la liste d'appels.....	96
Composer un numéro à partir du répertoire .....	97
Composer un numéro direct .....	98
Enchaînement et transmission de numéros .....	99
<b>Régler le téléphone.....</b>	<b>100</b>
Répertoire .....	100
Transmetteur d'appel d'urgence .....	107
Réglages .....	114
Fonctions spéciales .....	116

<b>Annexe.....</b>	<b>117</b>
Consignes de sécurité .....	117
Utilisation conforme aux prescriptions .....	117
Lieu d’installation .....	117
Bloc secteur.....	118
Compatibilité avec des appareils auditifs.....	118
Élimination .....	119
Recherche et correction d’erreurs.....	120
Remarques d’entretien.....	121
Garantie .....	121
Déclaration de conformité .....	122



# Mise en service du téléphone

**Important : veuillez lire les consignes de sécurité de la page 117 avant la mise en service du téléphone.**

**Attention : Ce téléphone peut restituer des volumes sonores très élevés lorsque l'amplificateur est activé et que le volume est réglé au maximum. Veuillez faire attention lors du passage d'un utilisateur entendant normalement à un utilisateur malentendant.**

## Vérification du contenu du coffret

Font partie des objets fournis:

- 1 Téléphone (appareil de base)
- 1 Bloc secteur
- 1 Combiné
- 1 Câble spiralé pour combiné
- 1 Transmetteur d'alarme, à porter soit autour du cou soit au bras (protégé contre les éclaboussures)
- 1 Câble de raccordement téléphonique
- 4 Piles AA 1,5 V
- 1 Pile de type 23 A, 12 V déjà installée dans le transmetteur d'appel d'urgence
- 1 Support pour montage mural
- 1 Mode d'emploi

**Important:**

- **Utilisez uniquement le chargeur livré avec le téléphone.**
- **Utilisez uniquement le câble de connexion fourni avec le téléphone, l'appareil pourrait éventuellement ne pas fonctionner avec un autre câble de connexion.**

## Raccordement du téléphone

Une **alimentation électrique est nécessaire** afin de pouvoir utiliser **toutes les fonctions** du téléphone telles que « **mains-libres** » et **amplification du volume du combiné**. Celle-ci peut être réalisée à l'aide du bloc d'alimentation livré et par des piles.

1. Insérez les piles dans le compartiment à piles ouvert. Utilisez uniquement des piles du type AA 1,5 V. Respectez la polarité des piles! Refermez le compartiment à piles.

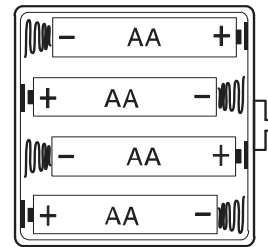

Veuillez toujours observer que votre téléphone ne soit pas relié au raccordement téléphonique et/ou au réseau lorsque vous introduisez ou changez les piles.

2. Raccordez le téléphone comme représenté sur l'illustration. Utilisez uniquement le câble de raccordement fourni, car l'appareil pourrait ne pas fonctionner avec un autre câble.

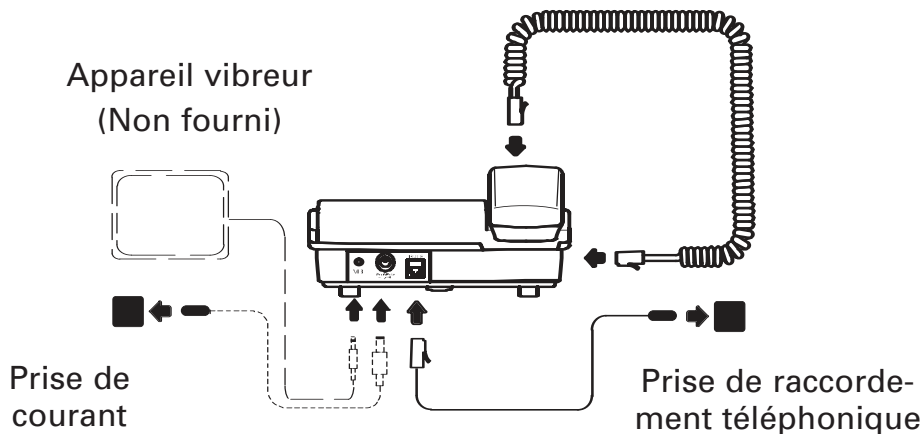

**Afin d'utiliser un appareil vibreur adapté, insérez la fiche d'alimentation de l'appareil vibreur dans la prise du téléphone. Aucune autre installation n'est nécessaire. L'appareil vibreur n'est pas fourni.**

## Montage mural

Votre téléphone est aussi conçu pour le montage mural. Vous avez besoin de deux vis pour fixer le téléphone.

Introduisez les tenons de guidage (1) de la fixation pour montage mural (2) dans les encoches (3) situées à l'arrière de votre téléphone. Poussez la fixation pour montage mural (2) de 10 mm vers le haut jusqu'à ce que vous entendiez son enclenchement.

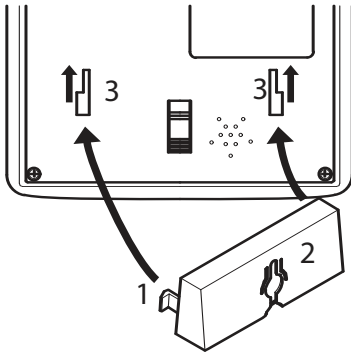

**Avvertissement: il ne doit pas y avoir de conduites (câbles, tuyaux etc.) dans la zone de perforation des trous.**

Perforez deux trous à une même distance l'un de l'autre que celle qui sépare les suspensions prévues et laissez sortir les vis du mur de 5 mm. Fixez maintenant le téléphone en posant les encoches sur les vis et poussez légèrement

vers le bas.

Tournez le loquet de verrouillage du combiné (4) de 180° afin de pouvoir accrocher ce dernier.

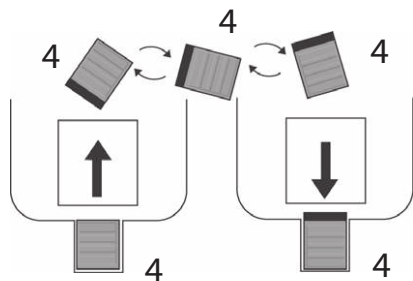

## Affichage sur l'écran



Changez les piles.

14:45

Affichage de l'heure.

11/06

Affichage de la date.



Vous vous trouvez dans le répertoire.

**CLIP**

Vous vous trouvez dans la liste d'appels.

**NEW**

Nouvelle entrée dans la liste d'appels.

**REPEAT**

Appel multiple de cette ligne téléphonique.

**CALLS**  
**01**

Affichage de la position du numéro dans la liste d'appels.

**TOTAL: XX**

Vous avez XX entrées dans votre liste d'appels.

**NUM: XX**

Vous avez XX nouvelles entrées dans votre liste d'appels.

**VOICE**

















Clignotant : Vous vous trouvez en mode enregistrement (page 102, 108).

Constant : Un nom a été mémorisé pour cet enregistrement du répertoire.

**+**

Un numéro appel d'urgence (M1, M2 ou M3) est composé (page 110).

## Régler la date/l'heure

- Appuyez sur .
- Sélectionnez à l'aide de  /  HEURE/DATE et appuyez sur .
- Entrez l'heure à l'aide de  /  et appuyez sur .
- Entrez les minutes à l'aide de  /  et appuyez sur .
- Entrez le mois à l'aide de  /  et appuyez sur .
- Entrez le jour à l'aide de  /  et appuyez sur .
- Quittez le menu avec .

## Régler la langue

- Appuyez sur .
- Sélectionnez à l'aide de  /  LANGUE et appuyez sur .
- Sélectionnez un langue à l'aide de  /  et appuyez sur .
- Quittez le menu avec .

**Vous trouverez d'autres réglages dans le chapitre « Réglages », v. p 114**

# Téléphoner

## Composer et choisir un numéro manuellement

Pour effectuer un appel, vous pouvez:

- d'abord décrocher le combiné et ensuite composer le numéro.
- composer le numéro et ensuite décrocher le combiné.

ou

- composer un numéro et appuyer ensuite sur  ou sur  .

Le haut-parleur est activé et le numéro est composé (pour le fonctionnement du haut-parleur, bloc d'alimentation/piles nécessaires).

- La durée de la communication s'affiche pendant l'appel.

## Terminer l'appel

Vous pouvez, pour terminer l'appel:

- raccrocher le combiné.

ou

- appuyer sur la touche  , si l'appel a eu lieu en utilisant le haut-parleur (la lumière rouge sous la touche s'allume).



## Recevoir un appel

Décrochez le combiné ou appuyez sur la touche .

## Activer/Désactiver l'écoute amplifiée

Pendant une communication téléphonique réalisée à l'aide du combiné, vous pouvez activer le haut-parleur (bloc d'alimentation/piles nécessaire).



Pour cela, appuyez sur la touche  et raccrochez le combiné.

Pour reprendre la communication avec le combiné, il suffit de décrocher le combiné.

### **Veillez noter :**

- Lorsque le haut-parleur fonctionne, votre voix est transmise du microphone vers l'appareil de base. Parlez en observant une distance de 50 cm par rapport à l'appareil de base.
- Les bruits dans votre environnement peuvent éventuellement être repris et peuvent nuire à la qualité de la conversation avec votre interlocuteur.

## Activer l'amplification du volume sonore du combiné

Le volume sonore du combiné peut être amplifié +40 dB (bloc d'alimentation/piles nécessaire). Pour cela, appuyez sur la touche . L'affichage « un »  est allumé.

**Avertissement : ce volume sonore peut causer des dommages chez des personnes entendant normalement!**

## Régler le volume sonore du combiné

Vous pouvez adapter le volume sonore du combiné en tournant un bouton (19), (voir page d'insertion).

## Volume de la sonnerie

Vous pouvez régler le volume de la sonnerie à l'aide d'un commutateur à glissière (20) (voir page d'insertion).

## Régler le son du combiné

Vous pouvez régler le son du combiné à l'aide d'un commutateur à glissière (21), lorsque l'amplification est activée à +40 dB (voir page d'insertion).

## Régler le mode mains libres

Vous pouvez régler le mode mains libres à l'aide d'un commutateur à glissière (22) (voir page d'insertion).

## Désactiver le microphone



Pendant une communication, vous pouvez activer et désactiver le microphone du combiné.

Maintenir  : désactiver le microphone

Relâcher  : le microphone est réactivé

## Composer un numéro à l'aide de la répétition de la numérotation





Le téléphone enregistre les numéros récemment composés.

- Décrochez le combiné d'abord ou appuyez sur la touche  et ensuite sur la touche .



## Composer un numéro à partir de la liste d'appels

Les appels que vous n'avez pas pris sont enregistrés dans la liste d'appels.

Vous trouverez de plus amples informations dans le chapitre « Liste d'appels » en page 104.



- Décrochez le combiné d'abord ou appuyez sur la touche , sélectionnez alors l'entrée souhaitée à l'aide des touches  et  et appuyez sur .

ou

- Sélectionnez d'abord l'entrée souhaitée à l'aide des touches  et  et décrochez alors le combiné ou appuyez sur . Le haut-parleur est activé. Si vous voulez poursuivre la conversation par le combiné, décrochez celui-ci. Le haut-parleur est alors désactivé.





## Composer un numéro à partir du répertoire

Vous trouverez des informations sur le réglage et l'enregistrement des entrées du répertoire dans la rubrique « Répertoire », en page 100.

- Décrochez le combiné d'abord ou appuyez sur la touche .
- Appuyez sur la touche , sélectionnez l'entrée souhaitée avec la touche





 et  et appuyez sur .

ou

- Appuyez d'abord sur la touche , sélectionnez l'entrée souhaitée avec la touche  et  et décrochez alors le combiné ou appuyez sur la touche . Le haut-parleur est activé. Si vous voulez poursuivre la conversation par le combiné, décrochez celui-ci. Le haut-parleur est alors désactivé.

## Composer un numéro direct

Vous pouvez utiliser les touches de sélection directe M1, M2 ou M3 comme sélection directe normale ou comme places de mémoire pour l'appel d'urgence automatique. Vous trouverez des renseignements sur les appels directs/appels d'urgence dans la rubrique « Enregistrer les numéros appel d'urgence/ les numéros à sélection directe » en page 109.

- Décrochez le combiné d'abord ou appuyez sur la touche .
- Appuyez sur les touches d'appel d'urgence ,  ou .





ou

- Appuyez d'abord sur les touches d'appel d'urgence **M1** , **M2** ou **M3** .
- Décrochez alors le combiné ou appuyez sur la touche  .

**Note : Vous ne pouvez pas effacer les numéros enregistrés sur les touches d'appel direct ou les numéros d'urgence. Lorsque vous enregistrez de nouveaux numéros, les anciens enregistrements sont écrasés.**

## Enchaînement et transmission de numéros

La fonction d'enchaînement de numéros est employée dans le cas de services de télécommunication plus complexes comme par ex. la banque par téléphone, l'appel par appel ou l'emploi de la carte pastel. Vous pouvez transmettre plusieurs numéros enregistrés dans le répertoire pendant une communication. Vous pouvez combiner des transmissions de numéros de votre répertoire avec des saisies manuelles de numéros. Pendant une communication, vous pouvez numéroter en chaîne autant d'enregistrements de votre répertoire que vous désirez et les transférer.

- Appuyez sur la touche  pendant une communication existante, sélectionnez l'entrée souhaitée à l'aide des touches  et  et appuyez sur  .

# Régler le téléphone

## Répertoire

Le répertoire peut enregistrer 30 numéros d'appel avec les noms correspondants.

- Saisissez toujours les numéros d'appel avec l'indicatif afin que le téléphone puisse aussi attribuer les communications locales à un enregistrement du répertoire.
- Si la capacité de mémoire est épuisée, l'écran affiche, lors de l'enregistrement suivant, le message **MEMOIRE PLEINE**.  
Vous devez d'abord effacer une entrée afin de faire de la place.
- Les entrées du répertoire sont classées par ordre alphabétique. Pour afficher l'entrée désirée, appuyez sur la touche correspondant à la première lettre du nom.

### Introduction de noms









Les touches numériques correspondent à des lettres. En appuyant plusieurs fois sur la touche appropriée, vous pouvez saisir des lettres, des chiffres et des caractères spéciaux.

Vous pouvez saisir des espaces à l'aide des touches  .

Vous pouvez effacer des signes  .

Pour taper deux fois la même lettre, appuyez d'abord une fois sur la lettre appropriée. Attendez que le curseur passe derrière la lettre (curseur clignotant). Puis tapez la lettre de nouveau.







### Régler les entrées du répertoire

- Appuyez sur .
- Sélectionnez SAUVER NUMERO avec la touche  et  et appuyez sur .
- Saisissez le numéro et appuyez sur .
- Saisissez le nom et appuyez sur .
- Si vous voulez saisir immédiatement un nom parlé (est annoncé en cas d'affichage dans le répertoire ou en cas d'appel des numéros concernés), appuyez sur  et maintenez la touche appuyée.
- Prononcez le nom pour cette entrée, puis relâchez la touche .

**A noter : vous pouvez également ajouter le nom parlé à une entrée du répertoire ultérieurement.**









## Modifier les entrées du répertoire

- Appuyez d'abord sur la touche , sélectionnez l'entrée souhaitée avec la touche  et .
- Appuyez sur  pendant env. 3 secondes et confirmez en sélectionnant **ADAPTER?** avec .
- Saisissez éventuellement le nouveau numéro et appuyez sur .
- Saisissez éventuellement le nouveau nom et appuyez sur .

## Ajouter le nom parlé

Vous pouvez enregistrer un nom pour chaque entrée du répertoire. Quand un appel de ce numéro d'appel vous parvient ou quand vous sélectionnez l'entrée concernée dans le répertoire, votre enregistrement est lu et vous entendez qui vous appelle ou quelle entrée vous avez sélectionnée.







- Appuyez sur .
- Sélectionnez **ENREGISTRER NOM** avec la touche  et  et appuyez sur .
- Sélectionnez l'entrée souhaitée avec la touche  et .

- Appuyez sur  et maintenez la touche appuyée pendant que vous prononcez le nom.

**Note : Si vous ne relâchez pas la touche, l'enregistrement se terminera automatiquement au bout de 3 secondes.**



- Pour quitter le menu, appuyez sur .

### Effacer le nom parlé







- Appuyez sur .
- Sélectionnez ENREGISTRER NOM avec la touche  et  et appuyez sur .
- Sélectionnez l'entrée souhaitée avec la touche  et .
- Appuyez sur  pendant la lecture.

### Effacer une entrée du répertoire

- Appuyez d'abord sur la touche , sélectionnez l'entrée souhaitée avec la touche  et .

- Appuyez sur . L'écran affiche EFFACER?
- Appuyez sur  pendant env. 4 secondes. L'entrée est effacée.
- Pour interrompre la suppression, appuyez sur .

### Effacer toutes les entrées du répertoire

- Appuyez d'abord sur la touche , sélectionnez l'entrée souhaitée avec la touche  et .
- Appuyez sur  pendant env. 4 secondes.  
L'écran affiche EFFACER TOUT?
- Appuyez de nouveau sur  pendant env. 4 secondes.
- Pour interrompre la suppression, appuyez sur .

### Liste d'appels

**Conseil : pour utiliser cette fonction, la transmission du numéro d'appel vers votre ligne doit être activée. Contactez votre opérateur réseau pour plus d'informations.**





Si l'affichage du numéro d'appel (CLIP) est disponible sur votre ligne téléphonique, le numéro de votre correspondant ou son nom, si le numéro correspond à une entrée du répertoire, s'affichent lorsque le téléphone sonne. Si votre correspondant a bloqué la transmission de son numéro, ou si pour toute autre raison le numéro n'est pas accessible, un message correspondant sera affiché. Le numéro d'appel ne peut pas être affiché et donc être enregistré dans la liste d'appels.

Vous distinguez sur l'écran de veille les appels qui sont sur la liste d'appels et les NOUVEAUX appels (pas encore vus). La liste d'appels peut enregistrer 64 numéros en tout. La LED clignotante indique que de nouveaux appels ont été enregistrés dans la liste d'appels. **Cette LED clignote tant que des entrées pas encore consultées existent. Pour arrêter le clignotement, appuyez sur la touche  de manière répétée.**

### Afficher un numéro de la liste d'appels

- Sélectionnez une entrée à l'aide des touches  et  .





### Enregistrer un numéro dans le répertoire à partir de la liste d'appels

- Sélectionnez une entrée à l'aide des touches  et  .
- Appuyez sur  pendant env. 3 secondes et confirmez **COPIER A MEMOIRE** avec  .





- Le numéro d'appel a été déposé sans nom dans le répertoire. Saisissez maintenant un nom pour le numéro (-> Modifier les entrées du répertoire).

**Note : Dès que le numéro a été enregistré dans le répertoire avec un nom, celui-ci apparaît également dans la liste d'appels.**

### Effacer une entrée

- Sélectionnez une entrée à l'aide des touches  et  .
- Appuyez sur  . L'écran affiche EFFACER?
- Appuyez sur  pendant env. 4 secondes. L'entrée est effacée.

### Effacer complètement la liste d'appels

- Sélectionnez une entrée à l'aide des touches  et  .
- Appuyez sur  pendant env. 4 secondes.  
L'écran affiche EFFACER TOUT?
- Appuyez de nouveau sur  pendant env. 4 secondes.

**Note : Contrôlez, avant d'effacer les numéros d'appel que les enregistrements ont bien été regardés.**

## Transmetteur d'appel d'urgence

Le transmetteur d'appel d'urgence vous permet d'appeler à l'aide des services d'alarme ou des personnes.



**Note : Il existe de nombreux services d'alarme tels que p. ex. la "Croix Rouge", les "Oeuvres de bienfaisance de la Croix de Malte" et les Chevaliers hospitaliers de Saint-Jean de Jérusalem". Dans bien des pays, les services d'alarme sont payants. Vous pouvez également utiliser cet appareil au sein de votre famille comme installation d'appel d'urgence.**

### Annonce d'appel d'urgence





Une annonce d'appel d'urgence prédéfinie se trouve déjà dans votre téléphone. Si vous démarrez un appel d'urgence automatique, les numéros d'appel enregistrés sur les touches M1, M2 und M3 seront appelés automatiquement. Votre annonce d'appel d'urgence sera reproduite jusqu'à ce que l'une de ces personnes ait pris votre appel avec la **touche « 0 »**. C'est pourquoi vous devez toujours terminer votre propre annonce d'appel d'urgence par la phrase « **Prenez cet appel d'urgence avec la touche 0!** ».

**Note : Dans votre annonce, veillez à ce que la personne appelée reconnaisse de qui provient cet appel. Dans votre annonce, attirez bien l'attention sur le fait qu'il s'agit d'un appel d'urgence et que vous avez besoin d'aide.**





## Enregistrer une annonce d'appel d'urgence

- Appuyez sur .
- Sélectionnez **ENREG. MESSAGE** avec la touche  et  et appuyez sur .
- Appuyez sur  et maintenez la touche appuyée pendant que vous dites l'annonce.
- Pour arrêter l'annonce, relâchez .

## Écouter l'annonce d'appel d'urgence









- Appuyez sur .
- Sélectionnez **CONTROLL. MESS** avec la touche  et  et appuyez sur .

## Effacer l'annonce d'appel d'urgence

- Appuyez sur .
- Sélectionnez **CONTROLL. MESS** avec la touche  et  et appuyez sur .
- Appuyez sur  pendant la lecture. L'annonce est supprimée.

## Enregistrer les numéros appel d'urgence/ les numéros à sélection directe

Vous pouvez utiliser les touches de sélection directe M1, M2 ou M3 comme sélection directe normale ou comme places de mémoire pour l'appel d'urgence automatique.

- Appuyez sur .
- Sélectionnez **SAUVER NUMERO** avec la touche  et  et appuyez sur .
- Entrer le numéro d'appel (max. 22 chiffres) et appuyez sur .
- Sélectionner la touche de sélection directe ,  ou  et appuyez sur .



**Note : Vous ne pouvez pas effacer les numéros enregistrés sur les touches de sélection directe. Lorsque vous enregistrerez de nouveaux numéros, les anciens enregistrements seront alors écrasés.**







### **Appel d'urgence automatique**

L'alarme automatique peut être activée en appuyant sur les touches **M1**, **M2** ou **M3** du téléphone ou sur le bouton d'alarme et en les maintenant enfoncés. Si vous n'avez pas enregistré de numéro sur l'une des touches **M1**, **M2** ou **M3**, aucun numéro ne sera composé, mais votre téléphone reproduira un signal d'avertissement.

**Note : Veillez à ce que le transmetteur d'appel d'urgence se trouve à portée de votre téléphone.**

**Une pile pleine doit toujours se trouver dans le transmetteur d'appel d'urgence.**

### **Appel d'urgence automatique via le téléphone**

- Appuyez sur  ,  ou  pendant env. 5 secondes pour démarrer l'appel d'urgence automatique.
- Appuyez sur  ou à nouveau  ,  ou  pendant env. 5 secondes pour démarrer l'appel d'urgence automatique.

### Appel d'urgence automatique via le transmetteur

1. Maintenez appuyée pendant 5 secondes la touche (1) du transmetteur d'appel d'urgence pour démarrer l'appel d'urgence automatique.
2. Maintenez de nouveau appuyée pendant 5 secondes la touche du transmetteur pour terminer l'appel d'urgence automatique.

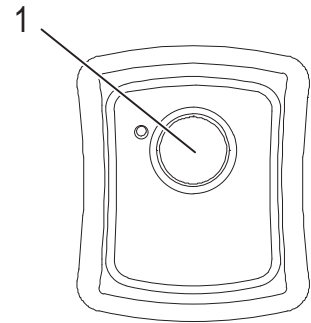

### Démarrer / terminer l'appel d'urgence automatique

Au démarrage de l'appel d'urgence automatique, votre téléphone se comporte comme suit :

1. Le haut-parleur du téléphone de secours se branche. Un signal « appel d'urgence actif » se fait entendre pendant 15 secondes.
2. Ensuite, vous entendez la tonalité et les numéros d'appel enregistrés sur les touches **M1**, **M2** et **M3** sont composés automatiquement les uns après les autres à intervalles d'env. 60 secondes. L'annonce d'appel d'urgence enregistrée est reproduite en boucle infinie.
3. Dès qu'une personne répond à l'appel, celle-ci entend cette annonce. En appuyant sur la **touche « 0 »**, la personne arrête l'annonce. Il est maintenant possible de téléphoner pendant 3 minutes. Pendant ce temps, le mode mains-libres du téléphone de secours reste activé.
4. Au bout des 3 minutes, la connexion s'interrompt. Comme décrit plus haut,

le téléphone essaie d'établir une liaison avec les numéros d'appel enregistrés sur les touches **M1, M2** et **M3**.

5. Lorsque la communication est coupée ou interrompue avant que les 3 minutes soient écoulées, une connexion avec les numéros enregistrés suivants est tentée, jusqu'à ce que les 3 numéros aient été composés. Pendant ce temps la ligne du téléphone reste occupée.

**Note : Pour terminer un appel d'urgence, maintenez de nouveau appuyée pendant 5 secondes la touche du transmetteur d'appel d'urgence ou les touches M1, M2, M3.**

### **Vérifier la pile du transmetteur d'appel d'urgence**

1. Maintenez brièvement appuyée la touche (1) du transmetteur d'appel d'urgence. La DEL (2) s'allume.
2. Si la DEL (2) ne s'allume plus pendant que la touche est appuyée, remplacez la pile.

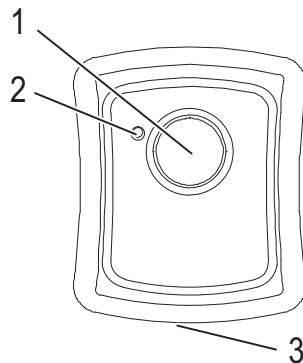



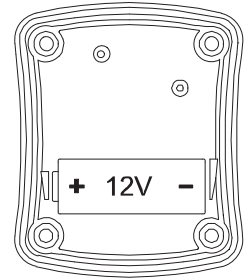

## Remplacer la pile



1. Retirez la vis située à l'arrière du transmetteur avec un petit tournevis cruciforme.
2. Ouvrez le boîtier à l'aide d'un petit tournevis à l'endroit de la rainure (3).
3. Remplacez la pile. N'utilisez que des piles de même type. Observez une polarisation correcte !
4. Fermez le boîtier.



## Réglages

Vous pouvez effectuer différents réglages sur votre téléphone.

- Appuyez sur . **Le menu s'ouvre.**
- Allez au point de menu souhaité à l'aide de  et  et appuyez sur  pour ouvrir le sous-menu respectif.

CONTRASTE LCD (1-5)    Modifiez les paramètres avec  et  ou appuyez sur , pour conserver les paramètres actuels.

HEURE/DATE                    -> page 92.

SAUVER NUMERO                -> page 101, 109.

ENREGISTRER NOM              -> page 102.

ENREG. MESSAGE               -> page 108.

CONTROLL. MESS.               -> page 108.

LANGUE                         -> page 92. Vous pouvez paramétrer les annonces





## FLASH

et les textes sur l'écran du téléphone en 4 langues.

Pour utiliser les fonctions du réseau analogique, le temps de flash correct est de 100 ms. Il peut être toutefois nécessaire, par exemple, lors de l'utilisation dans un réseau de télécommunications, de régler le temps de flash à 300 ms. Pour des informations plus précises, veuillez consulter le mode d'emploi de l'installation.

## MEL. SONNERIE (1-3)

Modifiez les paramètres avec  et  ou appuyez sur , pour conserver les paramètres actuels.

## PAROLE

La pression sur quelques touches est accompagnée d'une voix. Vous pouvez la désactiver et l'activer.

- Appuyez sur  pour quitter le menu.

## Fonctions spéciales

### Utilisation dans une installation téléphonique

Lorsque vous utilisez votre téléphone au sein d'une installation (lorsque, par exemple, vous devez composer le « 0 » pour accéder à une ligne extérieure) vous utilisez la touche  pour accéder aux fonctions de commutation que vous offre l'installation. Veuillez consulter la documentation pour définir la longueur du signal flash nécessaire pour votre installation.

### Introduire une pause de numérotation

Si vous souhaitez introduire une pause de numérotation dans un numéro de téléphone, appuyez sur la touche  en maintenant le curseur à l'endroit approprié.

### Utiliser des services fournis par l'opérateur

Vous pouvez utiliser des services supplémentaires fournis par votre opérateur comme « Appel entrant » ou « Conférence ». Veuillez vous renseigner précisément auprès de votre opérateur.

# Annexe

## Consignes de sécurité

Lisez très attentivement ce mode d'emploi et conservez-le soigneusement.

## Utilisation conforme aux prescriptions

Ce téléphone est conçu pour être utilisé à l'intérieur d'un réseau téléphonique. Toute autre utilisation n'est pas conforme à l'usage. Les modifications effectuées par l'utilisateur ne sont pas autorisées. En aucun cas vous ne devez ouvrir l'appareil ou tenter de le réparer vous-même.

## Lieu d'installation

Veillez noter:

- Posez votre téléphone sur une surface plate ou fixez-le au mur.
- Posez le câble de raccordement de manière à éviter de trébucher avec.
- Assurez-vous que le bloc et la prise sont toujours accessibles et qu'on peut rapidement débrancher le téléphone de la prise.
- Maintenez le téléphone à une distance d'environ 1 mètre d'autres appareils électriques, afin d'éviter des influences réciproques.
- Évitez les nuisances dues à la fumée, la poussière, les vibrations, les produits chimiques, l'humidité, la chaleur ou le rayonnement solaire direct.



## Bloc secteur

**Avertissement : veuillez utiliser uniquement le bloc d'alimentation fourni avec l'appareil, d'autres blocs d'alimentation pourraient endommager l'appareil. L'accès au bloc d'alimentation ne doit pas être entravé par des meubles ou d'autres objets.**

Le bloc secteur remplit les exigences en matière de design écologique de l'Union européenne (Directive 2005/32/CE).

Cela signifie que, aussi bien lorsque l'appareil fonctionne que lorsqu'il est éteint, la consommation électrique est moindre par rapport à d'autres modèles de blocs secteur.



- Energiesparend
- Economisant l'énergie
- A risparmio di energia
- Energy efficient

## Compatibilité avec des appareils auditifs

Ce téléphone est compatible avec la plupart des appareils auditifs présents sur le marché.

Étant donné le grand nombre de modèles proposés sur le marché, un fonctionnement sans défaut ne peut pas être garanti avec tous les appareils auditifs.

**Attention : Ce téléphone peut restituer des volumes sonores très élevés lorsque l'amplificateur est activé et que le volume est réglé au maximum. Veuillez faire attention lors du passage d'un utilisateur entendant normalement à un utilisateur malentendant.**

## Élimination

La loi vous oblige à éliminer de manière appropriée les biens de consommation. L'icône ci-contre sur votre téléphone signifie que les anciens appareils électriques et électroniques ainsi que les piles doivent être éliminés séparément des ordures ménagères. Éliminez les appareils électriques ou électroniques dans le centre de collecte d'un organisme approprié d'élimination des déchets.

Éliminez les piles auprès d'un revendeur spécialisé ainsi que dans des centres de collecte qui mettent à votre disposition les collecteurs appropriés.

Les matériaux d'emballage doivent être éliminés conformément aux règlements locaux.



## Recherche et correction d'erreurs

### Hotline de service

Si vous avez des problèmes avec votre téléphone, vérifiez d'abord les points suivants. En cas de problème technique, vous pouvez vous adresser à notre service d'assistance téléphonique. Le numéro de téléphone peut être trouvé sur notre site **[www.amplicomms.com](http://www.amplicomms.com)**

Si votre téléphone est toujours sous garantie, adressez-vous à votre revendeur. La durée de la garantie est de 2 ans.

### Aucune communication téléphonique n'est possible

- La ligne téléphonique n'est pas correctement raccordée, ou est en dérangement. Utilisez uniquement le câble de raccordement téléphonique fourni.

### Certaines fonctions, par exemple l'amplification de +40 dB ou le mode mains libres ne fonctionnent pas

- Vérifiez le bloc d'alimentation.
- Vérifiez si les piles ont été correctement placées, si les piles sont du type approprié et si elles ne sont pas épuisées.

### L'affichage du numéro d'appel ne fonctionne pas

- L'affichage du numéro d'appel est un service optionnel de votre opérateur. Veuillez vous adresser à votre opérateur pour de plus amples informations.
- Le correspondant a bloqué la transmission de son numéro d'appel.

## Remarques d'entretien

- Nettoyez les surfaces du boîtier à l'aide d'un chiffon doux et non pelucheux.
- N'utilisez aucun produit nettoyant ou solution de nettoyage.

## Garantie

Les appareils AMPLICOMMS sont fabriqués et testés selon les procédés de production les plus modernes. Les matériaux choisis et la haute technologie assurent un fonctionnement parfait et une longue durée de vie. La garantie n'est pas valable si l'exploitant du réseau téléphonique ou éventuellement une installation à postes supplémentaires intercalée est responsable du dysfonctionnement de l'appareil. La garantie ne s'applique pas à la pile rechargeable standard ou aux packs de piles rechargeables utilisés dans le produit. La durée de garantie est de 24 mois à partir de la date d'achat.

Pendant la période de garantie, tous les défauts dus à des erreurs de matériel et de fabrication sont réparés gratuitement. La garantie expire en cas d'interventions de l'acheteur ou d'un tiers. Les dommages engendrés par une manipulation ou une utilisation inadéquate, par un mauvais emplacement ou rangement, par un raccordement ou une installation inadéquate ainsi qu'en cas de force majeure ou d'autres influences extérieures ne sont pas inclus dans la prestation de garantie. En cas de réclamations, nous nous réservons le droit de réparer ou de remplacer les pièces défectueuses ou d'échanger l'appareil. Les

pièces ou appareils échangés deviennent notre propriété. Tout droit de préten-  
tion à des dédommagements est exclu, sauf si ce dommage est basé sur une  
préméditation ou une négligence grave du fabricant.

Si votre appareil comporte cependant un défaut pendant la période de garan-  
tie, veuillez vous adresser exclusivement au magasin dans lequel vous avez  
acheté votre appareil AMPLICOMMS en présentant votre bon d'achat. Tous les  
droits de garantie basés sur ces dispositions ne peuvent être revendiqués  
qu'auprès de votre revendeur. A l'échéance des deux ans après l'achat et le  
transfert de nos produits, les législations en matière de garantie ne sont plus  
applicables.

## Déclaration de conformité



Cet appareil est conforme aux exigences des directives de l'UE:

EMC 2014/30/EU et LVD 2014/35/EU. La conformité avec les directives mention-  
nées ci-dessus est confirmée sur l'appareil par le symbole CE. Pour obtenir la  
déclaration intégrale de conformité, veuillez la télécharger gratuitement sur  
notre site Internet **[www.amplicomms.com](http://www.amplicomms.com)**.



## **Telefono**

- 1 Tasto di selezione
- 2 Tasto di selezione diretta M1  
(numero d'emergenza 1)
- 3 Cancellare
- 4 Tasto di selezione diretta M2  
(numero d'emergenza 2)
- 5 Sfogliare verso l'alto
- 6 Tasto di selezione diretta M3  
(numero d'emergenza 3)
- 7 Sfogliare verso il basso
- 8 LED dispositivo di telesoccorso /  
Visualizzazione nuova chiamata (vedi  
pag. 146)
- 9 Tasto di menu
- 10 Lista delle chiamate / Rubrica telefo-  
nica
- 11 Tasto R
- 12 Silenziamento microfono
- 13 Ripetizione di selezione
- 14 LED Vivavoce
- 15 Funzione vivavoce
- 16 LED Telefono squilla
- 17 Amplificare il volume della cornetta

- 18 LED Volume ricevitore aumentato
- 19 Impostazione del volume della cor-  
netta (nascosto sotto la cornetta)
- 20 Impostazione volume del suono
- 21 Impostazione suono
- 22 Impostazione volume del vivavoce

## **Dispositivo di telesoccorso**

- 1 Lanciare una chiamata d'emergenza  
automatica
- 2 LED Livello di carica della pila

<b>Mettere in funzione il telefono</b> .....	<b>128</b>
Verificare il contenuto del pacchetto .....	128
Collegamento del telefono .....	129
Montaggio alla parete .....	131
Indicazioni sul display .....	132
Impostare data/ora .....	134
Impostare lingua .....	134
<b>Telefonare</b> .....	<b>135</b>
Inserire un numero di chiamata e selezionare.....	135
Terminare la conversazione .....	135
Accettare una chiamata.....	136
Accendere/spegnere l'altoparlante .....	136
Accendere l'amplificazione del volume della cornetta .....	137
Impostare il volume della cornetta .....	137
Volume del suono.....	137
Impostare il suono della cornetta .....	137
Impostare il volume del citofono .....	138



Silenziamento del microfono.....	138
Selezionare un numero di chiamata con ripetizione di selezione .....	138
Selezionare un numero di chiamata dall'elenco delle chiamate .....	138
Scegliere un numero di chiamata dall'elenco telefonico .....	139
Selezionare un numero di chiamata a selezione diretta .....	140
Concatenare e trasmettere numeri .....	141
<b>Impostare il telefono .....</b>	<b>142</b>
Elenco telefonico .....	142
Elenco delle chiamate .....	146
Dispositivo di telesoccorso .....	149
Impostazioni .....	156
Impiego speciale.....	158

<b>Appendice</b> .....	<b>159</b>
Avvisi di sicurezza.....	159
Scopo d'uso del telefono .....	159
Luogo di posizionamento .....	159
Adattatore.....	160
Compatibilità con apparecchiature acustiche .....	160
Smaltimento.....	161
Ricerca ed eliminazione di errori.....	162
Manutenzione.....	163
Garanzia.....	163
Dichiarazione di conformità.....	164

## **Mettere in funzione il telefono**

**Importante: La preghiamo innanzitutto di leggere le istruzioni di sicurezza a pagina 159 prima di mettere in funzione il telefono.**

**Attenzione: Questo telefono può riprodurre volumi altissimi con l'amplificatore attivato e con il regolatore del volume al massimo.**

**Molta attenzione nel cambio tra utenti con udito normale e udito ridotto.**

## **Verificare il contenuto del pacchetto**

Fanno parte del volume di consegna:

- 1 telefono (apparecchio da tavola)
- 1 alimentatore di rete
- 1 cornetta
- 1 cavo con spirale per cornetta
- 1 Dispositivo di telesoccorso, applicabile a scelta al collo o sul braccio (a prova di spruzzi)
- 1 cavo di collegamento del telefono
- 4 Pile AA 1.5 V
- 1 Pila tipo 23 A, 12 V già integrata nel dispositivo di telesoccorso
- 1 supporto per montaggio a parete
- 1 istruzioni d'uso

**Importante:**

- Utilizzi l'adattatore incluso nel volume di consegna.
- Utilizzi solo il cavo di collegamento telefonico contenuto nel volume di consegna visto che l'apparecchio potrebbe non funzionare con un altro cavo di collegamento telefonico.

## Collegamento del telefono

Per poter utilizzare **tutte le funzioni** del telefono come ad es. il **vivavoce** e il **volume amplificato del ricevitore**, è necessaria un'alimentazione di corrente (adattore e batterie).

1. Inserisca le batterie nel comparto delle batterie aperto. Utilizzi esclusivamente batterie del tipo AA 1,5 V. Faccia attenzione alla polarità corretta! Chiuda il comparto delle batterie.

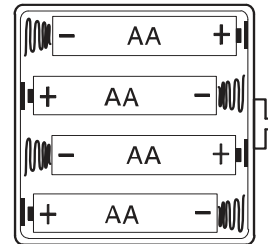

Faccia sempre attenzione al fatto che il telefono non sia collegato con il collegamento del telefono e/o il collegamento con l'adattatore, quando inserisce o sostituisce le batterie.

2. Colleghi il telefono come rappresentato sullo schizzo. Utilizzi solo il cavo del telefono contenuto nel volume di consegna visto che l'apparecchio eventualmente potrebbe non funzionare con un altro cavo di collegamento del telefono.

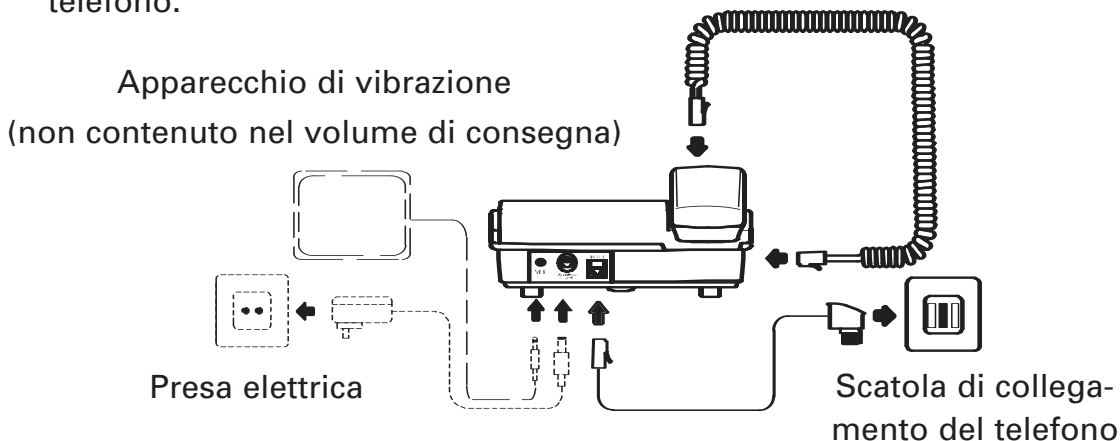

**Per usare un apparecchio di vibrazione adeguato inserisca la presa dell'apparecchio di vibrazione nella scatola „Vibrat.“ del telefono. Non sono necessarie ulteriori impostazioni. L'apparecchio di vibrazione non fa parte del volume di consegna.**

## Montaggio alla parete

Il Suo telefono è adatto per essere montato alla parete. Per fissare il telefono servono due viti.

Inserisca le chiavi (1) del supporto per il montaggio alla parete (2) nelle scanalature (3) sul retro del telefono. Spinga il supporto per il montaggio alla parete (2) 10 mm verso l'alto fino a che non entri in modo acusticamente percepibile.

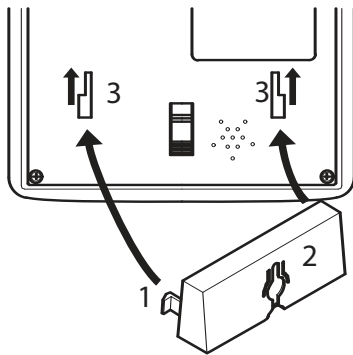

**Avvertenza: Nel settore dei fori da eseguire non si devono trovare condotti (cavi, tubi, ecc.).**

Esegua due fori nella distanza dei punti di appensione previsti e faccia fuoriuscire le viti dalla parete di 5 mm. Metta il telefono sulle viti dei punti di appensione e lo spinga un poco verso il basso.

Faccia ruotare i punti di appensione della cornetta (4) nella mensola della cornetta di 180° per poter appendere la cornetta.

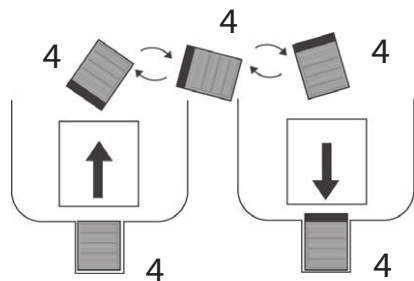

## Indicazioni sul display



Sostituisca le batterie.

14:45

Visualizzazione dell'orario.

11/06

Visualizzazione della data.



Si trova nell'elenco telefonico.

**CLIP**

Si trova nell'elenco delle chiamate.

**NEW**

L'inserimento attuale nell'elenco delle chiamate è nuovo.

**REPEAT**

Diverse chiamate da questo collegamento.

CALLS  
**01**

Visualizzazione del numero della posizione nell'elenco delle chiamate.

**TOT. : XX**

Vi sono XX inserimenti nell'elenco delle chiamate.

**NUOV: XX**

Vi sono XX nuovi inserimenti nell'elenco delle chiamate.

**VOICE**

Lampeggiante: Ci si trova nella modalità registrazione (pag. 144, 150).

















Costante: Per la voce di rubrica è stato registrato un nome.

**+**

Indica la selezione di un numero di chiamata d'emergenza (M1, M2 o M3) (pag. 152).



## Impostare data/ora

- Prema  .
- Selezioni con  /  ORA/DATA e prema  .
- Con  /  inserisca un'ora e prema  .
- Con  /  inserisca i minuti e prema  .
- Con  /  inserisca il mese e prema  .
- Con  /  inserisca il giorno e prema  .
- Esci dal menu con  .

## Impostare lingua



- Prema  .
- Selezioni con  /  LINGUA e prema  .
- Selezioni con  /  la lingua desiderata e prema  .
- Esci dal menu con  .

**Ulteriori impostazioni sono reperibili al capitolo "Impostazioni", vedi pag. 156**

# Telefonare

## Inserire un numero di chiamata e selezionare

Per chiamare qualcuno può:

- innanzitutto alzare la cornetta e poi inserire il numero di chiamata.
  - inserire un numero di telefono e poi alzare la cornetta.
- o
- inserire un numero di chiamata o premere il tasto  o il tasto .
- L'altoparlante viene acceso e il numero di chiamata viene selezionato (per il funzionamento del vivavoce è necessario l'alimentatore/batterie).
- Durante la conversazione viene indicata la durata della conversazione.

## Terminare la conversazione

Per terminare la conversazione può:

- riattaccare la cornetta.
- o
- premere il tasto  nel caso di una conversazione mediante altoparlante (si illumina la lampadina rossa nel tasto).

## Accettare una chiamata

Alzi la cornetta o prema il tasto .

## Accendere/spegnere l'altoparlante

Durante una conversazione telefonica condotta con la cornetta può commutare verso funzionamento con altoparlante (è necessario l'alimentatore/batterie).

A questo scopo prema il tasto  e riattacchi dunque la cornetta.

Se desidera continuare la conversazione con la cornetta, basta alzarla.

### **La preghiamo di attenersi a quanto segue:**

- **Durante il funzionamento dell'altoparlante la Sua lingua viene trasmessa dal microfono all'apparecchio da tavola. Parli ad una distanza di fino a 50 cm in direzione della parte anteriore dell'apparecchio da tavola.**
- **Vengono anche trasmessi rumori elevati nel Suo ambiente. Essi possono limitare la comprensione della Sua lingua presso il Suo interlocutore.**

## Accendere l'amplificazione del volume della cornetta

Il volume della cornetta può essere aumentato a +40 dB (è necessario l'alimentatore/batterie). A questo scopo preme il tasto .

Si illumina l'indicazione  „acceso“.

**Avvertenza: Questo volume potrebbe danneggiare l'udito di persone con udito normale!**

## Impostare il volume della cornetta

Può adattare il volume della cornetta con un regolatore girevole (19) (vedi pagina di inserimento).

## Volume del suono

Può adattare il volume del suono con un regolatore a spingimento (20) (vedi pagina di inserimento).

## Impostare il suono della cornetta

Può adattare il suono della cornetta con un regolatore a spingimento (21) con l'attivazione dell'amplificazione a +40dB (vedi pagina di inserimento).

## Impostare il volume del citofono

Può adattare il volume del citofono con un regolatore a spingimento (22) (vedi pagina di inserimento).

## Silenziamento del microfono

È possibile attivare e disattivare il microfono con chiamata telefonica in corso.

 tenere premuto: Disattivare il microfono (silenziamento)

 rilasciare: Attivare il microfono





## Selezionare un numero di chiamata con ripetizione di selezione

Il telefono memorizza il numero di telefono selezionato per ultimo.



- Alzi innanzitutto la cornetta o prema il tasto  e poi il tasto .

## Selezionare un numero di chiamata dall'elenco delle chiamate

Nell'elenco delle chiamate vengono salvate chiamate non accettate. Trova ulteriori informazioni nella sezione „Elenco delle chiamate“ a pagina 146.





- Alzi innanzitutto la cornetta o prema il tasto , selezioni dunque l'inserimento desiderato con i tasti  e  e prema dunque .

o





- Selezioni innanzitutto l'inserimento desiderato con i tasti  e  e alzi dunque la cornetta o prema il tasto . Si attiva l'altoparlante. Se desidera proseguire la conversazione tramite il ricevitore, lo sollevi. L'altoparlante verrà a questo punto disattivato.

## Scegliere un numero di chiamata dall'elenco telefonico

Informazioni per creare e salvare inserimenti nell'elenco telefonico Le trova nella sezione „elenco telefonico“ a pagina 142.





- Alzi innanzitutto la cornetta e prema il tasto .
- Prema il tasto , selezioni l'inserimento desiderato con i tasti  e  e prema .

o





- Prema innanzitutto il tasto , selezioni l'inserimento desiderato con i tasti  e  e alzi dunque la cornetta o prema il tasto . Si attiva l'altoparlante. Se desidera proseguire la conversazione tramite il ricevitore, lo sollevi. L'altoparlante verrà a questo punto disattivato.

## Selezionare un numero di chiamata a selezione diretta

I tasti di selezione diretta M1, M2 o M3 possono essere utilizzati per una normale selezione diretta o come posizioni di memoria per chiamate d'emergenza automatiche. Informazioni relative al salvataggio di numeri di selezione diretta / di emergenza si trovano nella sezione „Salvare numeri d'emergenza/numeri di selezione diretta“ a pagina 151.

- Alzi innanzitutto la cornetta e prema il tasto .
- Prema il tasto di chiamata di emergenza ,  o .





o

- Prema prima il tasto di chiamata di emergenza  ,  o  .
- Alzi poi la cornetta e prema il tasto  .

**Avviso: I numeri di chiamata memorizzati sui tasti di selezione diretta / chiamata di emergenza non possono essere cancellati. Quando si salvano nuovi numeri di chiamata i vecchi inserimenti vengono sovrascritti.**

## Concatenare e trasmettere numeri

La funzione viene applicata per servizi telefonici più complessi come per es. banking via telefono, call by call o procedure con calling card. Durante lo svolgimento di una chiamata è infatti possibile trasmettere diversi numeri memorizzati precedentemente nella rubrica telefonica. La trasmissione di numeri dalla rubrica telefonica è combinabile con l'immissione di numeri manuale. Con chiamata in corso è possibile combinare e trasmettere un numero illimitato di numeri tratti dalla rubrica telefonica.

- Aprire la rubrica telefonica con chiamata in corso  ,  
selezionare con  e  una voce di  
rubrica e prema  .



# Impostare il telefono

## Elenco telefonico

Nell'elenco telefonico si possono salvare 30 numeri di chiamata con i rispettivi nomi.

- Per tutti numeri di telefono inserisca sempre il prefisso per poter associare le chiamate locali in entrata ad un inserimento nell'elenco telefonico.
- Se la capacità di memorizzazione è piena, il display nel corso del prossimo salvataggio mostra un messaggio secondo cui la memoria è piena. Per creare dello spazio, deve prima cancellare un altro inserimento.
- Gli inserimenti dell'elenco telefonico sono riportati in ordine alfabetico. Per accedere direttamente all'inserimento dell'elenco telefonico desiderato, prema la lettera iniziale rispettiva.

### Inserire nomi

Sui tasti numerici sono indicate delle lettere. Premendo diverse volte sul rispettivo tasto si possono inserire lettere, cifre e simboli.









Può inserire spazi vuoti con il tasto  .

Può cancellare caratteri con  .

Per inserire due volte di seguito la stessa lettera, prema innanzitutto una volta







la lettera rispettiva. Poi attenda fino a che il cursore (riga lampeggiante) non sia saltato avanti di una posizione. Inserisca dunque nuovamente la lettera.

### Creare inserimenti nell'elenco telefonico

- Prema .
- Selezioni con  e  MEMOR. NUMERI e prema .
- Inserisca il numero di telefono e prema .
- Inserisca il nome e prema .
- Se desidera al contempo inserire un nome parlato (che venga annunciato quando lo si richiama dalla rubrica o si richiama il numero telefonico corrispondente), prema e tenga premuto .
- Pronunci il nome per questa voce e rilasci poi il tasto .

**Avvertenza: È possibile aggiungere il nome parlato a una voce della rubrica anche successivamente (v. sotto).**

## Modificare inserimenti nell'elenco telefonico

- Prema innanzitutto , selezioni dunque l'inserimento desiderato con  e .
- Prema  per ca. 3 secondi e confermi CAMBIARE con .
- Inserisca il numero di telefono nuovo e prema .
- Inserisca il nuovo nome e prema .

## Aggiungere un nome parlato

Per ogni voce della rubrica è possibile registrare un nome. Qualora poi riceva una chiamata da tale numero o selezioni la relativa voce nella rubrica, la registrazione verrà riprodotta e avrà così modo di sentire chi la chiama o quale voce abbia selezionato.

- Prema .
- Selezioni con  e  REGISTRARE NOME e prema .
- Selezioni con  e  l'inserimento desiderato.
- Prema e tenga premuto  mentre pronuncia il nome.





**Se non si rilascia il tasto, la registrazione si conclude automaticamente dopo 3 secondi.**

- Per uscire dal menu prema .

### **Cancellare un nome parlato**





- Prema .
- Selezioni con  e  REGISTRARE NOME e prema .
- Selezioni con  e  l'inserimento desiderato.
- Durante la riproduzione prema .

### **Cancellare singole voci dall'elenco telefonico**



- Prema innanzitutto , selezioni dunque l'inserimento desiderato con  e .
- Prema . Sul display appare CANCELLARE?.
- Prema  per ca. 4 secondi. L'inserimento viene cancellato.

- Per interrompere il procedimento di cancellazione prema  .

## Cancellare tutte le voci dell'elenco telefonico

- Prema innanzitutto  , selezioni dunque l'inserimento desiderato con  e  .
- Prema  per ca. 4 secondi.

Sul display appare CANCELL. TUTTI?.

- Prema nuovamente  per ca. 4 secondi.
- Per interrompere il procedimento di cancellazione prema  .

## Elenco delle chiamate

**Avviso: Per poter usufruire di questa funzione, il Suo collegamento deve avere a disposizione il trasferimento del numero di chiamata. Per ulteriori informazioni contatti il Suo gestore di rete.**

Se il Suo collegamento ha a disposizione il trasferimento del numero di chiamata (CLIP), il numero di chi chiama e/o il nome dell'interlocutore Le viene indicato o annunciato nel momento in cui suona il telefono se esiste una voce nell'elenco telefonico per questo numero di telefono. Se l'interlocutore durante il trasferimento del suo numero di chiamata lo nasconde o non è disponibile per altri motivi, viene visualizzato il rispettivo messaggio. Il numero di telefono allora non può essere visualizzato e dunque neppure essere salvato nell'elenco delle chiamate. Quando il display si trova in stand-by Lei può notare quante sono le chiamate nell'elenco delle chiamate e quante di esse sono NUOVE (non ancora viste). In totale 64 numeri di chiamate vengono salvati nell'elenco delle chiamate. Il LED rosso lampeggiante visualizza che sono state salvate nuove chiamate nell'elenco delle chiamate. **Questo LED lampeggia finché registra la presenza di voci non visualizzate. Per arrestare il lampeggiamento, premere ripetutamente il tasto** .

### Visualizzare il numero di chiamata nell'elenco delle chiamate

- Selezioni un inserimento con  e .





### Salvare un numero di chiamata nell'elenco delle chiamate nell'elenco telefonico

- Selezioni un inserimento con  e .
- Prema  per ca. 3 secondi e confermi con **COPIARE A MEM.** con .



- Il numero telefonico è memorizzato in rubrica senza nome. Per inserire anche un nome da abbinare al numero telefonico vedi „**Modificare inserimenti nell'elenco telefonico**“.

**Avviso: Non appena al numero di chiamata memorizzato in rubrica è abbinato un nome, l'elenco chiamate visualizza in più anche il nome inserito.**

### **Cancellare singoli inserimenti**

- Selezioni un inserimento con  e .
- Prema . Sul display appare CANCELLARE?.
- Prema  per ca. 4 secondi. L'inserimento viene cancellato.

### **Cancellare l'elenco completo delle chiamate**

- Selezioni un inserimento con  e .
- Prema  per ca. 4 secondi.  
Sul display appare CANCELL. TUTTI?.

- Prema  nuovamente per ca. 4 secondi.

**Avviso: Prima di cancellare numeri telefonici, verificare che le voci interessate siano già state visualizzate.**

## Dispositivo di telesoccorso

Il dispositivo di telesoccorso consente di lanciare una richiesta di telesoccorso a speciali servizi d'emergenza domestica o a determinate persone.

**Avviso: Sono numerosi i servizi d'emergenza domestica idonei, come ad es. Croce rossa, Croce rossa maltese, Soccorso dell'Ordine di S. Giovanni. In alcuni paesi l'uso di servizi d'emergenza domestica sono soggetti a pagamento.**

**Il presente apparecchio può anche essere utilizzato come dispositivo d'emergenza circoscritto alla propria famiglia.**

## Messaggio d'emergenza

La configurazione iniziale prevede un messaggio d'emergenza predefinito. Questo messaggio d'emergenza può essere sostituito da un messaggio d'emergenza personale. Per lanciare una chiamata d'emergenza automaticamente, il telefono chiama in automatico i numeri telefonici precedentemente memorizzati sui tasti **M1**, **M2** e **M3**. Il messaggio d'emergenza è riprodotto fin-



tanto che una delle persone chiamate non accetta la chiamata premendo il tasto "0". Si consiglia infatti di concludere il proprio messaggio d'emergenza sempre con la frase **"Per accettare questa emergenza, premere il tasto 0!"** .

**Avviso: Assicurarsi inoltre che il chiamato sia in grado di riconoscere il mittente della chiamata d'emergenza. Indicare nel messaggio che si tratta di una chiamata d'emergenza e che si ha bisogno di aiuto.**





### Registrare il messaggio d'emergenza

- Prema  .
- Selezioni con  /  REGIS. MESSAGGIO e prema  .
- Tenere premuto  e avviare la registrazione.
- Per terminare l'annuncio rilasci  .

### Riprodurre il messaggio d'emergenza









- Prema  .
- Selezioni con  /  CONTROLL. MESS. e prema  .

## Cancellare il messaggio d'emergenza

- Prema .
- Selezioni con  /  **CONTROLL.MESS.** e prema .
- Durante la riproduzione prema . L'annuncio viene cancellato.

## Salvare numeri d'emergenza/numeri di selezione diretta

I tasti di selezione diretta M1, M2 e M3 possono essere utilizzati per una normale selezione diretta o come posizioni di memoria per chiamate d'emergenza automatiche.

- Prema .
- Selezioni con  /  **MEMOR. NUMERI** e prema .
- Immettere il numero di chiamata (max. 22cifre) e prema .
- Selezionare il tasto di selezione diretta  ,  o  e prema .

**Avviso: I numeri di chiamata memorizzati sui tasti di selezione diretta non possono essere cancellati. Memorizzando nuovi numeri di chiamata, eventuali voci precedentemente memorizzate sono sovrascritte.**

## Chiamata d'emergenza automatica

Per lanciare una chiamata d'emergenza automatica, premere e tenere premuto i tasti **M1**, **M2** o **M3** del telefono o del dispositivo di telesoccorso.

Non avendo memorizzato alcun numero su uno dei tasti **M1**, **M2** o **M3**, il telefono non seleziona alcun numero limitandosi invece al rilascio di un segnale d'emergenza ad alto volume.

**Avviso: Assicurarsi che il dispositivo di telesoccorso si trovi entro il raggio di portata del telefono.**

**La batteria del dispositivo di telesoccorso dovrebbe essere sempre carica.**

## Chiamata d'emergenza automatica tramite telefono

- Prema **M1**, **M2** o **M3** per circa 5 secondi per avviare la chiamata d'emergenza automatica.
- Prema  o nuovamente **M1**, **M2** o **M3** per circa 5 secondi per terminare la chiamata d'emergenza automatica.

## Chiamata d'emergenza automatica tramite dispositivo di telesoccorso

1. Tenere premuto per 5 secondi il tasto (1) sul dispositivo di telesoccorso per avviare la chiamata d'emergenza automatica.
2. Tenere nuovamente premuto per 5 secondi il tasto sul dispositivo di telesoccorso per concludere la chiamata d'emergenza automatica.

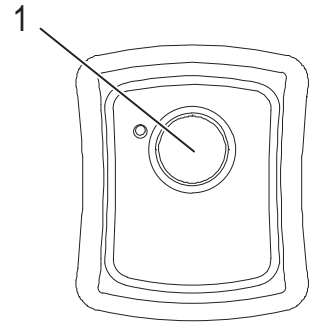

## Avviare / Concludere la chiamata d'emergenza automatica

Al momento del lancio di una chiamata d'emergenza automatica, il telefono si comporta come segue:

1. L'altoparlante del dispositivo di telesoccorso si inserisce. Il dispositivo emette per una durata di 15 secondi il segnale "Chiamata d'emergenza attiva".
2. Segue il segnale di linea libera e i numeri di chiamata memorizzati sui tasti **M1**, **M2** e **M3** sono selezionati automaticamente uno dopo l'altro con un intervallo di tempo di ca. 60 secondi. L'annuncio di emergenza precedentemente registrato è riprodotto all'infinito.
3. Non appena qualcuno risponde alla chiamata, il dispositivo riproduce il messaggio d'emergenza. Premendo il **tasto "0"** la persona disattiva l'annuncio di emergenza. La telefonata che segue ha una durata di 3 minuti e si svolge con vivavoce del dispositivo di telesoccorso inserito.

4. Trascorsi 3 minuti, il collegamento è interrotto. A questo punto il telefono tenta di instaurare un collegamento con i numeri di chiamata memorizzati sui tasti **M1**, **M2** e **M3**.
5. Se la chiamata è interrotta prima dello scadere dei 3 minuti o se si riaggancia, il dispositivo ritenta di instaurare un collegamento con il numero telefonico successivo, finché non saranno stati chiamati tutti e 3 i numeri memorizzati. Sul dispositivo di telesoccorso si avverte un segnale di linea occupata.

**Avviso: Per concludere la chiamata d'emergenza, tenere premuto il tasto sul dispositivo di telesoccorso oppure i tasti M1, M2, M3 per 5 secondi.**

### **Controllare la pila del dispositivo di telesoccorso**

1. Tenere brevemente premuto il tasto (1) sul dispositivo di telesoccorso. Il LED (2) si accende.
2. Se il LED (2) non si accende più mentre si preme il tasto, sostituire la pila.

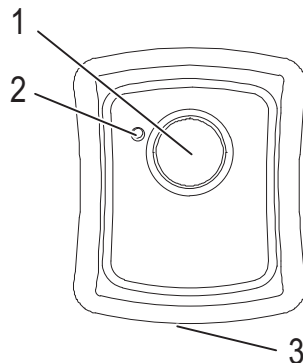



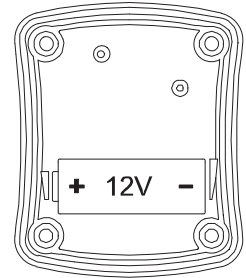

## Sostituire la pila



1. Rimuovere la vite sul retro del dispositivo di telesoccorso con un piccolo cacciavite a croce.
2. Aprire l'involucro con l'ausilio di un piccolo cacciavite introducendolo nella tacca (3).
3. Sostituire la pila. Utilizzare solo pile dello stesso tipo. Osservare la corretta polarità!
4. Richiudere l'involucro.



## Impostazioni

Sul suo telefono può eseguire diverse impostazioni.

- Prema  . **Il menù si apre.**
- Si sposti con  e  sulla voce di menu desiderata e prema  per aprire il rispettivo sottomenu.

CONTRASTO LCD (1-5)    Modifichi l'impostazione con  e  e prema , per mantenere l'impostazione attuale.

ORA/DATA    vedi pag. 134.

MEMOR. NUMERI    vedi pag. 143, 151.

REGISTRARE NOME    vedi pag. 144.

REGIS. MESSAGGIO    vedi pag. 150.

CONTROLL. MESS.    vedi pag. 150.

LINGUA    vedi pag. 134. Per l'impostazione di messaggi di annuncio e testi di display del telefono è possibi-





## FLASH

le scegliere tra 4 lingue.

Per l'uso di caratteristiche di prestazione nella rete analogica risulta corretto il tempo flash di 100 ms. Nel caso ad es. del funzionamento in combinazione con un impianto di telecomunicazione potrebbe comunque essere necessario impostare un tempo flash di 300 ms. Per ulteriori informazioni La preghiamo di consultare le istruzioni d'uso dell'impianto.

## MEL. SQUILLO (1-3)

Modifichi l'impostazione con  e  e prema , per mantenere l'impostazione attuale.

## VOCE

La pressione di alcuni tasti è in più accompagnata da una voce. La voce può essere attivata o disattivata.

- Prema  per uscire dal menu.



## Impiego speciale

### Funzionamento in combinazione con un impianto telefonico

Se mette in funzione il Suo telefono in combinazione con un impianto telefonico (se ad esempio deve selezionare „0“ per prendere una linea ufficiale), per le funzioni d'intermediazione offerte dall'impianto, usi il tasto  .

Per la lunghezza del Suo segnale flash richiesto dal Suo impianto La preghiamo di consultare la documentazione del Suo impianto telefonico.

### Inserire pausa di selezione

Se desidera inserire una pausa di selezione all'interno di un numero di telefono, prema il tasto  sul punto rispettivo.

### Usufruire di servizi di gestori di rete

Con il Suo telefono può anche usufruire di servizi di gestori di rete quale „bus-sare“ o „conferenza“. La preghiamo di richiedere informazioni presso il Suo gestore di rete per ottenere i dettagli in merito.

# Appendice

## Avvisi di sicurezza

Legga attentamente le istruzioni d'uso e Le conservi per bene.

## Scopo d'uso del telefono

Questo telefono analogico è previsto per il collegamento a una rete telefonica o a un impianto di telefonia privato. Tutti gli altri usi sono scorretti. Modifiche o ristrutturazioni autonome non sono ammesse. Non deve assolutamente aprire l'apparecchio e ripararlo autonomamente.

## Luogo di posizionamento

La preghiamo di attenersi a quanto segue:

- Posizioni il Suo telefono su una superficie piana e diritta e/o lo fissi alla parete.
- Monti i cavi di collegamento evitando la formazione di trappole su cui inciampare.
- Si assicuri che la presa con l'adattatore sia accessibile in ogni momento per poter disconnettere rapidamente l'apparecchio dalla rete.
- Mantenga una distanza di ca. 1 metro dagli altri apparecchi elettronici al fine di evitare interferenze reciproche.
- Eviti sollecitazioni causate da fumo, polvere, urti, sostanze chimiche, umidità, calore o insolazione diretta.

## Adattatore

**Attenzione: Utilizzi esclusivamente l'adattatore contenuto nel volume di consegna visto che altri adattatori potrebbero danneggiare il telefono. Non deve bloccare l'accesso all'adattatore con mobili o altri oggetti.**

L'adattatore contenuto nel volume di consegna corrisponde ai requisiti del design ecologico dell'UE per i prodotti a funzionamento elettrico (direttiva CEE 32 del 2005).

Il consumo energetico per questo è notevolmente ridotto sia in condizioni di funzionamento che di disponibilità rispetto agli adattatori di modelli più vecchi.



- Energiesparend
- Economisant l'énergie
- A risparmio di energia
- Energy efficient

## Compatibilità con apparecchiature acustiche

Questo telefono è compatibile con la maggior parte delle apparecchiature acustiche in commercio. A causa del nostro ampio spettro di ausili acustici non possiamo dunque garantire che questo telefono sia utilizzabile completamente con ogni tipo di apparecchio acustico.

**Importante: Con l'"amplificazione" accesa, il livello del volume di questo telefono può essere molto alto. Per questo si deve fare attenzione quando questo telefono viene utilizzato anche da persone con udito normale.**

## Smaltimento

E' obbligata/o a smaltire correttamente i prodotti d'uso. Il simbolo qui a lato riportato sul Suo telefono indica che gli apparecchi elettrici ed elettronici e le batterie usati devono essere smaltiti separatamente dai rifiuti domestici.



Smaltisca gli apparecchi elettrici o elettronici presso il punto di raccolta di un gestore adeguato addetto allo smaltimento.

Smaltisca le batterie presso il rivenditore di batterie o i punti di raccolta competenti che mettono a disposizione i rispettivi contenitori.

Smaltisca i materiali d'imballaggio ai sensi delle prescrizioni locali.



## Ricerca ed eliminazione di errori

Se ha problemi con il Suo telefono, controlli innanzitutto i seguenti avvisi. In caso di problemi tecnici e diritti di garanzia si rivolga al Suo rivenditore specializzato.

La durata di garanzia ammonta a 2 anni.

### Conversazione telefonica impossibilitata

- Linea telefonica collegata in modo scorretto o disturbata. Utilizzi esclusivamente il cavo di collegamento telefonico contenuto nel volume di consegna.

### Alcune funzione, ad es. l'amplificazione di +40 dB o quello del citofono, non funzionano più.

- Controlli l'adattatore.
- Controlli se le batterie sono inserite correttamente, se il tipo di batteria corrisponde e se non sono scariche.

### Non funziona la visualizzazione del numero di telefono

- La visualizzazione del numero di telefono è un servizio aggiuntivo del Suo gestore di rete. La preghiamo di richiedere ulteriori informazioni al Suo gestore di rete.
- Chi chiama ha nascosto il proprio numero di telefono durante la chiamata.

## Manutenzione

- Pulisca la superficie dell'apparecchio sempre con una pezza morbida e priva di peluzzi.
- Non utilizzi mai detergenti e solventi.

## Garanzia

Gli apparecchi di AMPLICOMMS vengono prodotti e controllati secondo le procedure di produzione più innovative. L'uso di materiali selezionati con attenzione e di tecnologie altamente sviluppate garantisce un funzionamento privo di disturbi e un ciclo di vita lungo. Le condizioni di garanzia non si applicano se la causa del disturbo nell'apparecchio va ricondotta al gestore della rete telefonica o a un eventuale impianto secondario interconnesso. La garanzia non si applica alle batterie ricaricabili, gli accumulatori o i pacchetti di batterie impiegate nei prodotti. La durata di garanzia ammonta a 24 mesi a partire dalla data d'acquisto.

All'interno del periodo di garanzia tutte le carenze riconducibili a errori di materiale o di produzione vengono eliminate gratuitamente. Il diritto di garanzia si estingue dopo interventi del compratore o di terzi. Danni causati da uso o maneggio scorretti, posizionamento o conservazione errati, collegamenti scorretti o installazione errata, forza maggiore o altri influssi esterni non sono contenuti nella prestazione di garanzia.

Ci riserviamo il diritto di riparare o sostituire parti difettose in caso di reclami e/o di mettere a disposizione un apparecchio sostitutivo. Parti o apparecchi sostituiti diventano di nostra proprietà.

Diritti di risarcimento danni sono esclusi almeno che al produttore non si dimostri di aver agito con premeditazione e grave negligenza.

Se il Suo apparecchio dovesse evidenziare un difetto durante il periodo di garanzia, La preghiamo di rivolgersi al negozio in cui ha acquistato il Suo apparecchio AMPLICOMMS, presentando il Suo scontrino di acquisto. Tutti i diritti di garanzia secondo queste normative sono da far valere esclusivamente presso il rivenditore specializzato.

Due anni dopo l'acquisto dei prodotti non si possono più far valere diritti di garanzia.

## Dichiarazione di conformità

Questo dispositivo è conforme ai requisiti delle direttive UE:  
EMC 2014/30/EU e LVD 2014/35/EU.



La conformità con las direttivas sopra citata viene confermata con il simbolo CE sull'apparecchio.

La dichiarazione di conformità completa la puo scaricare gratuitamente dal nostro sito web allo **[www.amplicomms.com](http://www.amplicomms.com)** .







Audioline GmbH  
Carl-Schurz-Str. 2  
41460 Neuss  
Germany

03/2018 – Edition 2.0

