

Neogard AG
 5728 Gontenschwil / Schweiz
 Oberkulmerstrasse - Postfach 32
 Tel.: 062/ 767 00 50
 Fax: 062/ 767 00 67
 E-mail: info@neogard.ch



Fabrikation von Garten- und Do-it-yourself-Artikeln

neogard

Montage – Anleitung
 Art.-Nr. 7802.107

Instruction de montage
 KST-Geräteschrank 143x77cm H: 105/120cm

Instruzioni per il montaggio



MINI SHED
English Assembly instructions

MINI REMISE
Français Instructions de montage

MINI SCHUPPEN
Deutsch Montageanleitung

COBERTIZO MINI
Español Instrucciones de ensamble

MINIBERGING
Nederlands Montagehandleiding

MINI MAGAZZINO
Italiano Istruzioni di montaggio



• Bis zu 20kg/45lb. je Regal
 • Max. 20kg/45lb. per estante
 • Max. 20kg/45lb. per plank
 • Peso massimo per scaffale: 20kg/45lb.

KETER®

A-160-0

7802.107

Assembly parts • Pièces à assembler • Montageteile • Piezas de ensamble • Onderdelen • Parti di assemblaggio

A X1
Fr. 30.--

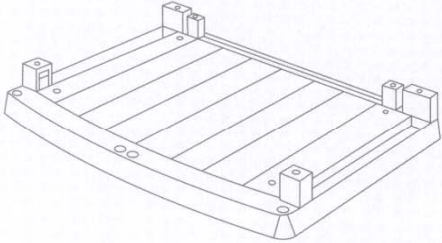

F X2
à Fr. 15.--

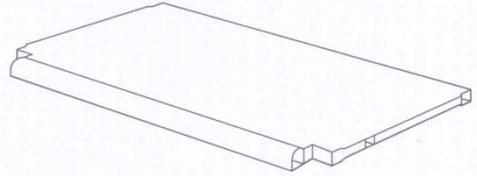

E X1
Fr. 30.--



H X1
Fr. 5.--

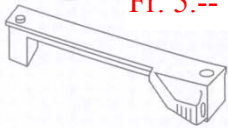

G X1
Fr. 5.--

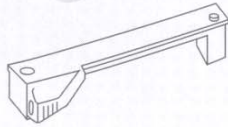

W_L X1
Fr. 20.--



D_R X1
Fr. 20.--

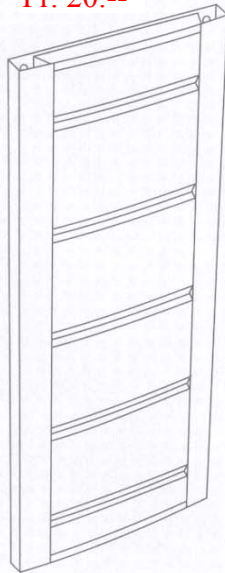

S X2
à Fr. 15.--



N X1
Fr. 5.--



Z X1
Fr. 5.--

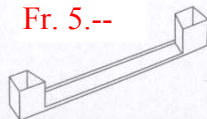

B X1
Fr. 15.--

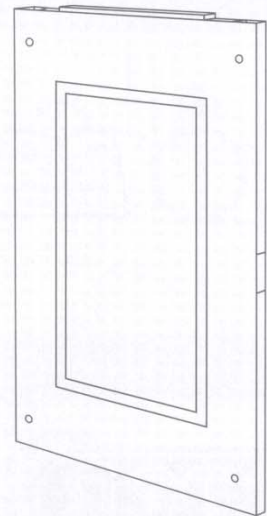

1

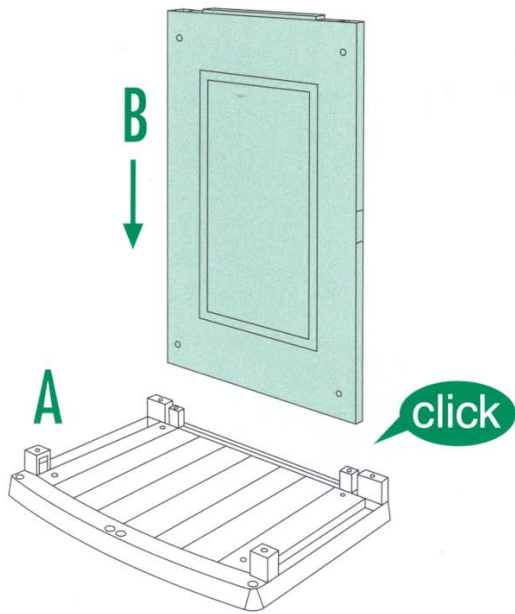

- **Recommendation:** For easier assembly use lubricant on parts to be assembled (e.g. silicon spray or petroleum jelly).
- **Conseil:** Pour faciliter l'assemblage, appliquez un lubrifiant (silicone, vaseline, etc.) sur les pièces à assembler.
- **Empfehlung:** Um den Aufbau zu erleichtern, bitte schmieren Sie die Montageteile leicht mit einem Silikone Spray oder mit Vaseline ein.
- **Recomendación:** Para montar facilmente aplique un lubricante (silicone o vaseline) sobre las piezas a montar.
- **Aanbeveling:** Smeer een smeermiddel op de onderdelen die in elkaar gezet moeten worden, om het in elkaar zetten makkelijker te maken (b.v. silicon spray of petroleum jelly).
- Per un montaggio più semplice, **Si raccomanda** de usare del lubrificante sulle parti da montare (p.e. spray al silicone o petrolato)

2

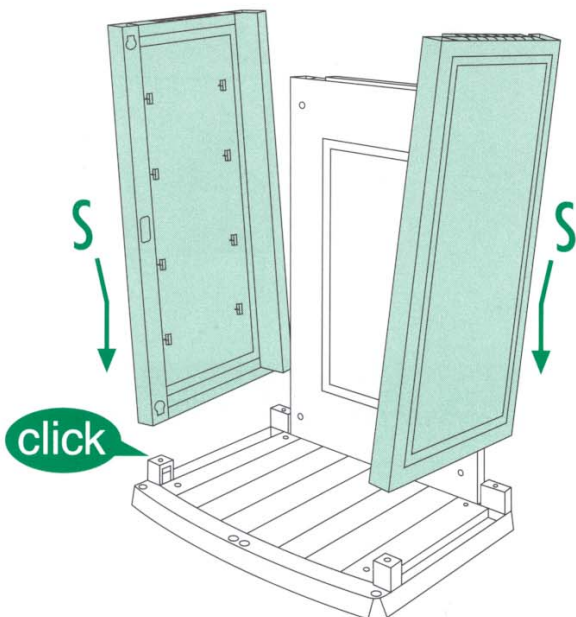

3

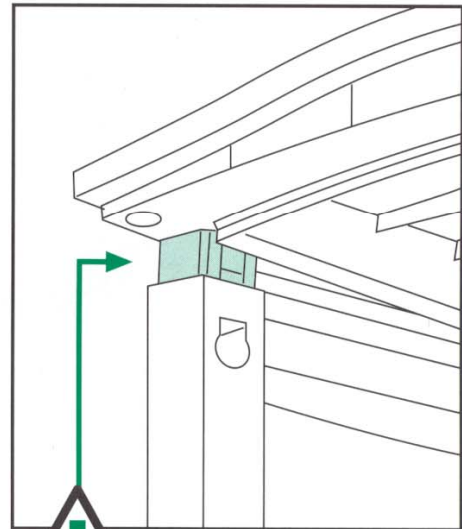
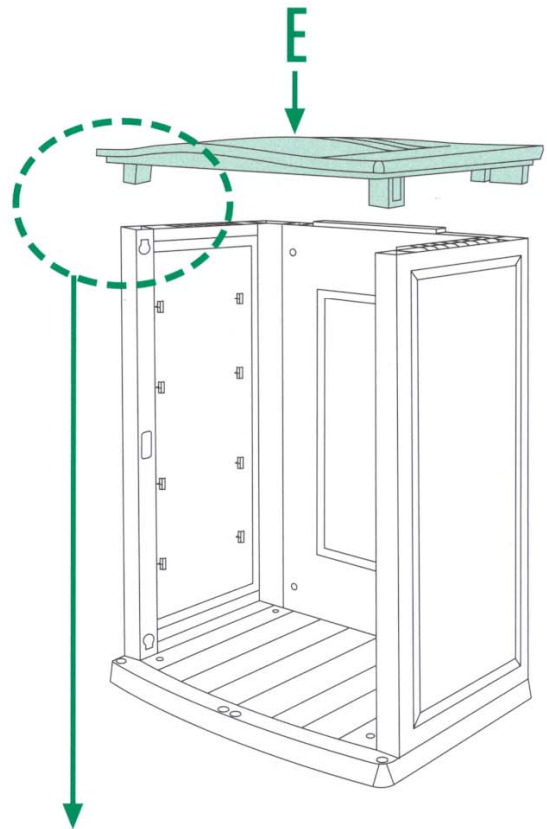

- Leave open
- Laissez ouvert
- Offen lassen
- Dejar abierto
- Laat open
- Lasciare aperto

Option
Option
Option
Opción
Optie
Opzione

A



- To mount on wall.
- Fixer la remise au mur.
- Wandmontage.
- Para montar sobre la pared.
- Aan de muur te bevestigen.
- Montaggio al muro.

4

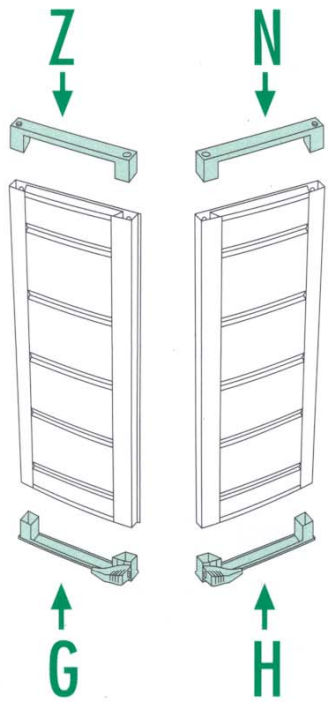

5

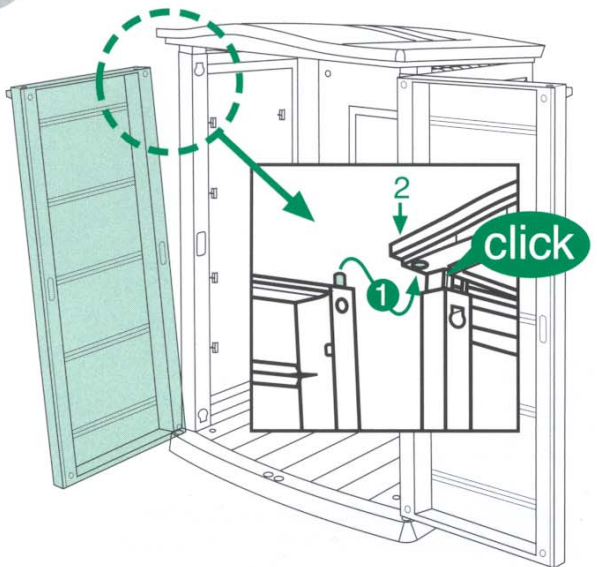

6

- Screw the shed to the wall as illustrated.
- Vissez la remise au mur (voir illustration).
- Schrauben Sie nun den Wandschrank, wie in der Abbildung zu sehen, an die Wand.
- Atornillar el cobertizo a la pared (ver la ilustración).
- Draai daarna de berging aan de muur vast, zoals in de illustratie is afgebeeld.
- Fissare poi il magazzino al muro avvitando come da figura.



7



Option
Option
Option
Opción
Optie
Opzione

B



- To place on floor.
- Placer la remise à même le sol.
- Auf den Boden stellen
- Poner el cobertizo sobre el suelo
- Op de vloer plaatsen.
- Collocare sul pavimento

4

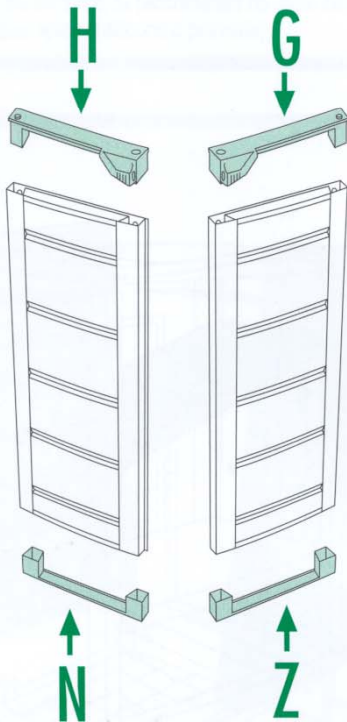

5

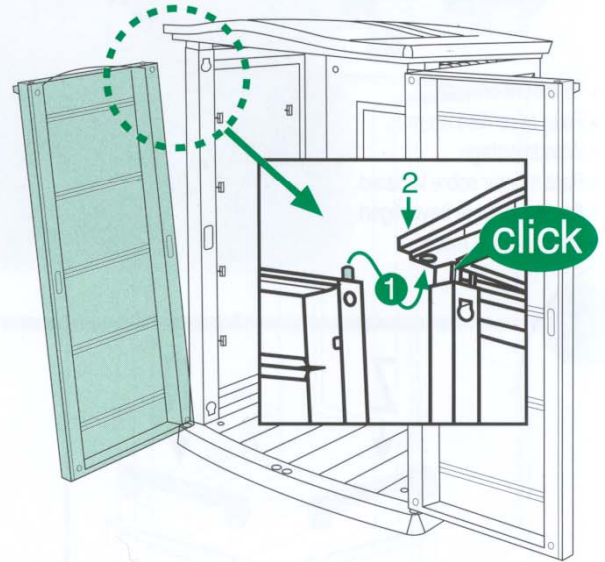

6



- Place shed on levelled surface
- Placez la remise sur une surface plate
- Schuppen auf ebene Fläche stellen
- Coloque el cobertizo sobre una superficie plana
- Plaats de berging op een plat oppervlak
- Situare il Magazzino su una superficie piana e uniforme

7802.107

- **Pegboard:** Optional accessory kit for Mini Shed
- **Panneau à outils:** Kit optionnel pour Mini Remise
- **Werkzeugplatte:** Zusätzlich erwerbbarer ubehörsatz für A Mini Schuppen
- **Tablero de Herramientas:** Set opcional para Cobertizo Mini
- **Gereedschapsbord:** Aanbevolen kit voor gebruik met Miniberging
- **Pannelo per utensili:** Corredo di accessori disponibile per il Magazzino Mini

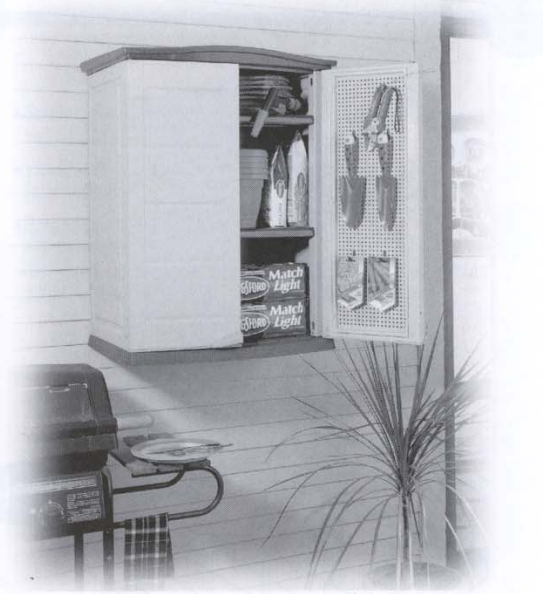

Pegboard
Panneau à outils
Werkzeugplatte
Tablero de Herramientas
Gereedschapsbord
Pannelo per utensili

Fr. 11.--

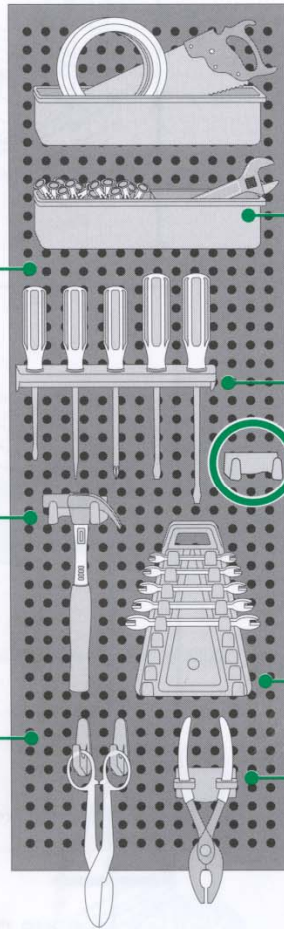

Hammer holder
Support pour marteau
Halierung für Hammer
Portamartillo
Hammerhouder
Gancio per martello

Fr. 5.--

Multi-purpose hook
Crochet multifonction
Vielzweckhaken
Clavija multiuso
Haak voor veelvuldig gebruik
Gancio multiuso

à Fr. 3.--

General Box
Boîte multifonction
Vielzweckkästchen für Kleinteile
Caja multiuso
Doos voor kleine werktuigen
Valigetta multiusi

à Fr. 9.--

Screwdriver holder
Support pour tournevis
Halierung für Schraubenzieher
Portadestornillador
Houder voor schroevendraaier
Supporto per giraviti

Fr. 7.--

Wrench holder
Support pour clé anglaise
Halierung für Schraubenschlüssel
Portallaves
Houder voor Engelse sleutel
Supporto per chiavi inglesi

Fr. 7.--

Pliers, spanner holder
Support pour pinces et tenailles
Halierung für Zangen
Porta alicates
Tanghouder
Supporto per pinze

Fr. 5.--

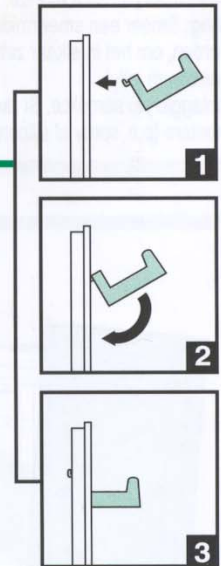

Customer service • Service clientèle • Kundenservice • Servizio al cliente • Klantenservice • Servizio consumatori

USA
Call Toll Free Number: 1-(888)-374-4262
Canada
Call Toll Free Number:
Appel gratuit: 1-(800)-661-6721

United Kingdom:
Keter (UK) Ltd.
Unit 4, Woodgate Business Park, Clapgate Lane,
Birmingham, B32 - 3DB, United Kingdom.
Tel: 0121-4226633, Fax: 0121-4220808

Other European Countries:
Keter Europe Gardening
Ericssonstraat 17, Postbus 224, 5120 AE Rijen, the Netherlands.
Tel: 31-1612-28301, Fax: 31-1612-28322