

# SHARP®

MODEL

LC-70LE740E

LC-70LE740RU

LC-70LE741E

LC-70LE741S

LC-60LE740E

LC-60LE740RU

LC-60LE741E

LC-60LE741S

OPERATION MANUAL

LCD COLOUR TELEVISION

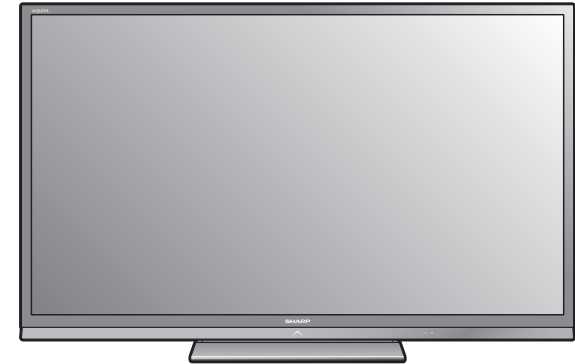

AQUOS 3D







**CE 0700** 

**CE Statement:**  
Hereby, SHARP Electronics (Europe) GmbH declares that the wireless LAN USB adapter (WN8522D 7-JU) is in compliance with the essential requirements and other relevant provisions of Directive 1999/5/EC. The declaration of conformity may be consulted at: [http://www.sharp.de/doc/WN8522D\\_7.pdf](http://www.sharp.de/doc/WN8522D_7.pdf).

**NOTE**  
The wireless LAN USB adapter is designed for **indoor use only**.

**SPECIAL NOTE FOR USERS IN THE U.K.**

The mains lead of this product is fitted with a non-rewireable (moulded) plug incorporating a 13A fuse. Should the fuse need to be replaced, a BSI or ASTA approved BS 1362 fuse marked  or  and of the same rating as above, which is also indicated on the pin face of the plug, must be used.  
Always refit the fuse cover after replacing the fuse. Never use the plug without the fuse cover fitted.  
In the unlikely event of the socket outlet in your home not being compatible with the plug supplied, cut off the mains plug and fit an appropriate type.

**DANGER:**  
The fuse from the cut-off plug should be removed and the cut-off plug destroyed immediately and disposed of in a safe manner.  
Under no circumstances should the cut-off plug be inserted elsewhere into a 13A socket outlet, as a serious electric shock may occur.  
To fit an appropriate plug to the mains lead, follow the instructions below:

**IMPORTANT:**  
The wires in the mains lead are coloured in accordance with the following code:  
**Blue: Neutral**  
**Brown: Live**

As the colours of the wires in the mains lead of this product may not correspond with the coloured markings identifying the terminals in your plug, proceed as follows:  
The wire which is coloured blue must be connected to the plug terminal which is marked N or coloured black.  
The wire which is coloured brown must be connected to the plug terminal which is marked L or coloured red.  
Ensure that neither the brown nor the blue wire is connected to the earth terminal in your three-pin plug.  
Before replacing the plug cover make sure that:  
If the new fitted plug contains a fuse, its value is the same as that removed from the cut-off plug.  
The cord grip is clamped over the sheath of the mains lead, and not simply over the lead wires.  
**IF YOU HAVE ANY DOUBT, CONSULT A QUALIFIED ELECTRICIAN.**

## Dear SHARP customer

Thank you for your purchase of the SHARP LCD colour TV product. To ensure safety and many years of trouble-free operation of your product, please read **Important safety precautions** carefully before using this product.

## Contents

<b>Introduction</b> .....	<b>1</b>	<b>Basic adjustment</b> .....	<b>31</b>	<b>Enjoying 3D image viewing</b> .....	<b>61</b>
Dear SHARP customer.....	1	Picture settings.....	31	Display format for 3D and 2D images .....	62
Contents.....	1	Audio settings .....	33	Viewing 3D images.....	63
Important safety precautions .....	2	Power save settings .....	34	Configuring the TV settings to enhance 3D image viewing .....	64
Supplied accessories .....	4	View settings .....	35	Troubleshooting – 3D Images.....	66
Optional accessories.....	4	TV start-up time setting.....	38	<b>Appendix</b> .....	<b>67</b>
<b>Preparation</b> .....	<b>5</b>	Individual setting – PIN.....	38	Troubleshooting.....	67
Attaching the stand unit .....	5	Individual setting – Clock .....	38	Updating your TV via DVB-T/T2*1/C/S*2/S2*2...	68
Using the remote control unit.....	6	Individual setting – Language.....	39	Getting update information .....	68
<b>Part names and functions</b> .....	<b>7</b>	<b>Useful viewing functions</b> .....	<b>40</b>	Information on the software licence for this product.....	69
TV (front/side view).....	7	Optional features settings .....	40	Updating your TV via USB/network .....	69
TV (rear view).....	7	Additional features .....	43	Trademarks.....	70
Remote control unit.....	8	<b>Other useful features</b> .....	<b>44</b>	Software licences for Net TV.....	71
<b>Quick guide</b> .....	<b>9</b>	Time shift +.....	44	Disclaimers for services using the Internet .....	71
Operation overview .....	9	How to operate Time shift +.....	45	Specifications.....	72
Inserting the CA card into the CI module.....	11	USB media/Home network .....	48	Specifications (Wireless LAN USB adapter).....	73
Using the HOME screen.....	12	USB device compatibility .....	51	Environmental specifications .....	74
<b>Initial auto installation</b> .....	<b>14</b>	Home network server compatibility .....	51	Mounting the TV on a wall.....	74
Initial auto installation.....	14	Selecting the picture size for video mode.....	51	Dimensional drawings .....	76
<b>Watching TV</b> .....	<b>18</b>	<b>Connecting a PC</b> .....	<b>52</b>	EU Energy Label for Televisions.....	77
Daily operation .....	18	Connecting a PC.....	52		
EPG .....	20	Displaying a PC image on the TV.....	52		
Teletext .....	22	PC control of the TV.....	55		
<b>Connecting external devices</b> .....	<b>23</b>	<b>Network setup</b> .....	<b>57</b>		
Introduction to connections .....	23	Connecting to the network.....	57		
Video connections.....	24	<b>Net TV</b> .....	<b>59</b>		
Audio connections .....	26	What is Net TV?.....	59		
<b>AQUOS LINK</b> .....	<b>27</b>	Operations in Net TV .....	59		
Controlling HDMI devices using AQUOS LINK...27					
AQUOS LINK connection .....	28				
AQUOS LINK setup.....	29				
Operating an AQUOS LINK device .....	29				

\*1 741 series only

\*2 740 series only

## NOTE

- The illustrations and the OSD in this operation manual are for explanation purposes and may vary slightly from the actual operations.
- The examples used throughout this manual are based on 70 inch models.

### Important safety precautions

- **Cleaning**—Unplug the AC cord from the AC outlet before cleaning the product. Use a damp cloth to clean the product. Do not use liquid cleaners or aerosol cleaners.
- Use a soft damp cloth to gently wipe the panel when it is dirty. To protect the panel, do not use a chemical cloth to clean it. Chemicals may cause damage or cracks in the cabinet of the TV.
- **Water and moisture**—Do not use the product near water, such as bathtub, washbasin, kitchen sink, laundry tub, swimming pool and in a wet basement.
- Do not place vases or any other water-filled containers on this product. The water may spill onto the product causing fire or electric shock.
- **Stand**—Do not place the product on an unstable cart, stand, tripod or table. Doing so can cause the product to fall, resulting in serious personal injuries as well as damage to the product. Use only a cart, stand, tripod, bracket or table recommended by the manufacturer or sold with the product. When mounting the product on a wall, be sure to follow the manufacturer's instructions. Use only the mounting hardware recommended by the manufacturer.
- When relocating the product placed on a cart, it must be moved with utmost care. Sudden stops, excessive force and uneven floor surface can cause the product to fall from the cart.
- **Ventilation**—The vents and other openings in the cabinet are designed for ventilation. Do not cover or block these vents and openings since insufficient ventilation can cause overheating and/or shorten the life of the product. Do not place the product on a bed, sofa, rug or other similar surface, since they can block ventilation openings. This product is not designed for built-in installation; do not place the product in an enclosed place such as a bookcase or rack, unless proper ventilation is provided or the manufacturer's instructions are followed.
- The LCD panel used in this product is made of glass. Therefore, it can break when the product is dropped or impact applied. If the LCD panel is broken, be careful not to be injured by broken glass.
- **Heat sources**—Keep the product away from heat sources such as radiators, heaters, stoves and other heat-generating products (including amplifiers).
- To prevent fire, never place any type of candle or naked flames on the top or near the TV set.
- To prevent fire or shock hazard, do not place the AC cord under the TV set or other heavy items.



- **Headphones**—Do not set the volume at a high level. Hearing experts advise against extended listening at high volume levels.
- Do not display a still picture for a long time, as this could cause an afterimage to remain.
- There is power consumption always if main plug is connected.
- **Servicing**—Do not attempt to service the product yourself. Removing covers can expose you to high voltage and other dangerous conditions. Request a qualified person to perform servicing.

The LCD panel is a very high technology product, giving you fine picture details.

Due to the very large number of pixels, occasionally a few non-active pixels may appear on the screen as a fixed point of blue, green or red. This is within product specifications and does not constitute a fault.

#### Precautions when transporting the TV

When transporting the TV, never carry it by putting pressure onto the display. Be sure to always carry the TV by two people holding it with two hands—one hand on each side of the TV.

#### Caring for the cabinet

- Use a soft cloth (cotton, flannel, etc.) and gently wipe the surface of the cabinet.
- Using a chemical cloth (wet/dry sheet type cloth, etc.) may deform the components of the main unit cabinet or cause cracking.
- Wiping with a hard cloth or using strong force may scratch the surface of the cabinet.
- If the cabinet is very dirty, wipe with a soft cloth (cotton, flannel, etc.) soaked in neutral detergent diluted with water and thoroughly wrung out, and then wipe with a soft dry cloth.
- Avoid using benzene, thinner, and other solvents, as these may deform the cabinet and cause the paint to peel off.
- Do not apply insecticides or other volatile liquids. Also, do not allow the cabinet to remain in contact with rubber or vinyl products for a long period of time. Plasticizers inside the plastic may cause the cabinet to deform and cause the paint to peel off.

### Caring for the front panel

- Gently wipe the surface of the front panel with a soft cloth (cotton, flannel, etc.). To protect the front panel, do not use a dirty cloth, liquid cleaners, or a chemical cloth (wet/dry sheet type cloth, etc.). This may damage the surface of the front panel.
- Wiping with a hard cloth or using strong force may scratch the surface of the front panel.
- Use a soft damp cloth to gently wipe the front panel when it is really dirty (It may scratch the surface of the front panel when wiped strongly).
- If the front panel is dusty, use an anti-static brush, which is commercially available, to clean it.

### WARNING

To prevent the spread of fire, keep candles or other open flames away from this product at all times.



### 3D glasses (AN-3DG20, sold separately)

#### Prevention of accidental ingestion

- Keep the accessory out of the reach of small children. Small children can accidentally swallow these parts.
  - If a child accidentally swallows any of these parts, seek immediate medical attention.

#### Do not disassemble

- Do not disassemble or modify the 3D glasses.

#### Handling the 3D glasses

- Do not drop, exert pressure on, or step on the 3D glasses. Doing so may damage the glass section, which may result in injury.
- Be careful not to trap your finger in the hinge section of the 3D glasses. Doing so may result in injury.
  - Pay special attention when children are using this product.

#### Using the 3D glasses

- The 3D glasses vision should be limited. Security advisory establishes a maximum of 3 hours visualization, and in any case no more than one show length, break included.
- Use the 3D glasses only for the specified purpose.
- Do not move around while wearing the 3D glasses. The surrounding area appears dark, which may result in falling or other accidents that may cause injury.

### Caring for the 3D glasses

- Use only the cloth provided with the 3D glasses to clean the lenses. Remove dust and soil from the cloth. Any dust or other soiling on the cloth may result in scratches on the product. Do not use solvents such as benzene or thinners as doing so may cause the coating to peel off.
- When cleaning the 3D glasses, take care not to allow water or other fluids to come into contact with the glasses.
- Always store the 3D glasses in the case provided when not in use.
- When storing the 3D glasses, avoid very humid or hot locations.

#### Viewing 3D images

- If you experience dizziness, nausea, or other discomfort while viewing 3D images, discontinue use and rest your eyes.
- Do not use the 3D glasses if they are cracked or broken.

#### Keep away from heat

- Do not place the 3D glasses in a fire, near heat or in an area with high humidity. This product may cause a fire or injury from ignition or explosion of the built-in lithium ion polymer rechargeable battery.

#### Caution regarding rechargeable battery

- Use the supplied USB cable to connect to a USB terminal of a 3D compatible SHARP TV when recharging. Recharging using other devices may lead to battery leakage, heat generation or explosion.

#### Caution regarding the power supply

- Use the supplied USB cable to connect to a USB terminal of a 3D compatible SHARP TV for supplying power. Supplying power using other devices may lead to heat generation or explosion.
- During a thunderstorm, to avoid getting an electric shock, do not use 3D glasses that are power-supplied via USB, and unplug the USB cable from the USB terminal on the TV and the USB terminal on the 3D glasses.

## Introduction

### Supplied accessories

Remote control unit ( x 1)



Pages 6 and 8

Stand unit ( x 1)

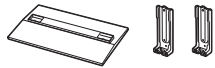

Page 5

Initial setup guide  
(printed document)

USB memory  
(operation manual)

LR03 (“AAA” size alkaline) battery ( x 2)



Page 6

Wireless LAN USB adapter  
(WN8522D 7-JU) ( x 1)

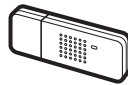

Page 58

Important safety  
precautions  
(printed document)

### Optional accessories

The listed optional accessories are available for this LCD colour TV. Please purchase them at your nearest shop.

- Additional optional accessories may be available in the near future. When purchasing, please read the newest catalogue for compatibility and check the availability.

No.	Part name	Part number	Notes
1	Wall mount bracket	AN-52AG4	<p><b>For 70 inch models</b> The centre of the TV screen is 8 mm below the mark “c” on the wall bracket.</p> <p><b>For 60 inch models</b> The centre of the TV screen is 18 mm below the mark “e” on the wall bracket.</p>
2	3D glasses	AN-3DG20	Refer to the operation manual of the 3D glasses for details regarding usage.

# Preparation

## Attaching the stand unit

- Before attaching (or detaching) the stand, unplug the AC cord.
- Before performing work, spread cushioning over the surface on which you will be laying the TV. This will prevent it from being damaged.

### CAUTION

- **Attach the stand in the correct direction.**
- **Be sure to follow the instructions. Incorrect installation of the stand may result in the TV falling over.**
- **After attaching the stand to the TV, do not hold the stand when you put up, set up, move or lay down the TV.**
- **Do not remove the stand from the TV unless using a wall mount bracket to mount it.**

- 1 Confirm that there are twelve screws (eight long screws and four short screws) supplied with the stand unit.

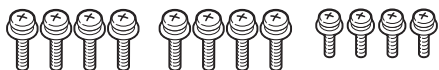

- 2
  - ① Set the supporting post for the stand unit onto the polystyrene foam.
  - ② Attach the stand base to the supporting post.
  - ③ Insert and tighten the eight screws into the eight holes on the bottom of the stand base.
    - Hold the stand unit securely with one hand, and then tighten the screws.

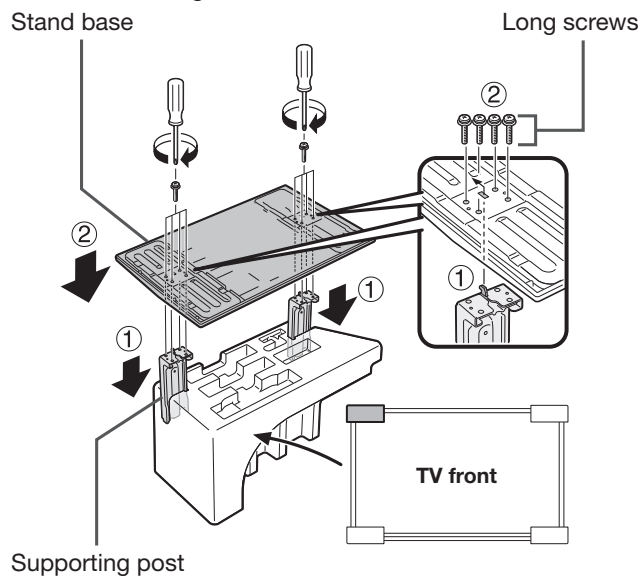

- 3 Insert the stand into the openings on the bottom of the TV (hold the stand so it will not drop from the edge of the base area).
  - Make sure that the stand is firmly inserted into the TV. Improper installation may result in tilting of the TV set.

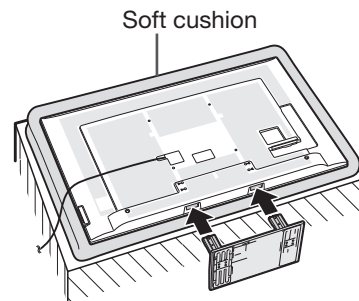

- 4 Insert and tighten the four screws into the four holes on the rear of the TV.

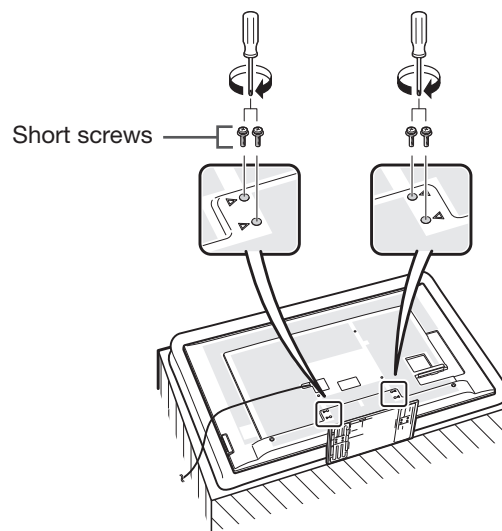

### NOTE

- To detach the stand unit, perform the steps in reverse order.
- A screwdriver is not supplied with this product.
- In the installation procedure, be careful not to catch your fingers between the TV set and the floor.

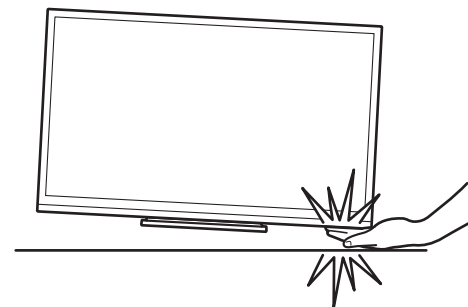

## Preparation

### Using the remote control unit

#### Inserting the batteries

Before using the TV for the first time, insert the two supplied LR03 (“AAA” size alkaline) batteries. When the batteries become depleted and the remote control unit fails to operate, replace the batteries with new LR03 (“AAA” size alkaline) batteries.

- 1 Open the battery cover.
- 2 Insert the two supplied LR03 (“AAA” size alkaline) batteries.
  - Place batteries with their terminals corresponding to the (+) and (–) indications in the battery compartment.
- 3 Close the battery cover.

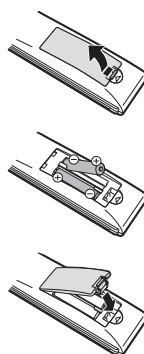

#### CAUTION

Improper use of batteries can result in chemical leakage or explosion. Be sure to follow the instructions below.

- Do not mix batteries of different types. Different types of batteries have different characteristics.
- Do not mix old and new batteries. Mixing old and new batteries can shorten the life of new batteries or cause chemical leakage in old batteries.
- Remove batteries as soon as they have worn out. Chemicals that leak from batteries can cause a rash. If you find any chemical leakage, wipe thoroughly with a cloth.
- The batteries supplied with this product may have a shorter life expectancy due to storage conditions.
- If you will not be using the remote control unit for an extended period of time, remove the batteries from it.
- When replacing the batteries, use alkaline batteries instead of zinc-carbon ones.

#### Note on disposing batteries

The batteries provided contain no harmful materials such as cadmium, lead or mercury.

Regulations concerning used batteries stipulate that batteries may no longer be thrown out with the household rubbish. Deposit any used batteries free of charge into the designated collection containers set up at commercial businesses.

#### Angle of the remote control unit

Use the remote control unit by pointing it towards the remote control sensor. Objects between the remote control unit and sensor may prevent proper operation.

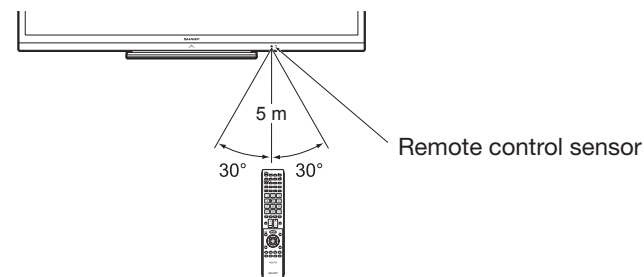

#### Cautions regarding the remote control unit

- Do not expose the remote control unit to shock. In addition, do not expose the remote control unit to liquids, and do not place in an area with high humidity.
- Do not install or place the remote control unit under direct sunlight. The heat may cause deformation of the unit.
- The remote control unit may not work properly if the remote control sensor of the TV is under direct sunlight or strong lighting. In such cases, change the angle of the lighting or the TV, or operate the remote control unit closer to the remote control sensor.

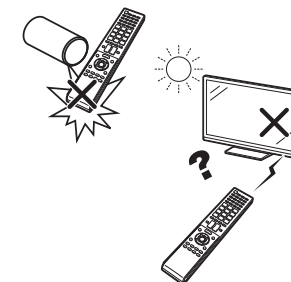



# Part names and functions

## TV (front/side view)

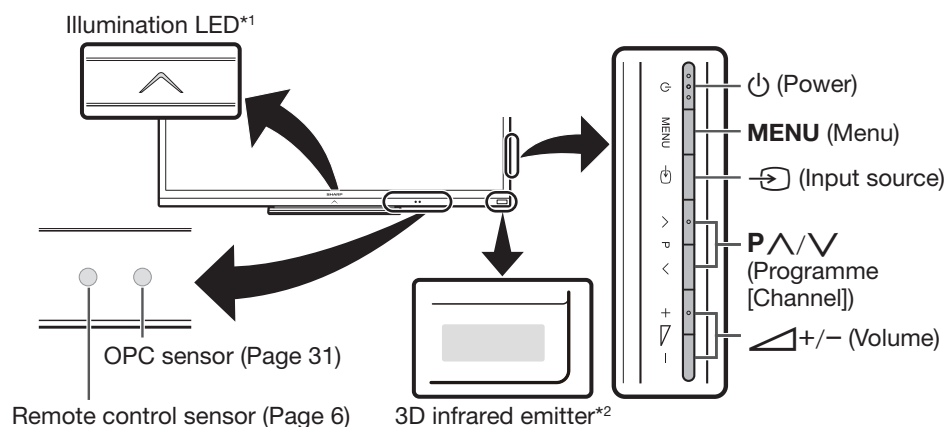

\*1 3D mode: Blue illumination  
2D mode: White illumination

\*2 This panel emits infrared signal towards the 3D glasses you wear when viewing 3D images. Do not place anything between the 3D infrared emitter on the TV and the infrared receiver on the 3D glasses. Refer to page 63 for details.

## TV (rear view)

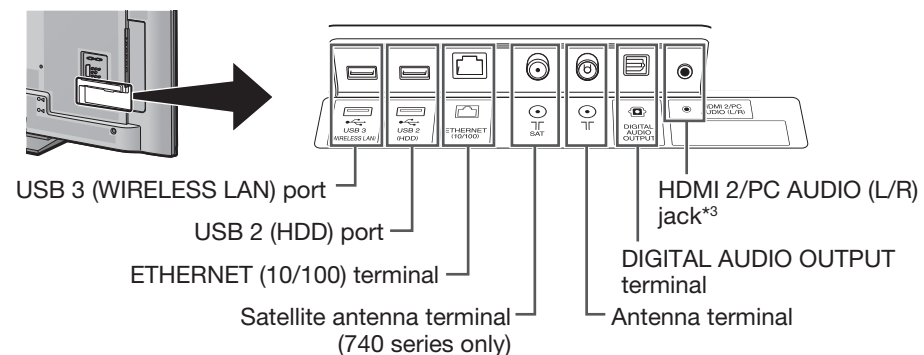

\*3 The HDMI 2 and PC terminals can both use the same audio input terminal (HDMI 2/PC AUDIO (L/R)). However, the proper item must be selected in the "Audio select" menu (refer to page 41 for details).

## TV (rear view) – continued

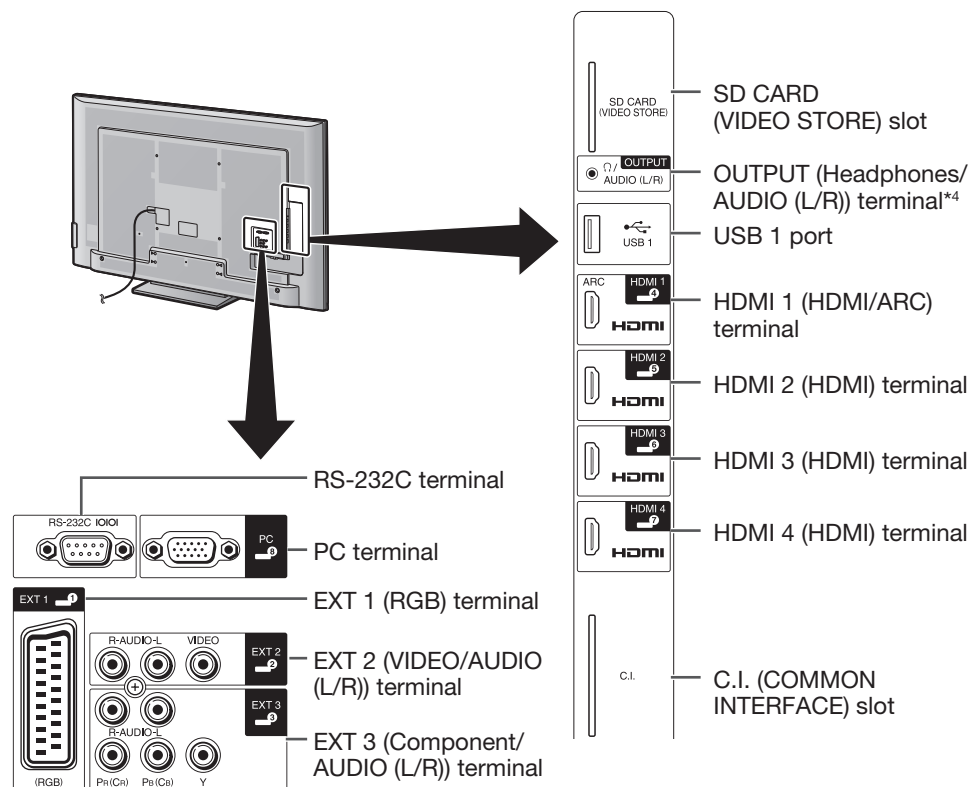

\*4 When the headphone is connected to the OUTPUT terminal, the audio can be output from the speakers (Page 42).

### WARNING

- Excessive sound pressure from earphones and headphones can cause hearing loss.
- Do not set the volume at a high level. Hearing experts advise against extended listening at high volume levels.

### Important information:

Satellite services are only available for the 740 model series.

### Remote control unit

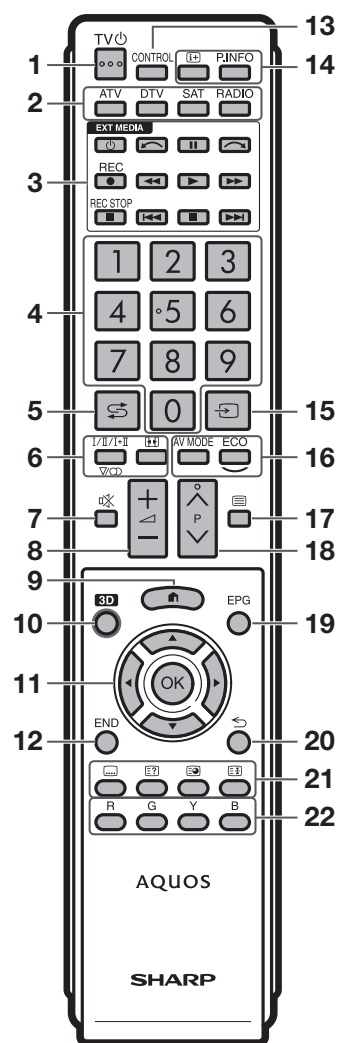

**1 TV (Standby/On) (Page 18)**

**2 ATV**  
Access conventional analogue TV mode.

**DTV**  
Access digital TV mode.

**SAT**  
Access satellite mode.

**RADIO**  
DTV/SAT: Switch between radio and data mode.

- When only data broadcasting (no radio broadcasting) is transmitted by DVB, the radio broadcasting will be skipped.

**3 EXT MEDIA buttons**

EXT MEDIA buttons are used for AQUOS LINK functions and Time shift functions, etc.

- AQUOS LINK (Pages 27–30): Interactively operate compatible system devices using a single remote control unit.
- Time shift + (Pages 44–47): Temporarily record a programme you are watching.

**4 Numeric buttons 0–9**

Set the channel. Enter desired numbers. Set the page in teletext mode.

- When the five Nordic countries (Sweden, Norway, Finland, Denmark or Iceland) are selected in the country setting from initial auto installation (Page 14), DTV services are four digits. When another country is selected, DTV services are three digits.

**5 (Flashback)**

Return to the previously selected channel or external input.

**6 I/II, I+II (Sound mode) (Page 19)**

Select a sound multiplex mode.

**V/CO (Wide mode) (Pages 40, 51 and 52)**  
Select a wide mode.

**7 (Mute)**

TV sound on/off.

**8 +/- (Volume)**

Increase/decrease TV volume.

**9 (HOME)**

Display the “HOME” screen for enjoying Internet connection and Home network functions, as well as performing settings for the TV.

**10 3D (Pages 61–66)**

Select between 3D and 2D image viewing.

**11 (Cursor)**

Select a desired item.

**OK**

Execute a command.

ATV/DTV/SAT: Display “CH list” when no other “Menu” screen is running.

**12 END**

ATV/DTV/SAT: Exit the “Menu” screen. AQUOS NET+: Return to the start page.

**13 CONTROL (Pages 45, 47, 50 and 59)**

Display a panel to operate some functions on the screen.

**14 (i+) (Display information) (Page 19)**

Display the station information (channel number, signal, etc.) on the screen.

**P. INFO**

Display programme information transmitted through digital video broadcasting (DTV/SAT only).

**15 (INPUT) (Page 18)**

Select an input source.

**16 AV MODE (Page 31)**

Select audio/video settings.

**ECO (Standard/Advanced/Off) (Page 34)**

Select “Energy save” setting.

**17 (Teletext) (Page 22)**

ATV: Display analogue teletext. DTV/SAT: Select MHEG-5 or teletext for DTV/SAT.

**18 P^/V**

ATV/DTV/SAT: Select the TV channel. AQUOS NET+: Scrolls pages up/down.

**19 EPG (Pages 20–22)**

DTV/SAT: Display the EPG screen.

**20 (Return)**

ATV/DTV/SAT: Return to the previous screen.

AQUOS NET+: Return to the previous page (This may not function for some services).

**21 Buttons for useful operations**

**(Subtitle) (Pages 22 and 39)**  
Switch subtitle languages on/off.

**(Reveal hidden teletext) (Page 22)**

**(Subpage) (Page 22)**

**(Freeze/Hold) (Page 22)**

Freeze a moving image on the screen. Teletext: Stop updating teletext pages automatically or release the hold mode.

**22 R/G/Y/B (Colour) buttons**

The coloured buttons are correspondingly used to select the coloured items on the screen (e.g., EPG, MHEG-5, teletext).

**Important information:**

Satellite services are only available for the 740 model series.

# Quick guide

## Operation overview

Follow the steps below one by one when using the TV. Some steps may not be necessary depending on your TV installation and connection.

### 1. Preparation – Connecting the TV

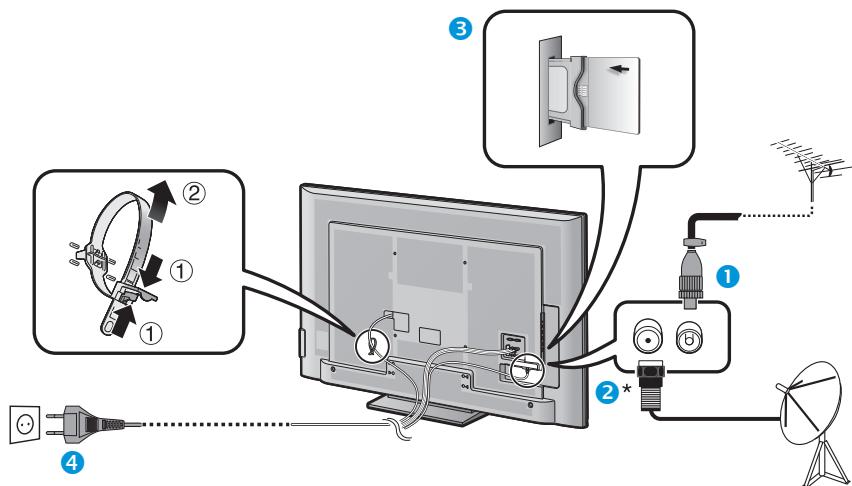

- Place the TV close to the AC outlet, and keep the power plug within reach.
- Product shape varies in some countries.

- 1 Plug the standard DIN45325 plug (IEC 169-2) 75 Ω coaxial cable.
- 2 Connect the satellite antenna cable.
- 3 Insert a CA card into the CI slot to watch scrambled broadcasts (Page 11).
- 4 Plug in the AC cord.

#### \*Important information:

Satellite services are only available for the 740 model series.

### 2. Preparation – Setting the TV

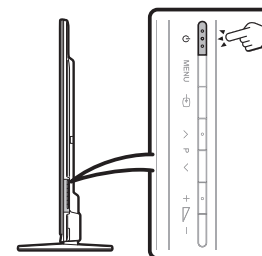

- 1 Press on the TV (Page 18).
- 2 Run the initial auto installation (Page 14).

- Language setting
- Home/Store setting
- Country setting
- PIN setting
- Channel search setting
  - Digital search
    - Terrestrial
    - Cable
  - Analogue search
  - Satellite search



Start searching channels

- 3 **Congratulations!**  
**Now you can watch TV.**
  - If necessary, adjust the antenna to attain maximum signal reception (Page 17).

### 3. Daily operation

#### 1 Turn on/off the TV

(Page 18)

- You can turn on/off the power using both the remote control and the TV.



#### 2 Switch between digital, satellite and analogue broadcast

(Page 18)



#### 3 Change channels

(Page 18)

- You can also select a channel from "HOME" > "CH list".

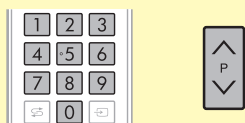

#### 4 Select a programme using EPG

(Pages 20–22)



### 4. Advanced features

#### 1 Use Time shift + function

(Pages 45–47)

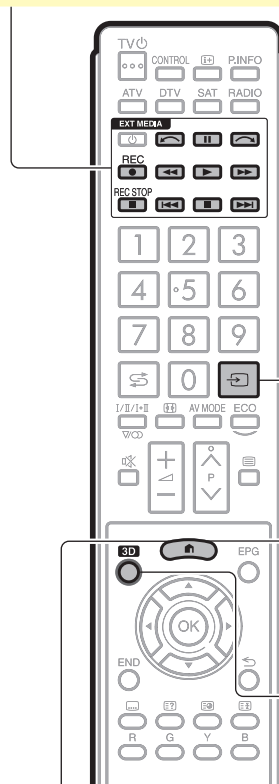

#### 2 Adjust TV settings and enjoy internet service

(Pages 31–43)

- You can launch Internet connection and Home network functions, as well as perform settings for the TV from the "HOME" screen.



### 5. Enjoy additional features

#### 1 Connect external devices

Connection overview  
(Pages 23–28)

- Be sure to turn off the TV and any devices before making any connections.



Switch input sources  
(Page 18)

#### 2 Enjoy photos, music and video stored in USB media/Home network

(Pages 48–51)



#### 3 Display a PC image on the TV screen

(Pages 52–56)



#### 4 Enjoy internet service\* with the TV

(Pages 12 and 57–60)

\* The following service is now available:

- YouTube™ (Page 12)
- Net TV (Pages 59–60)



#### 5 Watch 3D images

(Pages 61–66)

- Some menu items are greyed out in 3D mode. This is not a malfunction.



### Inserting the CA card into the CI module

In order to receive coded digital stations, a common interface module (CI module) and a CA card must be inserted in the CI slot of the TV.

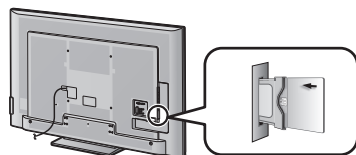

- 1 Carefully insert the CI module in the CI slot with the contact side forward.
- 2 The logo on the CI module must be facing outward from the rear of the TV.

#### Checking CI module information

Go to "HOME" > "TV Menu" > "Setup" > "Option" > "CI menu".

- This menu is only available for digital stations.
- The content of this menu depends on the provider of the CI module.

#### Module

General information on CI module displays.

#### Menu

Adjustment parameters of each CA card displays.

#### Enquiry

You can input numerical values such as passwords here.

#### NOTE

- It takes a few minutes to certify the licence key when you insert a CA card into the CI+ compatible CI module for the first time. This process may fail when there is no antenna input or you have never run "Auto installation".
- The CI+ compatible CI module sometimes upgrades its firmware. You may not receive any TV images before upgrading. You can only use the power button during upgrading.
- Copy protected content may not be output or may be output with a copy control signal. The protect icon\* is displayed when **P.INFO** is pressed while watching copy protected contents.
- \* Protect icon: 
- If the TV displays an update confirmation message for the CA card while receiving CI+ compatible broadcasts, follow the screen prompts.
- Make sure that the CI module is properly inserted.

## Quick guide

### Using the HOME screen

You can easily launch this “HOME” screen to enjoy Internet connection and Home network functions and to perform settings for the TV.

#### LCFONT

This product is embedded with LC Font technology, which was developed by SHARP Corporation for clearly displaying easy-to-read characters on LCD screens.

### Basic operation

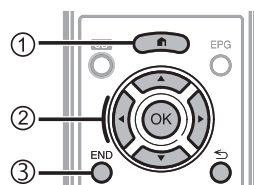

#### ① Display the HOME screen

Press **HOME** and the “HOME” screen will be displayed.

#### ② Select an item

Press **▲/▼/◀/▶** to select the desired service or menu, and then press **OK**.

→ See the right column for details on the operations in the “HOME” screen.





#### ③ Exit the HOME screen

The operation will exit the “HOME” screen if you press **END** before it is completed.

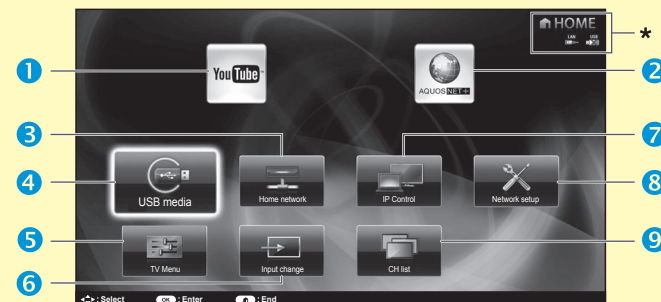
#### Tips:

#### HOME menu contents



- \* When “” is displayed, the USB device for the “USB media” menu is not detected. If “” is displayed, check your USB device connection.
- \* When “” is displayed, you cannot connect to your TV network. If “” is displayed, check your TV network settings and connection.
- \* When “” is displayed, the USB device for the “Time shift” is registered.

- |   |                                      |
|---|--------------------------------------|
| <b>1 YouTube™</b><br>You can enjoy YouTube on your AQUOS.   | <b>6 Input change</b>                |
| <b>2 AQUOS NET+</b> (Pages 59–60)<br>You can connect to the internet through AQUOS NET+.  | <b>7 IP Control</b> (Page 55)        |
| <b>3 Home network</b> (Pages 48–50)   | <b>8 Network setup</b> (Pages 57–58) |
| <b>4 USB media</b> (Pages 48–50)  | <b>9 CH list</b>                     |
| <b>5 TV Menu</b> (Page 13)<br>Call up the OSD to perform settings for the TV. The OSD for the settings is called “TV Menu”. The “TV Menu” enables various settings and adjustments. |                                      |

#### Regarding the instructions in the manual

In this manual, the following expression is often used in order to simplify instructions.

- Go to “HOME” > “TV Menu” > “Setup” > ...

This indicates how to navigate through the HOME screen using the **▲/▼/◀/▶** and **OK** buttons.

## Quick guide

### Using the Menu screen

You need to call up the OSD to perform settings for the TV. The OSD for the settings is called "Menu". The "Menu" enables various settings and adjustments.

#### Display the Menu screen

- Go to "HOME" > "TV Menu".
  - You can also display the Menu screen with pressing the **MENU** button on the side of the TV.

#### Selecting in the Menu

- Press ◀/▶ to select the desired menu, and then press **OK**. Press ⏪ to return to the previous menu category.
- Press ◀/▶ to select the desired sub-menu, and then press **OK**.
- Press ▲/▼ to select the item you want to select/adjust, and then press **OK**.

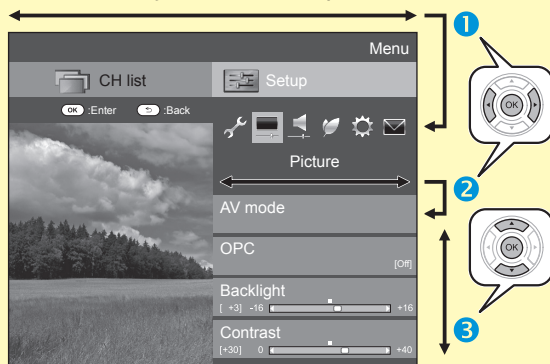

#### Selecting options

- Press ▲/▼ or ◀/▶ to configure the control for improving TV viewing, and then press **OK**.

#### EXAMPLE

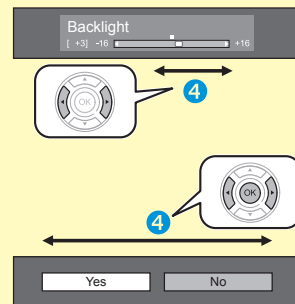

#### NOTE

- Refer to the guide display below the menu bar to see when to press the **OK** button.



#### About the guide display

The guide display below the menu bar shows operations for the OSD.

- The bar above is an operational guide for the remote control unit. The bar will change in accordance with each menu setting screen.

#### NOTE

- "Menu" options differ according to the selected input modes, but the operating procedures are the same.
- Items with Ⓞ cannot be selected for various reasons.
- Some items cannot be selected depending on signal types, optional settings or connected devices.

### Using Software keyboard

Use the software keyboard when you need to input text.

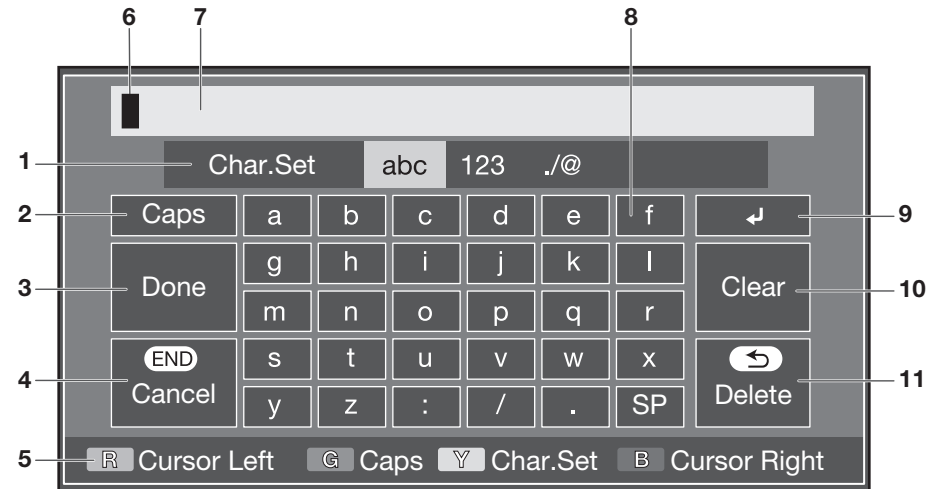

- Char. Set**  
Changes character set into the alphabet, numbers, symbols, etc.
- Caps**  
Changes characters to capital/lower case.
- Done**  
Confirm the entry.
- Cancel**  
Abort input and close the software keyboard.
- R/G/Y/B (Colour) buttons**  
Selects the coloured items on the screen.
- Input cursor**  
Press ◀/▶ to move the cursor when highlighted.
- Input field**  
The text you enter is displayed as you type it in.
- Character**  
Input characters by using these buttons.
- Clear**  
Erases the character string.
  - When the cursor is somewhere in a line: The character string to the right of the cursor will be erased.
  - When the cursor is at the right end of a line: The entire line will be erased.
- Delete**  
If the cursor is at the right end of a line, this erases text one character at a time.
  - You can also delete text by pressing ⏪ on the remote control unit.
- Line break**  
Put a line break.

#### NOTE

- Depending on the application, there may be a different software keyboard than the one indicated above.

# Initial auto installation

## Initial auto installation





When the TV is powered on for the first time after purchase, the initial auto installation wizard appears. Follow the menus and make the necessary settings one after another.

### Confirm the following before turning on the power



- Is the antenna cable connected?
- Is the AC cord plugged in?



### Important information:





Satellite services are only available for the 740 model series.

- 1 Press  on the TV.
  - The initial auto installation wizard appears.
- 2 Setting the OSD language.  
Press /// to select the desired language, and then press **OK**.
- 3 Selecting the location of the TV.



Press / to select where you will use this TV, and then press **OK**.



- The confirmation screen pops up only when selecting “STORE”. Press / to select “Yes” or “No”.
- HOME: “STANDARD” will be the default value for the “AV mode” setting.
- STORE: “DYNAMIC (Fixed)” will be the default value for the “AV mode” setting. If the “AV mode” is changed, the TV will automatically switch back to “DYNAMIC (Fixed)” when there is no operation using the TV or remote control unit for 30 minutes.
- STORE: A demonstration image will be displayed after initial auto installation is completed. If you have chosen “STORE” by mistake, go to “HOME” > “TV Menu” > “Setup” > “View setting” > “Reset” > select “HOME” again.

- 4 Setting the country.  
Press /// to select your country or area, and then press **OK**.
  - This setting screen only appears during the initial auto installation.

### NOTE

- Some functions may not display or be selectable depending on the country setting or cable provider selection.

- 5 Setting the PIN.

- ① Press / to select “Yes”, and then press **OK**.
  - When “No” is selected, the PIN code setting is skipped.
- ② Enter a four-digit number as a PIN using the 0–9 buttons.
- ③ Enter the same four-digit number as in step ② to confirm.
- ④ Press **OK**.

### NOTE

- When “France” is selected in the country setting, the PIN code setting cannot be skipped.
- “0000” cannot be set as the PIN code.
- When the PIN code setting is skipped, the default PIN code (“1234”) will automatically be set.
- To change the PIN setting, refer to **Individual setting – PIN** (Page 38). To reset the PIN setting (PIN input will no longer be needed), refer to **Reset the PIN** (Page 67).

- 6 Starting channel search.

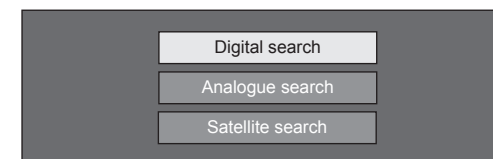

Press / to select “Digital search”, “Analogue search” or “Satellite search”, and then press **OK**.

- (740 series only) After performing “Digital search” or “Analogue search”, the screen switches to the “Satellite search” setting. You should then execute “Yes” if you want to search for satellite channels.
- To watch both digital broadcasts and analogue broadcasts, you should perform “Digital search” or “Analogue search” from “Auto installation” under the “Setup” menu (Page 35).
- When you select “Satellite search”, only satellite broadcasts will be searched.
- If you want to search for more broadcasts, execute “Additional search” from the “Programme setup” menu (Pages 35–37).

### NOTE

- If you turn off the power on the TV while performing a channel search, the initial auto installation wizard will not appear. The auto installation function allows you to execute the installation again from “HOME” > “TV Menu” > “Setup” > “View setting” (Page 35).
- The initial auto installation wizard will abort if you leave the TV unattended for 30 minutes before searching for channels.
- When “Italy” or “France” is selected in the country setting, the default age restriction value is set to 18.



## Initial auto installation

### Digital broadcast setting

Press ◀/▶ to select “Terrestrial” or “Cable”, and then press **OK**.



#### ● Searching for terrestrial broadcasts

The TV searches for, sorts and stores all the receivable TV stations according to their settings and the connected antenna.

- To abort the initial auto installation in progress, press ↵.

#### NOTE

- A region or service selection screen may display depending on the country settings or cable providers selections. Follow the screen prompts to make the selections.



#### 740 series only

After searching for terrestrial channels, the screen switches to the “Satellite search” setting (Page 16).

#### ● Searching for cable broadcasts

To change each item to the appropriate settings:

- Press ▲/▼ to select the menu, and then press **OK**.
- Press ▲/▼/◀/▶ or 0–9 to select or input the appropriate item/value, and then press **OK**.

Scrambled stations	[Yes]
Search method	[Channel]
Start frequency	[47.0]
Network ID	[None]
Symbol rate 1	[6875]
Symbol rate 2	[6900]
QAM modulation 1	[64]
QAM modulation 2	[256]
Reset	
Search start	

- Press ▲/▼ to select “Search start”, and then press **OK**.
- Press ◀/▶ to select “Yes” to start searching cable broadcasts, and then press **OK**.
- The TV searches for, sorts and stores all the receivable TV stations according to their settings and the connected antenna.
  - To abort the initial auto installation in progress, press ↵.



#### 740 series only

After searching for cable channels, the screen switches to the “Satellite search” setting (Page 16).

Menu	Description	Selectable items
<b>Scrambled stations</b>	Specifies if you need to add pay-TV services.	Yes, No
<b>Search method</b>	Specifies how you search for channels.*2	Channel, Frequency, Quick
<b>Start frequency</b>		From 47.0–858.0 MHz
<b>Network ID</b>	Specifies the network.*3	None, 0–65535
<b>Symbol rate 1/ Symbol rate 2*1</b>	Input the value received for CATV.*4	1000–9000
<b>QAM modulation 1</b>		16, 32, 64, 128, 256
<b>QAM modulation 2</b>		None, 16, 32, 64, 128, 256

- \*1 Set up “Symbol rate 2” if the cable provider uses several symbol rates.
- \*2 Details about the “Search method” items are as follows:
  - Channel: Extracts all information from a channel (quick, but needs corresponding TV stations).
  - Frequency: Checks every frequency in range (slow).
  - Quick: All services are searched by one frequency. This menu works only when your cable provider provides the frequency and the network ID (e.g., Homing channel). When “Quick” is selected, “Scrambled stations” is automatically set to “No”, and “None” for the “Network ID” menu cannot be selected.
- \*3 Set this to register only the specified network ID without registering any special services.
- \*4 The symbol rates are specified by the cable provider.

### Analogue broadcast setting

The TV searches for, sorts and stores all the receivable TV stations according to their settings and the connected antenna.

- To abort the initial auto installation in progress, press ↵.



#### 740 series only

After searching for analogue channels, the screen switches to the “Satellite search” setting (Page 16).

### Searching for satellite broadcasts (740 series only)

Press ▲/▼ to select “Satellite search”, and then press **OK**.

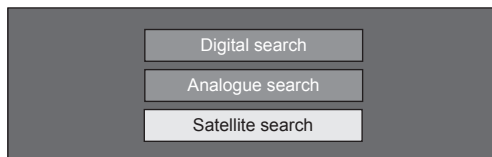

- The antenna connection setting screen is displayed.

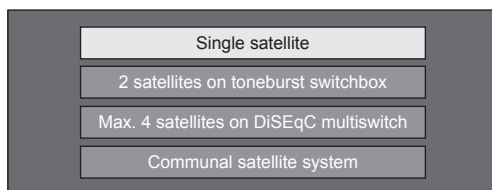

#### NOTE

- You can select the antenna connection method from the four types. Consult your dealers before using a method other than “Single satellite”.

### ● “Single satellite” setting

- 1 Press ▲/▼ to select “Single satellite”, and then press **OK**.
- 2 Press ▲/▼/◀/▶ to select your favorite satellite, and then press **OK**.

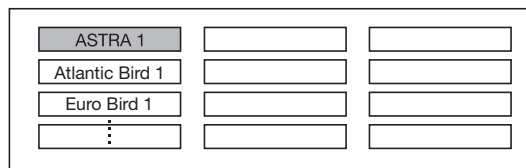

#### NOTE

- Follow the instructions on the screen for “2 satellites on toneburst switchbox”, “Max. 4 satellites on DiSEqC multiswitch” and “Communal satellite system” settings.
- To set multiple satellite channels, go to “Max. 4 satellites on DiSEqC multiswitch”.
- When a power supply is needed for your satellite antenna, follow the procedure below in order to supply the voltage specified by your service provider, etc.: Go to “HOME” > “TV Menu” > “Setup” > “View setting” > “Channel settings” > “Antenna setup-DIGITAL” > “Satellite setup” > “Change setting” > “Communal satellite system”.

### ● Search start:

DVB-S/S2 channel searching.

- 1 Press ◀/▶ to select “Yes”, and then press **OK**.
  - To change the settings for “Scrambled stations” or “Symbol rate”, press ▲/▼ to select the item to be reconfigured and then perform “Search start”.

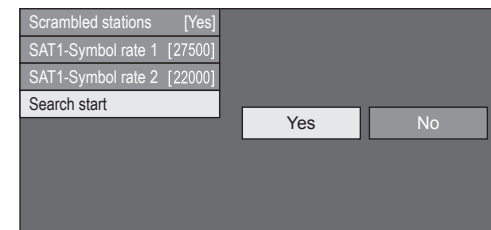

- 2 The TV searches for and stores all the receivable TV stations according to their settings and the connected antenna.
  - Select “Yes” to sort the search result in alphabetical order.
  - To abort the initial auto installation in progress, press ⏪.

#### NOTE

- Scrambled stations: Specifies if you need to choose pay-TV services.
- Follow the procedure to perform “Manual search” if you want to configure the frequency or symbol rate and start to search after performing the auto searching during the initial auto installation.
  - Go to “HOME” > “TV Menu” > “Setup” > “View setting” > “Channel settings” > “Programme setup” > “Satellite setting” > “Manual search”.
  - Symbol rate: You need to set each symbol rate of all the satellite broadcasts that the TV can receive (eight is the maximum number of symbol rates that can be displayed).



# Watching TV

## Daily operation

### Turning on/standby the power

#### Turning on the power

Press on the TV or **TV** on the remote control unit.

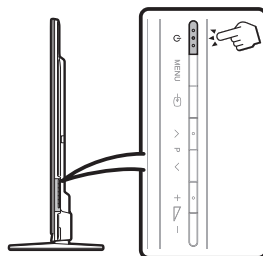

#### Standby mode

Press on the TV or **TV** on the remote control unit when TV is on.

- The TV enters standby mode and the image on the screen disappears.
- Weak electric power is still consumed even when the TV is turned standby mode.
- To completely turn off the power to the TV, unplug the AC cord from the AC outlet. However, do not unplug the AC cord unless otherwise instructed.

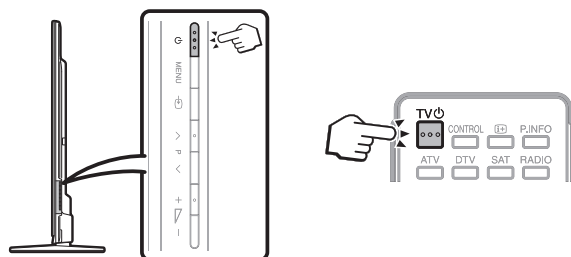

#### NOTE

- If you are not going to use this TV for a long period of time, be sure to remove the AC cord from the AC outlet.

## Switching between digital, satellite\* and analogue broadcasts

### Watching digital broadcasts



### Watching analogue broadcasts

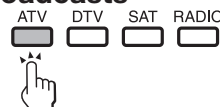

### Watching satellite broadcasts



#### \*Important information:

Satellite services are only available for the 740 model series.

#### NOTE

- If multiple satellite services are set, each time you press the **SAT** button the channel switches as follows.

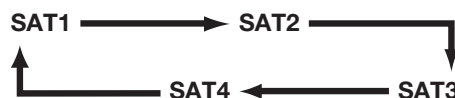

## Changing channels

With **P**



With **0-9**



## Selecting an external video source

Once the connection is made, press to display the "INPUT" screen, and then press or / to switch over to the appropriate external source with **OK**.

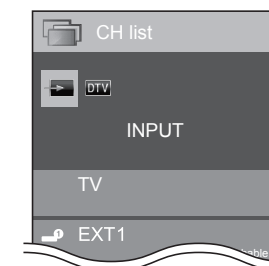

#### NOTE

- You can also select an external video source from "HOME" > "Input change".
- Only HDMI inputs which are not set for "Input skip" (Page 41) and properly connected inputs can be selected.

## Watching TV

### Selecting a sound mode

#### ● DTV/SAT mode

If multi sound modes are received, each time you press  $\frac{I/II}{\sqrt{O}}$  the mode switches as follows.

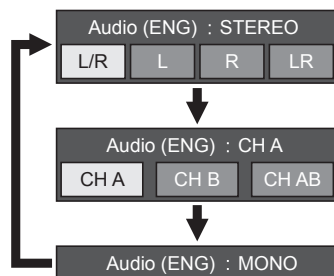

Press  $\leftarrow/\rightarrow$  to select L or R sound when the STEREO or DUAL MONO screen is displayed.

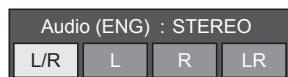

#### NOTE

- The sound mode screen disappears in six seconds.
- Selectable items vary depending on the received broadcasts.
- When the “Audio description setting” menu is set to “On”, the audio description sound is selected depending on the main audio.

#### ● ATV mode

Each time you press  $\frac{I/II}{\sqrt{O}}$ , the mode switches as shown in the following tables.

NICAM TV broadcasts selection	
Signal	Selectable items
Stereo	NICAM STEREO, MONO
Bilingual	NICAM CH A, NICAM CH B, NICAM CH AB, MONO
Monaural	NICAM MONO, MONO

A2 TV broadcasts selection	
Signal	Selectable items
Stereo	STEREO, MONO
Bilingual	CH A, CH B, CH AB
Monaural	MONO

#### NOTE

- When no signal is input, the sound mode will display “MONO”.

### Channel display

You can display the channel information by pressing  $\text{i+}$  on the remote control unit.

#### DTV mode

BBC ONE	
DTV	004
TV	
Audio (ENG) :	STEREO
Video	576i
Subtitle	Off
>> New information	

#### ATV mode

BBC1	
ATV	04
Auto	B/G
	MONO
Subtitle	-

- \*1 Four digit numbers (e.g., 0001) are displayed after selecting the five Nordic countries in the country setting.

#### SAT mode

BBC ONE	
SAT1	0001
TV	
Audio (ENG) :	STEREO
Video	576i
Subtitle	Off
>> New information	

- \*2 Satellite channels are displayed by four digit numbers (e.g., 0001).

- \*3 You can set four satellite stations to “SAT1”, “SAT2”, “SAT3”, “SAT4”.

#### ● Time display in channel information

You can display the time information included in DTV, SAT and teletext broadcasts.

#### NOTE

- Skip step 1 if receiving DTV/SAT broadcasts.
- 1 Select a TV channel (the time information is automatically captured).
  - 2 Press  $\text{i+}$ . The channel display will appear on the TV.
  - 3 Press  $\text{i+}$  again within the several seconds that the channel display is on the screen. Time information will be shown in the lower-right corner of the screen for several seconds.
  - 4 Even when you change the TV channel, you can display the time information with steps 2 and 3 above.

### Operation without a remote control unit

You can operate the menu settings using the TV control buttons.

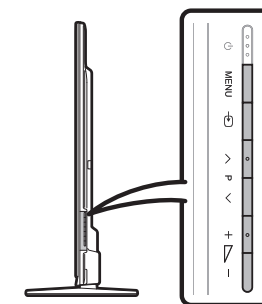

TV control buttons	Remote control buttons
MENU	-
$\text{P} \rightarrow$	OK
$\text{P} \wedge / \vee$	$\blacktriangle / \blacktriangledown$
$\triangleleft / \triangleright$	$\blacktriangleright / \blacktriangleleft$

### EPG

EPG is a programme list that is displayed on the screen. With the EPG, you can check the schedule for DTV/SAT/RADIO/DATA, view detailed information about them and tune to an event currently on-air.

#### Useful settings for using EPG

##### View setting EPG

If you want to use the EPG for digital stations, select “Yes”. The EPG data must be automatically captured while the TV is in standby mode. After setting to “Yes”, it may take some time to turn off the power using the remote control unit or the TV due to the data capture process.

Go to “HOME” > “TV Menu” > “Setup” > “View setting” > “Individual setting” > “Standby search” > “EPG”.

##### Option Display range setup

The “Display range setup” allows you to select three types of time spans for display on the screen.

Go to “HOME” > “TV Menu” > “Setup” > “Option” > “EPG setup” > “Display range setup”.











Item	
<b>Mode 1 (Wide angle)</b>	Displays six hours of programme information.
<b>Mode 2 (Zoom)</b>	Displays three hours of programme information.
<b>Mode 3 (Vertical angle)</b>	Changes to the EPG display format with a vertical time span.

##### Option Genre icon setup

You can grey out or place a mark on desired genres and smoothly search for programmes you frequently watch.

- 1 Go to “HOME” > “TV Menu” > “Setup” > “Option” > “EPG setup” > “Genre icon setup”.
- 2 Press ▲/▼ to select the desired genre, and then press **OK**.

##### ● Genre icon list

Icon	Genre	Icon	Genre
	Movie/Drama		Music/Ballet/Dance
	News/Current affairs		Arts/Culture (without music)
	Show/Game show		Social/Political issues/Economics
	Sports		Education/Science/Factual topics
	Children's/Youth programmes		Leisure hobbies

- 3 Press ▲/▼ to select a level to pick out or search for programmes you want to watch (“Standard”, “Light”, “Remark”).

## Watching TV

### Selecting a programme using EPG

The illustrations on this page are explained using three digit services.

#### Display/Close the EPG screen

Press **EPG**.

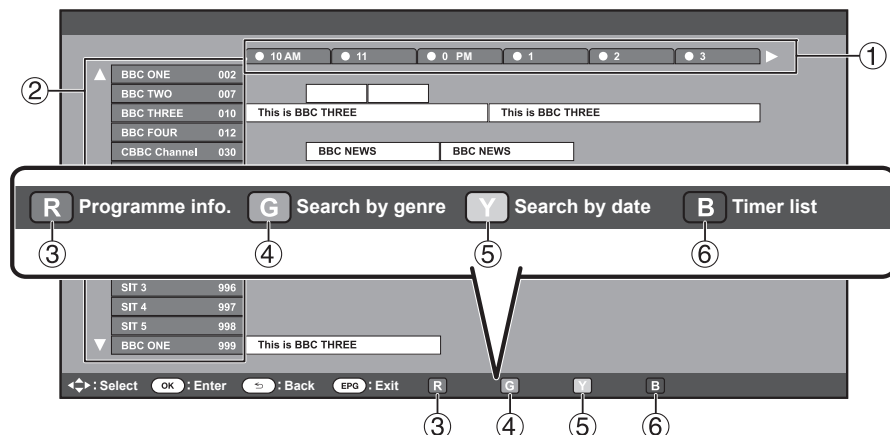

#### NOTE

- You can also display the EPG screen from "HOME" > "TV Menu" > "EPG" > "EPG".

#### Select a programme

##### ① Select the time span

Press **◀/▶** to select the time span you want to search.

- Continue to press **▶** to display programmes in the next time span.

##### ② Select the desired programme

Press **▲/▼** to select the desired programme.

- If **▲** or **▼** are displayed on the left of the services, continue to press **▲/▼** to display next or previous screen.

##### ③ Check programme information



- Press **▲/▼/◀/▶** to select the programme you want to check.
- Press **R**, and then press **OK** to tune to the selected programme.

##### ④ Search a programme in a category



- Press **G**.
- Press **▲/▼** to select the desired genre, and then press **OK**.
- Press **▲/▼** to select a programme you want to watch, and then press **OK**.
  - Refer to page 20 for the genre setting.

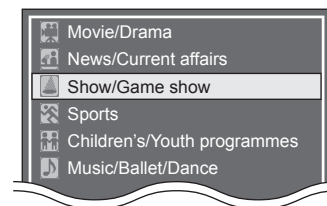

#### NOTE

- You can also display this setting screen from "HOME" > "TV Menu" > "EPG" > "Search by genre".

##### ⑤ Search for a programme by date/time



- Press **Y**.
- Press **◀/▶** to select the desired time span, and then press **OK**.

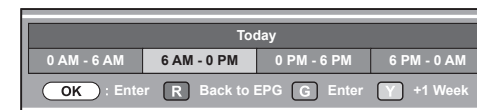

- Press **▲/▼** to select the desired programme, and then press **OK**.

#### NOTE

- You can also display this setting screen from "HOME" > "TV Menu" > "EPG" > "Search by date".

##### ⑥ Display the timer list for TV programmes



- Press **B**.
- Refer to page 22 for the timer setup.

## Watching TV

### Timer setup using EPG

The TV can be switched to a programme or start recording for time shift at the set time.

- 1 Press **EPG**.
- 2 Press **▲/▼/◀/▶** to select the programme you want to set, and then press **OK**.

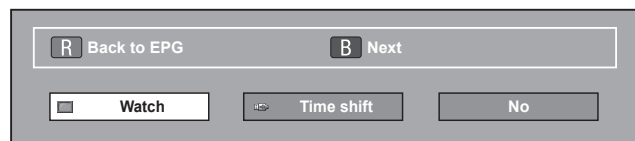

- 3 Press **◀/▶** to select “Watch” or “Time shift”, and then press **OK**.
  - If you select “No”, the TV returns to the EPG screen.
- 4 Press **◀/▶** to select “Yes”, and then press **OK**.
  - The selected TV programme is marked with an icon.
- 5 Press **OK** to select “Back”.

#### NOTE

- You cannot select “Time shift” when the registered USB storage device is not connected to the USB port.
- Only one time shift timer setting can be set.
- A combined total of 16 timer settings (“Watch” and “Time shift”) can be set.

### Cancelling the timer setup

- 1 Press **EPG**.
- 2 Press **▲/▼/◀/▶** to select the programme with timer setup, and then press **OK**.
- 3 Press **◀/▶** to select “Cancel”, and then press **OK**.
- 4 Press **◀/▶** to select “Yes”, and then press **OK**.

#### ● Cancelling using B button on the remote control unit

- 1 Press **EPG**.
- 2 Press **B** to display the timer setup list.
- 3 Press **▲/▼** to select the programme you want to cancel timer setup, and then press **OK**.
- 4 Press **◀/▶** to select “Cancel”, and then press **OK**.
- 5 Press **◀/▶** to select “Yes”, and then press **OK**.

## Teletext

### What is teletext?

Teletext broadcasts pages of information and entertainment to specially equipped TV. Your TV receives teletext signals broadcast by a TV network, and decodes them into graphical format for viewing. News, weather and sports information, stock exchange prices and programme previews are among the many services available.

### Turning teletext on/off

- 1 Select a TV channel or external source providing a teletext programme.
- 2 Press **≡** to display the teletext.
  - Many stations use the TOP operating system, while some use FLOF (e.g., CNN). Your TV supports both these systems. The pages are divided into topic groups and topics. After switching on the teletext, up to 2,000 pages are stored for fast access.
  - If you select a programme with no teletext signal, “No Teletext available” displays.
  - The same message displays during other modes if no teletext signal is available.



- Each time you press **≡**, the screen switches as shown above.
- Press **≡** again to display the teletext on the right screen and the normal image on the left screen.

#### NOTE

- Teletext will not work if the selected signal type is RGB (Page 41).
- Teletext will not work in 3D mode.

### Buttons for teletext operations

Buttons	Description
<b>P▲/▼</b>	Increase or decrease the page number.
<b>Numeric buttons 0–9</b>	Directly select any page from 100 to 899 by using the <b>0–9</b> numeric buttons.

<b>Colour (R/G/Y/B)</b>	Select a group or block of pages displayed in the coloured brackets at the bottom of the screen by pressing the corresponding colour <b>(R/G/Y/B)</b> on the remote control unit.
<b>ⓘ (Reveal hidden teletext)</b>	Reveal or hide hidden information such as an answer to a quiz.
<b>⏸ (Freeze/Hold)</b>	Stop updating teletext pages automatically or release the hold mode.
<b>⋮ (Subtitle for teletext)</b>	Display the subtitle or exit the subtitle screen. <ul style="list-style-type: none"> <li>• Subtitles will not be displayed when the service does not contain subtitle information.</li> </ul>
<b>⏪ (Subpage)</b>	Reveal or hide subpages. <ul style="list-style-type: none"> <li>• Move to the previous subpage <b>(R)</b>.</li> <li>• Move to the following subpage <b>(G)</b>.</li> <li>• These two buttons are shown on the screen by the symbols “+” and “-”.</li> </ul>
<b>OK</b>	Display the top menu. <ul style="list-style-type: none"> <li>• The top menu will not be displayed when the service does not support top menus.</li> </ul>

### MHEG-5 application (UK only)

Some services bring you programmes with the MHEG application encoded, letting you experience DTV interactively. When provided, the MHEG-5 application will start when you press **≡**.

#### NOTE

- MHEG may not be displayed properly in 3D mode.

#### NOTE (741 series only)

- You can view some MHEG-5 content even if you do not perform “Network setup”. Furthermore, “Network setup” allows you to view additional content such as interactive content from “HOME” > “TV Menu” > “Setup” > “View setting” > “Network setup”.
- You cannot view MHEG-5 content when MHEG-5 content is not broadcast even if you perform the appropriate “Network setup”. Carefully check the broadcast programme.



# Connecting external devices

## Introduction to connections

The TV is equipped with the terminals as shown below. Find the cable corresponding to the TV's terminal and connect the device.

### ● Before connecting ...

- Be sure to turn off the TV and any devices before making any connections.
- Firmly connect a cable to a terminal or terminals.
- Carefully read the operation manual of each external device for possible connection types. This also helps you get the best possible audiovisual quality to maximise the potential of the TV and the connected device.

### Connection method for other devices

#### ■ PC

→ Page 52



#### ■ USB device

→ Page 44



#### ■ Internet

→ Pages 57 and 58

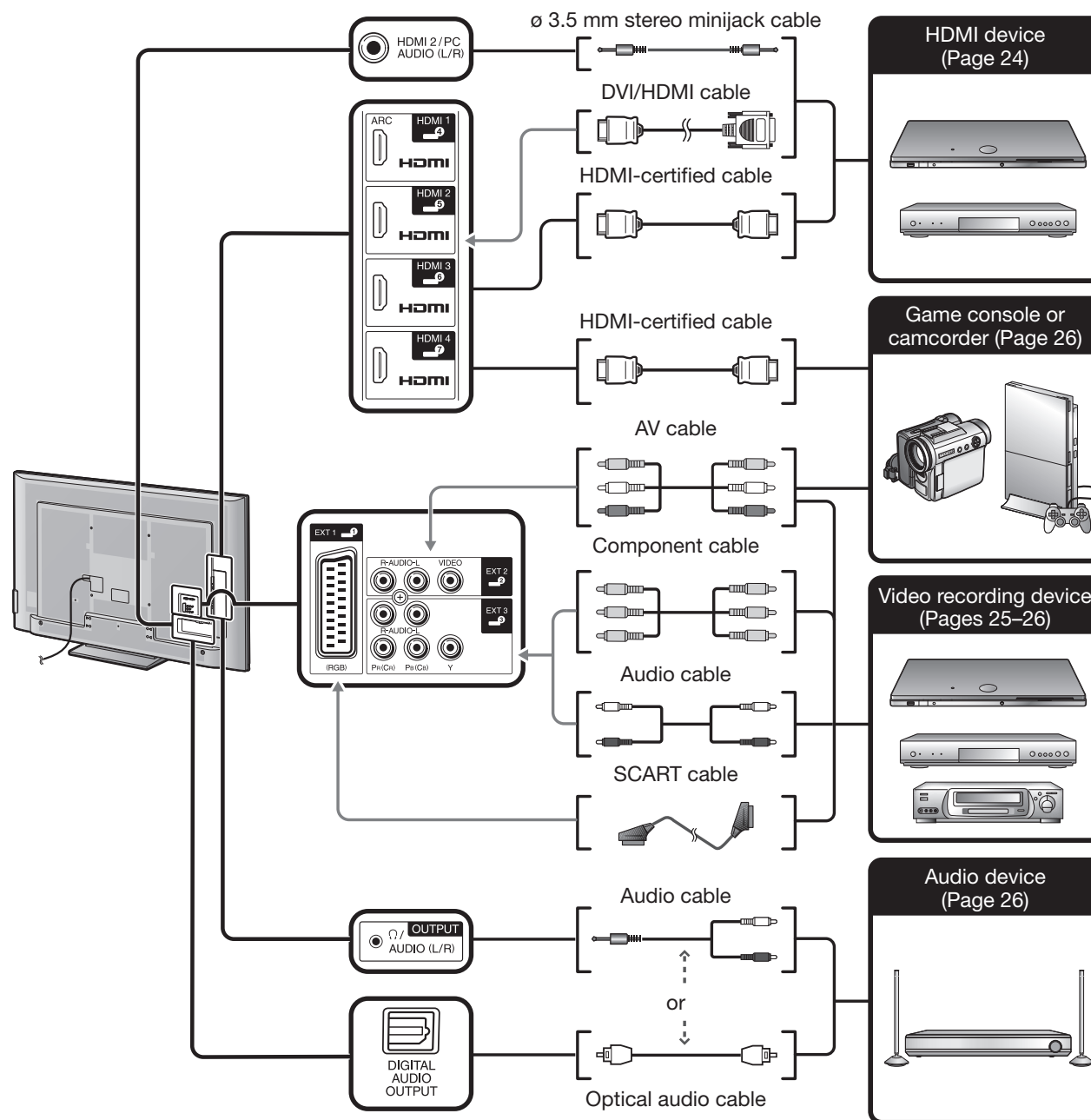

## Connecting external devices

### Video connections

#### HDMI connection

##### Example of connectable devices

- DVD player/recorder
- Blu-ray player/recorder
- Game console

The HDMI connections permit digital video and audio transmission via a connection cable from a player/recorder. The digital picture and sound data are transmitted without data compression and therefore lose none of their quality. Analogue/digital conversion is no longer necessary in the connected devices, which also would result in quality losses.

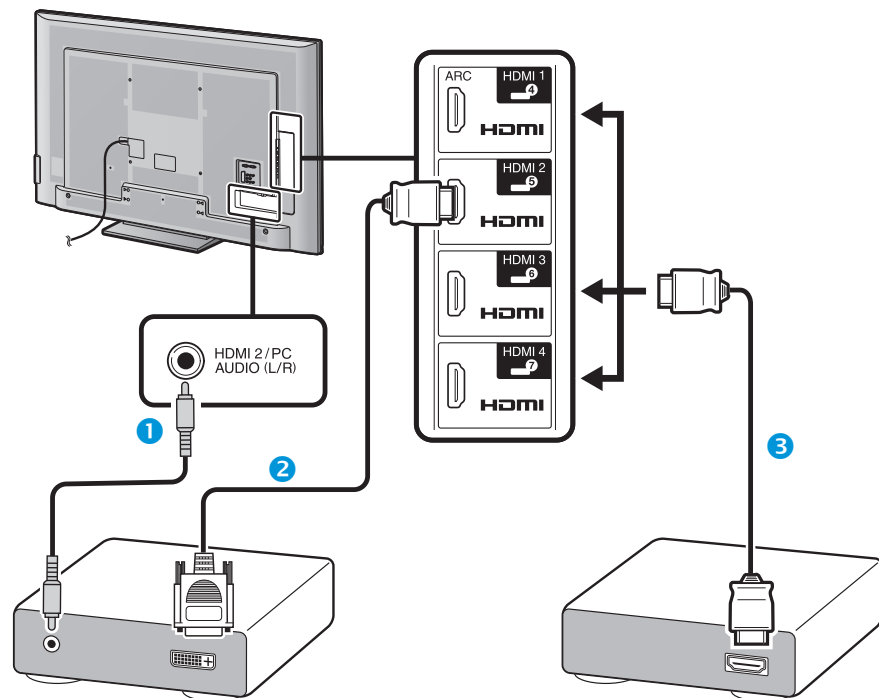

- 1 ø 3.5 mm stereo minijack cable (commercially available)
- 2 DVI/HDMI cable (commercially available)
- 3 HDMI-certified cable (commercially available)

#### DVI/HDMI conversion

Using a DVI/HDMI cable, the digital video signals of a DVD can also be played via the compatible HDMI connection. The sound must be fed in additionally.

- When connecting a DVI/HDMI cable to the HDMI terminal, the image may not come in clearly.
- Both HDMI and DVI use the same HDCP copy protection method.

#### ● When using the HDMI 2 terminal

You must set the audio signal input source depending on the type of HDMI cable connected (refer to page 41 for details).

##### HDMI-certified cable

- 1 Press to select "HDMI 2" from the "INPUT" menu, and then press **OK**.
- 2 Go to "HOME" > "TV Menu" > "Setup" > "Option" > "Terminal setting" > "Audio select" > select "HDMI".

##### DVI/HDMI cable

- 1 Press to select "HDMI 2" from the "INPUT" menu, and then press **OK**.
- 2 Go to "HOME" > "TV Menu" > "Setup" > "Option" > "Terminal setting" > "Audio select" > select "HDMI + Analogue".

#### NOTE

- If a connected HDMI device is AQUOS LINK compatible, you can take advantage of versatile functions (Pages 27–30).
- Video noise may occur depending on the type of HDMI cable used. Make sure to use a certified HDMI cable.
- When playing the HDMI image, the best possible format for the picture will be detected and set automatically.
- An ARC (Audio Return Channel) compatible audio receiver must be connected to the HDMI 1 terminal with an ARC-compatible cable.
- All HDMI terminals support 3D image signals.

#### Supported video signal

576i, 576p, 480i, 480p, 1080i, 720p, 1080p  
See page 54 for PC signal compatibility.

#### Supported audio signal

Linear PCM, sampling rate 32/44.1/48kHz.

## Connecting external devices



### SCART connection

#### Example of connectable devices

- VCR
- DVD player/recorder

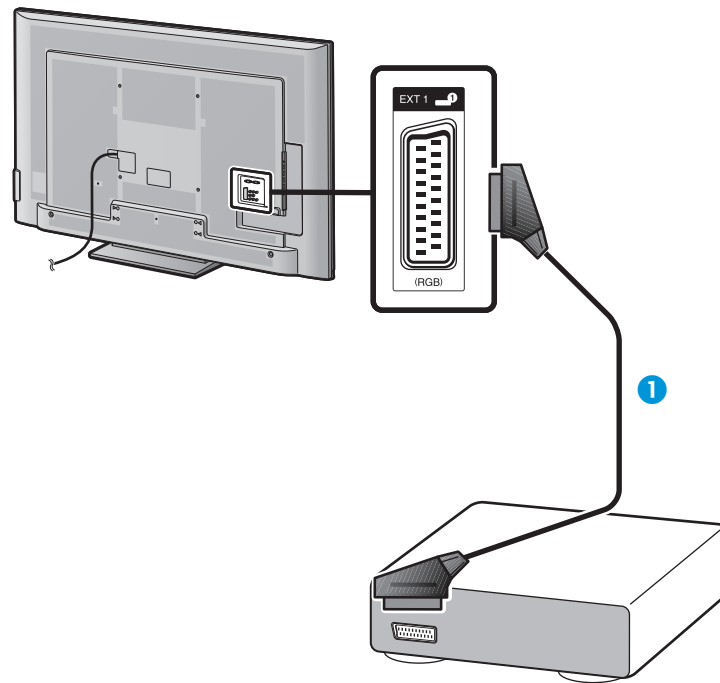

- 1 SCART cable (commercially available)

#### NOTE

- Regarding the external output:
  - You can record programmes viewed on the TV with an external recording device by connecting the external output of the TV with an SCART cable (commercially available).
  - If you change TV channels during recording from the external devices or turn off the power on the TV, the recorded content may change or be interrupted.
  - The external output may not be performed depending on the status of use.



### Component connection

#### Example of connectable devices

- VCR
- DVD player/recorder

You will enjoy accurate colour reproduction and high quality images through the EXT 3 terminal when connecting a DVD player/recorder or other device.

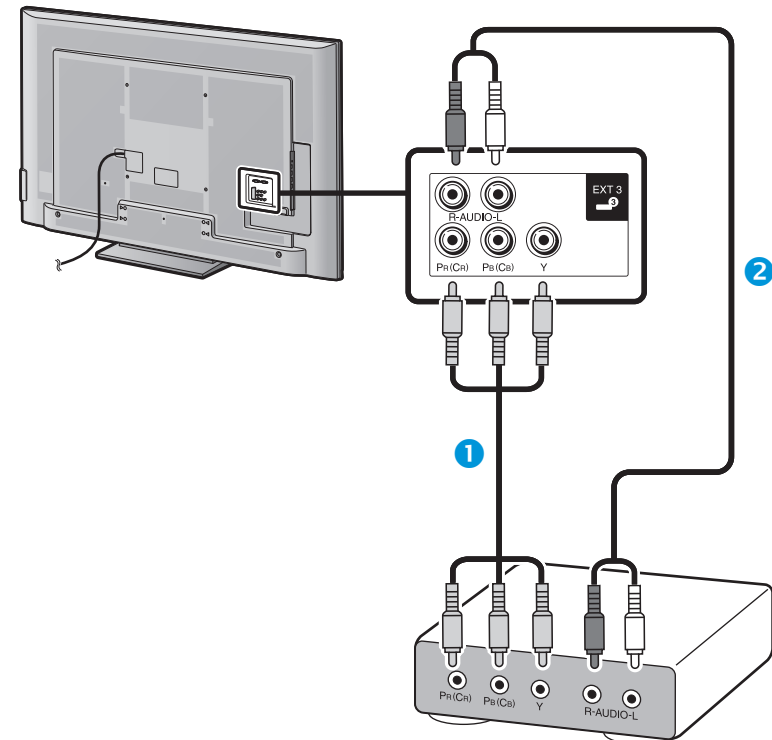

- 1 Component cable (commercially available)
- 2 Audio cable (commercially available)

## Connecting external devices

### VIDEO connection

#### Example of connectable devices

- VCR
- DVD player/recorder
- Game console
- Camcorder

You can use the EXT 2 terminal when connecting to a game console, camcorder, a DVD player/recorder or other device.

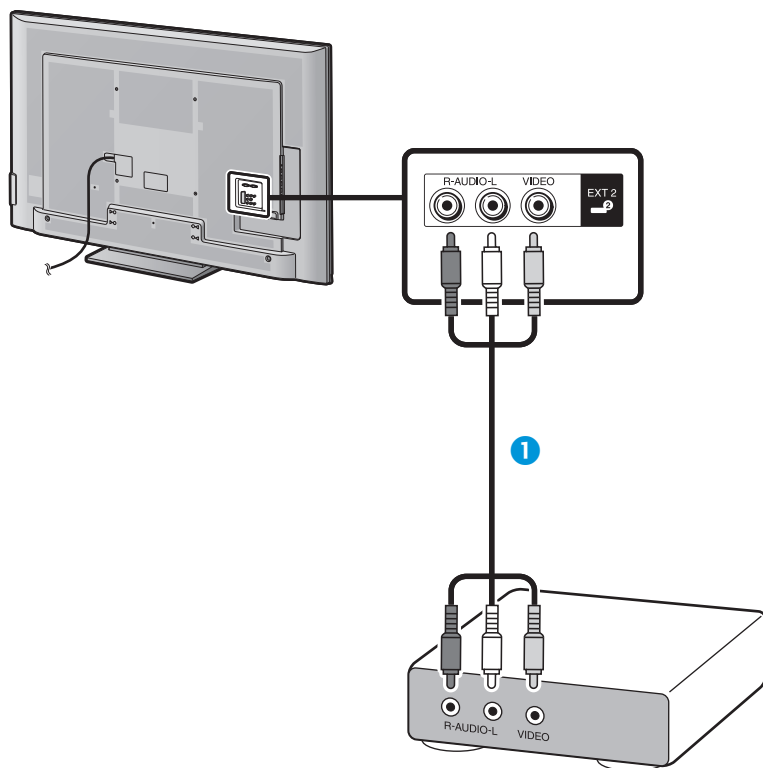

- 1 AV cable (commercially available)

### Audio connections

#### Speaker/amplifier connection

Connect an amplifier with external speakers as shown below.

#### ● Connecting an amplifier with digital/analogue audio inputs

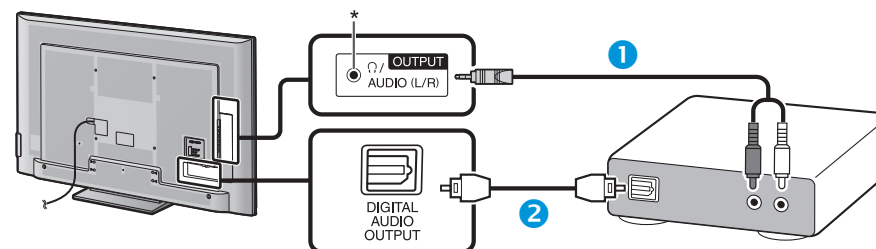

- 1 Stereo conversion cable (for analogue audio) (commercially available)  
2 Optical audio cable (for digital audio) (commercially available)

\* This terminal is also used for headphones. Reduce the volume before using headphones. Overwhelming sound may damage your hearing.

#### NOTE

- Optical digital audio will be output in 2-ch stereo when it is from the external equipment connected to the TV using an HDMI cable.
- If the image is not in sync with the audio, check the settings of the connected surround system.

#### ● After connecting

##### Digital audio output setting

After connecting an amplifier with digital audio input and external speakers as shown, you should set an audio output format compatible with the programme you are watching or the device connected.

Go to “HOME” > “TV Menu” > “Setup” > “Option” > “Terminal setting” > “Digital audio output” > select “PCM” or “Dolby Digital”.

#### NOTE

- When set to “Dolby Digital”, Dolby Digital is output when the Dolby Digital or Dolby Digital Plus audio formats are received. When set to “PCM”, PCM is output no matter what audio formats are received.
- When set to “Dolby Digital”, HE-AAC audio formats can be output as Dolby Digital.
- When set to “Dolby Digital”, Dolby Digital Plus can be output as Dolby Digital.

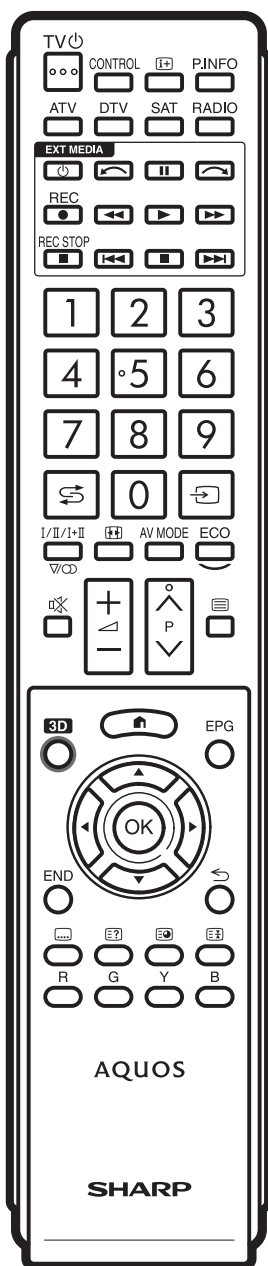

## Controlling HDMI devices using AQUOS LINK

### ● What is AQUOS LINK?

Using the HDMI CEC protocol, with AQUOS LINK you can interactively operate compatible system devices (AV amplifier, DVD player/recorder, Blu-ray player/recorder) using a single remote control unit.

#### NOTE

- AQUOS LINK-compatible AQUOS AUDIO speaker system and AQUOS recorder are scheduled to be on sale after the release of this TV.
- AQUOS LINK does not work while using time shift functions.

### ● What you can do with AQUOS LINK

#### ■ One touch recording (DTV/SAT only)

You do not have to search for the remote control unit of your recording device. Press the **REC** ● or **REC STOP** ■ buttons to start/stop recording what you see on the recorder.

#### ■ One touch play

When the TV is in standby mode, it will automatically turn on and play back the image from the HDMI source.

#### ■ Single remote control operation

AQUOS LINK automatically recognises connected HDMI devices and you can control the TV and the devices as if using a universal remote control unit.

#### ■ Operating title list of external devices

In addition to displaying the TV's own timer list (Page 21), you can also call up the external player's top menu or AQUOS BD player's/AQUOS recorder's title list provided that the devices support AQUOS LINK.

#### ■ Multiple control of HDMI devices

You can select which HDMI device to operate using the "Link operation" menu.

#### NOTE

- When you use AQUOS LINK, make sure to use a certified HDMI cable.
- Point the remote control unit toward the TV, not to the connected HDMI device.
- Video noise may occur depending on the type of HDMI cable used. Make sure to use a certified HDMI cable.
- Up to three HDMI recording devices, one AV amplifier and three players can be connected using this system.
- These operations affect the HDMI device selected as the current external source. If the device does not operate, turn on the device and select the appropriate external source using .
- When you insert/remove HDMI cables or change connections, turn on all connected HDMI devices before turning on the TV. Confirm that picture and audio are correctly displayed/output by selecting "HDMI 1", "HDMI 2", "HDMI 3" or "HDMI 4" from the "INPUT" menu.

### Regarding "Select recording device"

Select the device for recording from connected devices.

#### NOTE

- This function enables you to select either the USB storage device for time shift use or the HDMI device with CEC protocol.

- 1 Go to "HOME" > "TV Menu" > "Setup" > "View setting" > "Select recording device".
- 2 Select the device for recording using the **REC** ● button on the remote control unit.
  - Select "USB storage" when using the **REC** ● button for time shift recording.
  - Select "HDMI device" when using the **REC** ● button for recording to the HDMI device.
- 3 Press the  (Return) to end the operation.

## AQUOS LINK connection

First connect the AQUOS AUDIO speaker system or an AQUOS BD player/AQUOS recorder that supports the HDMI CEC protocol.

### Connecting an AQUOS BD player/AQUOS recorder via the AQUOS AUDIO speaker system

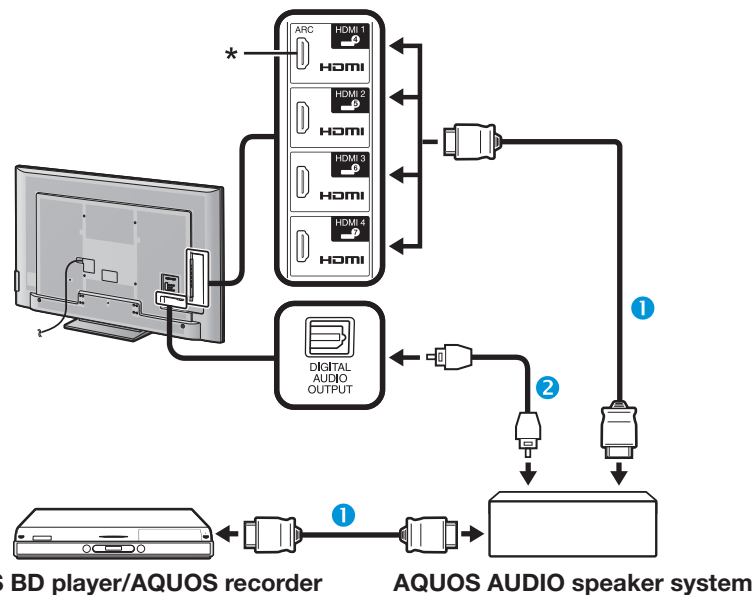

- ① HDMI-certified cable (commercially available)
- ② Optical audio cable (commercially available)

\* The ARC (Audio Return Channel) function works only when using the HDMI 1 terminal.

### NOTE

- Refer to the operation manual of the device to be connected for further details.
- After unplugging connection cables or changing the connection pattern, turn on the power of the TV after all relevant devices' power have been turned on. Change the external input source by pressing , select the appropriate external source and verify the audiovisual output.
- The cables illustrated in the following explanation are commercially available items.

### Connecting an AQUOS BD player/AQUOS recorder only

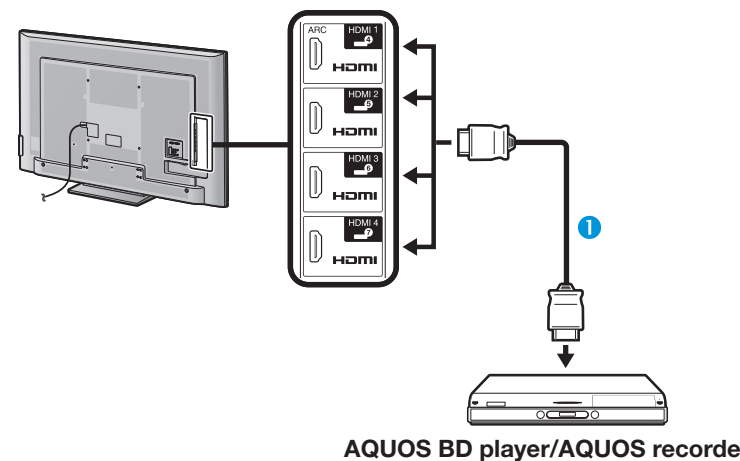

- ① HDMI-certified cable (commercially available)

### AQUOS LINK setup

#### Basic operation

Go to “HOME” > “TV Menu” > “Link operation” > “AQUOS LINK setup” > select the menu you want to set.

#### AQUOS LINK control

Set to “On” to enable HDMI CEC functions.

#### Auto power on

If this is activated, the one touch play function is enabled. While the TV is in standby mode, it automatically turns on and plays back the image from the HDMI source.

#### NOTE

- The factory default for this item is “Off”.

#### Selecting recorder

Here, you can select a recorder for the recording from several connected recorders.

#### NOTE

- If you have connected the AQUOS AUDIO speaker system between the TV and an AQUOS recorder, the external source’s indication changes (e.g., from “HDMI 1” to “HDMI 1 (Sub)”).

#### Selecting channel key

This function allows you to select the channel of the connected HDMI device using the TV’s remote control unit.

- 1 Press ▲/▼ to select the input source of the connected HDMI device you want to control using the TV’s remote control unit, and then press **OK**.
- 2 Press ◀/▶ to select “On”, and then press **OK**.

#### Using genre info.

This function allows you to automatically switch to the appropriate sound mode depending on the genre information included the digital broadcast.

#### Audio return channel (ARC)

If this function is set to “Auto”, the TV can send audio data for video content shown on the TV to a connected audio device with just one ARC-compatible cable. Using this function eliminates the need to use a separate digital or analogue audio cable.

#### Connection for using “Audio return channel”

- You need to use ARC-compatible cables/devices and connect to the HDMI 1 terminal to activate this function. The connection method is the same as **Connecting an AQUOS BD player/AQUOS recorder via the AQUOS AUDIO speaker system (Page 28)**.

### Operating an AQUOS LINK device

AQUOS LINK allows you to operate the HDMI-connected device with a single remote control unit.

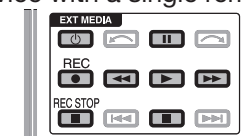

- 1 Press ▶ to start playback of a title.
  - See the section **Top menu/title list** if you want to start playback using the list of the titles in the AQUOS BD player/AQUOS recorder.
- 2 Press ►► to fast forward.
  - Press ◀◀ to reverse.
  - Press **REC** ● to start recording.
  - Press **REC STOP** ■ to stop recording.
  - Press ■ to stop.
  - Press || to pause.
  - Press ⏻ | to turn the HDMI-connected device on/off.

#### NOTE

- Refer to **Regarding “Select recording device” (Page 27)**, when the buttons for AQUOS LINK devices do not work.

### AQUOS LINK menu

You can select the AQUOS LINK menu from the “Link operation” menu to arrange the settings for sound or an external device.

#### Recorder power on/off

You can call up the CEC-compatible recorder’s EPG and preset timer recordings using the TV’s remote control unit.

- 1 Press ▲/▼ to select “Recorder power on/off”, and then press **OK**.
  - The external input source switches and the recorder’s EPG is displayed.
- 2 Select the programme to record.
  - Refer to the operation manual of the recorder for details.

### Top menu/title list

This section explains how to play back a title in the AQUOS BD player/AQUOS recorder.

- 1 Press **▲/▼** to select “Top menu/title list”, and then press **OK**.
  - The linked recorder now powers on and the TV automatically selects the appropriate external input source.
  - The title list data from the connected AQUOS BD player/AQUOS recorder displays.
- 2 Press **MENU** to hide the menu screen to operate **▲/▼/◀/▶** buttons.
- 3 Select the title with **▲/▼/◀/▶**, and then press **PLAY ▶**.

### Setup menu

You can call up the menu of an HDMI CEC-compatible external device (player, recorder, etc.) using the “Setup menu” function.

Press **▲/▼** to select “Setup menu”, and then press **OK**.

#### NOTE

- If a connected device does not have this function or the device is in a status where the menu cannot be displayed (recording, entering standby, etc.), this function may not be available.

### Media change

If your recorder has multiple storage media, select the media type here.

- 1 Press **▲/▼** to select “Media change”, and then press **OK**.
- 2 Select the desired medium, such as DVD recorder or HDD. The media type changes every time you press **OK**.

### Recorder EPG

You can call up the CEC-compatible recorder’s EPG and preset timer recordings using the TV’s remote control.

- 1 Press **▲/▼** to select “Recorder EPG”, and then press **OK**.
  - The external input source switches and the recorder’s EPG is displayed.
- 2 Select the programme to record.
  - Refer to the operation manual of the recorder for details.

### Change audio output device

#### By AQUOS audio SP

You can choose to listen to the TV sound only from the AQUOS AUDIO speaker system.

Press **▲/▼** to select “By AQUOS audio SP”, and then press **OK**.

- The sound from the TV speaker and headphone terminal is silenced and only the sound from the AQUOS AUDIO speaker system is audible.
- Audio description sound is not available.

#### By AQUOS SP

You can choose to listen to the TV sound only from the AQUOS TV speaker system.

Press **▲/▼** to select “By AQUOS SP”, and then press **OK**.

### Sound mode change

You can manually change the AQUOS AUDIO speaker system’s sound mode.

- 1 Press **▲/▼** to select “Sound mode change”.
- 2 The sound mode changes every time you press **OK**.
  - Refer to the operation manual of the AQUOS AUDIO speaker system for details.

### Model select

If multiple HDMI devices are connected in a daisy chain, you can specify which device to control here.

Press **▲/▼** to select “Model select”, and then press **OK**. The HDMI device changes every time you press **OK**.



# Basic adjustment

## Picture settings

Go to “HOME” > “TV Menu” > “Setup” > “Picture”.

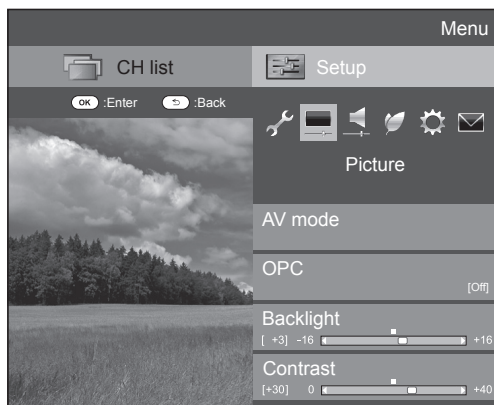

### Picture AV mode

“AV mode” gives you several viewing options to choose from to best match the system environment, which can vary due to factors like room-brightness, type of programme watched or the type of image input from external equipment.

Press ▲/▼ to select the desired mode, and then press **OK**.

- You can also switch the mode on the “Picture” and “Audio” menu screen by pressing **AV MODE**.

Item	
<b>AUTO</b>	The TV automatically sets the appropriate selection from the “AV mode” menu depending on the lighting conditions and the type of programme watched.
<b>STANDARD</b>	For a highly defined image in a normally bright room.
<b>MOVIE</b>	For viewing a movie in a darkened room.
<b>GAME</b>	For playing of video games.
<b>PC*</b>	For PC.
<b>USER</b>	Allows you to customise settings as desired. You can set the mode for each input source.
<b>DYNAMIC</b>	For a clear-cut image emphasising high contrast for sports viewing.
<b>DYNAMIC (Fixed)</b>	For a clear-cut image emphasising high contrast for sports viewing (the “Picture” and “Audio” settings cannot be adjusted).
<b>STANDARD (3D)</b>	
<b>MOVIE (3D)</b>	Refer to page 64 for details.
<b>GAME (3D)</b>	

\* “PC” is available only when selecting “HDMI 1”, “HDMI 2”, “HDMI 3”, “HDMI 4” or “PC” from the “INPUT” menu.

### NOTE

- If you select “AUTO”, some selections in the “AV mode” menu may not be automatically set.

### Picture OPC

Automatically adjusts the brightness of the screen.

Item	
<b>Off</b>	The brightness is fixed at the value set in “Backlight”.
<b>On</b>	Automatically adjusts.
<b>On:Display</b>	Displays the OPC effect on the screen while adjusting the brightness of the screen.

### NOTE

- When set to “On”, the TV senses the surrounding light and automatically adjusts the backlight brightness. Make sure no object obstructs the OPC sensor, which could affect its ability to sense surrounding light.

### Picture Picture adjustments

Adjusts the picture to your preference with the following picture settings.

#### Adjustment items

Selectable items	◀ (Cursor)	▶ (Cursor)
<b>Backlight</b>	The screen dims	The screen brightens
<b>Contrast</b>	For less contrast	For more contrast
<b>Brightness</b>	For less brightness	For more brightness
<b>Colour</b>	For less colour intensity	For more colour intensity
<b>Tint</b>	Skin tones become purplish	Skin tones become greenish
<b>Sharpness</b>	For less sharpness	For more sharpness

## Basic adjustment



### Picture

#### Advanced

This TV provides various advanced functions for optimizing the picture quality.

Go to “HOME” > “TV Menu” > “Setup” > “Picture” > “Advanced”.

#### C.M.S.-hue

This function adjusts the hue of a selected colour using a six-colour adjustment system.

#### C.M.S.-saturation

This function increases or decreases the saturation of a selected colour using a six-colour adjustment system.

#### C.M.S.-value

This function adjusts the brightness of a selected colour using a six-colour adjustment system.

#### Colour temp.

Adjusts the colour temperature to give the best white image.

Item	
High	White with bluish tone.
Mid-High	Intermediate tone between “High” and “Middle”.
Middle	Natural tone.
Mid-Low	Intermediate tone between “Middle” and “Low”.
Low	White with reddish tone.
R/G/B Gain (LO), R/G/B Gain (HI)	Adjusts the white balance by changing the value of each item.

#### Fine motion advanced

“Fine motion advanced” technologies provide superior solutions for digital display picture quality removing motion blur (“High”, “Low”, “Off”).

#### NOTE

- This effect is greater on fast moving images.
- These functions will have no effect in the following cases.
  - 1) The type of signal received is a PC signal.
  - 2) An OSD is being displayed.
  - 3) Teletext is activated.
- If images appear blurred, set to “Off”.

#### Gamma adjustment

Selects the tone difference of the brightness and darkness of the image according to the type of programme watched from a maximum of + 2 to a minimum of – 2.

#### Film mode

Automatically detects a film-based source (originally encoded at 24 or 25 frames per second, depending on the vertical frequency), analyses it and then recreates each still film frame for high-definition picture quality (“Advanced (High)”, “Advanced (Low)”, “Standard”, “Off”).

#### Active contrast

Automatically adjusts the contrast of an image according to the scene.

#### DNR

“DNR” produces a clearer image (“Auto”, “High”, “Middle”, “Low”, “Off”).

#### NOTE

- This function may not be available depending on the input signal type.

#### Range of OPC

The brightness level range of the OPC sensor’s automatic adjustments can be set according to your preferences. The adjustment range of the OPC sensor can be set to a maximum of + 16 and a minimum of – 16.

#### NOTE

- This function is available only when the “OPC” setting is set to “On” or “On:Display”.
- The maximum setting cannot be set to a smaller number than the minimum setting.
- The minimum setting cannot be set to a bigger number than the maximum setting.
- The maximum and minimum settings cannot be set to the same number.
- Depending on the brightness of the surrounding light, the OPC sensor might not operate if the adjustment range is small.

## Basic adjustment

### Audio settings

Go to “HOME” > “TV Menu” > “Setup” > “Audio”.

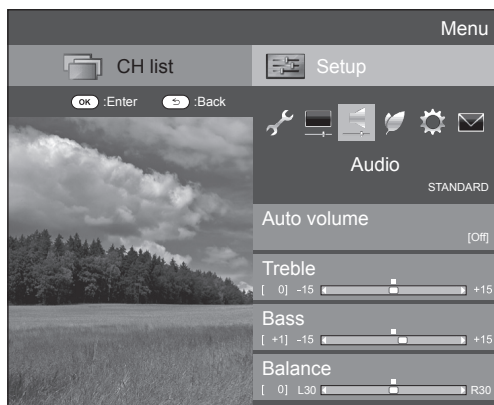

#### Audio Auto volume

Different sound sources sometimes do not have the same volume level, such as a programme and its commercial breaks. This function reduces this problem by equalizing levels.

	Item
High	Strongly reduces the volume gaps among different sound sources.
Middle	↑↓
Low	Slightly reduces the volume gaps among different sound sources.
Off	Does not adjust the volume gaps.

#### Audio Audio adjustment

You can adjust the sound quality to your preference with the following settings.

Item	◀ (Cursor)	▶ (Cursor)
Treble	For weaker treble	For stronger treble
Bass	For weaker bass	For stronger bass
Balance	Decrease audio from the right speaker	Decrease audio from the left speaker

#### Audio Surround

This function produces a surround effect from the speakers.

	Item
3D Hall	Reproduces a concert hall experience with realistic live surround sound based on reverberant sounds measured in a concert hall.
3D Movie	Reproduces a movie theater experience with realistic live surround sound based on reverberant sounds measured in a movie theater.
3D Standard	Creates three-dimensional surround sound with detailed control of the signal phase.
On	Provides limited surround sound.
Off	Outputs normal sound.

#### Audio Bass enhancer

This function allows you to enjoy bass-enhanced sound.

#### Audio Clear voice

This function emphasises speech against background noise for greater clarity.

#### Audio Audio description setting

This function allows you to enable output of audio description if the TV receives a signal including audio description.

#### NOTE

- When the “Audio description” is set to “On”, the audio description sound is superimposed on the main audio when you select a broadcast compatible with audio description.
- If you do not clearly hear the sound for the visually impaired, go to “HOME” > “TV Menu” > “Setup” > “Audio” > “Audio description setting” > “Mix level”, and select the upper level to turn up the volume.
- This function is available only for DTV broadcasts. This “Audio description setting” menu is not displayed for the ATV or the external inputs.
- The audio description sound is superimposed on the main audio only when the sound is output on the speaker sound output, headphone sound output and sound for audio out output. The sound is not output on the S/PDIF sound output and the SCART sound output.
- This function is not available for the AQUOS Audio speaker system.
- This function does not work during time shift playback.

## Basic adjustment

### Power save settings

Go to “HOME” > “TV Menu” > “Setup” > “ECO”.

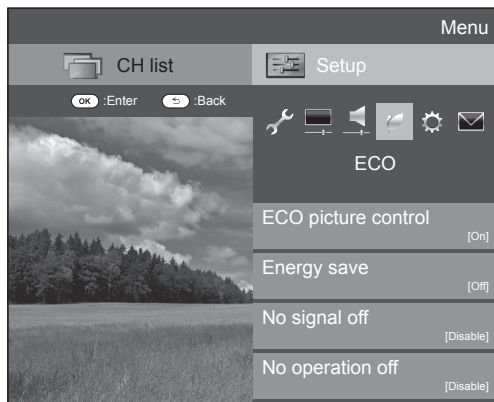

#### ECO ECO picture control

This function automatically detects the image source and decreases the power consumption while keeping the brightness of the image unchanged.

##### NOTE

- This function does not work when “AV mode” is set to “DYNAMIC (Fixed)”, “DYNAMIC” or “AUTO”.
- This function does not work when “Energy save” is set to “Standard” or “Advanced”.
- This function is greyed out in 3D mode.

#### ECO Energy save

This function enables you to reduce the backlight brightness in order to decrease the power consumption and increase the backlight life span as shown in the following table.

Item	
<b>Standard</b>	Reduces the backlight brightness.
<b>Advanced</b>	Reduces the backlight brightness more than “Standard”.
<b>Off</b>	The backlight brightness is the same value of your settings in the selected “AV mode”.

##### NOTE

- This function does not work when “AV mode” is set to “DYNAMIC (Fixed)”.

#### ● “Energy save” status icons

Icon	Description
	“Energy save” is set to “Standard”.
	“Energy save” is set to “Advanced”.

When “Energy save” is set to “Standard” or “Advanced”, “Energy save” status icons appear in the “Picture” menu and channel information windows.

#### ECO No signal off

When set to “Enable”, the TV will automatically enter standby mode if there is no signal input for 15 minutes.

##### NOTE

- Even if a TV programme finishes, this function may not operate because of interference from other TV stations or other signals.

#### ECO No operation off

The TV will automatically enter standby mode if no operations are performed in three hours if “Enable” is selected.

##### NOTE

- Five minutes before the TV enters standby mode, the remaining time displays every minute.

#### ECO Sleep timer

Allows you to set a time when the TV automatically enters standby mode. You can set the time span for entering standby mode after selecting “Change”.

##### NOTE

- Select “Off” to cancel the sleep timer.
- When the time has been set, countdown automatically starts.
- Five minutes before the preset of time expires, the remaining time displays each minute.

## Basic adjustment

### View settings

Go to “HOME” > “TV Menu” > “Setup” > “View setting”.

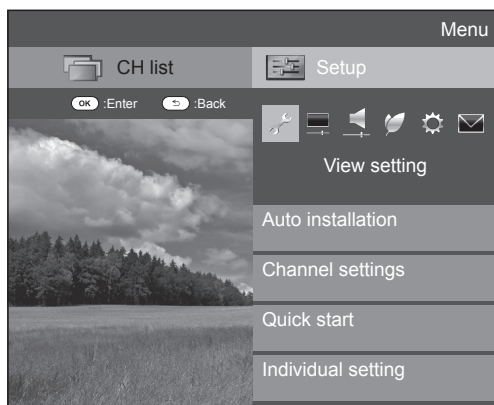

#### View setting Auto installation

The TV automatically detects and stores all available services in your area. This function also allows you to perform the channel setting for digital, satellite and analogue individually and reconfigure the settings after the initial auto installation has been completed.

- 1 Go to “HOME” > “TV Menu” > “Setup” > “View setting” > “Auto installation”.
- 2 Press ◀/▶ to select “Yes”, and then press **OK**.
- 3 Press ▲/▼/◀/▶ to select the desired language, and then press **OK**.

#### NOTE

- PIN input is required when executing “Auto installation”. The default PIN is “1234”. To change the PIN setting, refer to **Individual setting – PIN** (Page 38). To reset the PIN setting (PIN input will no longer be needed), refer to **Reset the PIN** (Page 67).
- You cannot set the Home/Store setting and the country setting in “Auto installation” in the “Setup” menu. If you want to reconfigure those settings, automatically execute initial auto installation after executing “Reset” from the “Setup” menu.
- The current country setting is displayed on the screen.

- 4 Press ▲/▼ to select the broadcast standard you want to search, and then press **OK**.

#### ● Digital search

After selecting the service you want to search, either “Terrestrial” or “Cable”, refer to **Digital broadcast setting** on page 15.

#### ● Analogue search

The TV searches for, sorts and stores all the receivable TV stations. Refer to **Analogue broadcast setting** on page 15.

#### ● Satellite search

After selecting “Satellite search”, the current DVB-S/S2 setting screen is displayed. Refer to the “Satellite search” setting on page 16.

#### Important information:

Satellite services are only available for the 740 model series.

#### NOTE

- After selecting “Next” in the DVB-S/S2 setting screen, you need to select your preferred satellite broadcast to start searching.

#### View setting Programme setup

You can reconfigure the DTV service settings automatically or manually.

- 1 Go to “HOME” > “TV Menu” > “Setup” > “View setting” > “Channel settings” > “Programme setup”.
- 2 Press ▲/▼ to select the broadcast standard you want to reconfigure, and then press **OK**.

#### NOTE

- PIN input is required when executing “Programme setup”. The default PIN is “1234”. To change the PIN setting, refer to **Individual setting – PIN** (Page 38). To reset the PIN setting (PIN input will no longer be needed), refer to **Reset the PIN** (Page 67).

### Digital setting

#### Terrestrial

You can reconfigure the following settings when you select “Terrestrial” in the initial auto installation or the “Auto installation” menu.

#### ● Additional search

Use this menu to add new services automatically after “Digital search” in the “Auto installation” menu has been completed.

#### ● Manual search

Add new services within a specified frequency band.

- Enter the frequency using **0–9** numeric buttons.
- You can perform “Manual search” with a service number only when the five Nordic countries have been selected in the country setting.

#### ● Manual adjust

Configure various settings for each service using the colour (**R/G/Y/B**) buttons.

Service no.	Service name	Lock	CH skip	Old LCN
DTV 993	SIT 3			
DTV 994	SIT 2	✓		
DTV 995	SIT 1		✓	

Service no.	Service name
DTV 999	HD Monosco

At the bottom of the screen, there are four color-coded buttons: **R** : Lock, **G** : CH skip, **Y** : Delete, **B** : Sort.

- 1 Press ▲/▼ to select the desired service.
- 2 Press the colour button on the remote control unit corresponding with the item you want to reconfigure.
  - The ✓ mark indicates the operation is set to on. Each time the colour button is pressed, you can switch the corresponding operation on/off.

## Basic adjustment

### Buttons for “Manual adjust” operation

**Lock** Press R button.

When the service is locked, you must enter your PIN whenever you tune to the service.

**CH skip** Press G button.

Services with a ✓ mark are passed over when pressing **P**  $\wedge$  /  $\vee$  on the TV or remote control unit.

**Delete** Press Y button.

The selected service is deleted. If you want to watch the service you deleted once again, perform “Auto installation”, “Additional search”, or “Manual search”.

**Sort** Press B button.

The item position of services can be sorted.

- Press  $\blacktriangle$  /  $\blacktriangledown$  to select the service whose item position you want to move, and then press **OK**.

DTV	994	SIT 2	✓
DTV	995	SIT 1	✓

- Press  $\blacktriangle$  /  $\blacktriangledown$  to move it to the desired position, and then press **OK**.

DTV	994	SIT 1	✓
DTV	995	SIT 2	✓

- Repeat steps 1 and 2 until all desired service items are sorted.

### Cable

You can reconfigure the following settings when you select “Cable” in the initial auto installation or the “Auto installation” menu.

#### Additional search

Use this menu to add new services automatically after “Digital search” in the “Auto installation” menu has been completed. Follow steps **1** to **5** in **Searching for cable broadcasts** on page 15.

#### Manual search

Add new services within a specified frequency band. After setting the items on the following screen, the TV starts searching.

- Refer to the table about menu items in the centre column on page 15.

Frequency	[47.0]	47.0 MHz
Symbol rate	[6900]	
QAM modulation	[64]	
Search start		

#### Manual adjust

This function is the same as in “Terrestrial”. Refer to “Manual adjust” in “Terrestrial”.

#### NOTE

- Some functions may not display or be selectable depending on the country setting or cable provider selection.

### Satellite setting (740 series only)

Before selecting the type of search in “Satellite setting”, you need to select the satellite broadcast.

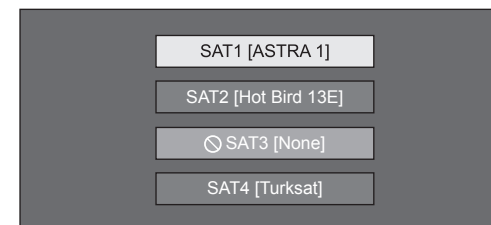

#### Additional search

Use this menu to add new services automatically after auto installation has been completed. Follow steps 1 to 2 in the right column on page 16.

#### Manual search

Add new services within a specified frequency band. After setting the items on the following screen, select “Yes” from “Search start” menu.

Band	[Vert/Low]	Vert/Low Vert/High Horiz/Low Horiz/High
Frequency	[12750]	
Symbol rate	[27500]	
Search start		

#### Manual adjust

This function is the same as in “Digital setting”. Refer to “Manual adjust” in “Digital setting”.

## Basic adjustment

### Analogue setting

You can reconfigure the analogue TV channels settings automatically or manually.

#### ● Additional search

Use this menu to add new services automatically after “Analogue search” in the “Auto installation” menu has been completed.

- Start searching channels after selecting the colour system and sound system.

#### ● Manual adjust

Use this menu to set up analogue TV channels manually.

After selecting “Yes” on the screen, press ▲/▼/◀/▶ to select the channel you want to set and then press **OK**.

### Fine

You can adjust the frequency to the desired position.

#### NOTE

- Adjust while checking the background picture as a reference.
- You can set by directly entering the frequency number of the channel with **0–9** numeric buttons.

#### EXAMPLE

- 179.25 MHz: Press 1 > 7 > 9 > 2 > 5.
- 49.25 MHz: Press 4 > 9 > 2 > 5 > **OK**.

### Colour sys.

Select the optimum colour system to receive (“Auto”, “PAL”, “SECAM”).

### Sound sys.

Select the optimum sound systems (broadcasting systems) to receive (“B/G”, “D/K”, “I”, “L/L”).

### Label

When a TV channel sends its network name, the “Auto installation” detects the information and assigns a name to it. However, you can change channel names individually.

Select each character of the new name for the channel with using the software keyboard (Page 13).

#### NOTE

- The name can be five characters or less.

### Skip

Channels with “Skip” set to “On” are passed over when using **P**▲/▼ even if selected while watching the image from the TV.

### Lock

You can block the viewing of any channel.

#### NOTE

- See “PIN” for setting a PIN.
- When “Lock” is set to “On” for a channel, “Child lock has been activated” displays, and the image and sound of the channel are blocked.
- When pressing ⏏ while “Child lock has been activated” displays, the PIN input window will display. Inputting the correct PIN unlocks the “PIN” temporarily until the power is turned off.

#### ● Sort

Channel positions can be sorted freely.

- 1 Press ◀/▶ to select “Yes”, and then press **OK**.
- 2 Press ▲/▼/◀/▶ to select the channel you want to move, and then press **OK**.
- 3 Press ▲/▼/◀/▶ to move it to the desired position, and then press **OK**.
- 4 Repeat steps 2 and 3 until all desired channels are sorted.

#### ● Erase programme

Channels can be erased individually.

- 1 Press ◀/▶ to select “Yes”, and then press **OK**.
- 2 Press ▲/▼/◀/▶ to select the channel you want to erase, and then press **OK**.
  - A message window pops up.
- 3 Press ◀/▶ to select “Yes”, and then press **OK** to erase the selected channel. All the subsequent channels move up.
- 4 Repeat steps 2 and 3 until all desired channels are erased.

## Basic adjustment

### TV start-up time setting

#### View setting Quick start

You can reduce the TV's start-up time after turning on the power with the remote control unit.

Go to "HOME" > "TV Menu" > "Setup" > "View setting" > "Quick start".

Item	
On	The TV quickly starts up from standby. Around 15 W or more of power consumption is required during standby.
Auto (Time shift)	The "Quick start" mode will automatically turn on and off depending on the time shift status. If playable data exists on the USB storage device registered for time shift, "Quick start" will be automatically set to the same status as "On".
Off	Power consumption is small during standby.

#### NOTE

- You cannot select "Off" in the "Quick start" menu while time shift is activated. Follow the on-screen instructions to change the "Quick start" settings.
- If you want to clear the playable data, go to "HOME" > "TV Menu" > "Setup" > "View setting" > "Time shift setting" > "Clear the Time shift memory" (Page 47).

### Individual setting — PIN

#### View setting PIN

Allows you to use a PIN to protect certain settings from being accidentally changed.

Go to "HOME" > "TV Menu" > "Setup" > "View setting" > "Individual setting" > "PIN".

#### NOTE

- PIN input is required when executing "PIN". The default PIN is "1234". To reset the PIN setting (PIN input will no longer be needed), refer to **Reset the PIN** (Page 67).

#### ● When selecting "Yes"

Register a four-digit number to use the "PIN" function.

- Press ◀/▶ to select "Yes", and then press **OK**.
- Enter the four-digit number as a PIN using 0–9 numeric buttons.
- Enter the same four-digit number as in step 2 to confirm.
  - "The system PIN has been changed successfully" displays.
- Press **OK**.

#### NOTE

- As a precautionary measure, make a note of your PIN and keep it in a safe place that children cannot reach.
- "0000" cannot be set as the PIN code.
- To view a locked channel, you must enter the PIN (see pages 36 and 37 for locking channels from viewing in DTV, SAT and ATV mode). When you select a locked channel, a PIN prompt message pops up. Press ⏪ to display the PIN input window.

#### View setting Parental rating

This function allows DTV services to be restricted. It prevents children from watching violent or sexual scenes that may be harmful.

- Go to "HOME" > "TV Menu" > "Setup" > "View setting" > "Individual setting" > "Parental rating".
- Repeat steps 1 to 4 in **when selecting "Yes"** to the left.

#### NOTE

- "Universal viewing" and "Parental approval pref." are ratings used exclusively in France.
- Refer to page 75 for details about ratings.

### Individual setting — Clock

#### View setting Clock setup

You can adjust the time manually and change the clock display.

Go to "HOME" > "TV Menu" > "Setup" > "View setting" > "Individual setting" > "Clock setup".

#### Time adjustment

This function allows you to set the clock manually.

#### NOTE

- If you select "No", the TV will try to get the time for the broadcast.

#### Time display

This function allows you to display the clock time in the lower-right corner of the screen.

Item	
On	Displays the clock time.
On (half-hourly)	Displays the clock time in 30-minute increments.
Off	Hides the clock time.

#### Time format

You can select the time format (either "24HR" or "AM/PM") for the clock time.



## Basic adjustment

### Individual setting — Language



Set up to three preferred multi audio languages to display if the audio languages are available.

Go to "HOME" > "TV Menu" > "Setup" > "View setting" > "Individual setting" > "Digital audio language".

#### ● Switching the multi audio languages

Each time you press  $\frac{I/II}{\nabla/O}$  on the remote control unit, the audio language switches.



Set up to two preferred subtitle languages (including subtitles for the hearing impaired) to display if subtitles are available.

Go to "HOME" > "TV Menu" > "Setup" > "View setting" > "Individual setting" > "Subtitle".

#### Selectable items

- 1st language
- 2nd language
- For hearing impaired

#### ● Switching subtitle languages

Each time you press  $\square$  on the remote control unit, the subtitle switches.

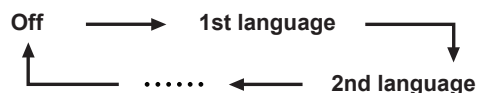

#### ● Set "For hearing impaired" to "Yes"

Subtitles for the hearing impaired have priority over each of the subtitle language settings (e.g., "1st language", "2nd language", etc.).

#### EXAMPLE

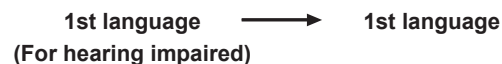

#### NOTE

- Subtitles will not be displayed when the programme does not contain subtitle information.
- Subtitles may not be displayed properly in 3D mode.



You can select an OSD language from among 26 languages. Refer to the **OSD language** column in the specification table for the selectable languages (Page 72).

Go to "HOME" > "TV Menu" > "Setup" > "View setting" > "Language".

# Useful viewing functions

## Optional features settings

Go to “HOME” > “TV Menu” > “Setup” > “Option”.

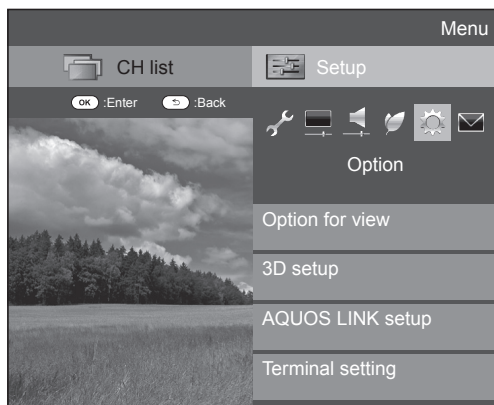

### Selecting the picture size manually

#### Option Wide mode

You can select the picture size. Selectable picture size varies with the type of signal received.

- Go to “HOME” > “TV Menu” > “Setup” > “Option” > “Option for view” > “Wide mode”.
  - You can also select an item by pressing **[F4]** on the remote control unit.
  - The menu lists the “Wide mode” options selectable for the type of video signal currently received.
- Press **▲/▼** to select the desired item.
  - As you toggle the options, each is immediately reflected on the screen. There is no need to press **OK**.

Basically, if you set “WSS” to “On” in the “Option” menu, the optimum “Wide mode” is automatically chosen for every broadcast or programme played using a VCR or DVD player/recorder.

#### NOTE

- Even if you select your desired “Wide mode” manually, the TV may automatically switch to the optimum “Wide mode” depending on the signal received when “WSS” is set to “On”.

Item (for SD [Standard-Definition] signals)	
<b>Normal</b>	Keeps the original aspect ratio in a full screen display.
<b>Zoom 14:9*</b>	For 14:9 letterbox pictures. A thin side bar appears on each side, and you may also see bars on the top and bottom with some programmes.
<b>Panorama</b>	In this mode, the picture is stretched toward each side of the screen. The picture may appear similar to “Full” depending on broadcast signals.
<b>Full</b>	For 16:9 squeeze pictures.
<b>Cinema 16:9</b>	For 16:9 letterbox pictures. Bars may appear on the top and bottom with some programmes.
<b>Cinema 14:9*</b>	For 14:9 letterbox pictures. Bars may appear on the top and bottom with some programmes.

\* The items will be displayed in ATV/DTV/SAT mode.

Item (for HD [High-Definition] signals)	
<b>Full</b>	Displays with an overscan image. Crops all sides of screen.
<b>Underscan</b>	Displays with an underscan image only when receiving a 720p signal. Displays with the High-Definition image adjusted optimally. Noise may appear on the edge of the screen with some programmes.
<b>Dot by Dot</b>	Displays an image with the same number of pixels on the screen when receiving 1080i/1080p signals only.

#### NOTE

- Some items do not appear depending on the type of received signal.
- You may not be able to change the wide mode while in 3D mode.
- Refer to page 52 for PC signal inputs.

### Selecting the WSS picture size automatically

#### Option WSS

The “WSS” allows the TV to switch automatically among the different picture size.

Go to “HOME” > “TV Menu” > “Setup” > “Option” > “WSS”.

#### NOTE

- Use “Wide mode” if an image does not switch to the appropriate picture size. When the broadcast signal contains no “WSS” information, the function will not work even if enabled.
- This function is available for 3D images converted from 2D images or normal 2D images.

### Selecting the WSS picture size manually

#### Option 4:3 mode

The “WSS” signal has 4:3 auto-switching that allows you to select between “Normal” and “Full”.

Go to “HOME” > “TV Menu” > “Setup” > “Option” > “4:3 mode”.

Item	
<b>Normal</b>	Normal range keeping 4:3 or 16:9 aspect ratio.
<b>Full</b>	Wide image without side bars.

#### WSS signal 4:3 screen

4:3 mode  
“Normal”



4:3 mode  
“Full”



## Useful viewing functions

### Terminal setting

#### Option Audio select

When using the PC terminal or HDMI 2 terminal, you must select which terminal uses the AUDIO (L/R) jack for analogue audio input.

Go to "HOME" > "TV Menu" > "Setup" > "Option" > "Terminal setting" > "Audio select".

When selecting "HDMI 2" from the "INPUT" menu

Item	
HDMI	When connecting devices (including a PC) with a HDMI cable to the HDMI 2 terminal.
HDMI + Analogue	When connecting devices (including a PC) with a DVI/HDMI cable to the HDMI 2 terminal and inputting analogue audio signals from the AUDIO (L/R) jack.

When selecting "PC" from the "INPUT" menu

Item	
Video	When connecting devices with an AV cable to the PC terminal, displays images without audio.
Video+Audio	When connecting a PC to the PC terminal, and inputting analogue audio signals from the AUDIO (L/R) jack.

### Skipping specified inputs

#### Option Input skip

This setting allows you to skip the inputs on the input source selection operation.

Go to "HOME" > "TV Menu" > "Setup" > "Option" > "Terminal setting" > "Input skip".

#### NOTE

- When you select "ATV", "DTV" or "SAT", the skip function works only when using the  button on the TV.

### Input source settings

#### Option Input select

For setting the signal type of external equipment.

- Press  to select the input source for setting the input signal ("EXT1") from the "INPUT" menu, and then press **OK**.
- Go to "HOME" > "TV Menu" > "Setup" > "Option" > "Terminal setting" > "Input select".

Item	
EXT1	Y/C, CVBS, RGB

#### NOTE

- If no (colour) image displays, try changing to another signal type.
- Check the operation manual of the external equipment for the signal type.

#### Option Input label

You can label each input source with a custom description.

- Press  to select the desired input source from the "INPUT" menu, and then press **OK**.
- Go to "HOME" > "TV Menu" > "Setup" > "Option" > "Terminal setting" > "Input label".
- Select each character of the new name for the input source with using the software keyboard (Page 13).

#### NOTE

- The label can be six characters or less.
- This menu can be changed in the case of the following input sources:
  - EXT1-3
  - HDMI1-4
  - PC

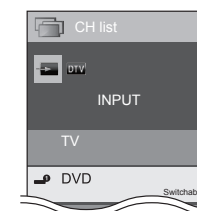

### Selecting the HDMI picture size automatically

#### Option HDMI auto view

This function allows you to automatically change to the appropriate picture size when viewing an HDMI signal using the HDMI 1, 2, 3 and 4 terminals.

- Press  to select the input source ("HDMI 1", "HDMI 2", "HDMI 3" or "HDMI 4") connected to your HDMI device, and then press **OK**.
- Go to "HOME" > "TV Menu" > "Setup" > "Option" > "Terminal setting" > "HDMI auto view".

## Useful viewing functions



Option

### Headphone/Audio out select

You can select which device is used for outputting audio.

Go to “HOME” > “TV Menu” > “Setup” > “Option” > “Terminal setting” > “Headphone/Audio out select”.

Item	
Headphone	Output audio through headphones.
Audio out	Output audio through an A/V receiver or surround audio controller.

### CAUTION

- This terminal is also used for headphones. Reduce the volume before using headphones. Overwhelming sound may damage your hearing.

### NOTE

- If you select “Audio out” when a cable is inserted in the HDMI 2/PC AUDIO (L/R) terminal, the TV speakers are muted.
- When you select “Audio out”, you can adjust the TV sound volume with the  $\triangle$ +/- buttons.



Option

### Headphone out setting

You can select the headphone/speaker audio output when using the headphones.

Go to “HOME” > “TV Menu” > “Setup” > “Option” > “Terminal setting” > “Headphone out setting”.

Item	
Headphone	Audio output from headphones only.
Dual	Audio output from headphones and speakers.

### NOTE

- This function does not work when “Change audio output device” (Page 30) is set to “By AQUOS audio SP” or “Headphone/Audio out select” is set to “Audio out”.
- Regarding the volume adjustment when “Dual” is set:
  - Adjust the speaker volume with the  $\triangle$ +/- buttons on the remote control unit.
  - Adjust the headphone volume with the  $\triangle$ +/- buttons on the TV.
  - The headphone volume is not muted even by pressing  $\otimes$  (Mute) button on the remote control unit.
- When not using the headphones:
  - Audio outputs from the speakers regardless of the settings.



Option

### Colour system

You can change the colour system to one that is compatible with the image on the screen.

Go to “HOME” > “TV Menu” > “Setup” > “Option” > “Colour system”.

### NOTE

- The factory preset value is “Auto”.
- If “Auto” is selected, the colour system for each channel is automatically set. If an image does not display clearly, select another colour system (e.g., “PAL”, “SECAM”).

### Screen effect settings



Option

### Channel selecting effect

This function shows a screen effect when choosing or changing channels.

Go to “HOME” > “TV Menu” > “Setup” > “Option” > “Screen effect” > “Channel selecting effect”.



Option

### Programme title display

This function allows you to display programme information such as the title and airtime by tuning a channel.

Go to “HOME” > “TV Menu” > “Setup” > “Option” > “Screen effect” > “Programme title display”.

### NOTE

- This function is available only when the DTV/SAT mode is selected.

### Adjusting image position



Option

### Position

For adjusting a picture’s horizontal and vertical position.

Go to “HOME” > “TV Menu” > “Setup” > “Option” > “Screen effect” > “Position”.

Item	
H-Pos.	Centres the image by moving it to the left or right.
V-Pos.	Centres the image by moving it up or down.

### NOTE

- Adjustments are stored separately for each input source.
- Depending on the input signal type, “Wide mode” setting or “Video mode” for the USB media mode, a position setting may not be available.
- This function is not available for DTV broadcasts with MHEG signals.
- This function is available for 3D images converted from 2D images or normal 2D images.

## Useful viewing functions

### Additional features

#### Option Illumination

This function makes the LED on the front of TV illuminated in several ways.

Go to “HOME” > “TV Menu” > “Setup” > “Option” > “Illumination”.

Item	
<b>Off</b>	The LED is not illuminated.
<b>Standby</b>	The LED is illuminated while the TV is in standby mode.
<b>Watch</b>	The LED is illuminated while you watch TV.
<b>Always</b>	The LED is illuminated all the time.

#### NOTE

- The factory default for this item is “Watch”. Set to “Off” if you do not want the LED to illuminate.
- The LED is illuminated in white for 2D mode.
- The LED is illuminated in blue for 3D mode.

#### Option Game play time

This function allows you to display the elapsed time on the screen when “AV mode” is set to “GAME”.

Go to “HOME” > “TV Menu” > “Setup” > “Option” > “Game play time”.

Item	
<b>On</b>	Under connecting a game console to the TV, the elapsed time is displayed in 30-minute increments after you start playing a game.
<b>Off</b>	Hides the time.

#### NOTE

- This menu can be selected in the case of the following input sources:
  - EXT1–3
  - HDMI1–4
  - PC

#### Option Key lock

This function allows you to lock the buttons on the TV or remote control unit in order to prohibit children from changing the channel or volume.

Go to “HOME” > “TV Menu” > “Setup” > “Option” > “Key lock”.

Item	
<b>Off</b>	Unlocks the buttons.
<b>RC control lock</b>	Locks all buttons on the remote control unit.
<b>Button control lock</b>	Locks the buttons on the TV except the power switch.

#### NOTE

- You cannot set both “RC control lock” and “Button control lock” at the same time.

#### ● Cancelling the lock

Press **MENU** on the TV and set to “Off” to cancel the “RC control lock”. Press **MENU** on the remote control unit and set to “Off” to cancel the “Button control lock”.

- Refer to page 19 for menu operation using **MENU** on the TV.

## Other useful features

### Time shift +

You can enjoy DTV/SAT recording or playback by connecting a commercially available USB storage device to the TV.

- Time shift + does not work for ATV, external inputs, data broadcasts, radio broadcasts or network applications.

### Connecting a USB storage device

Connect a commercially available USB storage device to the USB port of the TV.

- USB storage device: USB memory or USB HDD
- Be sure to read the operation manual for the USB storage device.
- At least USB storage devices with memory between 1GB and 2TB and under are required for time shift to register.
- The USB 2 (HDD) port is compatible with portable USB HDD which can operate with the power supply from the USB port (bus powered drive).
- Refer to **Disconnect the USB storage device** when removing the USB storage device (do not remove the USB storage device during time shift operation).

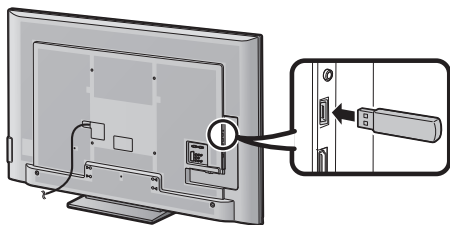

#### NOTE

- The supplied USB memory is used for the operation manual of this TV and may not be used for time shift.
- Time shift may take a few moments to start after the TV is turned on.
- This function may not work properly for some USB storage devices.
- Do not connect and disconnect a USB storage device from the TV repeatedly.

### USB storage device registration

It is necessary to first perform USB storage device registration for USB storage devices used for time shift.

Directly connect only one USB storage device to the USB port while registering the USB storage device (when two or more USB storage devices are connected, USB storage device registration is not available).

- The screen prompt pops up.

**When the USB storage device is connected to the TV**  
Register the USB storage device. Follow the on-screen instructions to register the USB storage device.

- All the data on the USB storage device is deleted after USB storage device registration.

#### NOTE

- In order to use time shift, it is necessary to change the “Quick start” setting to “Auto (Time shift)” or “On”.
- Only one USB storage device for time shift can be registered on the TV. Two or more USB storage devices for time shift cannot be used at the same time.
- If a registered USB storage device is inserted, a screen prompt will not be displayed.

### Disconnecting the USB storage device

When you disconnect the USB storage device, be sure to the following steps.

Go to “HOME” > “TV Menu” > “Setup” > “View setting” > “Time shift setting” > “Device removal”.

#### NOTE

- This menu item cannot be selected when a USB storage device for time shift is not registered.
- The USB storage device registration for time shift is cancelled in the following cases:
  - When the USB storage device is removed.
  - When another USB storage device is registered for time shift; only one USB storage device can be registered for time shift.
- Recorded data is deleted when removing the USB storage device or turning off the TV.

## Other useful features

### How to operate Time shift +

This function enables you to pause the digital TV or satellite programme you are watching and start watching it again from the paused scene.

#### CAUTION

- Do not unplug the AC cord during time shift timer setting or time shift recording.
- When the AC cord is unplugged and the TV is turned off:
  - The time shift timer setting is cancelled.
  - Recorded data is deleted.
- Time shift recording may be automatically stopped when signal reception is poor.
- Only this TV can playback the programme recorded on the USB storage device connected to this TV. The programmes cannot playback on other TV or PC.

SHARP corporation bears no responsibility regarding compensation for content when recording cannot does not take place, loss of recorded data or other direct or indirect damages related to these matters. Please be forewarned.

### Buttons for time shift operation

Remote control unit

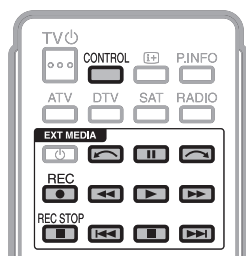

Control panel

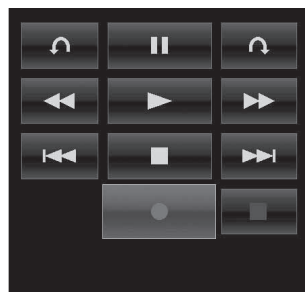

Buttons	Description
REC ●	Start recording the programme you are watching. <ul style="list-style-type: none"> <li>You cannot playback the recorded programme until approximately three seconds after pressing <b>REC ●</b> to start recording.</li> </ul>
REC STOP ■	Stop recording.
▶	Playback the recorded programme.
■	Stop the programme in playback and go back to the real time broadcast (live).
	Pause the programme in playback (time shift recording continues). <ul style="list-style-type: none"> <li>This function is released in 15 minutes.</li> </ul>
◀◀	Reverse (each time you press this button, the reverse speed changes in three levels).
▶▶	Fast forward (each time you press this button, the fast forward speed changes in three levels).
◀◀◀	Jump backward to the previous chapter point*.
▶▶▶	Jump forward to the next chapter point*.
↶	Playback will resume after jumping backward by the time interval you set in "Jump time setting" (Page 47).
↷	Playback will resume after jumping forward by the time interval you set in "Jump time setting" (Page 47).

\* Chapter points are fixed at 10 minute increments.

#### NOTE

- Refer to **Regarding "Select recording device"** (Page 27), when the buttons for time shift do not work.
- Instead of pressing buttons on the remote control unit, most of the operations shown to the left are also available on the screen with the control panel. You can call up this control panel by pressing **CONTROL** on the remote control unit or select "Control (Time shift)" from "HOME" > "TV Menu" > "Setup" > "Option" > "Option for view".
- The "Audio description setting" menu does not work during time shift playback.
- When the amount of memory used for time shift reaches "Full" and the blue point is around the left edge of the bar (see 2 and 3 in the **Counter** section on page 47), you cannot operate some functions (|| (Pause), ◀◀ (Reverse), ◀◀◀ (Jumping backward to the previous chapter point) ↶ (Jumping backward by the time interval you set in "Jump time setting")).
- Time shift recording stops if no operation detected for three hours.
- When recording operations are not stopped manually, recording will automatically stop after six hours.
- To release time shift, press **REC STOP ■**, change the DTV/SAT channel or change "INPUT".
- Some functions do not work during time shift.
- As time shift is not actually a recording function, recorded data will be reset when the TV is turned off by unplugging the AC cord.
- Time shift does not start automatically, but starts only when **REC ●** is pressed or when a time shift timer setting is started.
- The PIN is required when you use the buttons such as ◀◀, ▶▶, ◀◀◀, ▶▶▶, ↶, ↷ if you set the PIN and any options for "Parental rating" except "None" are selected.
- Do not disconnect the USB storage device used for time shift during time shift operation.

## Other useful features

### Time shift recording

You can record the programme you are watching to the registered USB storage device.

#### Starting time shift recording

- Press **REC** ●.
- The TV starts time shift recording.

#### NOTE

- You can also operate from the control panel by pressing **CONTROL**.
- You cannot switch the channel or the input source during time shift recording.
- Time shift + overwrites existing data when a new recording starts.
- The TV starts overwriting data in order from the oldest recorded data when the memory for the USB storage device is full. Use a high capacity USB storage device when you want to record longer programmes.
- During time shift recording, the TV cannot display photos or play music from the internet, Home network, or USB storage devices.
- You cannot record programmes that have a copy control signal that prohibits recording (they can only be watched on the TV).

#### Completing time shift recording

- 1 Press **REC STOP** ■.
  - The screen prompt pops up.
- 2 Press ◀/▶ to select “Yes”, and then press **OK**.
  - Time shift recording has completed.

#### NOTE

- You can also operate from the control panel by pressing **CONTROL**.

### Time shift timer setting

You can set the time shift timer setting for programmes you want to record.

#### NOTE

- To prevent the first part of the programme from being cut, start recording the programme a few seconds earlier than time set to start recording.
- When recording/viewing timer settings are set continuously for multiple programmes, schedule the recording of the previous programme to end earlier than the end of the programme itself. Recording/viewing timer setting of the next programme will start after that.
- A message will be displayed when the scheduled time overlaps with an existing schedule. Make changes in accordance with the on-screen instructions.
- It is not possible to newly schedule a recording that overlaps with a timer setting that is currently running (recording). When urgent setting of a schedule is desired, stop recording before scheduling.
- Only one time shift timer setting can be set.
- A combined total of 16 timer settings (“Watch” and “Time shift”) can be set.

#### EPG timer setup

You can select the programme you want to record and set the timer setting with EPG (Pages 21 and 22).

#### Manual timer setting

“Manual timer setting” enables you to set date, recording start/stop time and channel.

- 1 Press **EPG**.
- 2 Press **B** to display the timer list.
- 3 Press **B** again to display the “Manual timer setting” screen.
- 4 Set date, recording start/stop time and channel.
- 5 Press ◀/▶ to select “Time shift”, and then press **OK**.
  - A confirmation screen will be displayed for the timer setting.
- 6 Press ◀/▶ to select “Yes”, and then press **OK**.

### Manual clock setting

When the TV cannot receive the time via digital broadcast, perform “Manual timer setting” after setting the clock .

Go to “HOME” > “TV Menu” > “View setting” > “Individual setting” > “Clock setup” > “Time adjustment”.

#### NOTE

- You cannot set the manual clock setting during time shift recording.

### Timer list

A list of programmes scheduled for recording can be displayed.

- 1 Press **EPG**.
- 2 Press **B** to display the timer list.

### Time shift playback

Playback recorded scenes of the programme being recorded.

- Press ▶ during time shift recording.
- The last recorded programme can be replayed after the end of recording.
  - Press ■ to return the scene that is broadcasting.

#### NOTE

- You can also operate from the control panel by pressing **CONTROL**.
- Time shift playback may take a few moments to start.
- Time shift playback will stop and the TV will return to normal broadcasting when a program is fast-forwarded to a scene that is near to the scene currently being broadcast. The timing at which it returns depends on the speed of fast-forwarding.



## Other useful features

### Display information regarding time shift

Channel display	
Channel information displays by pressing  on the remote control unit.	
1	The recording icon shows up when <b>REC</b> is pressed and the TV is recording the programme.
2	The status icon shows up depending on what is shown on the screen.
3	This icon is displayed when the TV has playable time shift memory. Press  to playback the contents of the time shift memory.

Counter	
The counter displays when you set "On" in "Display the Time shift memory" (Go to "HOME" > "TV Menu" > "Setup" > "View setting" > "Time shift setting").	
1	The grey bar shows how much memory is in use.
2	This blue point shows how much time has progressed.
3	"FULL" shows up when the grey bar reaches the right edge. The TV starts overwriting the previously recorded data.

#### NOTE

- You can also call up the information above by pressing **CONTROL** on the remote control unit or select "Control (Time shift)" from "HOME" > "TV Menu" > "Setup" > "Option" > "Option for view".

### View setting Clear the Time shift memory

You can clear the time shift memory.

Go to "HOME" > "TV Menu" > "Setup" > "View setting" > "Time shift setting" > "Clear the Time shift memory".

#### NOTE

- If you perform this menu during selecting "Auto (Time shift)" in the "Quick start" menu, "Quick start" will be automatically set to the same status as "Off".

### View setting Auto input selection

You can choose whether or not to switch the input source automatically when receiving an AQUOS LINK or an Euro SCART compatible signal on the TV during time shift operations.

Go to "HOME" > "TV Menu" > "Setup" > "View setting" > "Time shift setting" > "Auto input selection".

Item	
<b>Enable</b>	Release time shift when receiving an AQUOS LINK or a Euro SCART compatible signal. Switch input source automatically.
<b>Disable</b>	Time shift continues to work. The TV does not switch input source automatically even when receiving an AQUOS LINK or a Euro SCART compatible signal.

### View setting Jump time setting

You can set the time interval for playback to resume after jumping backwards/forward.

Go to "HOME" > "TV Menu" > "Setup" > "View setting" > "Time shift setting" > "Jump time setting".

- A time interval from 10 sec. to 99 min. 50 sec can be selected.

#### NOTE

- You can use the time interval you set using the or buttons.

### View setting Device registration

You need to perform this function to register the USB storage device for the time shift.

Go to "HOME" > "TV Menu" > "Setup" > "View setting" > "Time shift setting" > "Device registration".

- Refer to **USB storage device registration** (Page 44).

#### NOTE

- Only one USB storage device can be registered for time shift. Remove all USB storage devices except the one used for time shift.
- At least USB storage devices with memory between 1GB and 2TB and under are required for time shift to register.
- Some USB storage devices, such as ones which have multiple drives, etc., cannot be used for time shift.

### View setting Device check

You can manually check the condition of a USB storage device to be used for time shifting.

Go to "HOME" > "TV Menu" > "Setup" > "View setting" > "Time shift setting" > "Device check" > select "Yes".

#### NOTE

- This menu item cannot be selected when a USB storage device for time shift is not registered.

## Other useful features

### USB media/Home network

#### USB media/Home network

In both modes, you can enjoy viewing photos, listening to music and watching videos from external USB devices (USB Memory, USB card reader (Mass Storage Class), USB HDD) or Home network server.

#### NOTE

- To connect a Home network server, refer to **Network setup** (Page 57).
- This function may not work properly for some USB storage devices.
- The corresponding file format is different between “USB media” and “Home network”.
- “Wide mode” is fixed during “Photo mode”. During “Video mode”, you can select “Auto” or “Original”.
- Depending on the Home network server, the TV may not be able to recognise the contained data.
- Use only alphanumeric characters for naming files.
- Do not disconnect a Home network server from the TV while transferring files, using the slide show function, when a screen is switching to another or before you exit “Home network” from the “HOME” or “INPUT” menu.
- Do not connect and disconnect a Home network server from the TV repeatedly.
- Depending on the USB device, the TV may not be able to recognise the contained data.
- Use only alphanumeric characters for naming files.
- File names over 80 characters (may vary depending on the character set) may not be displayed.
- Do not disconnect a USB device or memory card from the TV while transferring files, using the slide show function, when a screen is switching to another or before you exit “USB media” from the “INPUT” menu.

#### Selecting the mode

#### Common operation

Select “USB media” or “Home network” from the “HOME” or “INPUT” menu to enter this mode.

### Selecting modes and drives/servers

#### 1 Press B.

##### When the USB media menu is displayed

- Press ▲/▼ to select “Select USB drive”, and then press **OK**.
  - The available selections are “Select USB drive” and “Folder display setting”.
- Press ▲/▼/◀/▶ to select the USB device where you want to find your files, and then press **OK**.
  - You can select from “All” or “Folder” for the type of folder directory in “Folder display setting”.

##### When the Home network menu is displayed

- Press ▲/▼ to select the Home network server where you want to find your files, and then press **OK**.
- Press **Y** to search for servers.

#### 2 Press ◀/▶ to select among “Photo mode”, “Music mode” or “Video mode”, and then press **OK**.

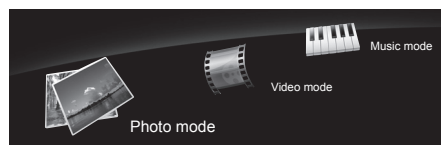

#### NOTE

- The explanations for the buttons that can be used in each mode are the explanations when using USB media mode. Some operations may differ in Home network mode. Follow the guide display during operations.
- You do not need to select the drive/server in step 1 when there is only one drive in the connected USB device or there is only one Home network server connected to the TV.
- 16 is the maximum number of drives that can be displayed in USB media mode.
- 10 is the maximum number of servers that can be displayed in Home network mode.
- You cannot enter these modes when there is no server connected to the TV in Home network mode.

### Photo mode

#### Viewing thumbnails

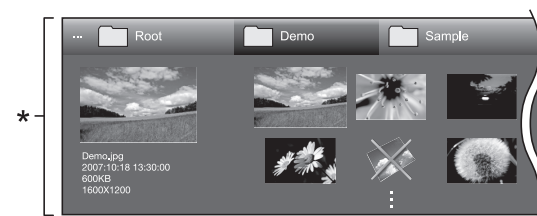

\* This screen image is for the USB media mode. It may be slightly different in the Home network mode.

#### Buttons for thumbnail operations (When using USB media mode)

Buttons	Description
<b>OK</b>	When selecting a folder icon: Enter this directory. When selecting a photo thumbnail: Enlarge the photo.
▲/▼/◀/▶ (Cursor)	Select a desired item.
↶	All*: Return to the previous screen. Folder*: Return to the upper folder. When the top folder is displayed, return to the top menu screen.
<b>R button</b>	Select/deselect items (✓ mark appears on the selected items).
<b>G button</b>	All*: Select BGM for the slide show. Folder*: Move to the top menu screen.
<b>Y button</b>	Start the slide show.
<b>B button</b>	Display “USB media menu”. <ul style="list-style-type: none"> <li>3D display</li> <li>Select slide show interval</li> <li>Select slide show BGM</li> <li>Set all slide show image</li> <li>Reset all slide show image</li> <li>USB device removal</li> </ul>

\* The mode selected in “Folder display setting”

#### NOTE

- When there are invalid photo files, the **X** mark will be displayed for the file.
- The 3D mode icon appears on the thumbnails of 3D images. If you do not switch to 3D mode for the 3D images, they will be displayed in 2D.
- You can see the file name, shooting date, file size and pixel size of the selected photo on the left of the screen (shooting date is only available in the EXIF file format).

## Other useful features

### Viewing enlarged photos

#### Buttons for enlarged photo display operation (When using USB media mode)

Buttons	Description
◀/▶ (Cursor)	Go to the previous/next photo in the same directory.
↶	Return to the thumbnail selection screen.
3D	Switch between 2D and 3D modes.
R button	Rotate the photo by 90 degrees to the left.
G button	Rotate the photo by 90 degrees to the right.
B button	Display "USB media menu". • USB device removal
i+	Reveal/hide the guide display.

#### NOTE

- Rotating photos only applies to the temporarily selected item and this setting is not saved.

### Slide show

#### Selecting the BGM

Setup the slide show BGM from "USB media menu" by pressing **B** when selecting photo thumbnails. This function is available only for the USB media mode.

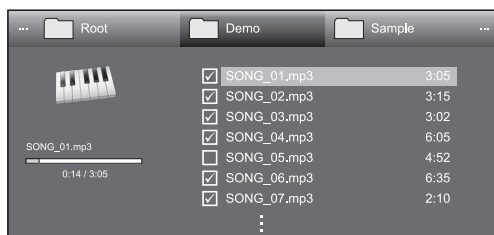

#### Buttons for slide show BGM select operation

Buttons	Description
OK	When selecting a music file: Play music.
▲/▼/◀/▶ (Cursor)	Select a desired item.

↶	When music is being played: Stop music. When music is stopped: All*: Return to the thumbnail selection screen. Folder*: Return to the upper folder. When the top folder is displayed, return to the thumbnail selection screen.
R button	Select/deselect items (✓ mark appears on the selected items).
G button	All*: Stop music. Folder*: Move to the thumbnail selection screen.
Y button	Play/pause music.
B button	Display "USB media menu". • Set all BGM • Reset all BGM • USB device removal

\* The mode selected in "Folder display setting"

#### NOTE

- Slide show BGM will be reset in the cases below.
  - Select "Reset all BGM" by pressing **B** during selecting music files.
  - Go back to the top menu.
  - Change the "INPUT".
- When there are invalid music files, the **X** mark will be displayed for the file.
- The displayed play time may differ slightly from the actual play time depending on the files.

#### Slide show

#### Buttons for slide show operation (When using USB media mode)

Buttons	Description
↶	Return to the previous operation.
3D	Switch between 2D and 3D modes.
B button	Display "USB media menu". • Select slide show interval • USB device removal
i+	Reveal/hide the guide display.

#### NOTE

- The selected BGMs are played repeatedly.
- The slide show continues until you press ↶.
- Depending on the photo, the slide show interval per photo may be longer than the interval selected in the settings.

### Music mode

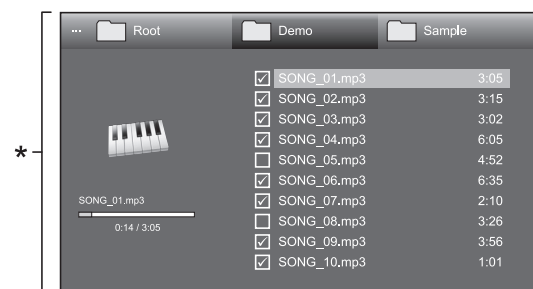

\* This screen image is for the USB media mode. It may be slightly different in the Home network mode.

#### Buttons for music mode (When using USB media mode)

Buttons	Description
OK	When selecting a music file: Play music.
▲/▼/◀/▶ (Cursor)	Select a desired item.
↶	When music is being played: Stop music. When music is stopped: All*: Return to the previous screen. Folder*: Return to the upper folder. When the top folder is displayed, return to the top menu screen.
R button	Select/deselect items (✓ mark appears on the selected items).
G button	All*: Stop music. Folder*: Stop music and move to the top menu screen.
Y button	Play/pause music.
B button	Display "USB media menu". • Set all auto play • Reset all auto play • USB device removal

\* The mode selected in "Folder display setting"

#### NOTE

- When there are invalid music files, the **X** mark will be displayed for the file.
- The displayed play time may differ slightly from the actual play time depending on the files.

## Other useful features

### Video mode

#### Buttons for file selecting operations (When using USB media mode)

Buttons	Description
OK	When selecting a folder icon: Enter this directory. When selecting a video file: Play the video.
▲/▼/◀/▶ (Cursor)	Select a desired item.
↶	All*: Return to the previous screen. Folder*: Return to the upper folder. When the top folder is displayed, return to the top menu screen.
R button	Select/deselect items (✓ mark appears on the selected items).
G button	All*: - Folder*: Move to the top menu screen.
Y button	Play the video file from the top of the file.
B button	Display “USB media menu”. • Set all auto play • Reset all auto play • USB device removal

\* The mode selected in “Folder display setting”

#### Buttons for playing mode (When using USB media mode)

Buttons	Description
OK	When video is being played: Pause the video. When video is paused: Play the video.
▲ (Cursor)	Go to the beginning of a file by pressing ▲ once and the previous file by pressing ▲ twice.
▼ (Cursor)	Go to the next file.
◀/▶ (Cursor)	Reverse/fast forward a video.
↶	Go back to the file selection screen.
3D	Switch between 2D and 3D modes.
R button	Start playback from the previously stopped scene.
G button	Stop a video.
Y button	Display the USB control panel.
B button	Display “USB media menu”. • Title (edition) • Chapter • Show video information • USB device removal
0-9	Jump to scenes at 10% increments (0%–90%). • Limited to files without chapters.
i+	Reveal/hide the guide display.

#### NOTE

- Reverse/fast forward continues from one file to another during continuous playback.
- Instead of pressing buttons on the remote control unit, the operations above are also available on the screen with the control panel. You can display this control panel by pressing **CONTROL** on the remote control unit or select “Control (USB media)” or “Control (Home network)” from “HOME” > “TV Menu” > “Setup” > “Option” > “Option for view”.
- The buttons in the EXT MEDIA on the remote control unit perform the same operations as those on the control panel.

### Disconnecting the USB device

When you disconnect the USB device, be sure to the following steps.

- 1 Press **B** on the remote control unit.
  - Display “USB media menu”.
- 2 Press ▲/▼ to select “USB device removal”, and then press **OK**.
- 3 Press ◀/▶ to select “Yes”, and then press **OK**.

### 3D mode

You can view photos in 3D mode.

- 1 Press **B** to display the “USB media menu” screen.
- 2 Press ▲/▼ to select “3D display”, and then press **OK**.
  - See pages 61–66 for details on the 3D function.

#### NOTE

- In 3D mode, you cannot rotate the photos.
- You can select “3D display” from “USB media menu” only when the thumbnails screen for the photo mode in USB media mode is displayed on the screen.

## Other useful features



View setting

### DivX® setup

This is the function to confirm your registration code. You need to register the code at [www.divx.com](http://www.divx.com).

Go to “HOME” > “TV Menu” > “Setup” > “View setting” > “DivX® setup”.

#### ● DivX® VOD registration

You can find your registration code on this menu. You need to register the TV at [www.divx.com](http://www.divx.com) before playing the DivX content.

#### ● DivX® VOD deregistration

You can find your deregistration code on this menu. You need to deregister the TV at [www.divx.com](http://www.divx.com) to release the registration.

## USB device compatibility

<b>USB device</b>	USB memory, USB card reader (Mass Storage class), USB HDD
<b>File system</b>	FAT/FAT32, NTFS
<b>Photo file format</b>	JPEG (.jpg) (DCF2.0 compliant), MP (.mpo) (CIPA DC-007)
<b>Music file format</b>	MP3 (.mp3) Bitrate: 32 k, 40 k, 48 k, 56 k, 64 k, 80 k, 96 k, 112 k, 128 k, 160 k, 192 k, 224 k, 256 k, 320 kbps Sampling frequency: 32 k, 44.1 k, 48 kHz

Video file format			
File extension	Container	Video	Audio
.avi	AVI	DivX 3.11/4.x/5.1/6.0 XviD H.264 MPEG4 Motion Jpeg	MP3 Dolby Digital LPCM ADPCM
.mkv	MKV	DivX 3.11/4.x/5.1/6.0 XviD H.264 MPEG4	MP3 Dolby Digital LPCM ADPCM
.asf .wmv	ASF	DivX 3.11/4.x/5.1/6.0 XviD MPEG4 VC-1 Window Media Video v9	MP3 Dolby Digital LPCM WMA
.mp4 .mov	MP4	H.264 MPEG4 Motion Jpeg	MP3 Dolby Digital Dolby Digital Plus AAC
.mpg .mpeg	PS	MPEG2 MPEG1	Dolby Digital MPEG LPCM

#### NOTE

- Progressive format jpeg files are not supported.
- Files in USB 1.1 devices may not be played properly.
- Operation using USB hubs is not guaranteed.
- Some video file formats may not be played depending on the file.
- Some USB devices may not work properly depending on the file system.

## Home network server compatibility

<b>Photo file format</b>	JPEG
<b>Music file format</b>	LPCM, MP3
<b>Video file format</b>	MPEG2-PS, MPEG2-TS, WMV, ASF, MP4, MOV, AVI

#### NOTE

- Progressive format jpeg files are not supported.
- Some video file formats may not be played depending on the file and server.

## Selecting the picture size for video mode

You can select the picture size in “Video mode”.

- 1 Select “Video mode”.
  - Refer to **Selecting modes and drives/servers** on page 48.
- 2 Press **[+]**.
  - The “Wide mode” menu displays.
- 3 Press **[+]** or **[▲/▼]** to select the desired item.
  - As you toggle the options, each is immediately reflected on the screen. There is no need to press **OK**.

#### EXAMPLE

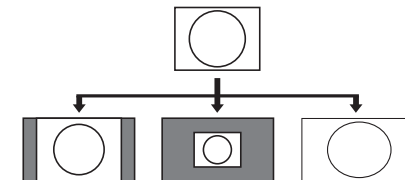

Item	
<b>Auto</b>	Keeps the original aspect ratio in a full screen display.
<b>Original</b>	Keeps the original aspect ratio and size.
<b>Full</b>	An image fully fills the screen.

# Connecting a PC

## Connecting a PC

### HDMI connection

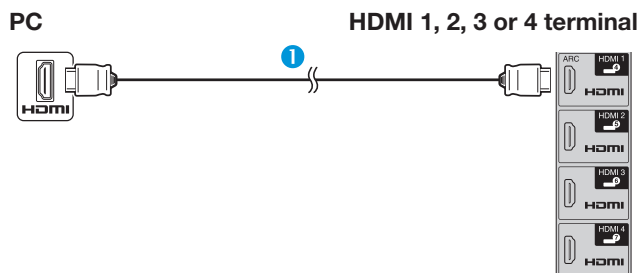

1 HDMI-certified cable (commercially available)

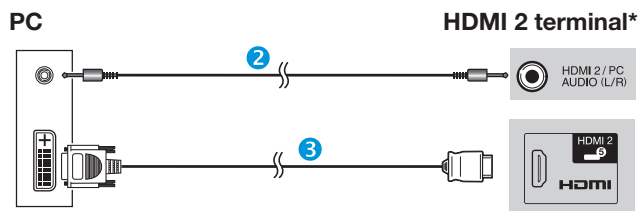

2 ø 3.5 mm stereo minijack cable (commercially available)

3 DVI/HDMI cable (commercially available)

\* When using the HDMI 2 terminal, you must select the proper item in the "Audio select" menu depending on the type of HDMI cable connected (refer to page 41 for details).

### Analogue connection

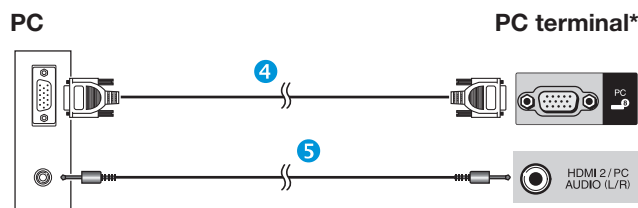

4 RGB cable (commercially available)

5 ø 3.5 mm stereo minijack cable (commercially available)

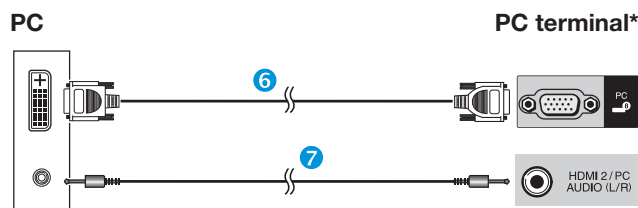

6 DVI/RGB conversion cable (commercially available)

7 ø 3.5 mm stereo minijack cable (commercially available)

\* When using the PC terminal, you must select "Video+Audio" in the "Audio select" menu (refer to page 41 for details).

### NOTE

- The PC input terminals are DDC 2B-compatible.
- Refer to page 54 for a list of PC signals compatible with the TV.

## Displaying a PC image on the TV

### Selecting the picture size

You can select the picture size.

- 1 Press **[Home]**.
  - The "Wide mode" menu displays.
- 2 Press **[Left]** or **[Up/Down]** to select the desired item.

### EXAMPLE

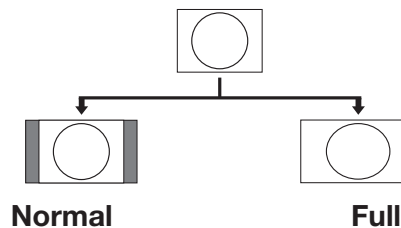

Item	
<b>Normal</b>	Keeps the original aspect ratio in a full screen display.
<b>Cinema</b>	For letterbox pictures. Bars may appear on the top and bottom with some programmes.
<b>Full</b>	An image fully fills the screen.
<b>Dot by Dot</b>	Displays an image with the same number of pixels on the screen.

### NOTE

- You can also select an item from the "Wide mode" menu (Page 40).
- Connect the PC before making adjustments.
- Selectable picture size may vary with input signal type.
- You may not be able to change the wide mode while in 3D mode.
- Refer to page 40 for AV signals.  
HDMI: 480i/480p/576i/576p/720p/1080i/1080p
- The PC terminal is not compatible with 480i/576i/1080p signals.

### Adjusting the PC image automatically

#### Option Auto sync.

This function enables the screen to be automatically adjusted to its best possible condition when the analogue terminals of the TV and PC are connected with a commercially available DVI/RGB conversion cable, etc.

- 1 Press  to select "PC" from the "INPUT" menu, and then press **OK**.
- 2 Go to "HOME" > "TV Menu" > "Setup" > "Option" > "Terminal setting" > "PC signal setting" > "Auto sync."





#### NOTE

- When "Auto sync." is successful, "Auto Sync completed successfully" displays. If not, "Auto sync." failed.
- "Auto sync." may fail even if "Auto Sync completed successfully" displays.
- "Auto sync." may fail if the PC image has low resolution, has unclear (black) edges, or is moved while executing "Auto sync."
- Be sure to connect the PC to the TV and switch it on before starting "Auto sync."
- "Auto sync." can be executed only when inputting analogue signals through the PC terminal.
- This function is available for 3D images converted from 2D images or normal 2D images.

### Adjusting the PC image manually



#### Option Fine sync.

Ordinarily you can easily adjust the picture as necessary to change image position using "Auto sync.". In some cases, however, manual adjustment is needed to optimise the image.

- 1 Press  to select "PC" from the "INPUT" menu, and then press **OK**.
- 2 Go to "HOME" > "TV Menu" > "Setup" > "Option" > "Terminal setting" > "PC signal setting" > "Fine sync."
- 3 Press  /  to select the specific adjustment item.
- 4 Press  /  to adjust the item to the desired position.

Item	
<b>H-Pos.</b>	Centres the image by moving it to the left or right.
<b>V-Pos.</b>	Centres the image by moving it up or down.
<b>Clock</b>	Adjusts when the image flickers with vertical stripes.
<b>Phase</b>	Adjusts when characters have low contrast or when the image flickers.

#### NOTE

- For resetting all adjustment items to the factory preset values, press  /  to select "Reset", and then press **OK**.
- "Clock" and "Phase" in the "Fine sync." menu can be adjusted only when inputting analogue signals through the PC terminal.
- This function is available for 3D images converted from 2D images or normal 2D images.

## Connecting a PC

### PC compatibility chart

Resolution	Horizontal frequency	Vertical frequency	Analogue (D-Sub)	Digital (HDMI)	VESA standard	
VGA	640 x 480	31.5 kHz	60 Hz	✓	✓	✓
SVGA	800 x 600	37.9 kHz	60 Hz	✓	✓	✓
XGA	1,024 x 768	48.4 kHz	60 Hz	✓	✓	✓
WXGA	1,360 x 768	47.7 kHz	60 Hz	✓	✓	✓
SXGA	1,280 x 1,024	64.0 kHz	60 Hz	✓	✓	✓
SXGA+	1,400 x 1,050	65.3 kHz	60 Hz	✓	✓	✓
UXGA	1,600 x 1,200	75.0 kHz	60 Hz	✓	✓	✓
1080p	1,920 x 1,080	67.5 kHz	60 Hz	✓	✓	

VGA, SVGA, XGA, WXGA, SXGA, SXGA+ and UXGA are registered trademarks of International Business Machines Corporation.

#### NOTE

- This TV has only limited PC compatibility, correct operation can only be guaranteed if the video card conforms exactly to the VESA 60 Hz standard. Any variations from this standard will result in picture distortions.



## Connecting a PC

### PC control of the TV

- When a programme is set, the TV can be controlled from the PC using RS-232C or IP. The input signal (PC/video) can be selected, the volume can be adjusted and various other adjustments and settings can be made, enabling automatic programmed playing.
- Use an RS-232C serial control cable (cross type), ETHERNET cable (commercially available) or wireless LAN USB adapter for the connections.

#### NOTE

- This operation system should be used by a person who is accustomed to using PCs.

### Communication conditions for IP

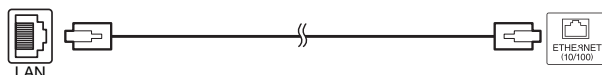

ETHERNET cable (commercially available)

Connect to the TV with the following settings made for IP on the PC.

<b>IP protocol</b>	TCP/IP
<b>Host IP address</b>	Set the IP address on the TV menu
<b>Service</b>	None (Do not select Telnet or SSH)
<b>TCP port#</b>	Set a port number on the TV menu (Control port)

When you set your ID and password on the TV menu, you need to enter them as soon as you connect to the TV.

#### NOTE

- The connection will be cut off when there has been no communication for 3 minutes.

### IP Control setup

- Go to "HOME" > "IP Control" > select "Change".
- To use IP Control, select "Enable".
- Set the device name.
- Set your login ID and password.
- Set the port to use with IP Control.
- Confirm the settings, and then press "OK".

### Communication conditions for RS-232C

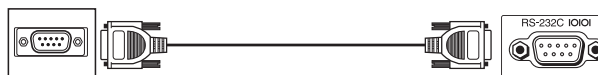

RS-232C serial control cable (cross type)  
(commercially available)

Set the RS-232C communications settings on the PC to match the TV's communications conditions. The TV's communications settings are as follows:

<b>Baud rate</b>	9,600 bps
<b>Data length</b>	8 bits
<b>Parity bit</b>	None
<b>Stop bit</b>	1 bit
<b>Flow control</b>	None

### Communication procedure

Send the control commands from the PC via the RS-232C connector.

The TV operates according to the received command and sends a response message to the PC.

Do not send multiple commands at the same time. Wait until the PC receives the OK response before sending the next command. Make sure to send "A" with the carriage return and confirm that "ERR" returns before operating.

### Command format

Eight ASCII codes +CR

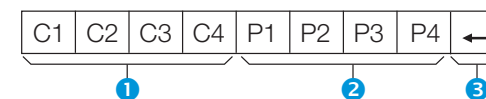

- Command four digits: Command. The text of four characters.
- Parameter four digits: Parameter 0-9, blank, ?, minus
- Return code (0DH): ↵

### Parameter

Input the parameter values, aligning left, and fill with blank(s) for the remainder (be sure that four values are input for the parameter).

When the input parameter is not within an adjustable range, "ERR" returns (refer to "Response code format").

0			
0	0	0	9
1	0	0	
0	0	5	5

When "?" is input for some commands, the present setting value responds.

?	?	?	?
---	---	---	---

### Response code format

Normal response



Return code (0DH)

Problem response  
(communication error or incorrect command)



Return code (0DH)

## Command list

CONTROL ITEM	COMMAND	PARAMETER	CONTROL CONTENTS
POWER SETTING	P O W R 0	_ _ _	POWER OFF (STANDBY)
INPUT SELECTION A	I T G D	_ _ _	INPUT SWITCHING (TOGGLE)
	I T V D	_ _ _	TV (CHANNEL FIXED)
	I D T V	_ _ _	DTV (CHANNEL FIXED)
	I A V D	* _ _	EXT 1-3 (1-3), HDMI 1-4 (4-7), PC (8)
CHANNEL	D C C H	* * _	TV DIRECT CHANNEL (1-99)
	C H U P	_ _ _	CHANNEL UP
	C H D W	_ _ _	CHANNEL DOWN
	D T V D	* * * _	THREE DIGIT DIRECT CHANNEL (1-999) (Non-Nordic countries)
	D T V D	* * * *	FOUR DIGIT DIRECT CHANNEL (1-9999) (Nordic countries only)*1
	I D E G	_ _ _	DIGITAL NETWORK CHANGE*1
	D S C 1	* * * *	DVB-S/S2 1 DIRECT CHANNEL (1-9999)*1
	D S C 2	* * * *	DVB-S/S2 2 DIRECT CHANNEL (1-9999)*1
	D S C 3	* * * *	DVB-S/S2 3 DIRECT CHANNEL (1-9999)*1
	D S C 4	* * * *	DVB-S/S2 4 DIRECT CHANNEL (1-9999)*1
INPUT SELECTION B	D T U P	_ _ _	DTV CHANNEL UP
	D T D W	_ _ _	DTV CHANNEL DOWN
	I N P 1 0	_ _ _	EXT 1 (Y/C)
	I N P 1 1	_ _ _	EXT 1 (CVBS)
	I N P 1 2	_ _ _	EXT 1 (RGB)

CONTROL ITEM	COMMAND	PARAMETER	CONTROL CONTENTS
AV MODE SELECTION	A V M D 0	_ _ _	TOGGLE
	A V M D 1	_ _ _	STANDARD
	A V M D 2	_ _ _	MOVIE
	A V M D 3	_ _ _	GAME
	A V M D 4	_ _ _	USER
	A V M D 5	_ _ _	DYNAMIC (Fixed)
	A V M D 6	_ _ _	DYNAMIC
	A V M D 7	_ _ _	PC
	A V M D 1 4	_ _	STANDARD (3D)*2
	A V M D 1 5	_ _	MOVIE (3D)*2
	A V M D 1 6	_ _	GAME (3D)*2
	A V M D 1 0 0	_	AUTO
	VOLUME	V O L M	* * _
POSITION	H P O S	* * * _	H-POSITION (AV/PC)
	V P O S	* * * _	V-POSITION (AV/PC)
	C L C K	* * * _	CLOCK (0-180)
	P H S E	* * _	PHASE (0-40)
WIDE MODE	W I D E 0	_ _ _	TOGGLE (AV)
	W I D E 1	_ _ _	NORMAL (AV)
	W I D E 2	_ _ _	ZOOM 14:9 (AV)
	W I D E 3	_ _ _	PANORAMA (AV)
	W I D E 4	_ _ _	FULL (AV/USB-Video/ Home network-Video)
	W I D E 5	_ _ _	CINEMA 16:9 (AV)
	W I D E 6	_ _ _	CINEMA 14:9 (AV)
	W I D E 7	_ _ _	NORMAL (PC)
	W I D E 8	_ _ _	CINEMA (PC)
	W I D E 9	_ _ _	FULL (PC)
	W I D E 1 0	_ _	DOT by DOT (AV/PC)
	W I D E 1 1	_ _	UNDERSCAN (AV)
	W I D E 1 2	_ _	AUTO (USB-Video/ Home network-Video)
W I D E 1 3	_ _	ORIGINAL (USB-Video/Home network-Video)	
MUTE	M U T E 0	_ _ _	TOGGLE
	M U T E 1	_ _ _	MUTE
	M U T E 2	_ _ _	MUTE OFF

CONTROL ITEM	COMMAND	PARAMETER	CONTROL CONTENTS
SURROUND	A C S U 0	_ _ _	SURROUND TOGGLE
	A C S U 1	_ _ _	SURROUND ON
	A C S U 2	_ _ _	SURROUND OFF
	A C S U 4	_ _ _	SURROUND 3D HALL
	A C S U 5	_ _ _	SURROUND 3D MOVIE
	A C S U 6	_ _ _	SURROUND 3D STANDARD
AUDIO CHANGE	A C H A	_ _ _	TOGGLE
SLEEP TIMER	O F T M 0	_ _ _	OFF
	O F T M 1	_ _ _	SLEEP TIMER 30 MIN
	O F T M 2	_ _ _	SLEEP TIMER 1 HOUR
	O F T M 3	_ _ _	SLEEP TIMER 1 HOUR 30 MIN
	O F T M 4	_ _ _	SLEEP TIMER 2 HOUR
	O F T M 5	_ _ _	SLEEP TIMER 2 HOUR 30 MIN
TELETEXT	T E X T 0	_ _ _	TELETEXT OFF
	T E X T 1	_ _ _	TELETEXT ON (TOGGLE)
	D C P G	* * * _	DIRECT PAGE JUMP (100-899)
3D	T D C H 0	_ _ _	3D OFF
	T D C H 1	_ _ _	2D → 3D
	T D C H 2	_ _ _	SIDE BY SIDE
	T D C H 3	_ _ _	TOP AND BOTTOM
	T D C H 4	_ _ _	3D → 2D (SIDE BY SIDE)
	T D C H 5	_ _ _	3D → 2D (TOP AND BOTTOM)
	T D C H 6	_ _ _	3D AUTO
	T D C H 7	_ _ _	3D → 2D*2
DEVICE NAME	T V N M 1	_ _ _	DISPLAY THE DEVICE NAME
MODEL NAME	M N R D 1	_ _ _	DISPLAY THE MODEL NAME
SOFTWARE VERSION	S W V N 1	_ _ _	DISPLAY THE SOFTWARE VERSION
IP PROTOCOL VERSION	I P P Y 1	_ _ _	DISPLAY THE IP PROTOCOL VERSION

\*1 740 series only

\*2 These commands are available only during 3D mode.

# Network setup

## Connecting to the network

To enjoy internet services, you need to connect the TV to a router with a high speed connection to the internet. You can also connect the TV to your Home network server through a router or access point. The TV connection to the router can either be wired or wireless.

### NOTE

- If you choose a wired connection to the router, you need an ETHERNET cable (commercially available).
- If you do not have a broadband internet connection, consult the store where you purchased your TV or ask your internet service provider or telephone company.
- An Ethernet and wireless connection cannot be used at the same time. Use only one of the connection types.
- A wireless LAN connection and performance cannot be guaranteed for all residential environments. In the following cases, the wireless LAN signal may be poor or drop, or the connection speed may become slower.
  - When used in buildings made with concrete, reinforced steel, or metal
  - When placed near objects that obstruct the signal
  - When used with other wireless devices that emit the same frequency
  - When used in the vicinity of microwave ovens and other devices that emit a magnetic field, electrostatic charge, or electromagnetic interference
- A stable connection speed is required to play back streaming content. Use an Ethernet connection if the wireless LAN speed is unstable.

## Wired installation

Use an ETHERNET cable to connect the ETHERNET terminal on the TV to your broadcast router as shown below. This is recommended when enjoying services which require stable connection speeds, such as streaming media.

### ● Wired connection overview

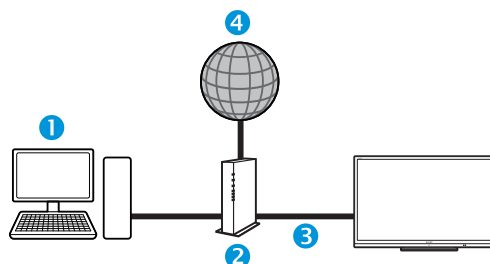

- 1 PC
- 2 Router (commercially available)
- 3 ETHERNET cable (commercially available)
- 4 Network

### ● How to connect

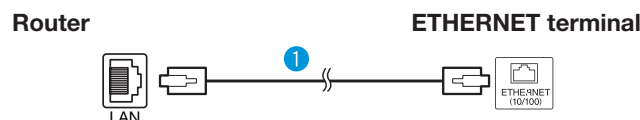

- 1 ETHERNET cable (commercially available)
- 1 Switch on the router (commercially available). Refer to the router's operation manual for switching on.
- 2 Connect the ETHERNET terminal on the TV to the router (commercially available) with an ETHERNET cable (commercially available).
- 3 Go to "HOME" > "Network setup" > "Auto setup", and then press **OK**.

- 4 Press **▲/▼** to select "Wired", and then press **OK**.
- 5 Confirm the message on the screen and then press **OK** to go to the next step.
- 6 Perform "Connection test" after the connection is completed. Press **◀/▶** to select "Yes", and then press **OK**.
- 7 The connection test result will be displayed on the screen. Follow the on-screen instructions for the settings after this step.
  - If you want to change the IP settings manually, go to "HOME" > "Network setup" > "Manual setup" > "IP setup" and follow the on-screen instructions and the operation manual of the router.

## Network setup

### Wireless installation

Use the wireless LAN USB adapter supplied with the TV.

#### ● Wireless connection overview

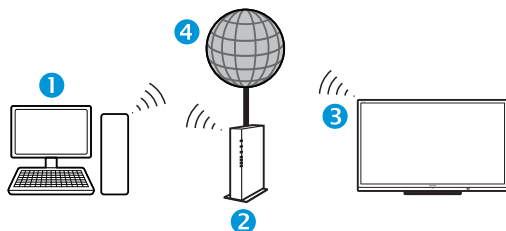

- 1 PC
- 2 Wireless LAN router/access point
- 3 Wireless LAN USB adapter (supplied)
- 4 Network

#### NOTE

- When using the SHARP wireless LAN USB adapter (supplied), try to provide as much free space around the device for best performance.
- Make sure the firewalls in your network allows access to the TV wireless connection.
- Operations cannot be guaranteed when used with access points that do not have Wi-Fi® certification.
- A wireless LAN access point is required to connect the TV to the Internet using a wireless LAN. See the operation manual of your access point for setup.

#### ● How to connect

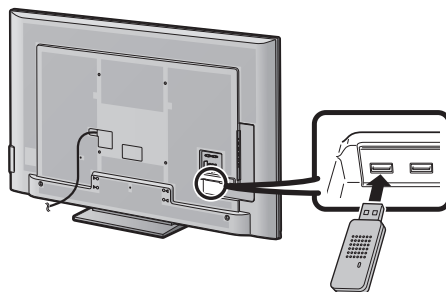

- 1 Switch on your router before starting the network installation.
- 2 Connect the wireless LAN USB adapter (supplied) to the USB 3 (WIRELESS LAN) port on the rear of the TV.
  - Do not use a wireless LAN adapter other than the supplied SHARP wireless LAN adapter, as operations cannot be guaranteed.
- 3 Go to “HOME” > “Network setup” > “Auto setup”, and then press **OK**.  
**NOTE**
  - Follow the on-screen instructions when setting manually.  
Go to “HOME” > “Network setup” > “Manual setup”.
- 4 Press **▲/▼** to select “Wireless”, and then press **OK**.
- 5 Confirm the WPS location and then press **OK** to go to the next step.
- 6 Perform “Connection test” after the connection is completed. Press **◀/▶** to select “Yes”, and then press **OK**.
- 7 The connection test result will be displayed on the screen. Follow the on-screen instructions for the settings after this step.

#### NOTE

- When not using “Push button”, perform the settings from “HOME” > “Network setup” > “Manual setup” > “Connection type”.
- To connect your TV to the internet, you must have a broadband internet connection.
- If you do not have a broadband internet connection, consult the store where you purchased your TV or ask your internet service provider or telephone company.
- There is no need to enter the security key for subsequent connections to the wireless network.
- If your access point is set to a stealth mode (that prevents detection by other devices), you may not be able to establish a connection. In this case, disable the stealth mode on the access point.
- If you want to change the IP settings manually, go to “HOME” > “Network setup” > “Manual setup” > “IP setup” and follow the on-screen instructions and the operation manual of the router.
- See page 73 to check the supplied SHARP wireless LAN adapter specifications.

# Net TV

## What is Net TV?

Net TV offers internet service and websites tailored for your TV. Use the TV remote control unit to browse the Net TV internet pages. Net TV allows you to play movies, view pictures, listen to music, play games, rent a movie from a video store\* and much more. Net TV provides variety of services for each country. You can browse other countries' service as well. If a service is unsuitable for children, you can lock it as needed.

\* Video store can only be used with country-exclusive special Net TV services.

### NOTE

- Because Net TV is an online system, it can be modified over time to better serve its purpose.
- Some Net TV services may be added, changed or discontinued after some time.
- Some open internet websites may not be tailored for a TV screen and may not be displayed correctly.
- You cannot download and save files nor install plug-ins.

### DISCLAIMERS

- SHARP corporation bears no responsibility regarding the content and quality of the content provided by the content serve provider.

## Operations in Net TV

### Basic operation

The illustrations on this page are for explanation purposes. They are subject to change without notice.

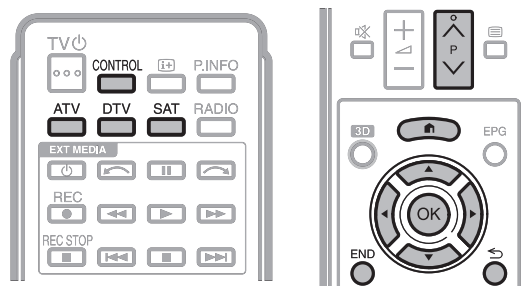

### ● Display the start page

Go to "HOME" > "AQUOS NET+".

### NOTE

- When switching to Net TV, a message which requests a software update may display in some cases.

### ● Select a service

Press  $\blacktriangle$ / $\blacktriangledown$ / $\blacktriangleleft$ / $\blacktriangleright$  to select the desired service, and then press **OK**.

- Press **P**  $\wedge$ / $\vee$  to scroll pages up/down (This may not function for some services).
- Press  $\leftarrow$  to return to the previous page (This may not function for some services).
- Press **END** to return to the Net TV start page.

### ● Exit Net TV

Press **ATV/DTV/SAT**.

- You can exit from Net TV by pressing  $\rightarrow$  and select another input source.

## Option menu

Press **CONTROL** and the option menu displays. Press  $\blacktriangle$ / $\blacktriangledown$  to select the desired menu item, and then press **OK**.

### ● User setting

Changes some settings, such as lock/unlock the service, for Net TV.

### NOTE

- This may not function for some services.

- 1 Select "User setting", and then press **OK**.
- 2 Press  $\blacktriangle$ / $\blacktriangledown$ / $\blacktriangleleft$ / $\blacktriangleright$  to select the desired operation, and then press **OK**.

### ● Control panel

Displays an on-screen control panel for watching online contents.

- 1 Select "Control panel", and then press **OK**.
- 2 Press  $\blacktriangle$ / $\blacktriangledown$ / $\blacktriangleleft$ / $\blacktriangleright$  to select the desired operation, and then press **OK**.
- 3 Press **END** to exit.

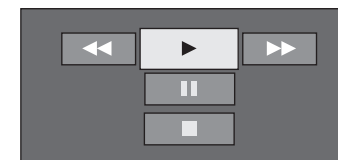

Buttons	Description
$\blacktriangleright$	Playback
$\blacksquare$	Stop
$\text{  }$	Pause
$\blacktriangleright\blacktriangleright$	Fast forward
$\blacktriangleleft\blacktriangleleft$	Reverse

### NOTE

- These operations can also be done by pressing the corresponding buttons ( $\blacktriangleright$ / $\blacksquare$ / $\text{||}$ / $\blacktriangleright\blacktriangleright$ / $\blacktriangleleft\blacktriangleleft$ ) on the remote control unit.
- The control panel may not function on some services.

### ● Reload

Refreshes the page you are browsing. If an error occurs while loading the page, execute this function and reload it.

Select “Reload”, and then press **OK**.

### ● Zoom

Adjusts the display size of the page you are browsing.



- 1 Select “Zoom”, and then press **OK**.
- 2 Press ◀/▶ to adjust the display size.
- 3 Press **END** to exit.

### ● Security info.

Shows information regarding the security of the page you are browsing.

- 1 Select “Security info.”, and then press **OK**.
- 2 Select “**OK**” or press **END** to exit.

## Inputting texts

Use the software keyboard (Page 13) when you need to input text.

## Clear Net TV memory

You can clear the Net TV memory, which includes the lock code, passwords, cookies and browsing history.

Go to “HOME” > “TV Menu” > “Setup” > “View setting” > “Net TV setting” > “Clear Net TV memory”.

### NOTE

- PIN input is required when executing “Clear Net TV memory”. The default PIN is “1234”. To change the PIN setting, refer to **Individual setting — PIN** (Page 38). To reset the PIN setting (PIN input will no longer be needed), refer to **Reset the PIN** (Page 67).
- This function is available only while browsing Net TV.

### CAUTION

- If you exercise this operation, Net TV will be completely initialized. If there is important information for you, take notes before executing.

## Video store

You can enjoy watching your favourite movies from an online rental video store with Net TV.

### NOTE

- Video store can only be used with country-exclusive special Net TV services.

## SD card

An SD memory card (commercially available) is required to rent and download a video from the video store. Be sure to use an SDHC (High capacity) card with a minimum of 4 GB memory (Class 6 is recommended).

- 1 Insert the SD card into the SD CARD (VIDEO STORE) slot.
- 2 The TV automatically starts formatting the SD card.
- 3 Leave the card in the slot when finished formatting.

### NOTE

- A high-speed internet connection to the TV is also required to rent and download a video.
- For HD movies, a minimum of 8 GB memory will be needed.
- The TV could reject the SD card if the write speed is insufficient for video transfer.
- SD cards are sold separately.
- Some SD cards may not work properly for this function.

## Rent and download a video

With Net TV, you can rent a video from “Video store”. In most cases, you can rent a video for 1 day, for a couple of days, or just 1 hour.

- 1 Select the desired video store service and press **OK**.
- 2 Select the desired item on the video store page and press **OK**.
  - The procedure to select and rent a video varies according to store.
- 3 Make the online payment.
  - The store will ask you to login or create a new account if you don't have one. The login might consist of your e-mail address and PIN code.
- 4 Download the video.
  - During the download, you can continue watching normal programmes until the TV notifies you that the download is completed.
- 5 With your login, select the store where you rented the video and press **OK**.
- 6 Select the rented video and press **OK** to play.

### NOTE

- This service is exclusive to some areas.
- When you are creating the account, you can choose the payment method. Consult each video store website for more information on the payment terms.
- To enter a number code (PIN), use the numbers on the remote control.
- To enter an e-mail address, select the text field on the page and press **OK**. Select a character on the keyboard and press **OK** to enter it.
- Even if a download has been cancelled, the video can still be downloaded until the rental period expires.
- Register an SD card using the following procedure when the screen prompt pops up:  
Go to “HOME” > “TV Menu” > “Setup” > “View setting” > “Net TV setting” > “SD card registration”.

## Enjoying 3D image viewing

---

You can enjoy 3D-supported images on this TV when you wear 3D glasses (AN-3DG20), sold separately.

To produce 3D images, liquid crystal shutters in the 3D glasses alternately open and close imperceptibly fast to exactly match alternating left and right video images displayed by the TV.

### NOTE



- Refer to the operation manual of the 3D glasses for details regarding usage.
- Some menu items are greyed out in 3D mode. This is not a malfunction.

### CAUTION

- Not all consumers can experience and enjoy 3D TV. Some people suffer from stereo blindness which prevents them from perceiving the intended depth of 3D entertainment. Also, some people who watch 3D programming may experience initial feelings of motion sickness as they adjust to the picture. Others may experience headaches, eye fatigue or continued motion sickness, or some viewers might also experience epileptic seizures or strokes. Like a roller coaster, the experience is not for everyone.
- The 3D glasses are precision equipment. Handle them with care.
- Improper use of the 3D glasses or failure to follow these instructions can result in eye strain.
- If you experience dizziness, nausea, or other discomfort while viewing 3D images, immediately discontinue use of the 3D glasses. Using the binocular disparity 3D system of the TV with incompatible 3D broadcasts or software can make images appear with a cross talk blur or create overlapping images.
- When viewing 3D images continuously, be sure to take a break periodically to prevent eye strain.
- If you are nearsighted or farsighted or have astigmatism or a different level of eyesight between the left and right eyes, you should take the necessary steps, such as wearing eyeglasses, to correct your eyesight before viewing 3D images. The 3D glasses can be worn over eyeglasses.
- When viewing 3D images, keep the 3D glasses horizontally level with the TV screen. If you tilt the 3D glasses with respect to the TV screen, the images viewed by the left and right eyes may appear significantly different or images may appear overlapping.
- View 3D images at the appropriate distance from the TV screen. The recommended distance is three times the effective height of the TV screen.
- Be careful of your surroundings when viewing 3D images. When you view 3D images, objects may appear at a distance closer or farther than the actual TV screen. This may cause you to misjudge the distance to the TV screen and possibly result in injury if you accidentally hit the screen or surrounding objects.
- The 3D glasses are not recommended for people aged less than 6.
- When children are viewing 3D images, be sure a parent or guardian is present. Monitor children viewing 3D images, and if they show signs of discomfort, immediately discontinue use of the 3D glasses.
- People with a known history of photosensitivity and people with heart problems or poor health should not use the 3D glasses. This can worsen existing health conditions.
- Do not use the 3D glasses for other purposes (such as general eyeglasses, sunglasses, or protective goggles).

- Do not use the 3D function or 3D glasses while walking or moving around. This may result in injuries due to running into objects, tripping, and/or falling.
- When using the 3D glasses, take care not to accidentally strike the TV screen or other people. Viewing 3D images may cause you to misjudge the distance to the TV screen and accidentally strike the screen, resulting in possible injury.
- It is recommended that you do not view 3D images if you are sleep deprived or if you have been drinking alcohol.

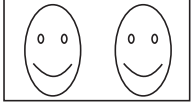
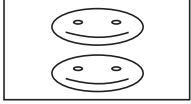
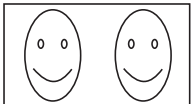
### Display format for 3D and 2D images

	Image for input signals	Selectable mode	Description
<b>3D mode (using the 3D glasses)</b>		2D → 3D	<ul style="list-style-type: none"> <li>Converts normal 2D images into 3D images.</li> </ul>
		Side by Side	<ul style="list-style-type: none"> <li>Creates 3D images from 3D images displayed side by side. The image is split into a left and right image, and then the images are stretched and displayed sequentially to create a 3D image.</li> </ul>
		Top and Bottom	<ul style="list-style-type: none"> <li>Creates 3D images from 3D images displayed on the top and bottom. The image is split into a top and bottom image, and then the images are stretched and displayed sequentially to create a 3D image.</li> </ul>
<b>2D mode (without using the 3D glasses)</b>		Side by Side → 2D	<ul style="list-style-type: none"> <li>Creates 2D images from 3D images displayed side by side. Only the left image is stretched and displayed. The image does not appear in 3D.</li> </ul>
		Top and Bottom → 2D	<ul style="list-style-type: none"> <li>Creates 2D images from 3D images displayed on the top and bottom. Only the top image is stretched and displayed. The image does not appear in 3D.</li> </ul>



### Viewing 3D images

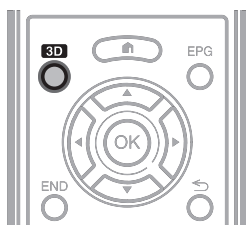

#### NOTE

- Refer to the operation manual of the 3D glasses for details regarding usage.
- The TV screen may temporarily become black when the TV is trying to detect a 3D image signal and when switching from 3D to 2D mode.

### Receiving a 3D image signal that can be detected automatically

The image signal may contain a 3D identification signal. You can enable the TV to automatically detect the 3D image type (Page 62).

- 1 Go to “HOME” > “TV Menu” > “Setup” > “Option” > “3D setup” > “3D auto change”.
- When “3D auto change” is set to “Yes”
    - The 3D display format is detected automatically and the appropriate 3D image is displayed.



- When “3D auto change” is set to “No”

- ① The confirmation message is displayed. Press **3D**.
- ② Press ◀/▶ to select “Yes”, and then press **OK**.

- 2 Turn on the power of the 3D glasses, and then wear the 3D glasses.

#### NOTE

- If you do not want to switch to 3D mode automatically, set “3D auto change” to “No”.
- When the TV is receiving a 3D image signal that can be detected automatically, the 3D mode icon is displayed in the channel display.

### Switching 3D to 2D mode

When you press **3D** while you are watching the TV in 3D mode, the TV switches to 2D mode.

- 1 Press **3D** during the 3D mode.
- 2 Select “Yes”, and then press **OK** to switch to 2D mode.
- 3 Take off the 3D glasses and turn off the power of the 3D glasses.

#### NOTE

- If the input signal switches to 2D, 2D images are displayed automatically.
- 3D mode is canceled automatically when the setting is changed, input source is changed, the input signal resolution is changed or the power is turned off.

### Receiving a 3D image signal that cannot be detected automatically

When the TV receives a 3D image signal that cannot be detected automatically, you can select between 3D and 2D image viewing.

- 1 Press **3D**.
  - A screen appears prompting you to select between 3D and 2D image viewing.



- 2 Press ◀/▶ to select “3D” or “2D”, and then press **OK**.

#### To view in 3D mode

- ① Press ◀/▶ to select the 3D signal type (“2D → 3D”, “Side by Side” or “Top and Bottom”), and then press **OK**.

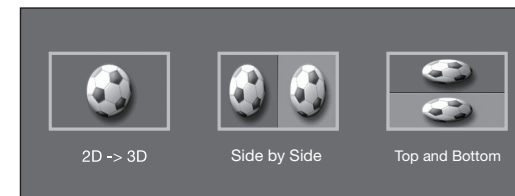

- If you select the same system as that of the input signal, 3D images are displayed.
- You can select only “2D → 3D” in ATV mode.
- ② Turn on the power of the 3D glasses, and then wear the 3D glasses.

#### To view in 2D mode

- Switching from 3D to 2D mode.

Press ◀/▶ to select the 2D signal type (“Side by Side” or “Top and Bottom”), and then press **OK**.

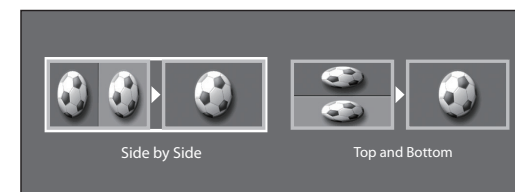

- If you select the same system as that of the input signal, 2D images are displayed.

## Enjoying 3D image viewing

### Watching 2D images in 3D

You can convert normal 2D images into 3D images.

- 1 Press **3D**.
- 2 Press **◀/▶** to select “2D → 3D”, and then press **OK**.
- 3 Turn on the power of the 3D glasses, and then wear the 3D glasses.

#### NOTE

- The confirmation message to select either 3D or 2D mode is displayed on the screen once per hour.
- When the TV converts normal 2D images into 3D images, you can display the “2D → 3D convert effect” menu to adjust the convert effect by pressing **Y**.

### Switching to the previous mode

You can switch back to the previous mode by pressing **3D**.

- 1 Press **3D**.
  - A confirmation message is displayed.
- 2 Select “Yes”, and then press **OK**.
  - The TV returns to the previous mode.

### 3D Menu

Pressing **3D** in 3D mode displays the 3D menu. Press the coloured buttons to make the necessary settings.

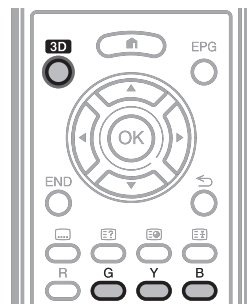

Buttons	Description
<b>G button</b>	Surround (Page 33). <ul style="list-style-type: none"> <li>• The surround mode changes each time you press <b>G</b>.</li> </ul>
<b>Y button</b>	2D → 3D convert effect (Page 65). <ul style="list-style-type: none"> <li>• “2D → 3D convert effect” is available only when selecting “2D → 3D” (refer to <b>Watching 2D images in 3D</b> shown to the left).</li> </ul>
<b>B button</b>	3D setup (Page 65).

### Configuring the TV settings to enhance 3D image viewing

You can make various settings to enhance 3D image viewing.



### 3D picture adjustments

#### ● Basic operation

Go to “HOME” > “TV Menu” > “Setup” > “Picture” > select/adjust the item you want to set.

#### NOTE

- Which items can be selected/adjusted differs depending on whether the TV is in 2D mode or in 3D mode.

#### AV mode

The audio and video settings can be changed to suit the programme or input content being watched.

Item	
<b>STANDARD (3D)</b>	For a highly defined image in a normal lighting.
<b>MOVIE (3D)</b>	For a movie.
<b>GAME (3D)</b>	Lowers image brightness for easier viewing.

#### NOTE

- You can select “AV mode” by pressing **AV MODE** on the remote control unit.

## Enjoying 3D image viewing

### 3D setup

#### ● Basic operation

Go to “HOME” > “TV Menu” > “Setup” > “Option” > “3D setup” > select the menu you want to set.

#### 3D auto change

This function allows the TV to switch to 3D mode automatically when a 3D identification signal is detected.

Item	
Yes	When a 3D signal is detected, the TV switches to 3D mode automatically.
No	Automatic change is not performed.

#### NOTE

- 3D signals may not be detected depending on the signal format.

#### 2D → 3D convert effect

You can adjust the 3D effect when converting images from 2D mode to 3D mode. Select a desired level of convert effect from +1 to +16.

#### NOTE

- This function is only available when converting 2D images to 3D images.
- When you use this function, image conversion on the TV will result in some differences in the original images and how they appear.
- 2D images that have been converted to 3D images may be viewed only for personal use.

### 3D still image effect setting

Select the method for adjusting the 3D image effect (depth).

Item	
Auto	Adjusts the still image effect (depth) automatically.
Manual	For manual adjustment of the still image effect (depth).

#### NOTE

- If you select “Manual”, adjust the 3D still image effect (depth) with “3D still image effect adjustment”.
- This function can be adjusted when viewing 3D still images in USB media mode.
- Even if you select “Auto”, the 3D still image effect (depth) may not be correctly adjusted depending on the 3D still image.
- 3D still images taken in macro mode will be displayed with excessive depth.
- If you experience discomfort while viewing 3D images, immediately discontinue viewing.

### 3D still image effect adjustment

You can adjust the 3D still image effect (depth). Adjust the level from -5 to +10. “0” is the level where no adjustment is made (factory preset value).

#### NOTE

- This function can be adjusted when viewing 3D still images in USB media mode.
- If you experience discomfort while viewing 3D images, immediately discontinue viewing.

### Viewing time info

This function allows you to display the elapsed time of 3D image viewing on the screen.

Item	
Yes	The elapsed time is displayed in one-hour increments after you start watching 3D images.
No	Hide the time.

### 3D test

This function displays 3D images for testing the 3D operation. Clicking “Start” on the screen plays back 3D test images.



#### NOTE

- If you press **END** during playback, the previous screen will be displayed.

### 3D glasses control

To enable this function, set the location of the TV to “STORE” (Page 14). Selecting “Yes” prevents the 3D glasses from receiving 3D signals from other TVs.

### Troubleshooting — 3D Images

Problem	Possible solution
<ul style="list-style-type: none"> <li>3D images are not displayed.</li> </ul>	<ul style="list-style-type: none"> <li>Is “3D auto change” set to “No”? Press <b>3D</b> to switch to 3D mode (Page 63).</li> <li>If “3D auto change” is set to “Yes” but no 3D images are displayed, check the display format of the content being viewed. Some 3D image signals may not be recognized as 3D images automatically. Press <b>3D</b> to select the appropriate display format for the 3D image (Page 63).</li> <li>Is the power of the 3D glasses turned on? Slide the switch for the 3D glasses to 3D to turn on the 3D glasses.</li> <li>Are the 3D glasses set to 2D mode? Slide the switch for the 3D glasses to 3D.</li> <li>Is there an obstacle between the 3D glasses and the TV, or is something covering the infrared receiver on the 3D glasses? The 3D glasses operate by receiving a signal from the TV. Do not place anything between the 3D infrared emitter on the TV and the infrared receiver on the 3D glasses.</li> </ul>
<ul style="list-style-type: none"> <li>Images displayed in 3D mode appear doubled while you are wearing the 3D glasses.</li> </ul> 	<ul style="list-style-type: none"> <li>Is the power of the 3D glasses turned on? Slide the switch for the 3D glasses to 3D to turn on the 3D glasses.</li> </ul>
<ul style="list-style-type: none"> <li>Images displayed in 3D mode appear 2D while you are wearing the 3D glasses.</li> </ul> 	<ul style="list-style-type: none"> <li>Are the 3D glasses set to 2D mode? Slide the switch for the 3D glasses to 3D while viewing 2D images and the 2D images switch to 3D images.</li> </ul>

- For further details, refer to the operation manual of the 3D glasses.

#### 3D glasses lenses

- Do not apply pressure to the lenses of the 3D glasses. Also, do not drop or bend the 3D glasses.
- Do not scratch the surface of the lenses of the 3D glasses with a pointed instrument or other object. Doing so may damage the 3D glasses and reduce the quality of the 3D image.
- Use only the cloth provided with the 3D glasses to clean the lenses.

#### 3D glasses infrared receiver

- Do not allow the infrared receiver to become dirty, and do not attach stickers to or otherwise cover the infrared receiver. Doing so may prevent the receiver from operating normally.
- If the 3D glasses are affected by other infrared data communication equipment, the 3D images may not be displayed correctly.



#### Caution during viewing

- Do not use devices that emit strong electromagnetic waves (such as cellular phones or wireless transceivers) near the 3D glasses. Doing so may cause the 3D glasses to malfunction.
- The 3D glasses cannot operate fully at extreme high or low temperatures. Please use them within the specified usage temperature range.
- If the 3D glasses are used in a room with fluorescent lighting (50/60 Hz), the light within the room may appear to flicker. In this case, either darken or turn off the fluorescent lights when using the 3D glasses.
- Wear the 3D glasses correctly. 3D images will not be correctly visible if the 3D glasses are worn upside down or back-to-front.
- Other displays (such as computer screens, digital clocks, and calculators) may appear dark and difficult to view while wearing the 3D glasses. Do not wear the 3D glasses when watching anything other than 3D images.
- If you lie on your side while watching the TV with 3D glasses, the picture may look dark or may not be visible.
- Be sure to stay within the viewing angle and optimum TV viewing distance when watching 3D images. Otherwise, you may not be able to enjoy the full 3D effect.
- The 3D glasses may not work properly if there is any other 3D product or electronic devices turned on near the glasses or TV. If this occurs, turn off the other 3D product or electronic devices or keep the devices as far away as possible from the 3D glasses.
- Stop using this product in any of the following situations:
  - When images consistently appear doubled while you are wearing the 3D glasses
  - When you have difficulty perceiving the 3D effect
- If the 3D glasses are faulty or damaged, stop using them immediately. Continued use of the 3D glasses may cause eye fatigue, headaches and illness.
- If you have any abnormal skin reaction, stop using the 3D glasses. In very rare instances, such reactions may be due to an allergic reaction to the coating or materials used.
- If your nose or temples become red or you experience any pain or itchiness, stop using the 3D glasses. Pressure caused by long periods of use may lead to such reactions and may result in skin irritation.
- You may not be able to use several menu items while you are watching the TV in 3D mode.
- You cannot use the 3D function in radio or data mode.

#### NOTE





- These 3D glasses are only for use with SHARP LCD TVs supporting 3D.

## Troubleshooting

Problem	Possible solution
<ul style="list-style-type: none"> <li>No power.</li> </ul>	<ul style="list-style-type: none"> <li>Is the AC cord disconnected?</li> <li>Check if you pressed  on the TV.</li> </ul>
<ul style="list-style-type: none"> <li>The TV cannot be operated.</li> </ul>	<ul style="list-style-type: none"> <li>External influences such as lightning, static electricity, etc., may cause improper operation. In this case, operate the TV after first turning off the power, or unplugging the AC cord and re-plugging it in after one or two minutes.</li> </ul>
<ul style="list-style-type: none"> <li>Remote control unit does not operate.</li> </ul>	<ul style="list-style-type: none"> <li>Are batteries inserted with polarity (+, -) aligned?</li> <li>Are batteries worn out? (Replace with new batteries.)</li> <li>Are you using it under strong or fluorescent lighting?</li> <li>Is a fluorescent light illuminating to the remote control sensor?</li> </ul>
<ul style="list-style-type: none"> <li>Picture is cut off.</li> </ul>	<ul style="list-style-type: none"> <li>Is the image position correct?</li> <li>Are screen mode adjustments (Wide mode) such as picture size made correctly? (Pages 40, 51 and 52)</li> </ul>
<ul style="list-style-type: none"> <li>Strange colour, light colour, or dark colour, or colour misalignment.</li> </ul>	<ul style="list-style-type: none"> <li>Adjust the picture tone.</li> <li>Is the room too bright? The picture may look dark in a room that is too bright.</li> <li>Check the "Colour system" setting (Pages 37 and 42).</li> </ul>
<ul style="list-style-type: none"> <li>Power is suddenly turned off.</li> </ul>	<ul style="list-style-type: none"> <li>The TV's internal temperature has increased. Remove any objects blocking the vent or clean.</li> <li>Is the "Sleep timer" set? Select "Off" from the "Sleep timer" menu (Page 34).</li> <li>Is "No signal off" or "No operation off" activated? (Page 34)</li> </ul>
<ul style="list-style-type: none"> <li>No picture.</li> </ul>	<ul style="list-style-type: none"> <li>Are connections to external equipment correct? (Pages 23–28)</li> <li>Is the input signal type selected correctly after connection? (Page 41)</li> <li>Is the correct input source selected? (Page 18)</li> <li>Is a non-compatible signal being input? (Page 54)</li> <li>Is the picture adjustment correct? (Pages 31–32)</li> <li>Is the antenna connected properly? (Page 9)</li> </ul>
<ul style="list-style-type: none"> <li>No sound.</li> </ul>	<ul style="list-style-type: none"> <li>Is the volume too low?</li> <li>If you do not clearly hear the sound for the visually impaired, go to "HOME" &gt; "TV Menu" &gt; "Setup" &gt; "Audio" &gt; "Audio description setting" &gt; "Mix level", and select the upper level to turn up the volume.</li> <li>Make sure that headphones are not connected.</li> <li>Check if you pressed  on the remote control unit.</li> <li>Is the proper item selected in the "Audio select" menu when connecting devices to the HDMI 2 terminal or the PC terminal? (Pages 24, 26 and 41)</li> </ul>

<ul style="list-style-type: none"> <li>The TV sometimes makes a cracking sound.</li> </ul>	<ul style="list-style-type: none"> <li>This is not a malfunction. This happens when the cabinet slightly expands and contracts according to changes in temperature. This does not affect the TV's performance.</li> </ul>
<ul style="list-style-type: none"> <li>Net TV start page cannot be displayed.</li> </ul>	<ul style="list-style-type: none"> <li>Is the ETHERNET cable connected correctly? (Page 57)</li> <li>Check the settings of "Network setup" (Pages 57–58).</li> </ul>
<ul style="list-style-type: none"> <li>Some Internet functions used on a PC are not available from the TV.</li> </ul>	<ul style="list-style-type: none"> <li>The TV has only limited functions compared with regular PC browsers (Page 59).</li> </ul>

### Reset the PIN





- Go to "HOME" > "TV Menu" > "Setup".
- Press  /  to select "Auto installation", "Programme setup", "PIN", "Parental rating" or "Reset", and then press **OK**. The PIN input window will display.
- Press and hold both **P**  and  + on the TV simultaneously until the message appears on the screen.

### NOTE

- When the PIN code is reset, the default PIN code ("1234") is set.
- The PIN is also available for the Net TV function.

### Reset

If complex adjustments are made so that the settings cannot be restored to normal, you can reset the settings to the factory preset values.

- Go to "HOME" > "TV Menu" > "Setup" > "View setting" > "Reset".
- Press  /  to select "Yes", and then press **OK**.
  - "Now, TV will restart automatically, OK?" displays on the screen.
- Press  /  to select "Yes", and then press **OK**.
  - "Now initialising..." displays on the screen and blinks.
  - After the reset has completed, the power shuts off and then comes back on. The screen will have returned to its original settings.

### NOTE

- PIN input is required when executing "Reset". The default PIN is "1234". To change the PIN setting, refer to **Individual setting — PIN** (Page 38). To reset the PIN setting (PIN input will no longer be needed), refer to **Reset the PIN** shown above.
- "Reset" is greyed out in 3D mode. To select the "Reset" menu, you need to switch to 2D mode.

## Updating your TV via DVB-T/T2\*1/ C/S\*2/S2\*2

Ensure that your TV software version is always up to date. From time to time SHARP will make updated TV base software and DVB software available.

\*1 741 series only

\*2 740 series only

### View setting Download setup

Go to “HOME” > “TV Menu” > “Setup” > “View setting” > “Individual setting” > “Standby search” > “Download setup”.

### Searching for updates\*

\* All countries except UK, Sweden, Finland and Italy are set to “No” for this function.

The TV automatically determines whether a new software version is available when the TV is in standby mode.

Item	
Yes	Automatically searches for new software updates available when the TV is in standby mode.
No	Does not search for update information.
Now	Checks if there is new software immediately.

## Downloading the software

You can select the method of update.

- 1 If the software is updated, the confirmation message “New download information has been detected.” appears.\*
  - If the TV receives the update service while in standby mode, a confirmation message displays after turning on the power.
  - \* When the download is available only at a later time, a confirmation message regarding the scheduled date and time to start downloading from a TV station will be displayed. Download information may be displayed together with the confirmation message.

- 2 Follow the screen prompts.

Item	
Yes	Starts downloading immediately.* It takes approximately one hour to update. You cannot carry out other operations while downloading. <ul style="list-style-type: none"> <li>• Cancels the download by pressing <b>OK</b> on the remote control unit when “Discontinue” is displayed on the screen during the update.</li> </ul>
No	Does not perform downloading.

\* The download will start at the date and time for the scheduled download. Turn on the power of the TV before the scheduled time for downloading or keep it in standby mode.

### NOTE

- Updating the software may take some time.

## Getting update information

### Information Message list

When new software is detected, you can confirm the update information and download the software from “Message list”.

Go to “HOME” > “TV Menu” > “Setup” > “Information” > “Message list”.

### NOTE

- When the TV succeeds at downloading new software, the message is updated in the “Message list” of the “Information” menu.
- The software update will not be carried out if there is no new software available at the specified download time.

### Information Receiver report

Display reports regarding failures and changes for timer settings.

Go to “HOME” > “TV Menu” > “Setup” > “Information” > “Receiver report”.

### Information Identification

You can check the TV ID on the screen for reporting to customer service.

Go to “HOME” > “TV Menu” > “Setup” > “Information” > “Identification”.

### Information on the software licence for this product

#### Information Software licence

You can read the software licences in this menu.

Go to “HOME” > “TV Menu” > “Setup” > “Information” > “Software licence”.

#### ● Software composition

The software included in this product is comprised of various software components whose individual copyrights are held by SHARP or by third parties.

### Updating your TV via USB/network

#### Information Software update

This function allows you to update to the latest software via a USB device or network.

• To check the availability of the latest software versions, visit <http://www.sharp.eu/software-download/> for links to the download pages for the appropriate countries.

- 1 Go to “HOME” > “TV Menu” > “Setup” > “Information” > “Software update” > “USB update”.
  - You can also update the software through the network. Go to “HOME” > “TV Menu” > “Setup” > “Information” > “Software update” > “Network update” and follow the on-screen instruction.
  - A broadband connection and Network setup are required to update the software using the internet (Pages 57–58).
- 2 Press **OK** and then insert the USB device containing the software update file.

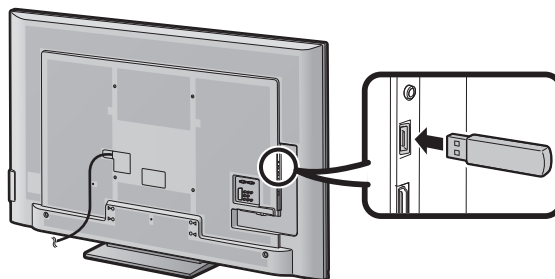

#### CAUTION

- Be sure to insert the USB device correctly into the terminal.
- 3 Press **END** to close the window when a screen prompt pops up.
  - 4 The TV displays a confirmation screen while checking the data in the inserted USB device.

#### CAUTION

- If the data is not compatible with the system, an error message appears on the screen. Repeat steps 2 and 3 after pressing **OK**.
  - When an error message displays, check to see if:
    - The USB device is inserted firmly.
    - The USB memory has two or more software update files.
    - No data for updating the system exists in the USB memory.
    - The software update file is broken.
    - The software update file is not compatible with your TV's software.
    - The current system is same as the system update data.
    - The USB memory is not formatted by FAT32.
- 5 The TV displays the software version information after checking the data.
  - 6 Press **◀/▶** to select “Yes” to update the system, and then press **OK**.
  - 7 The TV restarts automatically, and the software update will be complete.
    - This operation may take a while.

#### CAUTION

- The Net TV memory, which includes the lock code, passwords, and cookies, may be cleared when the software update is carried out.

### Warning regarding basic use

#### Cautions regarding use in high and low temperature environments

- When the TV is used in a low temperature space (e.g., room, office), the picture may leave trails or appear slightly delayed. This is not a malfunction, and the TV will recover when the temperature returns to normal.
- Do not leave the TV in a hot or cold location. Also, do not leave the TV in a location exposed to direct sunlight or near a heater, as this may cause the cabinet to deform and the LCD panel to malfunction.  
Storage temperature: – 20 °C to + 60 °C.

Devices connected to the protective earthing of the building installation through the MAINS connection or through other devices with a connection to protective earthing and to a television distribution system using coaxial cable, may in some circumstances create a fire hazard. Connection to a television distribution system therefore has to be provided through a device providing electrical isolation within a certain frequency range (galvanic isolator, see EN 60728-11).

#### NOTE

- For requirements in Norway and Sweden, the requirements for isolation are also relevant for devices that can be connected to television distribution systems.

### Trademarks

- “HDMI, the HDMI logo and High-Definition Multimedia Interface are trademarks or registered trademarks of HDMI Licensing LLC in the United States and other countries.”
- Manufactured under license from Dolby Laboratories.
- “Dolby” and the double-D symbol are trademarks of Dolby Laboratories.
- The “HD TV 1080p” Logo is a trademark of DIGITALEUROPE.
- The DVB logo is the registered trademark of the Digital Video Broadcasting—DVB—project.
- LCフォント、LCFONT、エルシーフォント and LC logo mark are registered trademarks of SHARP Corporation. This product is embedded with LC Font technology, which was developed by SHARP Corporation for clearly displaying easy-to-read characters on an LCD screen. However, other non-LCD fonts are used for displaying some screen pages.
- DivX®, DivX Certified®, DivX Plus® HD and associated logos are trademarks of Rovi Corporation or its subsidiaries and are used under license.
- ABOUT DIVX VIDEO: DivX® is a digital video format created by DivX, LLC, a subsidiary of Rovi Corporation. This is an official DivX Certified® device that plays DivX video. Visit [divx.com](http://divx.com) for more information and software tools to convert your files into DivX videos.
- ABOUT DIVX VIDEO-ON-DEMAND: This DivX Certified® device must be registered in order to play purchased DivX Video-on-Demand (VOD) movies. To obtain your registration code, locate the DivX VOD section in your device setup menu. Go to [vod.divx.com](http://vod.divx.com) for more information on how to complete your registration.
- YouTube and the YouTube logo are trademarks of Google Inc.
- The Wi-Fi CERTIFIED Logo is a certification mark of the Wi-Fi Alliance.
- The Wi-Fi Protected Setup Mark is a mark of the Wi-Fi Alliance.
- DLNA®, the DLNA Logo and DLNA CERTIFIED™ are trademarks, service marks, or certification marks of the Digital Living Network Alliance.
- All other company or product names are trademarks or registered trademarks of their respective companies.



### Software licences for Net TV

This product includes the Opera™ browser.



- This product contains fonts provided by Monotype Imaging Inc.
- Monotype® is a trademark of Monotype Imaging Inc. registered in the United States Patent and Trademark Office and may be registered in certain jurisdictions.
- Tioga™ is a trademark of Monotype Imaging Inc. and may be registered in certain jurisdictions.
- Letter Gothic™ is a trademark of The Monotype Corp. and may be registered in certain jurisdictions.
- iType® is a trademark of Monotype Imaging Inc. registered in the United States Patent and Trademark Office and may be registered in certain jurisdictions.
- This product contains the iType® font engine from Monotype Imaging Inc.

### Disclaimers for services using the Internet

#### DISCLAIMERS

- This SHARP device facilitates the access to content and services provided by third parties. The content and services accessible via this device belong to and may be proprietary to third parties. Therefore, any use of such third party content and services must be in accordance with any authorization or terms of use provided by such content or service provider. SHARP shall not be liable to you or any third party for your failure to abide by such authorization or terms of use. Unless otherwise specifically authorized by the applicable content or service provider, all third party content and services provided are for personal and non-commercial use; you may not modify, copy, distribute, transmit, display, perform, reproduce, upload, publish, license, create derivative works from, transfer or sell in any manner or medium any content or services available via this device.
- SHARP is not responsible, nor liable, for customer service-related issues related to the third party content or services. Any questions, comments or service-related inquiries relating to the third party content or service should be made directly to the applicable content or service provider.
- You may not be able to access content or services from the device for a variety of reasons which may be unrelated to the device itself, including, but not limited to, power failure, other Internet connection, or failure to configure your device properly. SHARP, its directors, officers, employees, agents, contractors and affiliates shall not be liable to you or any third party with respect to such failures or maintenance outages, regardless of cause or whether or not it could have been avoided.
- ALL THIRD PARTY CONTENT OR SERVICES ACCESSIBLE VIA THIS DEVICE IS PROVIDED TO YOU ON AN "AS-IS" AND "AS AVAILABLE" BASIS AND SHARP AND ITS AFFILIATES MAKE NO WARRANTY OR REPRESENTATION OF ANY KIND TO YOU, EITHER EXPRESS OR IMPLIED, INCLUDING, WITHOUT LIMITATION, ANY WARRANTIES OF MERCHANTABILITY, NON-INFRINGEMENT, FITNESS FOR A PARTICULAR PURPOSE OR ANY WARRANTIES OF SUITABILITY, AVAILABILITY, ACCURACY, COMPLETENESS, SECURITY, TITLE, USEFULNESS, LACK OF NEGLIGENCE OR ERROR-FREE OR UNINTERRUPTED OPERATION OR USE OF THE CONTENT OR SERVICES PROVIDED TO YOU OR THAT THE CONTENT OR SERVICES WILL MEET YOUR REQUIREMENTS OR EXPECTATIONS.
- SHARP IS NOT AN AGENT OF AND ASSUMES NO RESPONSIBILITY FOR THE ACTS OR OMISSIONS OF THIRD PARTY CONTENT OR SERVICE PROVIDERS, NOR ANY ASPECT OF THE CONTENT OR SERVICE RELATED TO SUCH THIRD PARTY PROVIDERS.
- IN NO EVENT WILL SHARP AND/OR ITS AFFILIATES BE LIABLE TO YOU OR ANY THIRD PARTY FOR ANY DIRECT, INDIRECT, SPECIAL, INCIDENTAL, PUNITIVE, CONSEQUENTIAL OR OTHER DAMAGES, WHETHER THE THEORY OF LIABILITY IS BASED ON CONTRACT, TORT, NEGLIGENCE, BREACH OF WARRANTY, STRICT LIABILITY OR OTHERWISE AND WHETHER OR NOT SHARP AND/OR ITS AFFILIATES HAVE BEEN ADVISED OF THE POSSIBILITY OF SUCH DAMAGES.

## Specifications

Item		LCD COLOUR TV (70"/177 cm), LC-70LE740E LC-70LE740RU LC-70LE741E LC-70LE741S	LCD COLOUR TV (60"/152 cm), LC-60LE740E LC-60LE740RU LC-60LE741E LC-60LE741S
LCD panel		177 cm (70") X-Gen panel	152 cm (60") X-Gen panel
Resolution		1,920 x 1,080 x 3 dots	
Video colour system		PAL/SECAM/NTSC 3.58/NTSC 4.43/PAL 60	
TV function	TV-standard	Analogue	CCIR (B/G, I, D/K, L/L')
		Digital (740 series)	DVB-T (2K/8K OFDM), DVB-C, DVB-S/S2
		Digital (741 series)	DVB-T (2K/8K OFDM), DVB-T2 (1K/2K/4K/8K/16K/32K OFDM), DVB-C
	Receiving channel	VHF/UHF	IR A ch–E69 ch (Digital), E2–E69 ch, F2–F10 ch, I21–I69 ch, IR A–IR J ch
		CATV	Hyper-band, S1–S41 ch
		Satellite (740 series only)	950–2150 MHz*1
TV-tuning system		Auto Preset 999 ch (non-Nordic [DTV]), Auto Preset 9999 ch (Nordic [DTV]), Auto Preset 99 ch (ATV), Auto Label, Auto Sort, Auto Preset 9999 ch (SAT [740 series only])	
Stereo/Bilingual		A2/NICAM	
Audio amplifier		10 W x 2	
Speaker		(150 mm x 32 mm) x 2	
Terminals	Antenna	VHF/UHF	75 Ω Din type (analogue & digital)
		Satellite (740 series only)	75 Ω F type (DVB-S/S2)
	RS-232C	D-sub 9 pin male connector	
	EXT 1	SCART (AV input, Y/C input, RGB input, TV output)	
	EXT 2	RCA pin (AV input/AUDIO L/R)	
	EXT 3	Component (AV input/Audio L/R)	
	PC	mini D-sub 15 pin	

	HDMI 1 (EXT 4)	HDMI (ARC)
	HDMI 2 (EXT 5)	HDMI
	HDMI 3 (EXT 6)	HDMI
	HDMI 4 (EXT 7)	HDMI
	USB 1	USB (DC 5 V, 500 mA)
	USB 2 (HDD)	USB (DC 5 V, 1000 mA)
	USB 3 (WIRELESS LAN)	USB (DC 5 V, 500 mA)
	ETHERNET (10/100)	Network connector
	HDMI 2/PC AUDIO (L/R)	Ø 3.5 mm jack*2
	DIGITAL AUDIO OUTPUT	Optical S/PDIF digital audio output
	C. I. (Common Interface)	EN50221, R206001, CI Plus specification
	OUTPUT/Headphones	RCA pin (AUDIO L/R)/Ø 3.5 mm jack (audio output)
	SD CARD (VIDEO STORE)	SD card
OSD language		Arabic, Chinese, Czech, Danish, Dutch, English, Estonian, Finnish, French, German, Greek, Hungarian, Italian, Latvian, Lithuanian, Norwegian, Polish, Portuguese, Romanian, Russian, Slovak, Slovene, Spanish, Swedish, Turkish, Ukrainian
Power requirement		AC 220–240 V, 50 Hz
Power consumption		222 W (0.1 W standby*3) 178 W (0.1 W standby*3)
Weight		37.5 kg (without stand) 40.5 kg (with stand) 26.5 kg (without stand) 29.5 kg (with stand)
Operating temperature		0 °C to + 40 °C

\*1 The satellite channel's frequency may vary according to satellites and antennas.

\*2 The HDMI 2 and PC terminals can both use the same audio input terminal.

\*3 Standby power consumption applies when the TV is set to not receive EPG data.

- As a part of our policy of continuous improvement, SHARP reserves the right to make design and specification changes for product improvement without prior notice. The performance specification figures indicated are nominal values of production units. There may be some deviations from these values in individual units.

## Specifications (Wireless LAN USB adapter)

Product name		Dual Band 802.11n USB2.0 adapter	
Standard		IEEE 802.11a/b/g/n	
Host interface		USB2.0	
Frequency band		2412–2484 MHz 5150–5850 MHz	
Security		Static WEP (64/128 bit, key index 1 only) WPA-PSK (TKIP) WPA2-PSK (AES)	
Modulation		DBPSK@1 Mbps DQPSK@2 Mbps CCK@5.5/11 Mbps BPSK@6/9 Mbps QPSK@12/18 Mbps 16-QAM@24 Mbps 64-QAM@48/54 Mbps and above, Rx up to 300 Mbps	
Transmit power and sensitivity	Tx output power: (Typical)	2.4 GHz	11b 17 +/- 1.5 dBm 11g 14 +/- 1.5 dBm 11n 13 +/- 1.5 dBm
		5 GHz (5150–5250 MHz, 5250–5350 MHz)	11a 14 +/- 1.5 dBm 11n 13 +/- 1.5 dBm
		5 GHz (5470–5725 MHz, 5725–5850 MHz)	11a 13 +/- 1.5 dBm 11n 13 +/- 1.5 dBm
	Rx sensitivity: (Typical)		-84 dBm@11 Mbps -72 dBm@54 Mbps -64 dBm@64-QAM, 20 MHz channel spacing -61 dBm@64-QAM, 40 MHz channel spacing
Current Consumption (DC 5V)		Tx: 2.2 W (Typical) Rx: 1.4 W (Typical)	
Weight		13 g	
Dimensions		20.0 (W) × 73.3 (D) × 8.0 (H) mm	
Operating temperature		0 °C to + 40 °C	

### NOTE

- This TV has received the following certifications when connected in an environment using the supplied SHARP wireless LAN adapter.
  - Wi-Fi CERTIFIED™ (certification program from the Wi-Fi Alliance®)
  - Wi-Fi Protected Setup™ (certification program from the Wi-Fi Alliance®)
- When there is significant interference in the 2.4-GHz frequency (such as from other wireless LAN devices, Bluetooth® devices, 2.4-GHz cordless telephones, and microwave ovens), it is recommended that you use a wireless LAN access point that supports IEEE802.11a/n (5 GHz) and set the access point to transmit at 5 GHz. For setup details, see the operation manual of your access point.
- Before transferring to a third party or disposal, be sure to initialize the wireless LAN settings.
- Wireless LAN USB adapter (WN8522D 7-JU) is Peripheral Device for TV and supports WEP64, WEP128, TKIP and AES encryptions.
- Using a wireless LAN adapter other than the supplied SHARP wireless LAN adapter may result in radio communications that do not comply with regulations on radio communications. Therefore, do not use a wireless LAN adapter other than the supplied SHARP wireless LAN adapter.

### Environmental specifications

Item		70 inch models	60 inch models
*1	On-mode (W) (in home-mode)	135 W	100 W
*2	Energy-Save-Mode (W) Advanced	96 W	75 W
*3	Standby-Mode (W)	0.1 W	0.1 W
*4	Annual Energy Consumption (kWh)	197 kWh	146 kWh
*4	Annual Energy Consumption Energy-Save-Mode (kWh) Advanced	140 kWh	110 kWh

\*1 Measured according to IEC 62087 Ed. 2

\*2 For further information about the Energy Save function, please see related pages in this operation manual

\*3 Measured according to EN 62301 Ed. 1

Standby power consumption applies when the TV is set to not receive EPG data

\*4 Annual energy consumption is calculated according to EU Regulation (EU) No 1062/2010 based on operating 4 hours per day for 365 days a year

#### NOTE

- The power consumption of on-mode varies depending on the images the TV displays.

### Mounting the TV on a wall

- This TV should be mounted on a wall only with a SHARP wall mount bracket (Page 4). The use of other wall mount brackets may result in an unstable installation and may cause serious injuries.
- Mounting the LCD colour TV requires special skills and should only be performed by qualified service personnel. Customers should not attempt to do the work themselves. SHARP bears no responsibility for improper mounting or mounting that results in accident or injury.
- You can ask qualified service personnel about using an optional bracket to mount the TV to a wall.
- When you mount the TV on a wall, you should attach the supporting post.

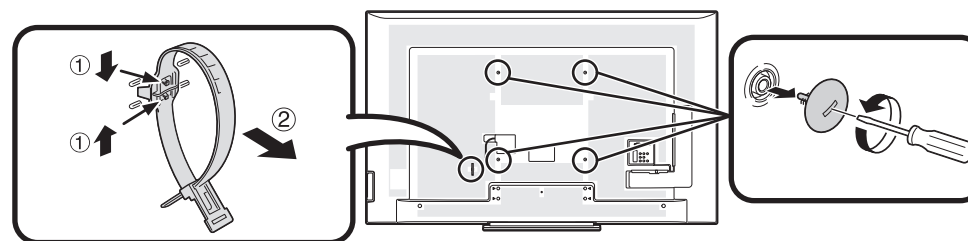

#### NOTE

- Detach the cable tie on the rear of the TV when using the optional mount bracket.
- Due to the terminal configuration on this TV, when you wall-mount this model, make sure there is enough space between the wall and the TV for the cables.
- To use this TV mounted on a wall, remove the AC cord holder and the covers at the 4 locations on the rear of the TV, and then use the screws supplied with the wall mount bracket to secure the bracket to the rear of the TV.

#### ● Wall mount audio setup

When you mount the TV on a wall, you can adjust the sound to a more suitable one by setting this function to “Yes”.

Go to “HOME” > “TV Menu” > “Setup” > “View setting” > “Wall mount audio setup”.

## Appendix

### Rating table for child lock

User-adjusted rating	Broadcasted rating																	
	AGE																	
	4	5	6	7	8	9	10	11	12	13	14	15	16	17	18			
Universal viewing	✓	–	–	–	–	–	–	–	–	–	–	–	–	–	–	–	–	
Parental approval pref.	✓	✓	✓	✓	✓	–	–	–	–	–	–	–	–	–	–	–		
X-rated	✓	✓	✓	✓	✓	✓	✓	✓	✓	✓	✓	✓	✓	✓	✓	✓		

User-adjusted rating	Broadcasted rating		
	Universal viewing	Parental approval pref.	X-rated
Universal viewing	–	–	–
Parental approval pref.	✓	–	–
X-rated	✓	✓	–

### Abbreviation list

Abbreviated term	Stands for
ARC	Audio Return Channel
ATV	Analogue TV
CEC	Consumer Electronics Control
DivX®	Digital Video Xtreme®
DNR	Digital Noise Reduction
DTV	Digital TV
DVB-C	Digital Video Broadcasting-Cable
DVB-S	Digital Video Broadcasting-Satellite
DVB-S2	Digital Video Broadcasting-Satellite-Second Generation
DVB-T	Digital Video Broadcasting-Terrestrial
DVB-T2	Digital Video Broadcasting-Terrestrial Version 2
DVI	Digital Visual Interface
EPG	Electronic Programme Guide
HDCP	High-bandwidth Digital Content Protection
HDMI	High-Definition Multimedia Interface
LAN	Local Area Network
MHEG	Multimedia and Hypermedia Expert Group
OSD	On Screen Display
PCM	Pulse Code Modulation
SAT	Satellite
USB	Universal Serial Bus
WPS	Wi-Fi® Protected Setup
WSS	Wide Screen Signalling

Dimensional drawings

LC-70LE740E  
 LC-70LE740RU  
 LC-70LE741E  
 LC-70LE741S

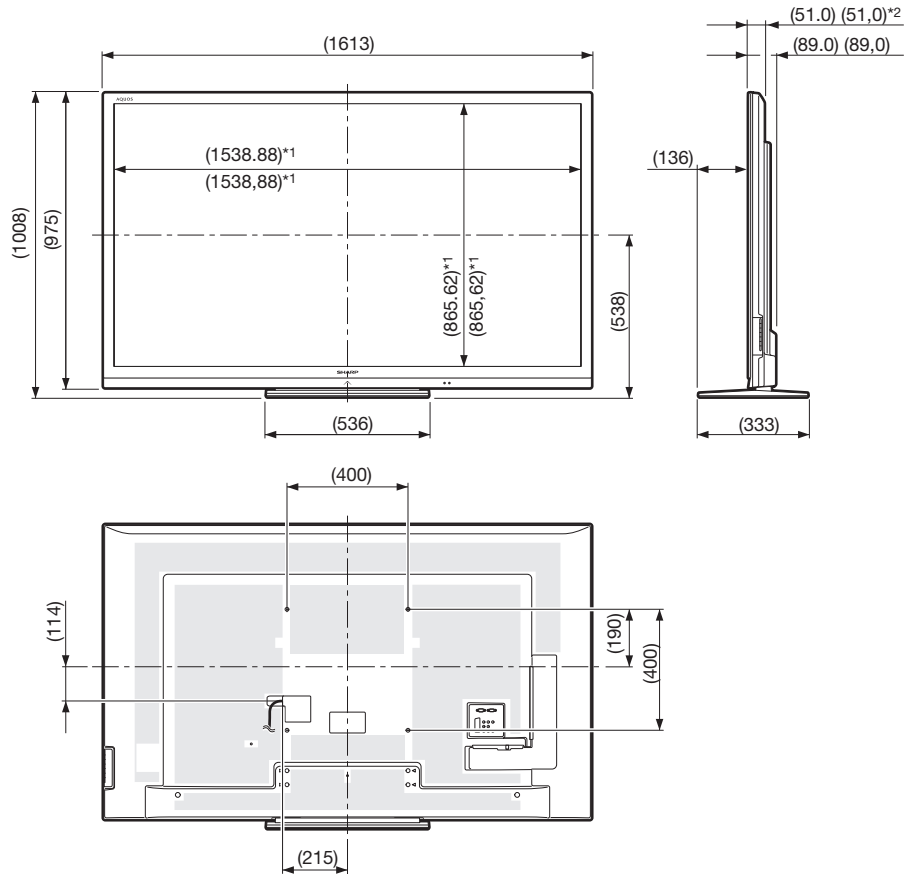

LC-60LE740E  
 LC-60LE740RU  
 LC-60LE741E  
 LC-60LE741S

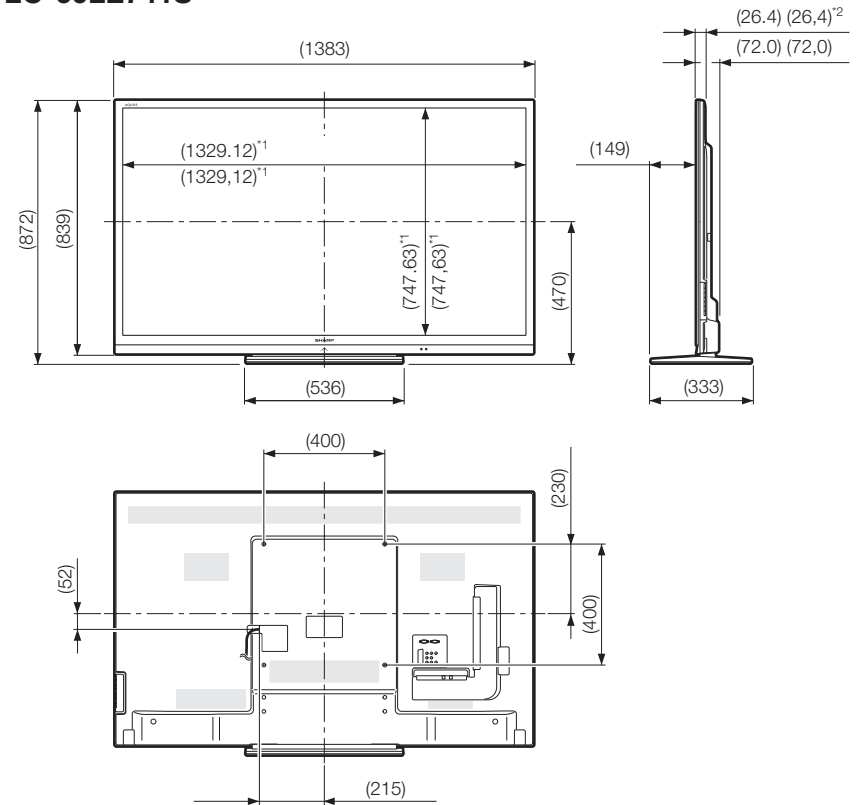

\*1 Active area  
 \*2 Thinnest part (except of terminal height)

**NOTE**

- Dimensions do not include protrusions such as screws and some parts.

### EU Energy Label for Televisions

On 30 November, 2010 the European Commission adopted the Commission Delegated Regulation (EU) No 1062/2010 with regard to energy labelling of televisions.

The Regulation entered into force on 20 December 2010 and applies in all Member States.

Manufacturers and dealers are required to display the label shown below, on their televisions from 30 November 2011.

The label provides information to assist consumers in evaluating televisions for energy efficiency and energy consumption and to make a purchasing decision that contributes to the protection of the environment and to a lower carbon society.

The figure below shows the label design and explains the information included. For further information please visit the Sharp internet homepage (<http://www.sharp.eu>).

The retailer or online shop where you purchased your television from would have displayed the label and its corresponding rating. If in doubt please consult them.

In addition to saving energy many Sharp LCD televisions also carry the EU Ecolabel, a voluntary environmental label that is awarded to goods which meet the environmental requirements of the EU ecolabelling scheme (for details see <http://ec.europa.eu/environment/ecolabel/>). This voluntary label enhances further the environmental credentials of our televisions.

### EU Energy Label TV

1	EU framework directive on the energy label: It has applied to household appliances since 1992 and was expanded to cover 'energy-consumption-related products' in June of 2010. The sub-ordinance was promulgated on 30 November 2010; usage is voluntary as of 20 December 2010 and compulsory as of 30 November 2011.
2	The label language is neutral
3	Brand and product name
4	Energy efficiency class Energy efficiency class (7 classes/7 colours: A to G [subsequently A+ to F, A++ to E, A+++ to D]; measurement values are the visible surface of the panel and ON mode consumption)
5	ON/OFF switch (yes/no)
6	Power consumption (watts)
7	Annual energy consumption in kWh based on 4 hours' operation per day, 365 days per year
8	Screen diagonal (cm/inch)
9	Regulation designation and year of commencement of the compulsory use of the label.
10	EU Ecolabel (optional use if the product has been awarded the EU environmental label)
11	EU Ecolabel registration number

The illustration is not to scale. According to EU Regulation 1062/2010, the EU energy label TV appliances amounts to at least 6 x 12 centimetres.

SHARP

Infographics 2010

#### NOTE

- Methods for calculating the Energy Efficiency Index and the annual on-mode energy consumption are set out in Annex II of Regulation (EU) No 1062/2010. The determination of the on-mode consumption is based on the international standard IEC 62087 Ed. 2

**SHARP**<sup>®</sup>

SHARP ELECTRONICS (Europe) GmbH

Sonninstraße 3, D-20097 Hamburg

SHARP CORPORATION

<http://www.sharp-eu.com>