

Connecting transmitter to the audio source | Sender an Tonquelle anschließen | Raccorder l'émetteur à la source sonore

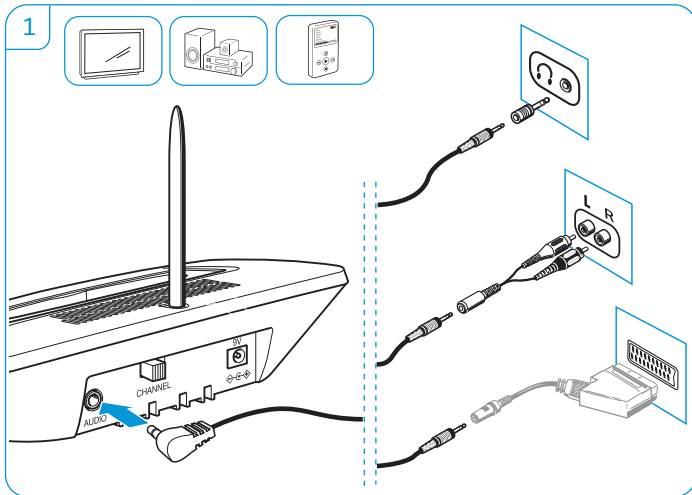

Connecting transmitter to the mains | Sender ans Stromnetz anschließen | Raccorder l'émetteur au secteur

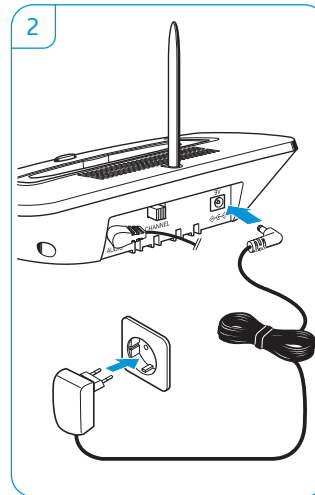

Charging the receiver battery | Hörer-Akkus laden | Charger l'accu du récepteur

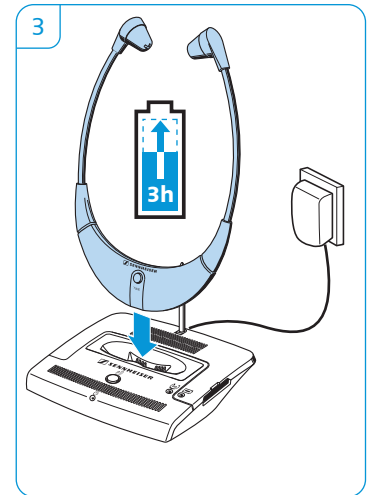

Automatically switching the receiver on/off and wearing it | Hörer automatisch ein-/ausschalten und tragen | éteindre automatiquement le récepteur et le placer sur vos oreilles

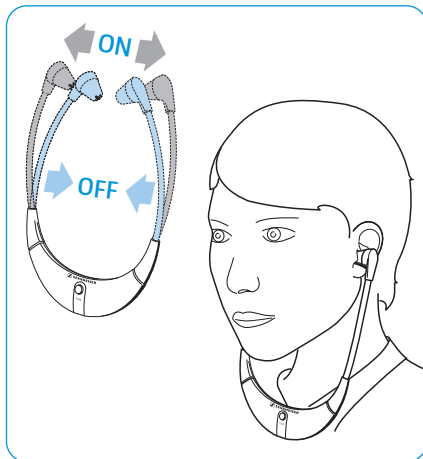

Adjusting the volume | Lautstärke einstellen | Régler le volume

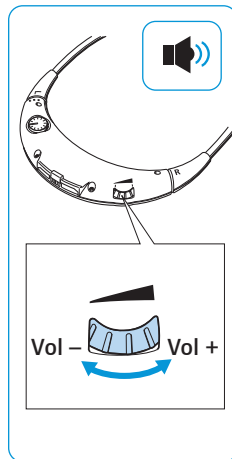

Adjusting the balance | Balance einstellen | Régler la balance

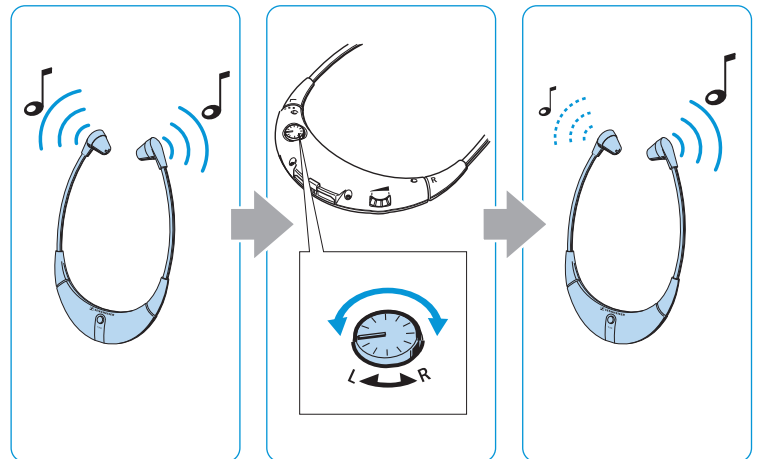

Enhancing speech intelligibility | Sprachverständlichkeit verbessern | Améliorer l'intelligibilité de la parole

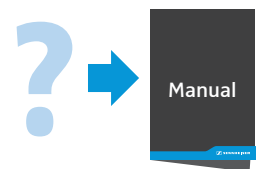
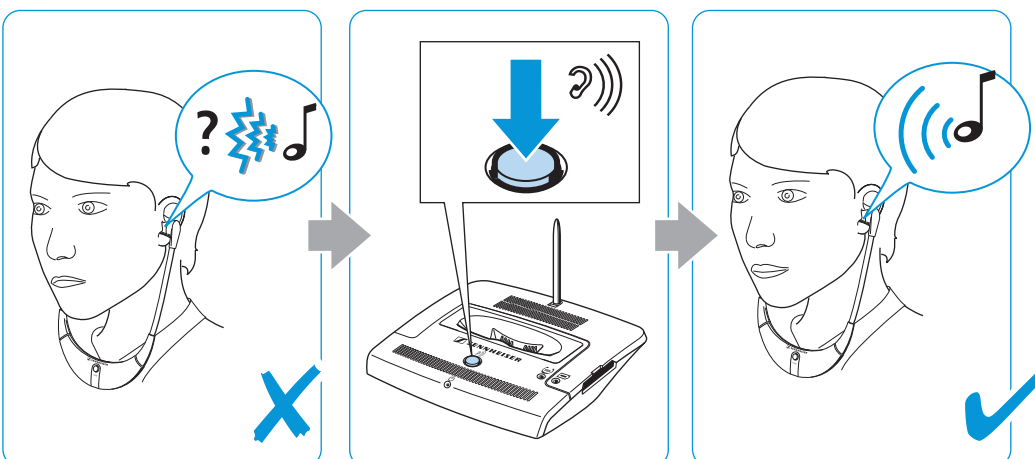

Conectar el transmisor a una fuente de audio | Collegamento del trasmettitore alla sorgente audio | De zender op de geluidsbron aansluiten | Ligar o emissor à fonte áudio

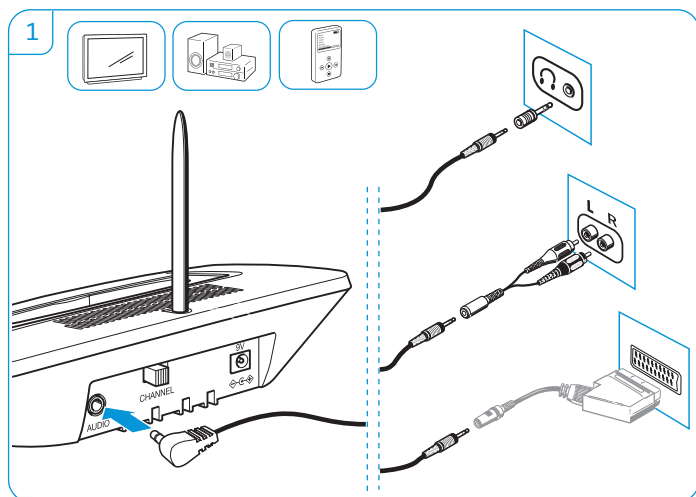

Conectar el transmisor a la red eléctrica | Collegamento del trasmettitore alla rete elettrica | De zender op de voedingspanning aansluiten | Ligar o emissor à rede eléctrica

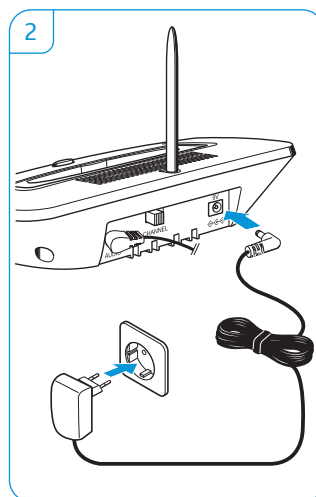

Cargar las pilas recargables del auricular | Caricamento della batteria delle cuffie | Hoofdtelefoonaccu's opladen | Carregar as pilhas recarregáveis dos auscultadores

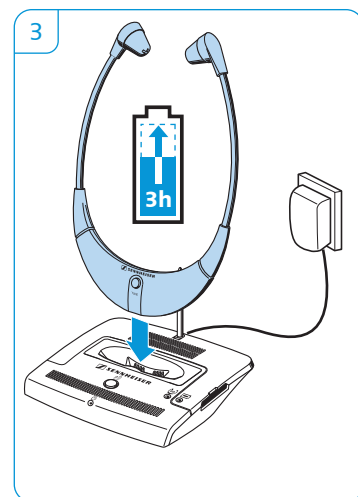

Conectar/Desconectar automáticamente y llevar el auricular | Accensione/spengimento automatico e trasporto delle cuffie | De hoofdtelefoon automatisch in-/uitschakelen en dragen | Ligar/desligar e utilizar os auscultadores

Ajustar el volumen | Impostazione del volume | Volume instellen | Ajustar o volume

Ajustar el balance | Impostazione del bilanciamento | Balans instellen | Definir «Balance»

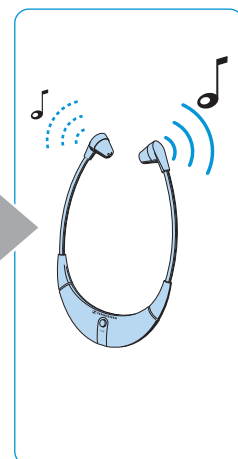
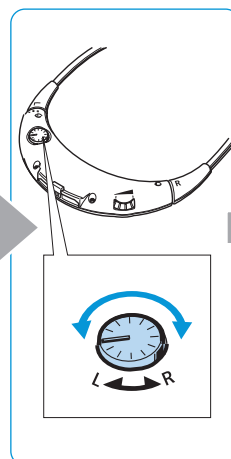
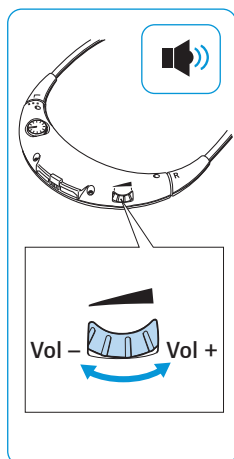
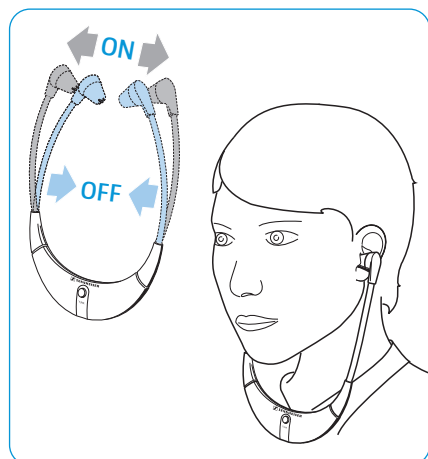

Mejorar la inteligibilidad de la voz | Miglioramento della chiarezza vocale | Spraakverstaanbaarheid verbeteren | Melhorar a inteligibilidade da fala

