

SHIMANO STEPS

SHIMANO Total Electric Power System

User's manual

E5000 Series

Original instructions

CONTENTS

| | |
|---|-----------|
| IMPORTANT NOTICE | 3 |
| Important safety information | 3 |
| To ensure safety | 3 |
| NOTICE | 4 |
| Booklet Structure | 7 |
| Features of SHIMANO STEPS | 8 |
| Assist mode | 8 |
| Start your SHIMANO STEPS | 9 |
| Names of parts | 12 |
| Specifications | 13 |
| Preparation | 14 |
| Charging the battery | 14 |
| Charger LED lamp | 18 |
| Battery LED lamp | 18 |
| Handling the battery | 19 |
| Installing and removing the battery..... | 20 |
| Installing and removing the cycle computer (SC-E6100) | 25 |
| Operation | 26 |
| Turning the power ON / OFF | 26 |
| Basic operation | 28 |
| Turning the light ON / OFF | 30 |
| Basic status display..... | 31 |
| Changing the assist mode | 33 |
| Walk assist mode | 35 |
| Switching the travel data display (SC-E6100)..... | 37 |
| Switching the travel data display (SC-E7000)..... | 39 |
| Switch the gear shifting mode..... | 40 |

| | |
|--|-----------|
| Setting menu | 41 |
| Launching (SC-E6100) | 41 |
| Launching (SC-E7000) | 43 |
| [Clear] Setting reset | 45 |
| [Clock] Time setting | 47 |
| [Start mode] Start mode setting | 49 |
| [Backlight] Backlight setting (SC-E6100 only) | 50 |
| [Brightness] Backlight brightness setting (SC-E6100 only) | 51 |
| [Light] Light ON/OFF (SC-E7000 only) | 52 |
| [Beep] Beep setting | 53 |
| [Unit] Km/mile switching | 54 |
| [Language] Language setting | 55 |
| [Font color] Font color settings | 56 |
| [Adjust] Gear shifting adjustment with the electronic gear shifting unit | 56 |
| [Shift timing] Automatic gear shifting timing setting | 57 |
| [Shifting advice] Shifting advice setting (SC-E6100 only) | 58 |
| [RD protection reset] RD protection reset | 59 |
| [Display speed] Adjusting the display speed | 60 |
| [Exit] Close setting menu screen | 60 |
| | |
| Settings (EW-EN100) | 61 |
| RD protection reset | 61 |
| Adjust | 61 |
| | |
| Connection and communication with devices | 62 |
| About wireless functions | 62 |
| | |
| Errors and remedies | 63 |
| Battery LED lamp error indications | 63 |
| Error messages on the cycle computer | 64 |
| Error indications (EW-EN100) | 67 |
| Troubleshooting | 68 |

IMPORTANT NOTICE

- Contact the place of purchase or a distributor for information on installation, adjustment, and replacement of the products which are not found in the user's manual. A dealer's manual for professional and experienced bicycle mechanics is available on our website (<https://si.shimano.com>).
- Use the product according to local laws and regulations.
- The Bluetooth® word mark and logos are registered trademarks owned by Bluetooth SIG, Inc. and any use of such marks by SHIMANO INC. is under license. Other trademarks and trade names are those of their respective owners.

For safety, be sure to read this "user's manual" thoroughly before use, follow it for correct use, and store it so that it can be referenced at any time.

Important safety information

WARNING

- Do not disassemble or modify the product. This may cause the product to not operate correctly, and you may suddenly fall and be seriously injured.

To ensure safety

- Be sure to observe the following in order to avoid burns or other injury from fluid leakages, overheating, fire or explosions.

DANGER

Handling the battery

- Do not deform, modify, disassemble or apply solder directly to the battery. Doing so may cause leakage, overheating, bursting, or ignition of the battery.
- Do not leave the battery near sources of heat such as heaters. Doing so may cause bursting or ignition of the battery.
- Do not heat the battery or throw it into a fire. Doing so may cause bursting or ignition of the battery.
- Do not subject the battery to strong shocks or throw it. If this is not observed, overheating, bursting, or fire may occur.

- Do not place the battery into fresh water or sea water, and do not allow the battery terminals to get wet. Doing so may cause overheating, bursting, or ignition of the battery.
- Use the SHIMANO specified charger and observe the specified charging conditions when charging the specified battery. Not doing so may cause overheating, bursting, or ignition of the battery.

WARNING

To ensure safe riding

- Do not give too much of your attention to the cycle computer display while riding, otherwise accidents may result.
- Check that the wheels are securely installed to the bicycle before commencing riding. If the wheels are not securely installed, the bicycle may fall over and cause serious injury.
- If riding a power-assisted bicycle, make sure that you are fully familiar with the starting-off characteristics of the bicycle before riding it on roads with several vehicle lanes and pedestrian footpaths. If the bicycle starts off suddenly, accidents may result.
- Check that the bicycle lights illuminate before riding at night.

Using the product safely

- Be sure to remove the battery and charging cable before wiring or attaching parts to the bicycle. Otherwise, an electric shock may result.
- When charging the battery while it is installed on the bicycle, do not move the bicycle. The power plug for the battery charger may come loose and not be fully inserted into the electrical outlet, resulting in risk of fire.
- Do not touch the drive unit when it has been continuously used for a long period of time. The surface of the drive unit becomes hot and could cause burns.
- Periodically clean the chain using an appropriate chain cleaner. The frequency of maintenance will vary depending on the riding conditions.
- Do not use alkaline or acidic cleaning agents for removing rust under any circumstances. If such cleaning agents are used, they may damage the chain and serious injury may result.
- When installing this product, be sure to follow the instructions given in the user's manual. Furthermore, it is recommended that you use only genuine SHIMANO parts at these times. If bolts and nuts are left loosened or the product is damaged, the bicycle may suddenly fall over and serious injury may result.

Handling the battery

- If any liquid leaking from the battery gets into your eyes, immediately wash the affected area thoroughly with clean water such as tap water without rubbing your eyes, and seek medical advice immediately. If this is not done, the battery liquid may damage your eyes.
- Do not recharge the battery in places with high humidity or outdoors. Doing so may result in electric shock.
- Do not insert or remove the plug while it is wet. If this is not observed, electric shocks may result. If there is water leaking out of the plug, dry it thoroughly before inserting it. Refer to the battery charger user's manual for the designated charging time of the battery.
- If the battery does not become fully charged even 2 hours after the designated charging time, immediately unplug the battery from the outlet and contact the place of purchase. Doing otherwise may cause overheating, bursting, or ignition of the battery.
- Do not use the battery if it has any noticeable scratches or other external damage. Doing so may cause bursting, overheating or problems with operation.
- The operating temperature ranges for the battery are given below. Do not use the battery in temperatures outside these ranges. If the battery is used or stored in temperatures outside these ranges, fire, injury or problems with operation may occur.
 1. During discharge: -10 °C - 50 °C
 2. During charging: 0 °C - 40 °C



To ensure safe riding

- Observe the instructions in the user's manual for the bicycle, in order to ride safely.

Using the product safely

- Never attempt to modify the system yourself. It may cause problems with system operation.
- Periodically check the battery charger and adapter, particularly the cord, plug, and case, for any damage. If the charger or adapter is broken, do not use it until it has been repaired.
- This appliance is not intended for use by persons (including children) with reduced physical, sensory or mental capabilities, or lack of experience and knowledge, unless they have been given supervision or instruction concerning use of the appliance by a person responsible for their safety.
- Do not allow children to play near the product.

Handling the battery

- Do not leave the battery in a place exposed to direct sunlight, inside a vehicle on a hot day, or other hot places. This may result in battery leakage.
- If any leaked fluid gets on your skin or clothes, wash it off immediately with clean water. The leaked fluid may damage your skin.
- Store the battery in a safe place out of the reach of infants and pets.

NOTICE

Using the product safely

- If any malfunctions or other problems occur, contact the place of purchase.
- Be sure to install caps to any connectors which are not being used.
- For installation and adjustment of the product, consult a dealer.
- The Product is designed to be fully waterproof to withstand wet weather riding conditions. However, do not deliberately place them into water.
- Do not clean the bicycle in a high-pressure wash. If water gets into any of the components, operating problems or rusting may result.
- Do not turn the bicycle upside down. The cycle computer or the shifting switch may get damaged.
- Handle the product carefully, and avoid subjecting it to any strong shocks.
- Although the bicycle still functions as a normal bicycle even when the battery is removed, the light does not turn on if it is connected to the electric power system. Be aware that using the bicycle under these conditions will be considered non-observance of the road traffic laws in Germany.
- When charging the battery while it is mounted on the bicycle, be careful of the following:
 - When charging, make sure there is no water on the charging port or the charger plug.
 - Ensure that the battery is locked into the battery mount before charging.
 - Do not remove the battery from the battery mount while charging.
 - Do not ride with the charger mounted.
 - Close the charging port cap when not charging.
 - Stabilize the bicycle to ensure that it does not collapse during charging.

Handling the battery

- When you carry a power-assisted bicycle in a car, remove the battery from the bicycle and place the bicycle on a stable surface in the car.
- Before connecting the battery, make sure that there is no buildup of water or dirt in the connector where the battery will be connected.
- The use of a genuine SHIMANO battery is recommended. If using a battery from another manufacturer, make sure to carefully read the instruction manual for the battery before use.

About used batteries

Disposal information for countries outside the European Union



This symbol is only valid within the European Union. Follow local regulations when disposing of used batteries. If you are not sure, consult the place of purchase or a bicycle dealer.

- Contact the place of purchase for updates of the product software. The most up-to-date information is available on the SHIMANO website. For details, refer to the "Connection and communication with the devices" section.
- Do not use thinner or other solvents to clean any of the products. As such substances may damage the surfaces.
- You should periodically wash the chainrings in a neutral detergent. In addition, cleaning the chain with neutral detergent and lubricating it can be an effective way of extending the useful life of the chainrings and the chain.
- Use a damp cloth, with the water well wrung out, when cleaning the battery and plastic cover.
- For any questions regarding handling and maintenance, contact the place of purchase.
- Products are not guaranteed against natural wear and deterioration from normal use and aging.
- For maximum performance we highly recommend SHIMANO lubricants and maintenance products.

Assist

- If the settings are not correct, for instance if the chain tension is too tight, the proper assist force may not be obtained. If this happens, contact the place of purchase.

Label

- Some of the important information contained in this user's manual is also indicated on the battery charger label.

Inspection prior to each ride

Check the following before riding the bicycle.

- Is the drivetrain shifting smoothly?
- Is there looseness or damage on the component parts?
- Is the component mounted securely to the frame/handlebar/stem?
- Is there abnormal noise during riding?
- Is the battery sufficiently charged?

If you notice any potential problem, please contact the place of purchase or a bicycle dealer.

Please avoid wearing clothes that can get caught in the chain or wheel because it can lead to an accident.

Connection and communication with PCs

A PC linkage device can be used to connect a PC to the bicycle (system or components), and E-TUBE PROJECT can be used to carry out tasks such as customizing single components or the whole system and updating firmware.

- PC linkage device: SM-PCE1/SM-PCE02
- E-TUBE PROJECT: PC application
- Firmware: software inside each component

Connection and communication with smartphones and tablets

It is possible to customize single components or the system, and update firmware, using E-TUBE PROJECT for smartphones/tablets after connecting the bicycle (system or components) to a smartphone or tablet via Bluetooth® LE.

- E-TUBE PROJECT: app for smartphones/tablets
- Firmware: software inside each component

Care and maintenance

- The number found on the battery mount key is necessary when purchasing spare keys. Keep it in a safe place. There is a space to enter the key number on the back cover of this user's manual. Enter the key number for safekeeping and later reference.

FCC compliance information

This device complies with Part 15 of the FCC Rules.

Operation is subject to the following two conditions:

- (1) This device may not cause harmful interference, and
- (2) This device must accept any interference received, including interference that may cause undesired operation.

NOTICE: This equipment has been tested and found to comply with the limits for a Class B digital device, pursuant to Part 15 of the FCC Rules. These limits are designed to provide reasonable protection against harmful interference in a residential installation. This equipment generates, uses and can radiate radio frequency energy and, if not installed and used in accordance with the instructions, may cause harmful interference to radio communications. However, there is no guarantee that interference will not occur in a particular installation. If this equipment does cause harmful interference to radio or television reception, which can be determined by turning the equipment off and on, the user is encouraged to try to correct the interference by one or more of the following measures:

- Reorient or relocate the receiving antenna.
- Increase the separation between the equipment and receiver.
- Connect the equipment into an outlet on a circuit different from that to which the receiver is connected.
- Consult the dealer or an experienced radio/TV technician for help.

Booklet Structure

SHIMANO STEPS user's manuals are split among several booklets, as described below.

- **SHIMANO STEPS user's manual (this document)**

This is the basic user's manual for SHIMANO STEPS. It contains the following content.

- SHIMANO STEPS quick guide
- How to read the cycle computer and configure settings
- How to operate assist bicycles that use flat handlebars, such as city, trekking, or MTB type bicycles
- How to handle errors displayed on the cycle computer and perform other troubleshooting tasks

- **SHIMANO STEPS user's manual for drop handlebar bicycles (separate booklet)**

This booklet describes how to operate assist bicycles that use a drop handlebar and are controlled using a dual control lever. This should be read along with the SHIMANO STEPS user's manual.

- **SHIMANO STEPS special battery and parts user's manual**

It contains the following content.

- How to charge and handle the SHIMANO STEPS special battery
- How to attach and remove the SHIMANO STEPS special battery to the bicycle
- How to use the satellite power button and satellite charging port
- How to read the battery LEDs when charging or during an error, and how to handle errors

Be sure to read these user's manuals thoroughly before use, and follow it for correct use. Store the user's manuals so that they can be referenced at any time.

The latest user's manuals are available on our website (<https://si.shimano.com>).

Features of SHIMANO STEPS

- **Lightweight, compact design**
- **Silent, smooth ride**
- **High shifting performance system (In the case of electronic gear shifting)**

This system uses accurate sensors to enable shifting gears by providing the most appropriate level of power assistance carefully adjusted by computer controls.

- **Full Automatic Shifting (In the case of electronic 8/5-speed gear shifting)**

The sensors detect riding conditions, whether you are riding up a hill against the wind, or on flat ground with no wind; the automatic gear shifting system uses computer controls to make your ride more pleasant.

- **Start mode (In the case of electronic gear shifting)**

This function allows automatic shifting down to a preset gear when you stop the bicycle such as at traffic lights so that you can start traveling at a light gear.

* If, while the bicycle is stopped, you shift to a gear lower than the set gear, the system will not automatically shift up.

- **Coaster brake compatible**

Smoothly provides sufficient control power.

- **Light off road**

Sporty, provides powerful assistance. Can only be used when set by the manufacturer of the completed bicycle.



- **Walk assistance function (Walk assist mode)**

* The Walk assist mode function may not available in certain regions.

* Some of the functions listed above can only be used once the firmware has been updated. If this is the case, consult the place of purchase, and carry out the firmware updates.

■ Assist mode

You can select a SHIMANO STEPS assist mode for each particular application.

| [HIGH] | [NORM] (Normal) | [ECO] |
|--|--|---|
|  |  |  |
| Steep uphill slopes. | Gentle slope or level ground. | Long distance riding on level ground. |
| When the battery level is running low, the level of assistance is lowered to increase the traveling range. | | |
| [OFF] | | |
| <ul style="list-style-type: none"> • When you don't need power assistance • When you are concerned about remaining battery power | | |
| [WALK] | | |
| <ul style="list-style-type: none"> • When you walk while pushing the E-BIKE loaded with heavy baggage • When walking the E-BIKE out of an underground bicycle parking garage | | |
| * This mode may not be available in certain regions | | |

Start your SHIMANO STEPS

SHIMANO STEPS E5000 is compatible with the following types of components in addition to those listed here.

- Cycle computer SC-E7000
- Switch unit SW-E7000
- Frame built-in battery BT-E8020

For details on display and operation, refer to "Operation."

For details on the battery, refer to "Preparation."

1. Charge the battery.

It is possible to charge the battery even while it is mounted on the bicycle.

For details, see "Charging the battery while installed on the bicycle."

< Down-tube mount type battery >

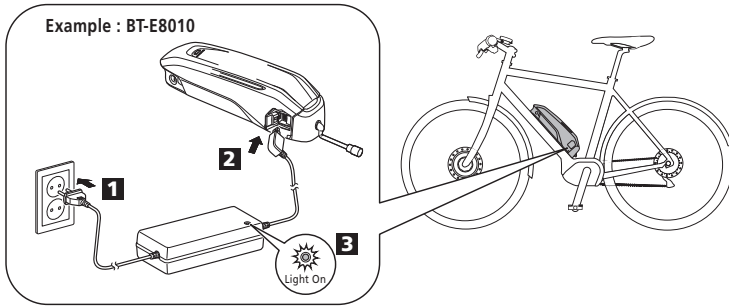

< Rear carrier mount type battery >

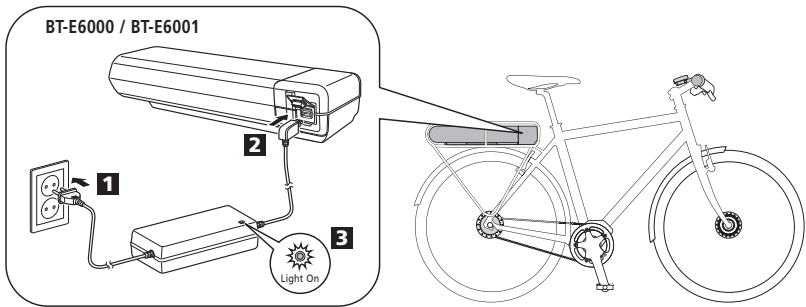

| | |
|----------------|--|
| ● Lights up | Charging (Within 1 hour after the completion of charging) |
| ● Flashing | Charging error |

2. Turn on the power.

To turn off the power, repeat this procedure.

< Down-tube mount type battery >

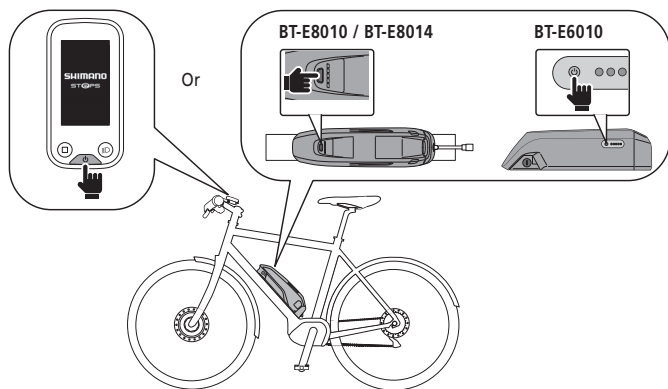

< Rear carrier mount type battery >

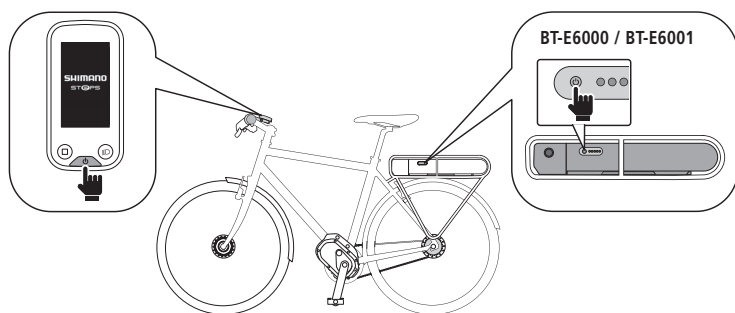

NOTICE

When turning the power ON/OFF, do not place your foot on the pedal.

3. Select your preferred assist mode.

The bicycle is equipped with either SC-E6100 or EW-EN100.

* When the power is turned on, assist mode is set to [OFF].

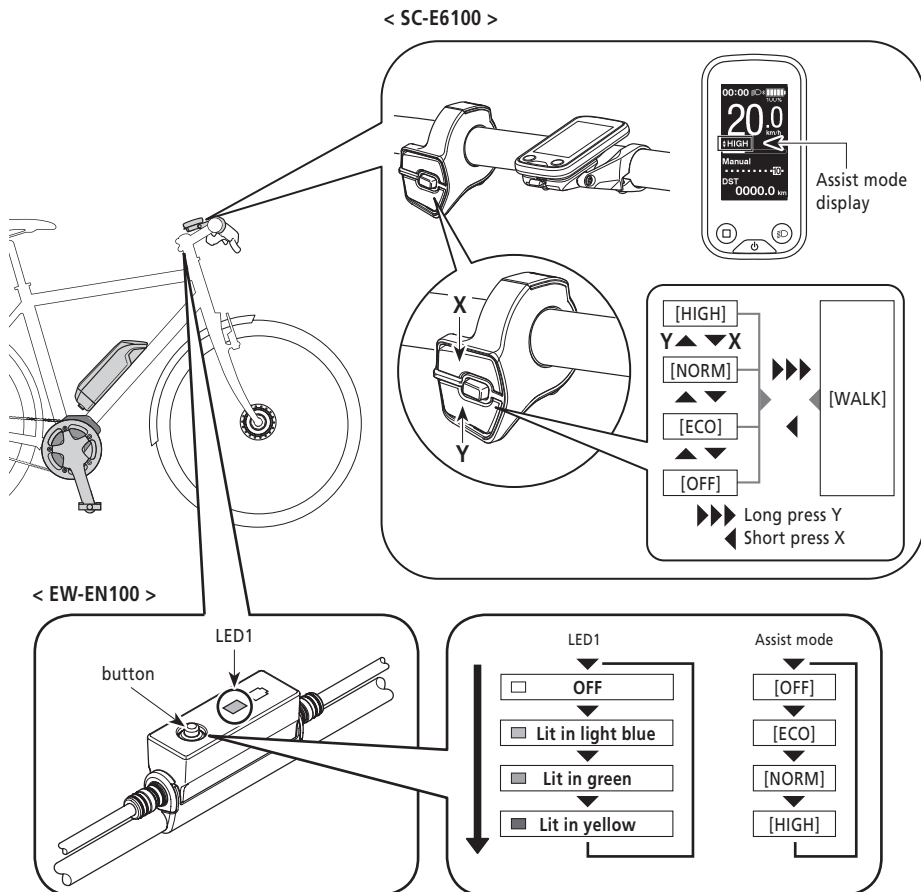

* To change to the [WALK] assist mode, it is necessary to use the above assist switch.

4. Ride the bicycle.

Assist will start when you start pedaling.

CAUTION

SHIMANO STEPS supports various brake systems.

Before riding, please check the brake system of your bicycle and how to operate it beforehand.

5. Turn off the power.

Names of parts

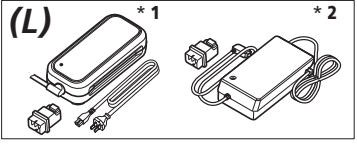
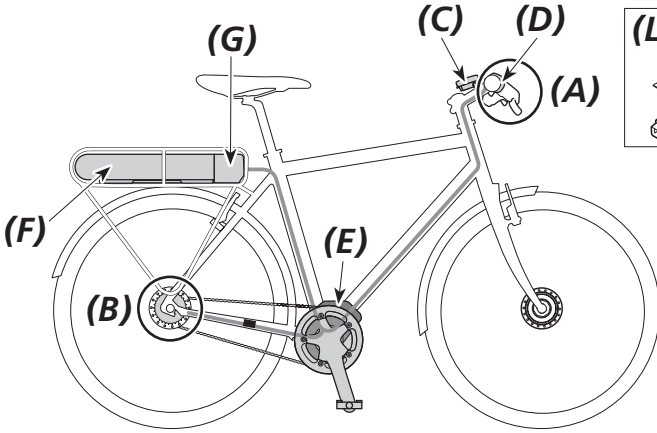

< For electronic gear shifting >

| | | |
|------------|-----------------|--|
| (A) | Shifting switch | <ul style="list-style-type: none"> • SW-E6010 • SW-E7000 |
| | (B) | Motor unit + Internal geared hub Rear Derailleur (D12) |

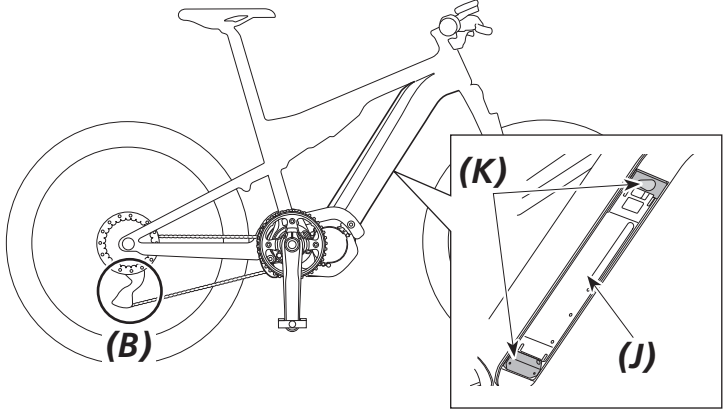
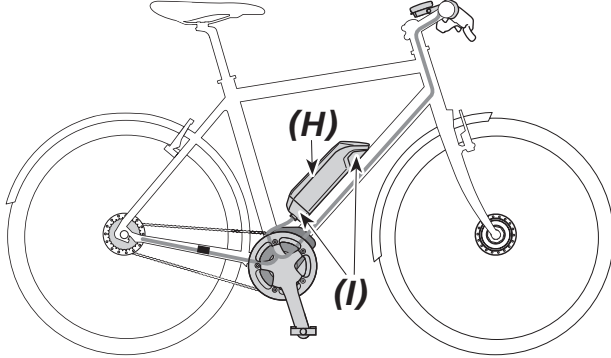
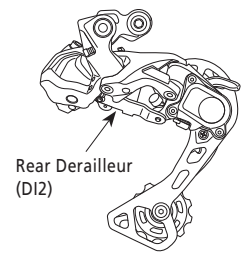
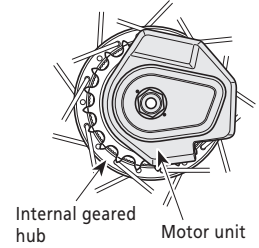

| | | | | | |
|------------|---|--|------------|--|---|
| (C) | Cycle computer / Junction [A] | <ul style="list-style-type: none"> • SC-E6100 • SC-E7000 • EW-EN100 | (H) | Battery (down-tube mount type) | <ul style="list-style-type: none"> • BT-E6010 • BT-E8010^{*3} • BT-E8014 |
| (D) | Assist switch | <ul style="list-style-type: none"> • SW-E6010 • SW-E7000 | (I) | Battery mount (down-tube mount type) | <ul style="list-style-type: none"> • BM-E6010 • BM-E8010 |
| (E) | Drive unit | <ul style="list-style-type: none"> • DU-E5000 | (J) | Battery (Integrated type) | <ul style="list-style-type: none"> • BT-E8020 |
| (F) | Battery (rear carrier mount type) | <ul style="list-style-type: none"> • BT-E6000 • BT-E6001^{*3} | (K) | Battery mount (Integrated type) | <ul style="list-style-type: none"> • BM-E8020 |
| (G) | Battery mount (rear carrier mount type) | <ul style="list-style-type: none"> • BM-E6000 | (L) | Battery charger * 1: EC-E6002 + SM-BCC1 + SM-BTE60 * 2: EC-E6000 + SM-BTE60 | |

*3 If the firmware version of the drive unit is 3.2.6 or lower, the battery may not operate properly. Update the firmware version via E-TUBE PROJECT.

Specifications

| | | | |
|--|--|-------------------------------|--|
| Operating temperature range: During discharge | -10 – 50°C | Battery type | Lithium ion battery |
| Operating temperature range: During charging | 0 – 40°C | Nominal capacity | Please read the SHIMANO STEPS special battery and parts user's manual. |
| Storage temperature | -20 – 70°C | Rated voltage | 36 V DC |
| Storage temperature (Battery) | -20 – 60°C | Drive unit type | Midship |
| Charging voltage | 100 – 240 V AC | Motor type | Brush-less DC |
| Charging time | Please read the SHIMANO STEPS special battery and parts user's manual. | Rated drive unit power | 250 W |

* The maximum speed for which power assistance is provided is set by the manufacturer and is conditional on where the bicycle is to be used.

Preparation

You cannot use the battery immediately after shipment.

The battery can be used after charging it with the designated charger.

Be sure to charge it before use. The battery can be used when the LED on it lights up.

Please read the SHIMANO STEPS special battery and parts user's manual for the latest information about charging and handling the battery.

■ Charging the battery

Charging time varies depending on the remaining capacity of the battery and the charger used. For the designated charging time, refer to the charger user manual.

DANGER

- Use the battery and charger combination specified by the company for charging and follow the charging conditions specified by the company. Not doing so may cause overheating, bursting, or ignition of the battery.

CAUTION

- When charging the battery while it is mounted on the bicycle, be careful not to trip over the charger cord or get anything caught on it. This may lead to injury or cause the bicycle to fall over, damaging the components.

NOTICE

- When removing the battery charger power plug from the outlet or the charging plug from the battery, do not pull it out by the cord, or it causes breakage.
- If the bicycle is stored for an extended period of time immediately after purchase, you will need to charge the battery before using the bicycle. Once the battery is charged, it starts to deteriorate.
- Connect to E-TUBE PROJECT and click [Connection check] to confirm whether the battery in use is a genuine SHIMANO battery or another brand.
- Charge the batteries on a flat surface indoors.

Charging the battery that removed from the bicycle

BT-E6000/BT-E6001/BT-E6010

Adapter (SM-BTE60) is necessary to charge BT-E6000/BT-E6001/BT-E6010 when removed from the bicycle.

1. Attach the adapter to the charging plug.
2. Connect the charger's power plug to the outlet.
3. Connect the adapter to the battery's charging port.

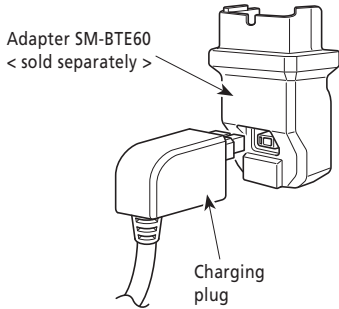

< BT-E6000/BT-E6001 >

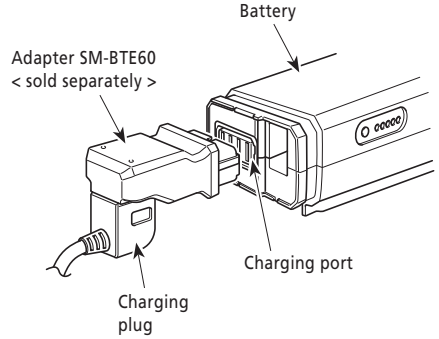

< BT-E6010 >

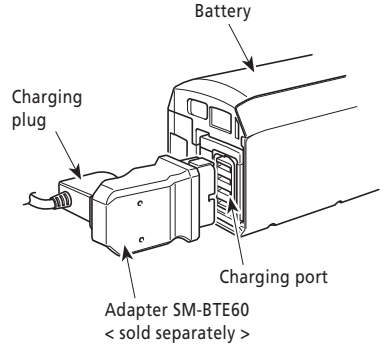

BT-E8010/BT-E8014/BT-E8020

- 1.** Connect the battery charger's power plug to the outlet.
- 2.** Connect the charging plug into the battery's charging port.

< BT-E8010/BT-E8014 >

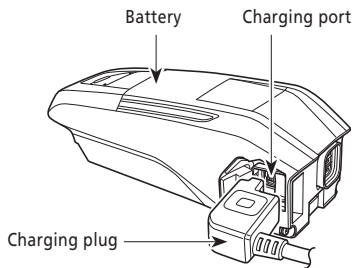

< BT-E8020 >

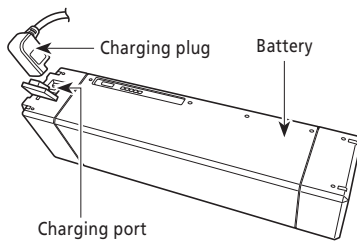

Charging the battery while installed on the bicycle

- Place the battery charger on a stable surface such as the floor before charging.
- Stabilize the bicycle to ensure that it does not collapse during charging.

1. Connect the battery charger power plug to the outlet.

2. Connect the charging plug to the charging port on the battery mount or the battery.

< BT-E6000/BT-E6001 >

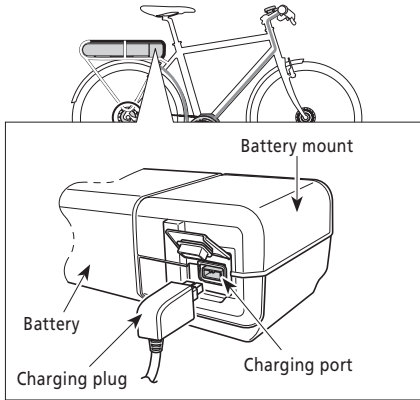

< BT-E8020 >

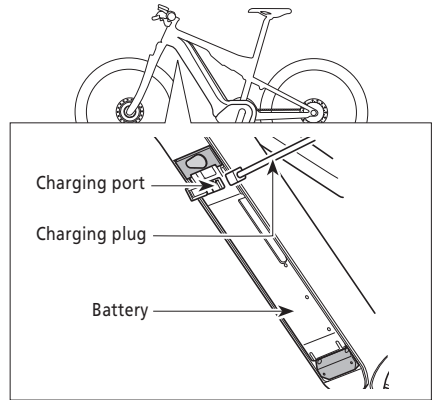

< BT-E6010/BT-E8010/BT-E8014 >

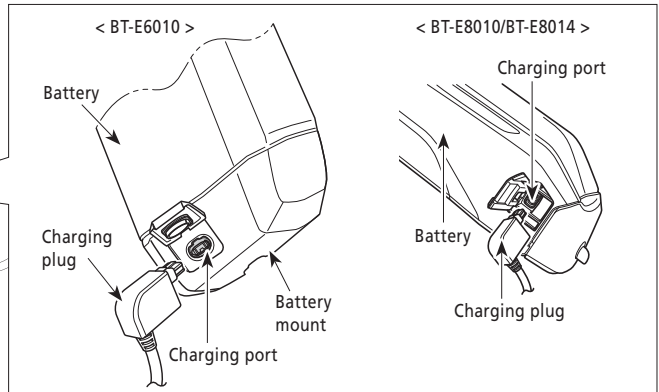

< BT-E8010/BT-E8014 >

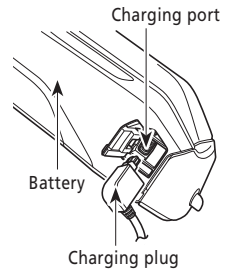

3. After charging, close the charging port cap securely.

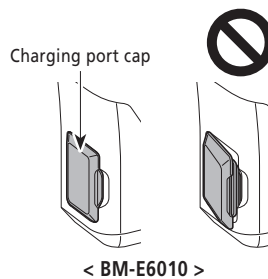
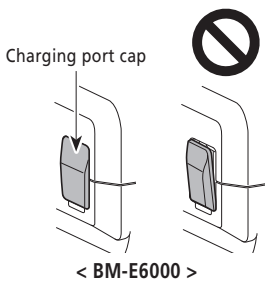

■ Charger LED lamp

After charging has started, the LED lamp on the charger will light up.

| | |
|-----------------|----------------------|
| ○ Lit up | Charging |
| ☀ Blinking | Charging error |
| ● Turned off | Battery disconnected |

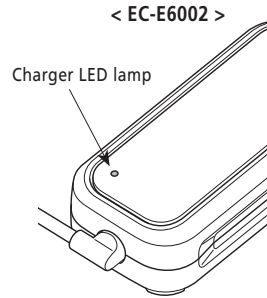
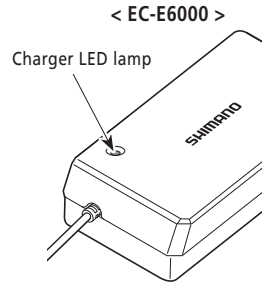

■ Battery LED lamp

Use this to check the current charging status.

The shape of the battery LED lamp varies depending on the model number.

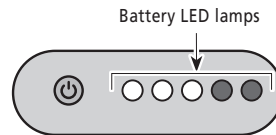

Charging-in-progress indication

While battery is charging, the LED lamps on the battery light up.

| LED lamp indication*1 | Battery level |
|-----------------------|---------------|
| ☀ ● ● ● ● | 0 - 20% |
| ○ ☀ ● ● ● | 21 - 40% |
| ○ ○ ☀ ● ● | 41 - 60% |
| ○ ○ ○ ☀ ● | 61 - 80% |
| ○ ○ ○ ○ ☀ | 81 - 99% |
| ○ ○ ○ ○ ○ | 100% |

*1 ● : Not lit ○ : Lit up ☀ : Blinking

Battery level indication

The current battery level can be checked by pressing the battery's power button.

| LED lamp indication*1 | Battery level |
|-----------------------|---|
| ○ ○ ○ ○ ○ | 100 - 81% |
| ○ ○ ○ ○ ● | 80 - 61% |
| ○ ○ ○ ● ● | 60 - 41% |
| ○ ○ ● ● ● | 40 - 21% |
| ○ ● ● ● ● | 20 - 1% |
| ☀ ● ● ● ● | 0% (When battery is not installed on bicycle) |
| ● ● ● ● ● | 0% (When battery is installed on bicycle) Power off / Shutdown |

*1 ● : Not lit ○ : Lit up ☀ : Blinking

NOTICE

When remaining battery capacity is low, system functions begin to shut off in the following order.

1. Power assistance (Assist mode automatically switches to [ECO] and then assistance shuts off. The switch to [ECO] occurs earlier if a battery-powered light is connected.)
2. Gear shifting
3. Light

■ Handling the battery

Charging can be carried out at any time regardless of the amount of charge remaining, but you should fully charge the battery at the following times. Be sure to use the special charger when recharging the battery at these times.

- The battery is not fully charged at the time of purchase. Before riding, be sure to charge the battery until it is fully charged.

If the battery has become fully spent, charge it as soon as possible. If you leave the battery without charging it, it will cause the battery to deteriorate.

- If the bicycle will not be ridden for a long period of time, store it away with approximately 70% battery capacity remaining. In addition, take care not to let the battery become completely empty by charging it every 6 months.

■ Installing and removing the battery

The battery is secured to the battery mount with the key.

The following description may not be applicable, as different types of keys are available.

Installation of the battery

CAUTION

- Hold the battery firmly and be careful to prevent dropping when installing.
- Pay attention to the following to prevent the battery from falling while riding the bicycle:
 - Make sure the battery is locked securely on the battery mount.
 - Do not ride the bicycle with the key inserted.

NOTICE

Before riding, make sure that the charging port cap is closed.

BT-E6000/BT-E6001

1. Insert the battery in the battery mount rail from behind.
 - Slide the battery forward, and then push it in firmly.
2. Remove the key.
 - Return the key to the locked position and then remove the key.

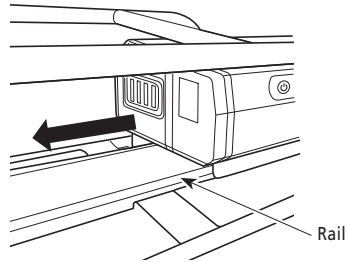

BT-E6010/BT-E8010/BT-E8014

1. Insert the battery from bottom side.
 - Align the indentation in the bottom of the battery with the protrusion on the battery mount.

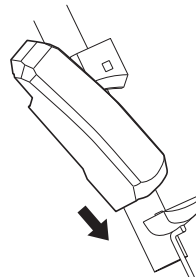

- 2.** Slide the battery.
 - Push in the battery until there is a click.
- 3.** Remove the key.
 - Return the key to the locked position and then remove the key.



BT-E8020

This procedure is an example using a frame whose battery is removed/installed from below.

- 1.** Insert the battery from bottom side.
- 2.** Slide the battery.
 - Push in the battery until there is a click.

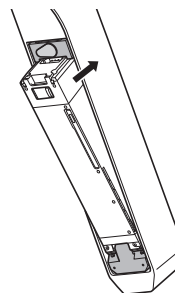

Removing the battery

CAUTION

- Hold the battery firmly and be careful to prevent dropping when removing or carrying it.

BT-E6000/BT-E6001

The position of the key does not affect the insertion of the battery. You can insert it regardless of the key position.

1. Insert the Key.

Turn off the power, then insert the key into the key cylinder in the battery mount.

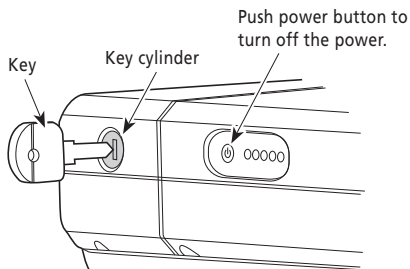

2. Turn the key until you feel some resistance.

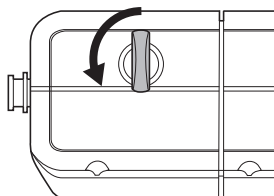

3. Remove the battery carefully.

You can remove the battery only when the key is in the unlocked position.

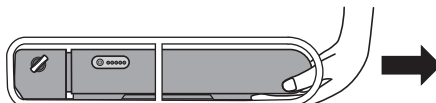

BT-E6010/BT-E8010/BT-E8014

1. Insert the Key.

Turn off the power, then insert the key into the key cylinder in the battery mount.

< BT-E6010 >

Push power button to turn off the power.

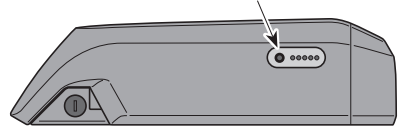

< BT-E8010/BT-E8014 >



Push power button to turn off the power.

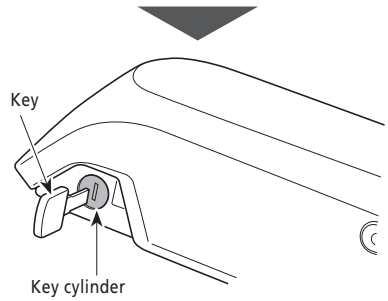

2. Turn the key until you feel some resistance.

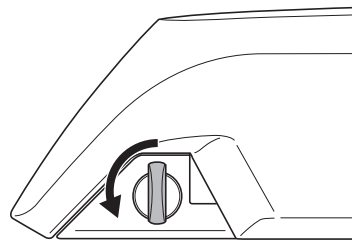

3. Remove the battery

- Slide the battery, then remove it carefully.
- You can remove the battery only when the key is in the unlocked position.

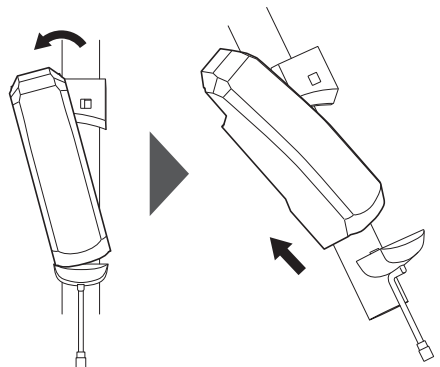

BT-E8020

- This procedure is an example using a frame whose battery is removed/installed from below.
- If using a battery cover manufactured by another company, remove the battery cover before removing the battery.

1. Open the keyhole cap.

Turn off the power, then open the keyhole cap.

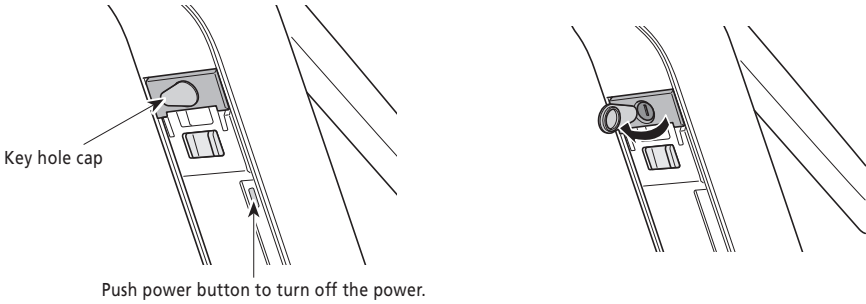

2. Unlock the battery.

(1) Insert the key into the key cylinder in the battery mount.

(2) Turn the key.

The battery is unlocked. The plate spring holds the battery in place, preventing it from falling out.

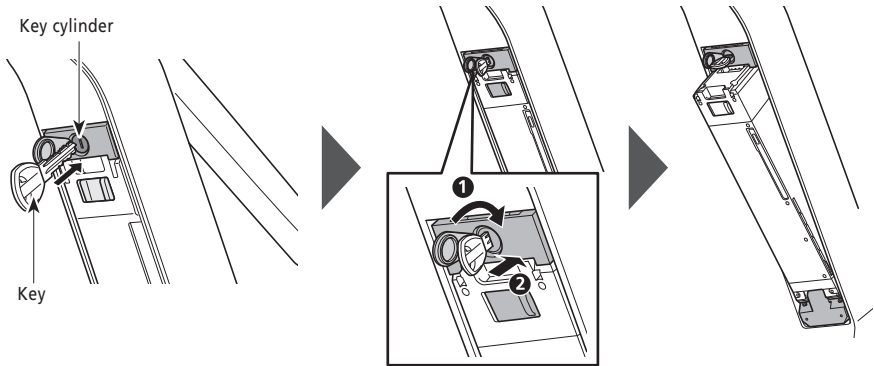

3. Remove the battery.

(1) Remove the key, then close the keyhole cap.

(2) Remove the battery carefully.

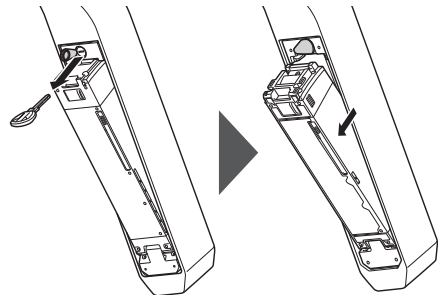

NOTICE

Do not install or remove the battery with the key left inserted on the battery mount or the keyhole cap left open.
The battery may be damaged if it comes into contact with the top (grip portion) of the key.

■ Installing and removing the cycle computer (SC-E6100)

The cycle computer can also be secured to the bicycle so that it cannot be easily removed. Please contact your place of purchase for details.

Installing

1. Slide the cycle computer onto the bracket.
2. Insert the cycle computer securely until it clicks into place.

NOTICE

If the cycle computer is not correctly installed, the assist function will not operate normally.

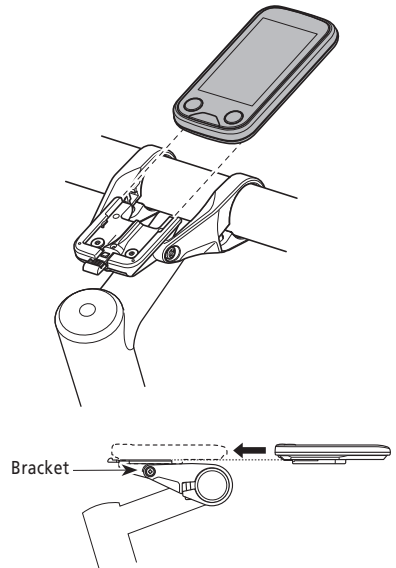

Removing

1. Slide out the cycle computer.
 - Push the lever firmly to release the cycle computer.

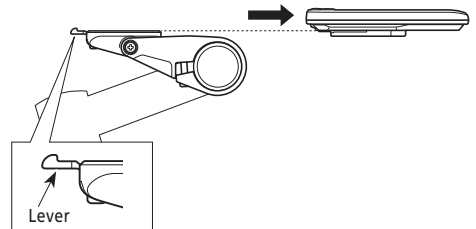

Operation

■ Turning the power ON / OFF

- The power cannot be turned on while charging.
- If the bicycle has not moved for over 10 minutes, the power will automatically turn off (automatic power off function).
- If using SC-E7000, the power supply is operated from the battery.

NOTICE

Do not place your foot on the pedals when turning ON/OFF. This may cause a system error.

Turning the power ON and OFF via the cycle computer (SC-E6100)

- If the built-in battery of the cycle computer isn't charged sufficiently, it will not power on.
- The built-in battery of the cycle computer only charges when the cycle computer screen is on.

1. Press the power switch.

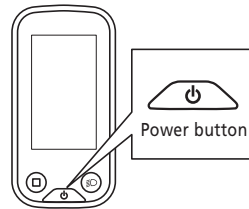

Turning the power ON and OFF via the battery

It is possible to forcibly power off BT-E8010/BT-E8020 by holding down the power button for 6 seconds.

1. Press the power button on the battery. The LED lamps will light up indicating remaining battery capacity.

NOTICE

When turning on the power, check that the battery is firmly attached to the battery mount.

< BT-E6000/BT-E6001 >

Power button

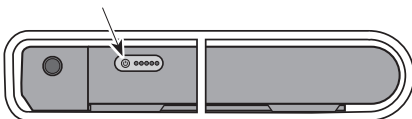

< BT-E8010/BT-E8014 >

Power button

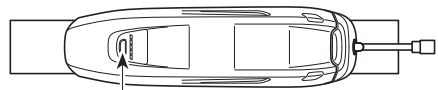

< BT-E6010 >

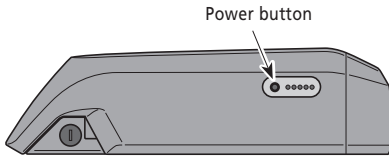

< BT-E8020 >

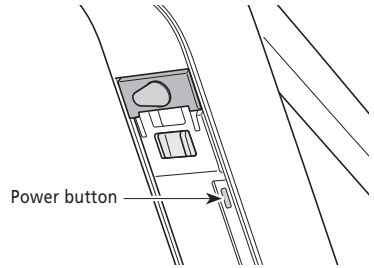

Screen display when power is turned ON

SC-E6100

When the power is turned ON, a screen similar to that shown below is displayed, and then switches to the basic screen.

Normal startup



Battery level too low



* The level of the cycle computer's built-in battery is too low.

Turning the power ON with the cycle computer connected to the bicycle will charge the cycle computer's built-in battery.

SC-E7000

This screen appears when the power is turned ON.



EW-EN100

The LED2 turns ON.

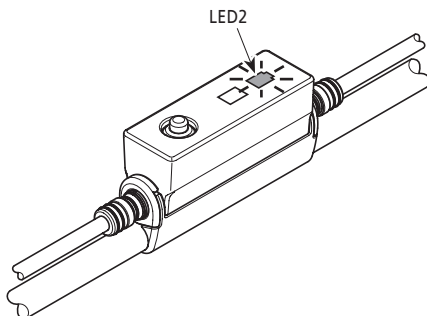

Basic operation

It is possible to change assigned functions for individual switches. For details, please consult with the dealer from which you purchased the product.

Cycle computer and switch units

SC-E6100/SW-E6010

Left switch

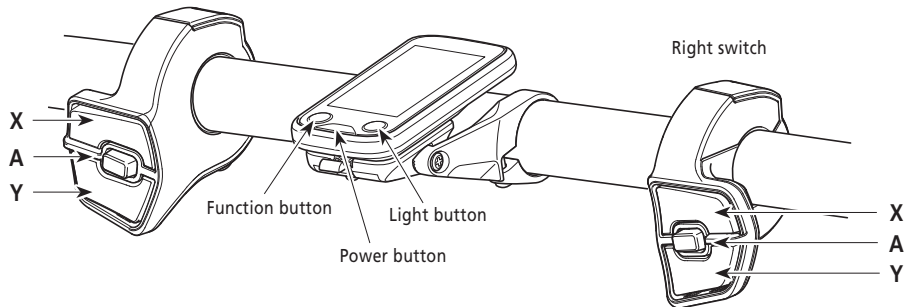

SC-E7000/SW-E7000

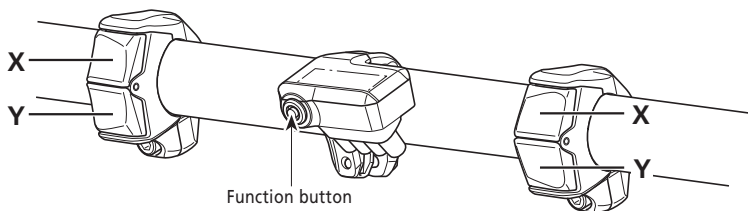

| Left switch (default: for assistance) | | Right switch (default: for electronic shifting) | |
|--|---|--|---|
| Assist-X | When riding: increase assistance. When setting: move the setting menu cursor, adjust settings, etc. | Shift-X | When riding: shift gears to increase pedal resistance. |
| Assist-Y | When riding: decrease assistance. When setting: move the setting menu cursor, adjust settings, etc. | Shift-Y | When riding: shift gears to decrease pedal resistance. |
| Assist-A | When riding: change the travel data display on the cycle computer. When setting: switch between the screens, confirm settings. | Shift-A | When riding: switch between automatic and manual gear shifting (for electronic internal geared hub). |

| Cycle computer (SC-E6100) | | | |
|---------------------------|---|--------------|-------------------------|
| Function button | When riding: change the travel data display on the cycle computer. When setting: switch between the screens, confirm settings. | Light button | Turn the lights ON/OFF. |
| | | Power button | Turn the power ON/OFF. |

| Cycle computer (SC-E7000) | |
|---------------------------|---|
| Function button | When riding: change the travel data display on the cycle computer. When setting: switch between the screens, confirm settings. |

NOTICE

When the bicycle uses a rear derailleur, be sure to shift gears while pedaling.

Junction [A] (EW-EN100)

EW-EN100 is used instead of cycle computer.

It is attached to the brake outer casing or brake hose and located near the handle bar.

- It is not recommended to operate the button on EW-EN100 while riding. Please select your preferred assist mode before riding.
- For other functions assigned to the button, see "Settings (EW-EN100)."

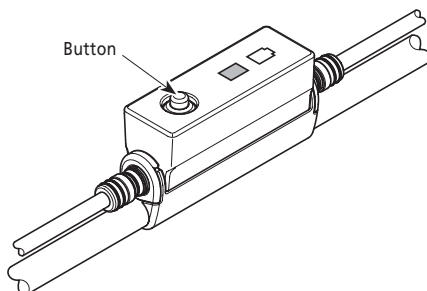

Junction [A]

| | |
|--------|--|
| Button | Press: change the assist mode each time you press it. Press and hold (about 2 seconds): turn the light ON/OFF |
|--------|--|

■ Turning the light ON / OFF

- If your bicycle has the lights connected to drive unit, the lights can operate from the cycle computer or junction [A].
- The light turns off in conjunction with the battery power. When the battery power is off, the light is off.
- If using SC-E7000, the light is operated from the setting menu. For details, refer to "[Light] Light ON/OFF (SC-E7000 only)."

SC-E6100

1. Press the light button.

- Lights are turned on.
- To turning off the lights, push the button again.

* When the battery powered light is not connected and [Backlight] is set to [MANUAL], pressing the light button turns the cycle computer's backlight on and off.

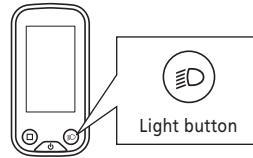

When the light is turned on



When the light is turned off



EW-EN100

You cannot turn the light off while riding the bicycle.

- #### 1. Press and hold (about 2 seconds) the button until the lights turn ON/OFF.
- LED1 blinks green.

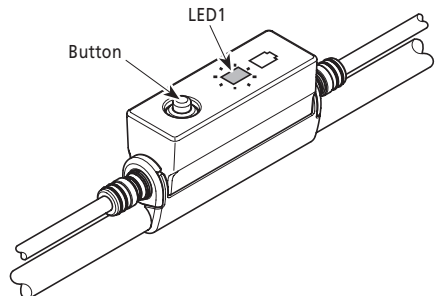

■ Basic status display

Displays the status of your bicycle and travel data.

The gear position is only displayed when using electronic gear shifting.

(A) Battery level indicator

(B) Maintenance alert

Indicates that maintenance is required. Contact your place of purchase or a bicycle dealer if this icon is displayed.

(C) Gear position display

< SC-E6100 >

Current gear position

Start mode gear position*1

Shifting advice*2

This notifies you of the recommended timing at which to shift based on the bicycle riding conditions.

(D) Travel data display

(E) Gear shifting mode*1*3

Displays current gear shifting mode as [Auto] or [Manual].

(F) Assist gauge

Displays assistance level.

(G) Current assist mode

(H) Current speed*4

(I) Current time

(J) Light icon

Indicates that the light connected to the drive unit is lit.

(K) Bluetooth® LE icon

Displayed when connected over Bluetooth LE.

*1 Only for electronic gear shifting with internal geared hub.

*2 Only for electronic gear shifting with the gear shifting mode set to [Manual].

*3 [Manual] will always be displayed for rear derailleur models.

*4 For SC-E7000, the traveling data displayed in this location can be changed.

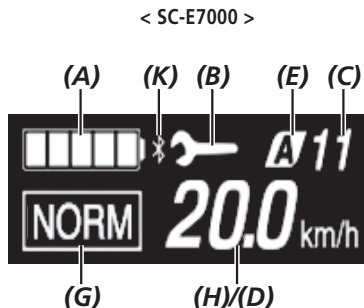
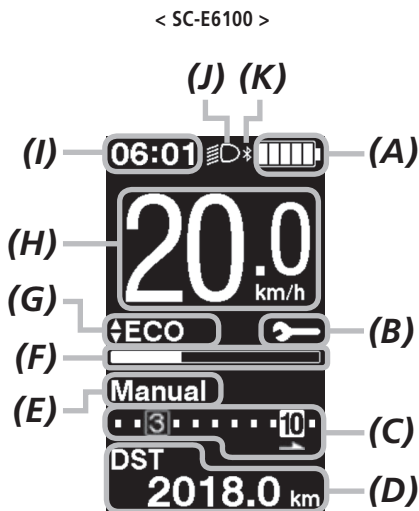

LED lamps indicate the following status.

- Current battery level
- Current assist mode

For details, see "Battery level indicator" and "Changing the assist mode."

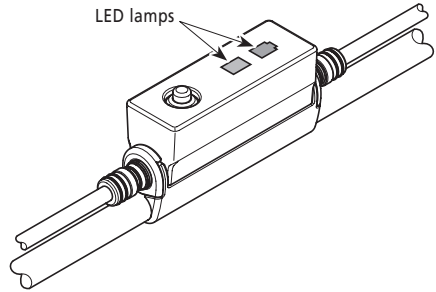

Battery level indicator

You can check the battery level while riding.

SC-E6100/SC-E7000

| Display | Battery level |
|---------|---------------|
| | 100 - 81% |
| | 80 - 61% |
| | 60 - 41% |
| | 40 - 21% |
| | 20 - 1%* |
| | 0% |



* For SC-E7000, the battery level indicator will flash when the battery level is low.



The cycle computer uses zero to indicate a battery level where assistance cannot be performed. With the SHIMANO STEPS system, the light can still be lit up for a while when assist stops due to a low battery. Therefore, the above-mentioned battery level may differ from that which can be checked on the battery.

EW-EN100

While power is turned on, the outer side LED2 indicates the battery level.

| LED2 indication | Battery level |
|--|---------------|
|  (Lit in green) | 100 - 21% |
|  (Lit in red) | 20% or less |
|  (Blinking red) | Nearly empty |

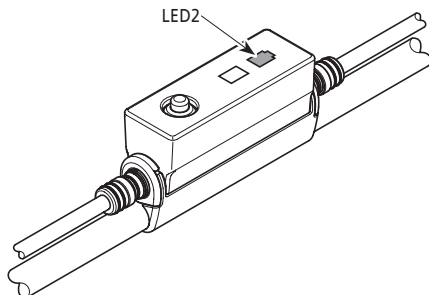

■ Changing the assist mode

Changing the assist mode with switch unit

1. Press Assist-X or Assist-Y.

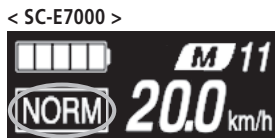
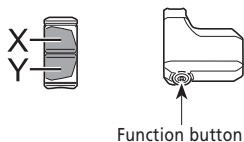
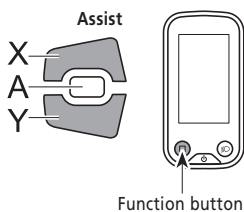

* If using SC-E7000 and there is no assist switch, you can also hold the function button down to switch the assist mode. However, it cannot be switched to [WALK] mode.

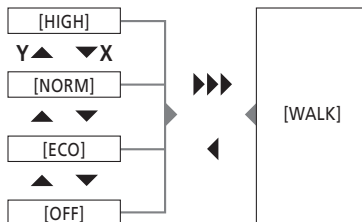

▶▶▶ Long press Y
◀ Short press X

Changing the assist mode with EW-EN100

1. Press button.

Assist mode is changed each time you press it.

The LED1 indicates current assist mode.

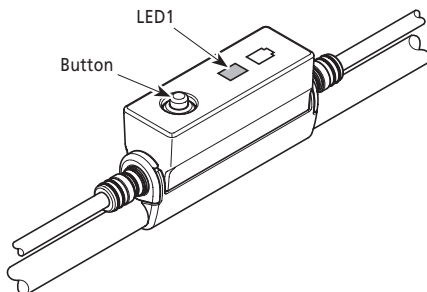
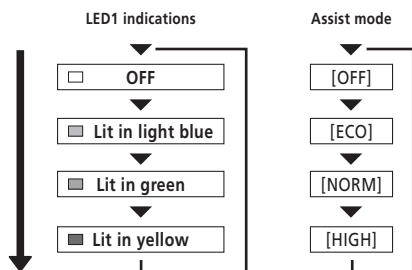

■ Walk assist mode

- This mode may not be available in certain regions.
- The walk assist function operates at a maximum of 6 km/h. During electronic gear shifting, the assist level and speed are controlled by the gear position.
- If Assist-Y is not pressed for at least one minute, the system will restart in the mode that was set prior to setting [WALK] mode.
- The intelligent walk assist function activates when an electric shifting system such as XTR, DEORE XT SEIS is connected. System individually supplies assist power to detect gear position.
"Intelligent walk assist" support rider more torque output in steep climb condition in lower side gears.
"Quick walk assist" function works quickly by holding down SW from any mode.

Switch to walk assist mode

1. Press and hold Assist-Y (about 2 seconds) until the following occurs.

SC-E6100/SC-E7000: [WALK] is displayed on the screen

EW-EN100: LED1 lights up blue



NOTICE

A warning tone will sound while switching is in progress if it is not possible to switch to [WALK] mode because the current speed is not [0 km/h] or there is pressure on the pedals etc.

< SC-E6100 >

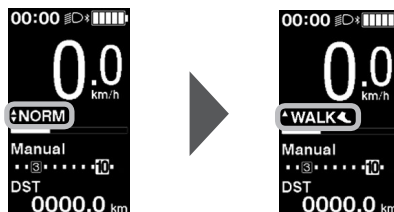

< SC-E7000 >



< EW-EN100 >

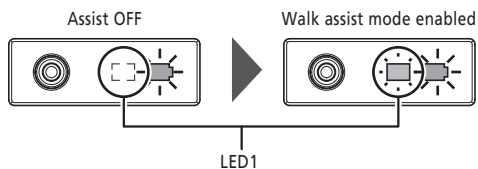

Operation of walk assist function

1. While in walk assist mode, press and hold down Assist-Y.
 - Start the walk assist function.
 - If Assist-Y is not operated for over 1 minute, the assist mode will change to [OFF].
 - If the switch unit is connected to EW-EN100, the LED lamp (inner side) blinks blue when the above operation is performed.
2. Hold the handlebar and push the bicycle carefully.
3. To stop the walk assist function, release Assist-Y.
4. To exit the walk assist mode, press the Assist-X button.

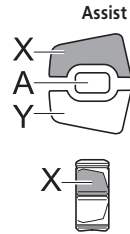
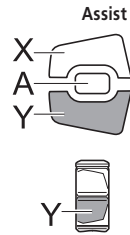

■ Switching the travel data display (SC-E6100)

1. The type of travel data displayed changes each time you press Assist-A or the cycle computer's function button.

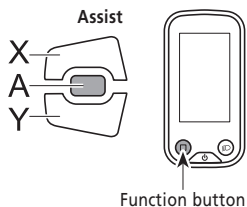

| Display item | Description |
|--------------|---|
| [DST] | Traveling distance |
| [ODO] | Cumulative distance |
| [RANGE] | Traveling range *1 |
| [RANGE] | Traveling range for each assist mode *1 *2 *3 |
| [TIME] | Traveling time *3 |
| [AVG] | Average speed *3 |
| [MAX] | Maximum speed *3 |
| [CADENCE] | Crank rotation speed *3 *4 |

*1 Traveling range figures are approximations to be used for reference purposes only.

*2 This data is displayed as follows. Gear shifting mode and gear position are not displayed.

| RANGE | |
|-------|-------|
| HIGH | 61 km |
| NORM | 77 km |
| ECO | 97 km |

*3 Optional item: You can configure the display settings in E-TUBE PROJECT. For details, refer to the "Connection and communication with devices."

*4 Cadence is only displayed when pedaling is assisted while using electronic gear shifting.

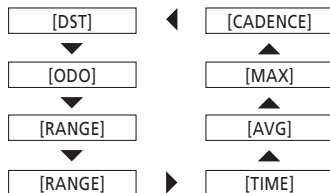

Clearing the traveling distance (SC-E6100)

You can clear the traveling distance in the main screen. When the traveling distance is cleared, [TIME] (traveling time), [AVG] (average speed), [MAX] (maximum speed) are also cleared. This operation can only be used when SW-E6010 is being used.

1. Press Assist-A or function button to change the travel data display to [DST].

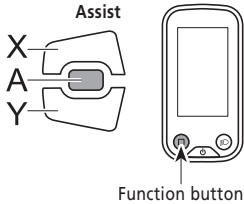

2. Press and hold down Assist-A or the function button until the value below the [DST] display blinks.

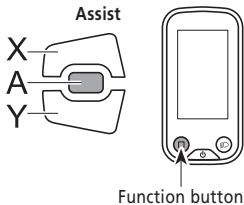

3. Press Assist-A or the function button again.
 - Travel data is cleared.
 - The [DST] value stops blinking and the screen takes resets to the basic screen after being left alone for 5 seconds.

■ Switching the travel data display (SC-E7000)

The type of displayed traveling data changes each time you press the function button, beginning with [DST]. If nothing is done within 60 seconds, the screen will automatically switch back to displaying the current speed.

- If using SW-E6010, control is also possible with Assist-A.

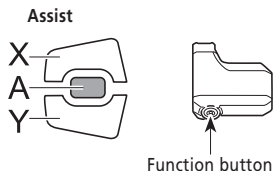

| Display item | Description |
|--------------|----------------------------|
| - | Current speed |
| [DST] | Traveling distance |
| [ODO] | Cumulative distance |
| [RNG] | Traveling range *1*3 |
| [TME] | Traveling time *2 |
| [AVG] | Average speed *2 |
| [MAX] | Maximum speed *2 |
| [CAD] | Crank rotation speed *2 *4 |
| [CLK] | Current time *2 |

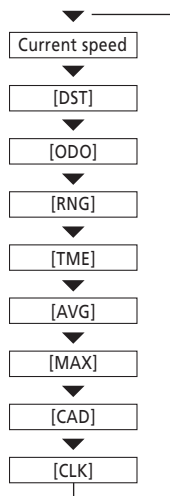

*1 When [RNG] is displayed, the battery level is not displayed. The traveling range should be used as a reference only.

*2 Optional item: You can configure the display settings in E-TUBE PROJECT. For details, refer to the "Connection and communication with devices" section.

*3 When walk assistance is functioning, the on screen display [RNG] changes to [RNG ---].

*4 Cadence is only displayed when pedaling is assisted while using electronic gear shifting.

Clearing the traveling distance (SC-E7000)

You can clear the traveling distance in the main screen. When the traveling distance is cleared, [TME], [AVG] and [MAX] are also cleared.

1. Change the traveling data display to [DST] and press Assist-A or the function button.
2. Release the finger when the [DST] indication starts blinking.
In this state, pressing the function button again clears the traveling distance.
 - The [DST] indicator light stops blinking and the screen takes you back to the basic screen after leaving it alone for 5 seconds.

Switch the gear shifting mode

This function is only for electronic gear shifting by internal geared hub.

1. Press Shift-A at the basic screen.
Each press switches between [Manual] and [Auto].

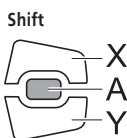

| | |
|----------|---|
| [Auto] | Automatically shift gears according to the pedal load. |
| [Manual] | Manually operate the gear-shift mechanism for electronic gear shifting. |

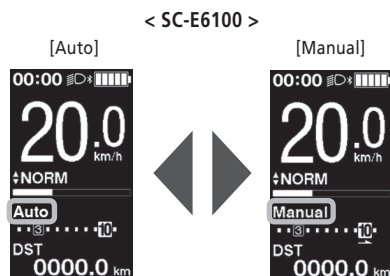

< SC-E7000 >

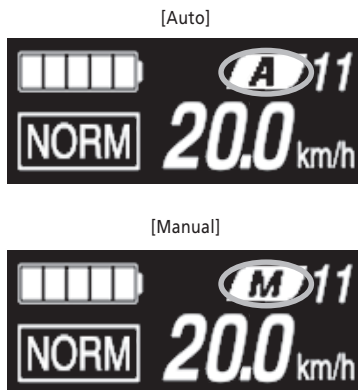

Setting menu

■ Launching (SC-E6100)

1. Stop your bicycle.
2. Perform the following to switch to the setting menu.
 - Ensure that [DST] is not being displayed on the screen, and then hold Assist-A or the function button until the screen switches to the setting menu.
 - Hold down Assist-X and Assist-Y together until the screen switches to the setting menu.

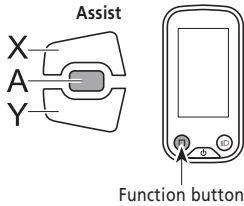

3. Select the menu item.

- (1) Press Assist-X or Assist-Y to move the cursor on setting menu.
- (2) Press Assist-A. If using SW-E7000, press the function button.

The display changes to the selected menu item.

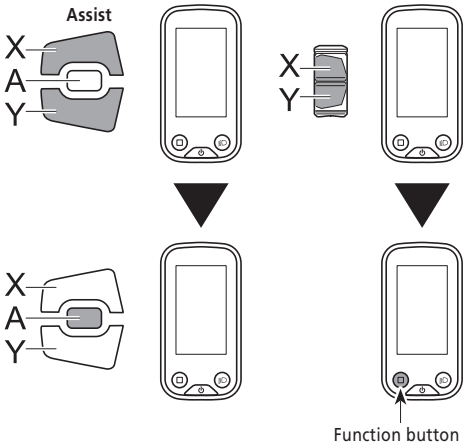

< Basic screen >



< Setting menu screen >

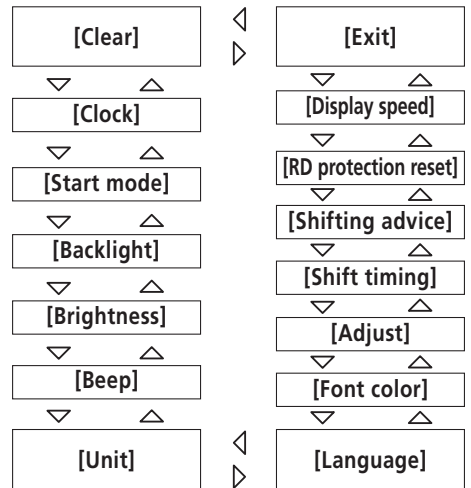

| Configurable items | Details |
|-------------------------------------|---|
| [Clear] | Reset the traveling distance or the setting values. |
| [Clock] | Set the current time. |
| [Start mode] ^{*1} | Set the start gear. |
| [Backlight] | Configure the display backlight. |
| [Brightness] | Set the display brightness. |
| [Beep] | Turning the beep sound ON/OFF. |
| [Unit] | Select between km and miles. |
| [Language] | Set the display language. |
| [Font color] | Select the display character color between black and white. |
| [Adjust] ^{*2} | Adjust the electronic gear shifting unit |
| [Shift timing] | Adjust the shift timing |
| [Shifting advice] | Turning the shifting advice ON/OFF |
| [RD protection reset] ^{*3} | Activating RD protection reset |
| [Display speed] | Adjusts the displayed speed to match another device. |
| [Exit] | Return to the main screen. |

* 1 Only for electronic shifting with internal geared hub

* 2 Only for electronic shifting

* 3 Only for electronic shifting with rear derailleur

■ Launching (SC-E7000)

If assist switch is not connected, the setting menu cannot be displayed.

1. Stop your bicycle.
2. Perform the following to switch to the setting menu.
 - Ensure that [DST] is not being displayed on the screen, and then hold Assist-A or the function button until the screen switches to the setting menu.
 - Hold down Assist-X and Assist-Y together until the screen switches to the setting menu.

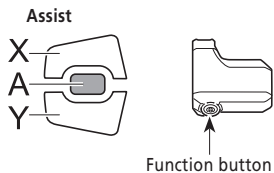

< Basic screen >



< Setting menu screen >



3. Select a menu item.
 - (1) Press Assist-X or Assist-Y to move the cursor on setting menu.
 - (2) Press the function button.

The display changes to the selected menu item. If using SW-E6010, control is also possible with Assist-A.

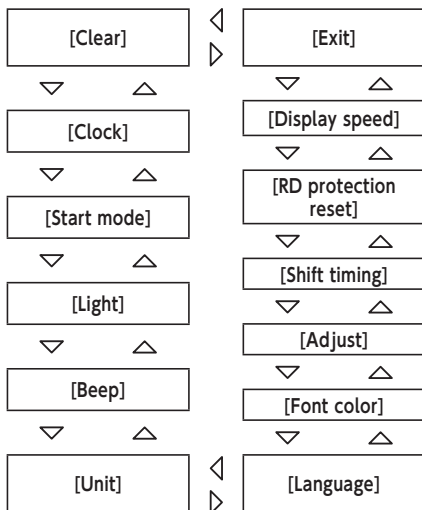
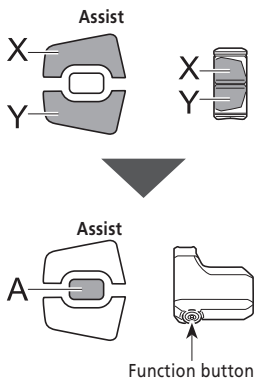

| Configurable items | Details |
|-------------------------|--|
| [Clear] | Clear settings |
| [Clock] | Clock setting |
| [Start mode]*1 | Set the start gear. |
| [Light] | Turning the light on/off |
| [Beep] | Turning the beep noise on/off |
| [Unit] | Switching between km and miles |
| [Language] | Language setting |
| [Font color] | Font color setting |
| [Shift timing]*2 | Adjusting the electronic gear shifting unit |
| [RD protection reset]*3 | Activating RD Protection Reset |
| [Display speed] | Adjusts the displayed speed to match another device. |
| [Exit] | Return to the main screen |

* 1 Only for electronic shifting with internal geared hub

* 2 Only for electronic shifting

* 3 Only for electronic shifting with rear derailleur

■ [Clear] Setting reset

Reset the traveling distance or the setting values.

1. Enter the [Clear] menu.
 - (1) Launch the setting menu.
 - (2) Press Assist-X or Assist-Y to select [Clear], then press Assist-A or the function button.
2. Press Assist-X or Assist-Y to select what you want to reset.

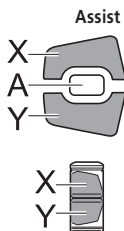

| Configurable items | Details |
|--------------------|--|
| [Exit] | Return to setting menu. |
| [DST] | Reset the traveling distance. When the [DST] (traveling distance) is cleared, [TIME] / [TME] (traveling time), [AVG] (average speed) and [MAX] (maximum speed) are also cleared. |
| [Default]* | Reset the setting values of the cycle computer. |

* SC-E6100 only

Items and default values reset by [Default] are as follows:

- [Backlight]: [ON]
- [Beep]: [ON]
- [Unit]: [km]
- [Language]: [English]
- [Brightness]: [3]
- [Font color]: [White]

< SC-E6100 >



< SC-E7000 >



3. Press the function button to reset the selected item.

If using SW-E6010, control is also possible with

Assist-A.

* The screen will automatically return to the setting menu screen.

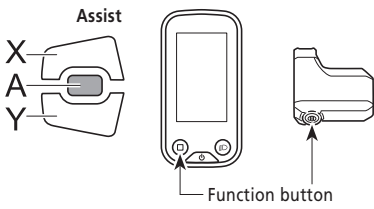

■ [Clock] Time setting

Sets the current time. First set "hour" then "minute."

In step 2 and 4 in below procedure, you can change the values quickly by holding down Assist-X or Assist-Y.

1. Enter the [Clock] menu.

- (1) Launch the setting menu.
- (2) Press Assist-X or Assist-Y to select [Clock], then press Assist-A or the function button.

2. Press Assist-X or Assist-Y to adjust the time.

- Press Assist-X to increase the value.
- Press Assist-Y to decrease the value.

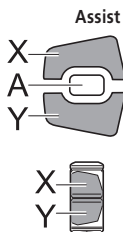

< SC-E6100 >

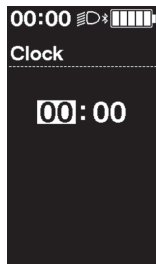

< SC-E7000 >



3. Press Assist-A or the function button to confirm the setting.

The cursor moves to minutes value.

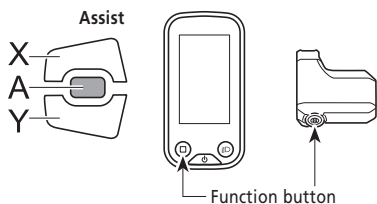

< SC-E6100 >

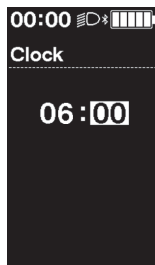

< SC-E7000 >



4. Press Assist-X or Assist-Y to adjust the minutes value.

- Press Assist-X to increase the value.
- Press Assist-Y to decrease the value.

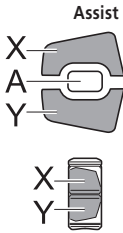

< SC-E6100 >

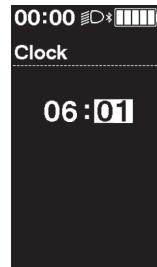

< SC-E7000 >



5. Press Assist-A or the function button to confirm the setting.

- * The screen will automatically return to the setting menu screen.

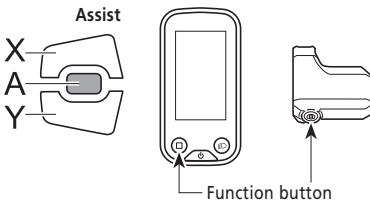

■ [Start mode] Start mode setting

Set the start gear of the start mode function.

It is possible to have the gear automatically shifted to the number set here when you start moving from a standstill.

1. Enter the [Start mode] menu.
 - (1) Launch the setting menu.
 - (2) Press Assist-X or Assist-Y to select [Clock], then press Assist-A or the function button.
2. Press Assist-X or Assist-Y to move the cursor to the item you want to configure.

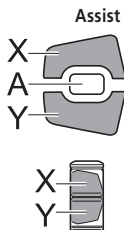

| Configurable items | Details |
|--------------------|--------------|
| [OFF] | No setting |
| [1 - 11] | 1-11-speed * |

* The setting items will vary depending on the internal geared hub being used.

3. Press Assist-A or the function button to confirm the setting.
 - * The screen will automatically return to the setting menu screen.

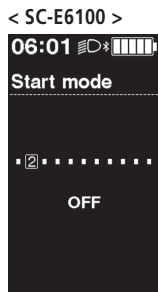
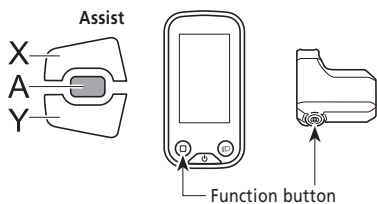

< SC-E7000 >



■ [Backlight] Backlight setting (SC-E6100 only)

Configure the display backlight.

1. Enter the [Backlight] menu.

- (1) Launch the setting menu.
- (2) Press Assist-X or Assist-Y to select [Backlight], then press Assist-A or the function button.

2. Press Assist-X or Assist-Y to move the cursor to the item you want to configure.

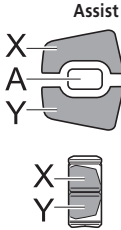

| Configurable items | Details |
|--------------------|--|
| [ON] | Always turned on |
| [OFF] | Always turned off |
| [MANUAL] | Turns on and off in conjunction with the battery-powered light |

3. Press Assist-A or the function button to confirm the setting.

* The screen will automatically return to the setting menu screen.

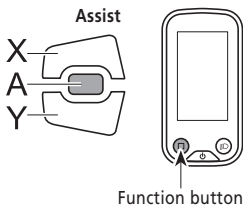

■ [Brightness] Backlight brightness setting (SC-E6100 only)

Set the display brightness.

1. Enter the [Brightness] menu.
 - (1) Launch the setting menu.
 - (2) Press Assist-X or Assist-Y to select [Brightness], then press Assist-A or the function button.
2. Press Assist-X or Assist-Y to adjust the brightness.
Brightness can be adjusted to one of five levels.

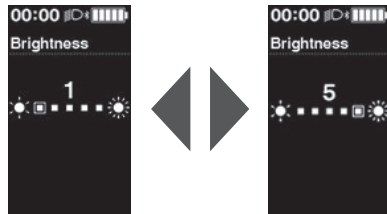

3. Press Assist-A or the function button to confirm the setting.
 - * The screen will automatically return to the setting menu screen.

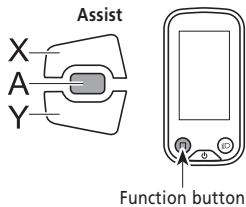

■ [Light] Light ON/OFF (SC-E7000 only)

Configure the battery-powered light setting.

1. Enter the [Light] menu.
 - (1) Launch the setting menu.
 - (2) Press Assist-X or Assist-Y to select [Light], then press Assist-A or the function button.
2. Press Assist-X or Assist-Y to select the required setting.

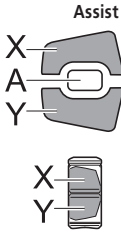

| Configurable items | Details |
|--------------------|-----------------------|
| [ON] | Keep light always on |
| [OFF] | Keep light always off |

3. Press Assist-A or the function button to confirm the setting.

* After confirmation, the screen will automatically return to the menu list screen.

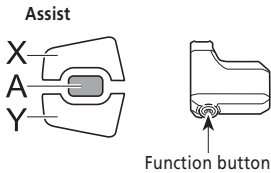

■ [Beep] Beep setting

Turn the beep sound ON/OFF.

Even when [Beep] is set to [OFF], a beep will sound when there is a misoperation, system error, etc.

1. Enter the [Beep] menu.
 - (1) Launch the setting menu.
 - (2) Press Assist-X or Assist-Y to select [Beep], then press Assist-A or the function button.
2. Press Assist-X or Assist-Y to move the cursor to the item you want to configure.

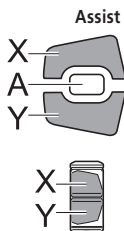

| Configurable items | Details |
|--------------------|---------------|
| [ON] | Enable beeps |
| [OFF] | Disable beeps |

< SC-E6100 >

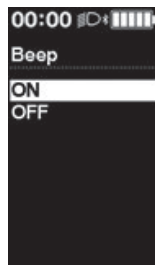

< SC-E7000 >



3. Press Assist-A or the function button to confirm the setting.

* The screen will automatically return to the setting menu screen.

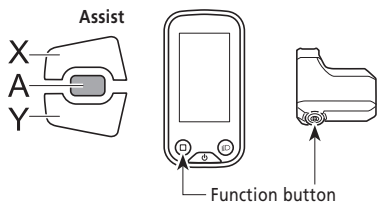

■ [Unit] Km/mile switching

Toggle between kilometers and miles.

1. Enter the [Unit] menu.
 - (1) Launch the setting menu.
 - (2) Press Assist-X or Assist-Y to select [Unit], then press Assist-A or the function button.
2. Press Assist-X or Assist-Y to move the cursor to the item you want to configure.

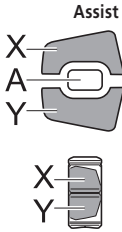

| Configurable items | Details |
|--------------------|--------------------|
| [km] | Displayed in km |
| [mile] | Displayed in miles |

3. Press Assist-A or the function button to confirm the setting.
 - * The screen will automatically return to the setting menu screen.

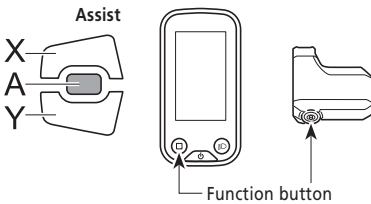

< SC-E6100 >



< SC-E7000 >



■ [Language] Language setting

Set the display language.

1. Enter the [Language] menu.
 - (1) Launch the setting menu.
 - (2) Press Assist-X or Assist-Y to select [Language], then press Assist-A or the function button.
2. Press Assist-X or Assist-Y to move the cursor to the item you want to configure.

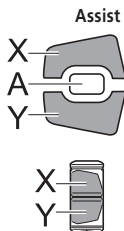

| Configurable items |
|--------------------|
| [English] |
| [Français] |
| [Deutsch] |
| [Nederlands] |
| [Italiano] |
| [Español] |

< SC-E6100 >



< SC-E7000 >



3. Press Assist-A or the function button to confirm the setting.
 - * The screen will automatically return to the setting menu screen.

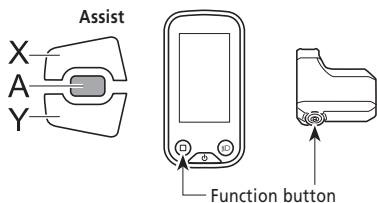

■ [Font color] Font color settings

Toggle the font character color between black and white.

1. Enter the [Font color] menu.
 - (1) Launch the setting menu.
 - (2) Press Assist-X or Assist-Y to select [Font color], then press Assist-A or the function button.
2. Press Assist-X or Assist-Y to move the cursor to the item you want to configure.

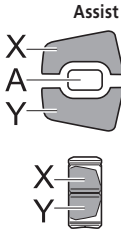

| Configurable items |
|--------------------|
| [White] |
| [Black] |

< SC-E6100 >

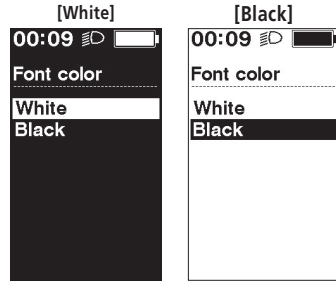

< SC-E7000 >

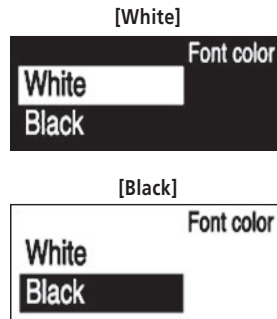

3. Press Assist-A or the function button to confirm the setting.

* The screen will automatically return to the setting menu screen.

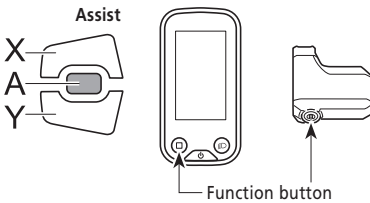

■ [Adjust] Gear shifting adjustment with the electronic gear shifting unit

If you need to adjust the rear shifting unit, contact the place of purchase.

■ [Shift timing] Automatic gear shifting timing setting

Adjust the shift timing of the automatic shift mode.

This setting is used when shifting advice is displayed during manual shift mode.

1. Enter the [Shift timing] menu.

- (1) Launch the setting menu.
- (2) Press Assist-X or Assist-Y to select [Shift timing], then press Assist-A or the function button.

2. Press Assist-X or Assist-Y to adjust the values.

- Pressing Assist-X to increase the value adjusts shift timing to make pedaling easier.
- Pressing Assist-Y to decrease the value adjusts shift timing to make pedaling harder.

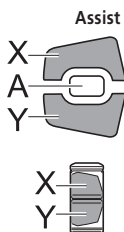

< SC-E6100 >

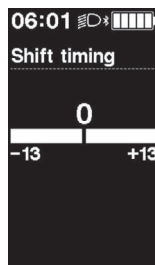

< SC-E7000 >



3. Press Assist-A or the function button to confirm the setting.

- * The screen will automatically return to the setting menu screen.

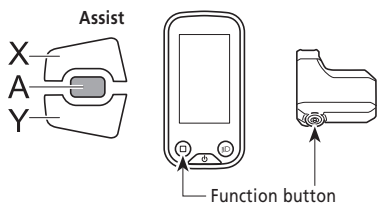

■ [Shifting advice] Shifting advice setting (SC-E6100 only)

Turn the shifting advice function ON/OFF.

If turned [ON], this notifies you of the recommended timing at which to shift based on the bicycle riding conditions during manual shifting mode.

1. Enter the [Shifting advice] menu.
 - (1) Launch the setting menu.
 - (2) Press Assist-X or Assist-Y to select [Shifting advice], then press Assist-A or the function button.
2. Press Assist-X or Assist-Y to move the cursor to the item you want to configure.

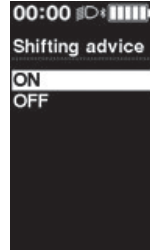
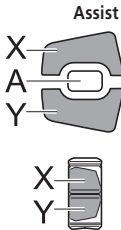

| Configurable items | Details |
|--------------------|--------------------------------------|
| [ON] | Enable the shifting advice function |
| [OFF] | Disable the shifting advice function |

3. Press Assist-A or the function button to confirm the setting.

* The screen will automatically return to the setting menu screen.

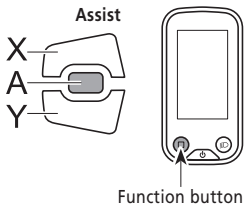

■ [RD protection reset] RD protection reset

In order to protect the system when the bicycle falls and is subjected to a strong impact, the RD Protection function will activate and momentarily sever the connection between the motor and the link, impairing the proper function of the rear derailleur. Executing RD Protection Reset restores the connection between the motor and the link, as well as the function of the rear derailleur.

1. Enter the [RD protection reset] menu.
 - (1) Launch the setting menu.
 - (2) Press Assist-X or Assist-Y to select [RD protection reset], then press Assist-A or the function button.
2. Press Assist-X or Assist-Y to select [OK].



| Configurable items | Details |
|--------------------|------------------------------------|
| [OK] | Execute the "RD protection reset." |
| [Cancel] | Cancel and return to setting menu. |

< SC-E6100 >

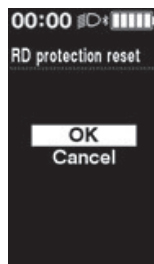

< SC-E7000 >



3. Press Assist-A or the function button.

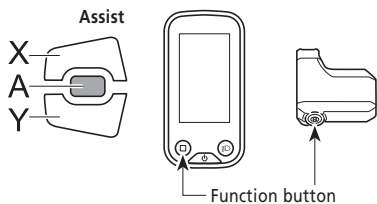

< SC-E6100 >



< SC-E7000 >



4. Rotate the crankarm.
Connection of motor and the link is restored.

■ [Display speed] Adjusting the display speed

Adjusts the displayed speed when there is a difference between the speed displayed on the cycle computer and other devices.

If the display on the cycle computer is adjusted, the actual speed may be higher than the displayed speed. Keep this in mind if riding in an area with a speed limit.

1. Enter the [Display speed] menu.

- (1) Launch the setting menu.
- (2) Press Assist-X or Assist-Y to select [Display speed], then press the function button.
If using SW-E6010, control is also possible with Assist-A.

2. Press Assist-X or Assist-Y to adjust the number.

- Press Assist-X to increase the number. The number displayed for the speed increases.
- Press Assist-Y to decrease the number. The number displayed for the speed decreases.

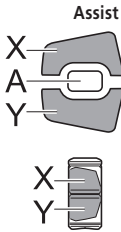

< SC-E6100 >

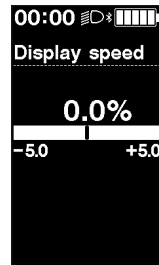

< SC-E7000 >

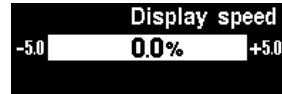

3. Press Assist-A or the function button to confirm the setting.

- * The screen will automatically return to the setting menu screen.

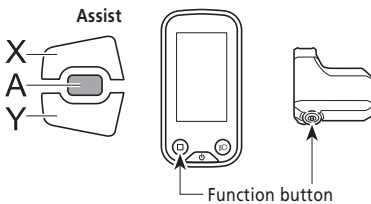

■ [Exit] Close setting menu screen

Return to the main screen.

1. Launch the setting menu.
2. Press Assist-X or Assist-Y to select [Exit], then press the function button.
If using SW-E6010, control is also possible with Assist-A.
* The screen will automatically return to the setting menu screen.

Settings (EW-EN100)

The setting function cannot be used while riding the bicycle.

■ RD protection reset

In order to protect the system when the bicycle falls and is subjected to a strong impact, the RD Protection function will activate and momentarily sever the connection between the motor and the link, impairing the proper function of the rear derailleur. Executing RD Protection Reset restores the connection between the motor and the link, as well as the function of the rear derailleur.

1. Hold the button down (for roughly eight seconds) until LED1 flashes red.
Once LED1 is flashing, release the button. When only LED1 is flashing red, the system is in the RD protection reset mode.
2. Rotate the crankarm.
Connection of motor and the link is restored.

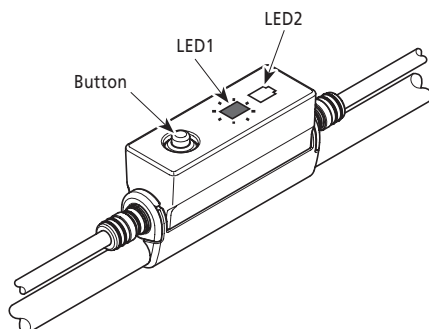

■ Adjust

You can adjust gear shifting only when using an electronic gear shifting unit.
If you need to adjust the derailleur, contact the place of purchase.

Connection and communication with devices

The system can be configured and firmware can be updated when the bicycle is connected to a device (PC/tablet).

You need E-TUBE PROJECT to configure SHIMANO STEPS and update firmware.

Download an E-TUBE PROJECT from the support website (<https://e-tubeproject.shimano.com>).

For information on how to install an E-TUBE PROJECT, check the support website.

- Connecting to devices is not possible while charging.
- You need SM-PCE1/SM-PCE02 and SM-JC40/SM-JC41 to connect SHIMANO STEPS to a PC.
- Firmware is subject to change without notice.

If necessary, contact the place of purchase.

About wireless functions

Functions

The latest functions can be checked by updating the software via E-TUBE PROJECT. For details, consult the place of purchase.

ANT connection

The wireless unit can send all information displayed on the basic screen of the cycle computer to an external device.

Bluetooth® LE connection

The wireless unit can send all information displayed on the basic screen of the cycle computer to an external device.

E-TUBE PROJECT for smartphones/tablets may be used if a Bluetooth LE connection is established using a smartphone/tablet.

E-TUBE RIDE can be used to check traveling data on a smartphone connected over Bluetooth® LE, even when using EW-EN100.

How to make a connection

To make a connection, the device connected to SC-E6100, SC-E7000 or EW-EN100 needs to be in connection mode. For information on how to switch the device to connection mode, refer to the manual for the device.

2.4 GHz digital wireless system

2.4 GHz-frequency digital wireless technology is the same technology used for wireless LAN communication.

However, on very rare occasions, the following and places may generate strong electromagnetic waves and interference, which may result in incorrect measurements.

- When near televisions, computers, radios and motors/engines, or when riding in car and trains.
- When near railroad crossings or railway tracks, and around television transmitting stations and radar bases.
- Around other wireless computers or digitally controlled light.





Specifications for wireless system

| Model no. | SC-E6100 | SC-E7000 | EW-EN100 |
|-------------------------------|-------------------|-------------------|-------------------|
| Frequency band | 2,402 - 2,480 MHz | 2,402 - 2,480 MHz | 2,402 - 2,480 MHz |
| Maximum radio-frequency power | +4 dBm | +4 dBm | +4 dBm |
| Firmware version | 4.0.0 | 4.0.0 | 4.0.0 |

■ Battery LED lamp error indications

System errors and similar warnings are indicated by the battery LED lamps through various lighting patterns.

If the situation does not improve, contact the place of purchase.

| Error indication type | Indication condition | Lighting pattern *1 | Recovery |
|-------------------------------|---|---|---|
| System error | Communication error with the bicycle system |  | Make sure that the cable is not loose or improperly connected. |
| Temperature protection | If the temperature exceeds the guaranteed operating range, the battery output is turned off. |  | Leave the battery in a cool place away from direct sunlight until the internal temperature of the battery decreases sufficiently. |
| Security authentication error | This is displayed if a genuine drive unit is not connected. This is displayed if any of the cables are disconnected. |  | Connect a genuine battery and drive unit. Check the condition of the cables. |
| Charging error | This is displayed if an error occurs during charging. |  | Remove the charger from the battery and press the power button, if an error appears contact an agency. |
| Battery malfunction | Electrical failure inside the battery |  | Use the battery power button to turn the power OFF, and then turn the power back ON. |

*1 ● : Not lit ○ : Lit up  : Blinking

■ Error messages on the cycle computer

Warnings

If the situation is resolved, this indication will disappear.
If the situation does not improve, consult a distributor.

< SC-E6100 >



< SC-E7000 >



| Code | Display preconditions | Operational restrictions while warning is displayed | Remedy |
|------|--|---|--|
| W011 | The traveling speed cannot be detected. | The maximum speed up to which power assistance is provided may decrease. (Power assistance is provided up to 25 km/h in top gear.) | Contact your place of purchase or a local bicycle dealer for assistance, since there is a chance of the following: <ul style="list-style-type: none"> • The speed sensor is installed in the wrong position. • The magnet included with the disc brake rotor has come off. |
| W013 | Initialization of torque sensor was not completed successfully. | Power assistance may be lower than usual. | With your foot off the pedal, press the battery power button and turn on the power again. |
| W020 | If the temperature exceeds the guaranteed operating range, the battery output is turned off. | No system functions will start. | If it has exceeded the temperature in which discharge is possible, leave the battery in a cool place away from direct sunlight until the internal temperature of the battery decreases sufficiently. If it is below the temperature in which discharge is possible, leave the battery indoors, etc. until its internal temperature is at a suitable temperature. |
| W032 | An electronic derailleur may have been installed in place of a mechanical derailleur. | Power assistance provided in [WALK] mode may be lower than usual. * The walk assist mode function may not be available in certain regions. | Reinstall the derailleur for which the system is configured to support. |

Error

If an error message is displayed on the entire screen, follow one of the procedures below to reset the display.

- Press the power button of the battery.
- Remove the battery from the battery mount.

NOTICE

If the situation does not improve even after turning the power back ON, consult with a distributor.

< SC-E6100 >



< SC-E7000 >



| Code | Display preconditions | Operational restriction when an error is being displayed | Remedy |
|------|--|--|--|
| E010 | A system error was detected. | Power assistance is not provided during riding. | Press the power button of the battery to turn it on again. |
| E013 | An anomaly was detected in the drive unit's firmware. | Power assistance is not provided during riding. | Contact the place of purchase or bicycle dealer. |
| E014 | The speed sensor may have been installed in the wrong position. | Power assistance is not provided during riding. | Contact the place of purchase or bicycle dealer. |
| E020 | A communication error between the battery and drive unit was detected. | Power assistance is not provided during riding. | Check that the cable between the drive unit and battery is properly connected. |
| E021 | Battery connected to drive unit conforms with system standards but is not supported. | Power assistance is not provided during riding. | Press the power button of the battery to turn it on again. |
| E022 | Battery connected to drive unit does not conform with system standards. | No system functions will start. | Press the power button of the battery to turn it on again. |
| E023 | Electrical failure inside the battery. | No system functions will start. | Use the battery power button to turn the power OFF, and then turn the power back ON. |
| E024 | Communication error with the bicycle system. | No system functions will start. | Make sure that the cable is not loose or improperly connected. |

| Code | Display preconditions | Operational restriction when an error is being displayed | Remedy |
|------|--|--|--|
| E025 | <p>This is displayed when a genuine drive unit is not connected.</p> <p>This is displayed if any of the cables are disconnected.</p> | No system functions will start. | Connect a genuine battery and drive unit. Check the condition of the cables. |
| E030 | The installed shifting component differs from the component configured in the system. | Power assistance is not provided during riding. | Contact your place of purchase or a local bicycle dealer for assistance. |
| E033 | The current firmware is not compatible with this system. | Power assistance is not provided during riding. | Connect to E-TUBE PROJECT, then update the firmware for all units to the latest version. |
| E043 | Part of the cycle computer's firmware may be damaged. | Power assistance is not provided during riding. | Contact the place of purchase or bicycle dealer. |

■ Error indications (EW-EN100)

When an error occurs, the two LEDs on EW-EN100 will quickly flash red at the same time.

If this occurs, follow one of the procedures below to reset the indication.

- Press the battery power switch to turn the power OFF.
- Remove the battery from the mount.

If the situation does not improve even after turning the power back ON, contact your place of purchase or the distributor.

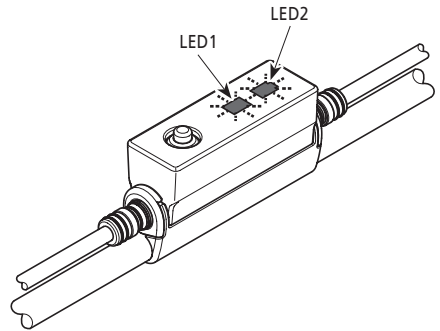

■ Troubleshooting

Assist function

| Symptom | Cause / Possibility | Remedy |
|---|---|---|
| Assistance is not being provided. | Is the battery sufficiently charged? | Check the battery charge. If the battery is nearly spent, recharge it. |
| | Are you riding on long slopes in summer weather or riding for a long time carrying a heavy load? The battery may be overheating. | Turn off the power, wait for a while and then check once more. |
| | The drive unit, cycle computer or assist switch may be connected incorrectly or there may be a problem with one or more of them. | Contact the place of purchase. |
| | Is the speed too high? | Check the Cycle Computer display. Assistance is not provided at speeds of 25 km/h or more. |
| Assistance is not being provided. | Are you pedaling? | The bicycle is not a motorbike, so you need to operate the pedals. |
| | Is the assist mode set to [OFF]? | Set the assist mode to [HIGH]. If you still do not feel that assistance is being given, contact the place of purchase. |
| | Is the system power ON? | If you have performed the steps below and still do not feel the assistance, contact the place of purchase. SC-E7000 Press the battery power button to turn the power ON. SC-E6100 Press the cycle computer power button or the battery power button to turn the power ON. |
| Assist traveling distance is too short. | The traveling distance may become shorter depending on road conditions, the gear position and whether the light are ON or OFF. | Check the battery charge. If the battery is nearly spent, recharge it. |
| | The battery characteristics will drop during winter weather. | This is not a sign of a problem. |
| | The battery is a consumable part. Repeated recharging and long periods of use will cause the battery to deteriorate (lose its performance). | If the distance that can be traveled on a single charge is very short, replace the battery with a new one. |

| Symptom | Cause / Possibility | Remedy |
|--------------------|---|---|
| Pedaling is stiff. | Are the tires inflated to a sufficient pressure? | Use a pump to add air. |
| | Is the assist mode set to [OFF]? | Set the assist mode to [HIGH]. If you still do not feel that assistance is being given, contact the place of purchase. |
| | The battery may be running low. | After charging the battery well, check the level of assistance again. If you still do not feel that assistance is being given, contact the place of purchase. |
| | Did you turn on the power with your foot placed on the pedal? | Turn on the power again without putting pressure on the pedal. If you still do not feel that assistance is being given, contact the place of purchase. |

Battery

| Symptom | Cause / Possibility | Remedy |
|--|---|---|
| All the five battery level indicators stay on. | The firmware version of the drive unit may be out-of-date. | Consult the place of purchase and check the firmware version. |
| The battery quickly loses its charge. | The battery may be at the end of its service life. | Replace the battery with a new one. |
| The battery cannot be recharged. | Is the power plug of the charger securely inserted into the electrical outlet? | Disconnect and then reconnect the power plug of the charger, and then repeat the recharging operation. If the battery still cannot be recharged, contact the place of purchase. |
| | Is the recharging plug of the charger securely inserted into the battery? | Disconnect and then reconnect the recharging plug of the charger, and then repeat the recharging operation. If the battery still cannot be recharged, contact the place of purchase. |
| | Is the charging adapter securely connected to the charging plug, or to the battery charging port? | Securely connect the charging adapter to the charging plug or to the battery charging port, and charge again. If the battery still does not charge, contact the place of purchase. |
| | Is the connecting terminal for the battery charger, charging adapter, or battery dirty? | Wipe the connection terminals with a dry cloth to clean them, and then repeat the recharging operation. If the battery still cannot be recharged, contact the place of purchase. |
| The battery does not start recharging when the charger is connected. | The battery may be at the end of its service life. | Replace the battery with a new one. |
| The battery and charger are becoming hot. | The temperature of the battery or charger may exceed the operating temperature range. | Stop recharging, wait for a while and then recharge again. If the battery is too hot to touch, it may indicate a problem with the battery. Contact the place of purchase. |

| Symptom | Cause / Possibility | Remedy |
|---|--|--|
| The charger is warm. | If the charger is being used continuously to charge batteries, it may become warm. | Wait a while before using the charger again. |
| The LED on the charger does not illuminate. | Is the recharging plug of the charger securely inserted into the battery? | Check the connection for any foreign objects before reinserting the charging connector. If there is no change, contact the place of purchase. |
| | Is the battery fully charged? | If the battery is fully charged, the LED on the battery charger turns off, but this is not a malfunction. Disconnect and then reconnect the power plug of the charger, and then repeat the recharging operation. If the LED on the charger still does not illuminate, contact the place of purchase. |
| The battery cannot be removed. | | Contact the place of purchase. |
| The battery cannot be inserted. | | Contact the place of purchase. |
| Fluid is coming out from the battery. | | Contact the place of purchase. |
| An abnormal odor can be detected. | | Stop using the battery immediately and contact the place of purchase. |
| Smoke is coming out from the battery. | | Stop using the battery immediately and contact the place of purchase. |
| The replaced battery does not work. | The firmware of the drive unit may not be compatible with the battery. | Contact the place of purchase to inquire about compatibility. |

Lights

| Symptom | Cause / Possibility | Remedy |
|--|---|--------------------------------|
| The front light or the tail light does not illuminate even when the switch is pressed. | The E-TUBE PROJECT settings may be wrong. | Contact the place of purchase. |

Cycle computer

| Symptom | Cause / Possibility | Remedy |
|--|--|--|
| The cycle computer is not displayed when you push the battery power button. | The amount of battery charge may be insufficient. | Recharge the battery, and then turn the power on once more. |
| | Is the power turned on? | Hold down the power button to turn on the power. |
| | Is the battery charging? | The power cannot be turned on while the battery is mounted on the bicycle and being charged. Stop charging. |
| | Is the cycle computer correctly installed to the bracket? | Install the cycle computer correctly while referring to "Installing and removing the cycle computer." |
| | Is the electric wire connector correctly installed? | Check to see if the connector of the electric wire connecting the motor unit to drive unit is not disconnected. If you are not sure, contact the place of purchase. |
| | A component that the system cannot identify may be connected. | Contact the place of purchase. |
| < SC-E6100 > The system does not start up when you press the cycle computer power button. | Did you use the cycle computer in, or expose it to, low temperatures for an extended period? | The cycle computer may become unable to turn on if used in, or exposed to, low temperatures for an extended period. Turn it on by pressing the power button on the battery. If it still does not turn on, contact the place of purchase. |
| | Is the cycle computer correctly installed to the bracket? | Install the cycle computer correctly while referring to "Installing and removing the cycle computer." |
| The gear position is not displayed. | The gear position is only displayed when the electronic gear shifting unit is installed. | Check if the electric wire connector is disconnected. If you are not sure, contact the place of purchase. |
| Can the beep be turned off. | | Change the setting. Refer to "[Beep] Beep setting." |
| < SC-E6100 > Can the backlight be turned off. | | Change the setting. Refer to "[Backlight] Backlight setting (SC-E6100 only)." |
| The setting menu cannot be launched while riding the bicycle. | The product is designed so that if it detects that the bicycle is being ridden, the Setting menu cannot be launched. This is not a sign of an abnormality. | Stop the bicycle and then make the settings. |

Other

| Symptom | Cause / Possibility | Remedy |
|--|---|---|
| When pressing the switch, two beeps sound, and the switch cannot be operated. | Operation of the switch being pressed has been disabled. | It is not a sign of a malfunction. |
| Three beeps sound. | An error or warning is occurring. | This occurs when a warning or error is displayed on the cycle computer. Refer to the section "Error messages on the cycle computer" and follow the instructions provided for the appropriate code. |
| When using an electronic gear shifting mode, I feel that the level of assistance weakens when the gears shift. | This occurs because the level of assistance is being adjusted to the optimum level by the computer control. | It is not a sign of a malfunction. |
| Sound occurs after gear shifting. | | Contact the place of purchase. |
| A noise can be heard from the rear wheel during normal riding. | Gear shifting adjustment may not have been carried out correctly. | For mechanical gear shifting Adjust the cable tension. For details, refer to the Service Instructions for the derailleur. For powered gear shifting Contact the place of purchase. |
| When you stop the bicycle, the gear does not shift to the position preset in the start mode. | You may have been pressing the pedals too strongly. | If you press the pedals lightly, the gear shifts more easily. |

*** Key number**

The number that is attached to the key is needed in case you need to purchase spare keys.
Make a note of the number in the following box and keep it in a safe place.

| Key number |
|------------|
| |

SHIMANO

SHIMANO NORTH AMERICA BICYCLE, INC.

One Holland, Irvine, California 92618, U.S.A. Phone: +1-949-951-5003

SHIMANO EUROPE B.V.

High Tech Campus 92, 5656 AG Eindhoven, The Netherlands Phone: +31-402-612222

SHIMANO INC.

3-77 Oimatsu-cho, Sakai-ku, Sakai City, Osaka 590-8577, Japan

Please note: specifications are subject to change for improvement without notice. (English)

© Nov. 2019 by SHIMANO INC. ITP