

---

**Wichtig:**  
Vor Gebrauch sorgfältig durchlesen/  
Montageanleitung für  
späteres Nachlesen  
aufbewahren

**Important:**  
Lisez attentivement/  
conserver les instruc-  
tions d'installation  
pour référence future  
avant utilisation

**Importante:**  
lettura/conservare  
Istruzioni per l'installa-  
zione per riferimento  
futuro accuratamente  
prima dell'uso

**Important:**  
Read carefully before  
assembling/keep and  
store instruction for  
reference

# MUSK

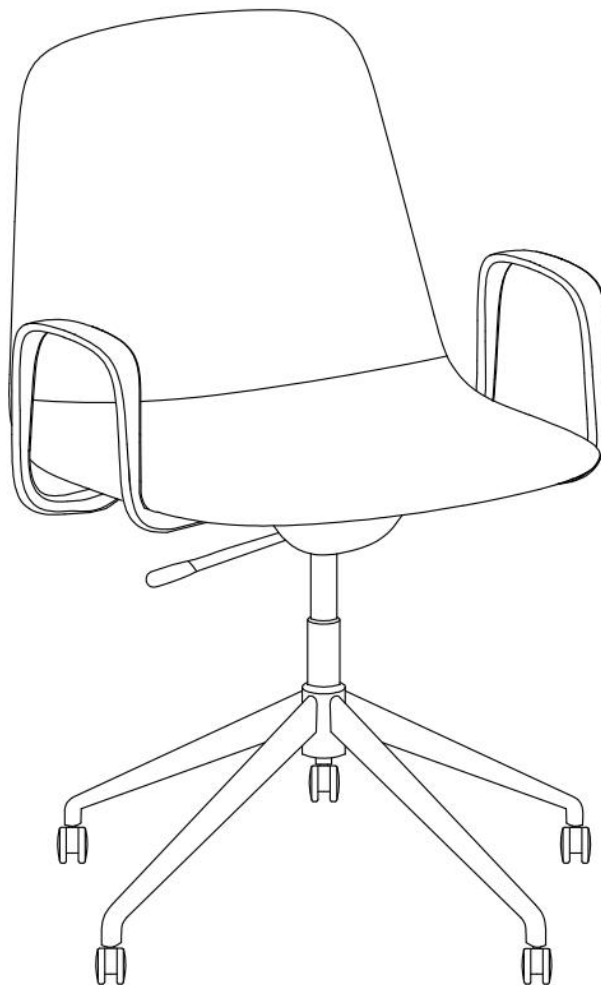



## Warnhinweise

### Bestimmungsgemässer Gebrauch:

Bitte achten Sie darauf, dass Ihre Möbel nur Ihrem Zweck gemäss verwendet werden. Für eine dauerhafte Funktionsfähigkeit ist eine sachgerechte Nutzung und regelmässige Unterhaltspflege sehr wichtig.

## Mises en garde

### Utilisation conforme:

Veillez vous assurer que vos meubles sont utilisés uniquement pour leur usage prévu. Un entretien régulier et une utilisation conforme sont essentiels pour assurer un fonctionnement durable.

## Avvertenze

### Utilizzo per lo scopo previsto:

assicuratevi che i vostri mobili siano utilizzati solo per lo scopo per cui sono stati realizzati. Per garantire il loro funzionamento nel tempo è importante utilizzarli correttamente e sottoporli regolarmente a cure manutentive.

## Warning notice

### Intended use:

Please make sure that you only use your furniture for the purpose it was designed for. Correct use and regular maintenance are essential for ensuring your furniture remains in working order for the long-term.

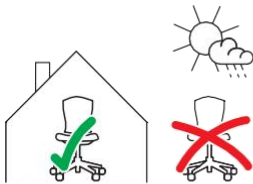

### Anwendung:

Der von Ihnen erworbene Bürostuhl eignet sich für die Benutzung durch eine Person im Bürobereich. Er ist nicht für den Nass-, Aussen- oder gewerblichen Bereich geeignet.

### Usage:

La chaise de bureau que vous avez achetée convient pour une utilisation par une personne dans un bureau. Elle ne convient pas pour l'extérieur, les milieux humides ou le domaine commercial.

### Impiego:

la sedia da ufficio acquistata è adatta per essere utilizzata da una persona in ufficio. Non è adatta per gli esterni, per l'esposizione alla pioggia o per ambienti commerciali.

### Area of use:

The office chair you have purchased is suitable for use in an office environment. It is not suitable for areas that are wet, outside or used for commercial purposes.



### Benutzung:

Das Sitzen auf Arm-, Rückenlehnen ist nicht gestattet. Das Stehen auf Sitzmöbeln ist nicht gestattet, es ist kein Ersatz für Tritte oder Leitern.

### Utilisation:

Il n'est pas permis de s'asseoir sur les accoudoirs ou le dossier. Il n'est pas permis de grimper sur des sièges, ce ne sont pas des substituts aux escaliers ou échelles.

### Utilizzo:

non è consentito sedersi sui braccioli o sullo schienale. Non è consentito stare in piedi sulla seduta, non sostituisce un gradino o una scala.

### Use:

You must not sit on the armrests or the backrest. Standing on the seat is not permitted, the chair is not a substitute for steps or ladders.



### ACHTUNG

**Explosionsgefahr:** Die Gasdruckfeder für die Sitzhöhenverstellung steht unter sehr hohem Druck. Daher diese nicht manipulieren, reparieren oder öffnen. Wenden Sie sich bei Störungen an den Migros-Service oder eine Fachperson.

### ATTENTION

**Risque d'explosion:** Les ressorts à gaz pour le réglage en hauteur du siège sont sous très haute pression. C'est pourquoi, il ne faut pas les manipuler, réparer ou ouvrir. En cas de problème, adressez-vous à Migros-Service ou à un spécialiste.

### ATTENZIONE

**Pericolo di esplosione:** la molla a gas a compressione per la regolazione dell'altezza di seduta è sottoposta a una pressione molto elevata, pertanto è vietato manipolarla, ripararla o aprirla. In caso di guasto rivolgersi al servizio di assistenza Migros o a un esperto.

### CAUTION

**Risk of explosion:** The gas pressure spring for adjusting the height of the seat is under very high pressure. You must not tamper with it or try to repair or open it. Contact Migros-Service or a specialist if there is a fault.



**Max. Belastung:**  
110 kg.

**Charge max.:**  
110 kg.

**Carico max.:**  
110 kg.

**Max. load:**  
110 kg.

**Warnhinweise****Mises en garde****Avvertenze****Warning notice**

**ACHTUNG**  
**Verschluck- und Erstickungsgefahr:**  
Kleinteile und Verpackungsmaterial können verschluckt werden.

**ATTENTION**  
**Risque d'ingestion et d'étouffement:**  
Les petites pièces et le matériel d'emballage peuvent être avalés.

**ATTENZIONE**  
**Pericolo di ingestione e soffocamento:**  
piccole parti e materiale di imballaggio possono essere ingerite.

**CAUTION**  
**Risk of swallowing and choking:**  
Small parts and packaging material may be swallowed.



Tüten und Folien sind kein Spielzeug! Bitte von Babys und Kleinkindern fernhalten! Nicht über den Kopf ziehen, Erstickungsgefahr!

Les sacs et films ne sont pas des jouets! Veuillez les tenir hors de portée des bébés et jeunes enfants! Ne pas mettre sur la tête, risque d'étouffement!

Sacchetti e pellicole non sono un giocattolo! Tenere lontano dalla portata dei neonati e dei bambini piccoli! Non metterli in testa, pericolo di soffocamento!

Bags and film coverings are not toys! Please keep away from babies and small children! Do not put them over your head, risk of suffocation!



**ACHTUNG, Verletzungsgefahr:**  
Kleinkinder dürfen sich nicht im Montage-Bereich aufhalten und an Möbeln hochziehen oder hinaufklettern.

**ATTENTION, risque de blessures:**  
Les jeunes enfants ne peuvent pas se tenir dans la zone de montage ni tirer ou grimper sur des meubles.

**ATTENZIONE, pericolo di lesioni:**  
tenere i bambini lontano dal luogo di montaggio e evitare che si appendano o arrampichino sul mobile.

**CAUTION, risk of injury:**  
Small children must keep away from the assembly area. They must refrain from climbing up on the furniture.





**Altersfreigabe:**  
Nicht für Kinder unter drei Jahren geeignet.

**Age minimum:**  
Ne convient pour les enfants de moins de trois ans.

**Limite di età:**  
non adatto per bambini sotto i tre anni.

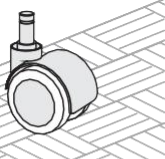
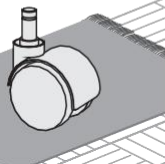
**Age restriction:**  
Not suitable for children under three.

1.	Allgemeine Hinweise	Remarques générales	Avvertenze generali	General information
	<p><b>ACHTUNG</b>  <b>Direkte Sonneneinstrahlung:</b>          Führt zu Farbveränderungen.</p>	<p><b>ATTENTION</b>  <b>Exposition directe au soleil:</b>          Provoque des décolorations.</p>	<p><b>ATTENZIONE</b>  <b>Irraggiamento diretto del sole:</b>          ne modifica il colore.</p>	<p><b>ATTENTION</b>  <b>Direct sunlight:</b>          results in discolouration.</p>
<p>1.</p>  <p>2.</p> 	<p><b>Rollentypen:</b>          Ab Werk werden Hartbodenrollen geliefert. Für Teppiche ist optional ein «Rollenset 11 mm» erhältlich unter</p>	<p><b>Types de roulettes:</b>          Livré standard avec des roulettes pour sols durs. Pour les tapis, un «kit de roulettes de 11 mm» est disponible en option sur</p>	<p><b>Tipi di rotelle:</b>          la fabbrica fornisce rotelle per il pavimento duro. Per i tappeti è disponibile un «set di rotelle 11 mm» ordinabile su</p>	<p><b>Types of casters:</b>          Casters for hard floors are supplied from the factory. An «11 mm caster set» is available optionally for carpets at</p>
	<p><b>Leder/Stoff:</b>          Schützen Sie das Leder/den Stoff vor scharfen Gegenständen (Schlüssel, Gurtschnallen, etc.).</p>	<p><b>Cuir/tissu:</b>          Protégez le cuir/tissu des objets coupants (clés, boucles de ceinture etc.).</p>	<p><b>Pelle/tessuto:</b>          proteggere la pelle/il tessuto da oggetti taglienti (chiavi, fibbie, ecc.).</p>	<p><b>Leather/fabric:</b>          Protect the leather/fabric against sharp objects (e.g. keys, belt buckles, etc.).</p>

---

1.

**Allgemeine  
Hinweise**

**Remarques  
générales**

**Avvertenze  
generali**

**General  
information**

**ACHTUNG Jeans:**  
Jeans-Produkte können auf hellen Überzügen zu Verfärbungen führen.

**ATTENTION jeans:**  
les tissus en jean peuvent altérer la couleur des revêtements clairs.

**ATTENZIONE jeans:**  
sui rivestimenti chiari il tessuto jeans può causare un'alterazione del colore.

**CAUTION Jeans:**  
Jeans products can discolour light cover fabrics.

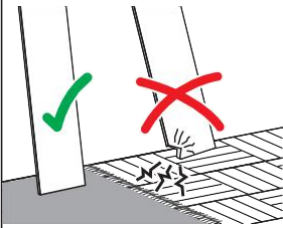
**Montageschäden:**

Vermeiden Sie, indem Sie einen sauberen und weichen Untergrund verwenden (z.B. Teppich). Teile beim Auspacken oder während der Montage nur auf weiche Unterlagen legen/stellen. Darauf achten, dass grössere Teile nicht kippen können.

**Dommages au montage:**

Évitez les dommages en utilisant un fond propre et doux (p.ex. tapis). Lors du déballage et montage, posez/placez les éléments uniquement sur un fond doux. Assurez-vous que les grands éléments ne peuvent pas basculer.

**Danni in fase di montaggio:**

evitare di causare danni utilizzando una base pulita e morbida (ad es. tappeto). Nella fase di disimballaggio e durante il montaggio, appoggiare i pezzi esclusivamente su una base morbida. Fare attenzione che i pezzi più grandi non si ribaltino.

**Damages during assembly:**

These can be avoided if you use a clean soft surface (e.g. carpet). Only place parts on a soft surface when unpacking or during the assembly. Make sure that larger parts cannot tip over.

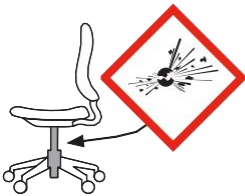
**ACHTUNG, Explosionsgefahr:**

Die Gasdruckfeder für die Sitzhöhenverstellung steht unter sehr hohem Druck. Daher diese nicht manipulieren, reparieren oder öffnen. Wenden Sie sich bei Störungen an den Migros-Service oder eine Fachperson.

**ATTENTION, risque d'explosion:**

Les ressorts à gaz pour le réglage en hauteur du siège sont sous très haute pression. C'est pourquoi, il ne faut pas les manipuler, réparer ou ouvrir. En cas de problème, adressez-vous à Migros-Service ou à un spécialiste.

**ATTENZIONE, pericolo di esplosione:**

la molla a gas a compressione per la regolazione dell'altezza di seduta è sottoposta a una pressione molto elevata, pertanto è vietato manipolarla, ripararla o aprirla. In caso di guasto rivolgersi al servizio di assistenza Migros o a un esperto.

**CAUTION, Risk of explosion:**

The gas pressure spring for adjusting the height of the seat is under very high pressure. You must not tamper with it or try to repair or open it. Contact Migros-Service or a specialist if there is a fault.

**Personen:**

Für die Montage erforderliche Anzahl Personen.

**Personnes:**

Nombre de personnes nécessaires au montage.

**Persone:**

numero di persone necessarie per il montaggio.

**People:**

Number of people required for the assembly.

**Montagerichtzeit:**

Ungefähre Zeit in Stunden.

**Durée indicative du montage:**

Durée approximative en heures.

**Tempo di montaggio:**

tempo in ore approssimativo.

**Assembly time:**

Approximate time in hours.

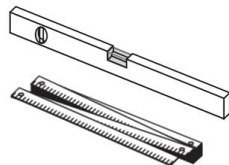
**Benötigtes Werkzeug:****Outils nécessaires:****Attrezzi necessari:****Tools required:**

2.

Montage-  
hinweise

Instructions de  
montage

Istruzioni di  
montaggio

Assembly  
information

Bau-/Kleinteile:

Éléments/pièces:

Componenti/  
piccoli pezzi:

Components/  
small parts:

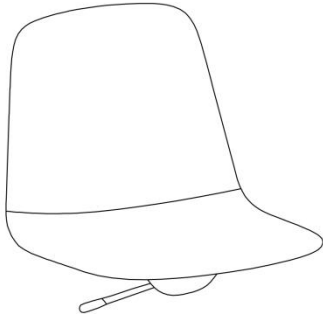

1

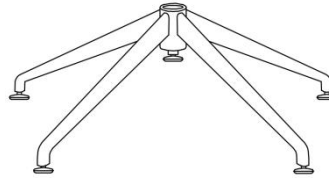

2



3

**Optional**

Bau-/Kleinteile:

Éléments/pièces:

Componenti/  
piccoli pezzi:

Components/  
small parts:

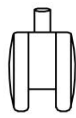

X5

4

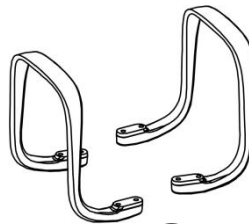

5



x8  
M6\*25

A

3.

Montage-  
anleitung

Instructions de  
montage

Istruzioni per  
il montaggio

Assembling  
instruction

1

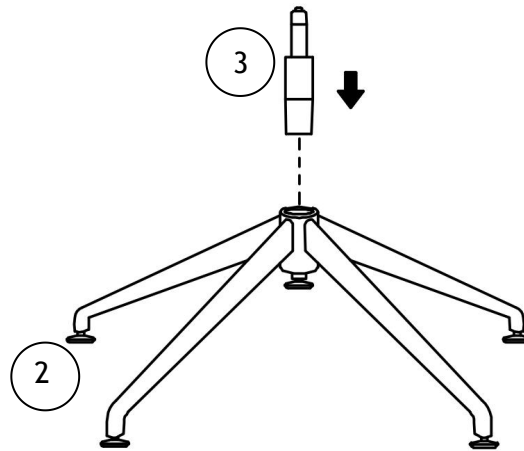

2

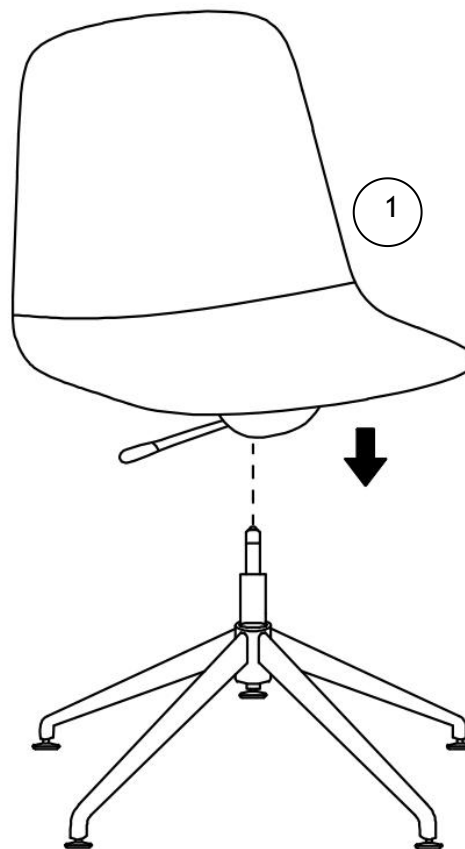



Option A

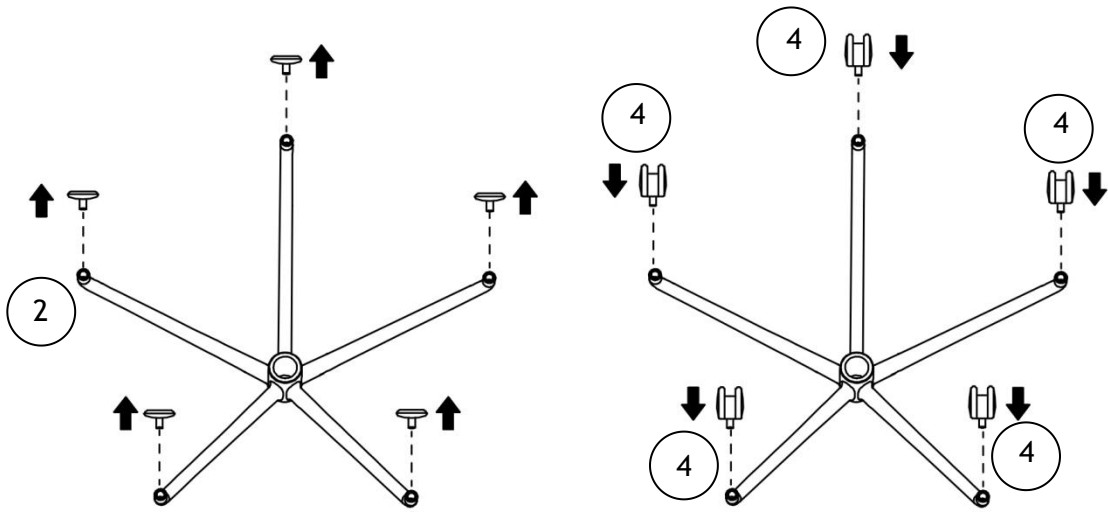

Option B

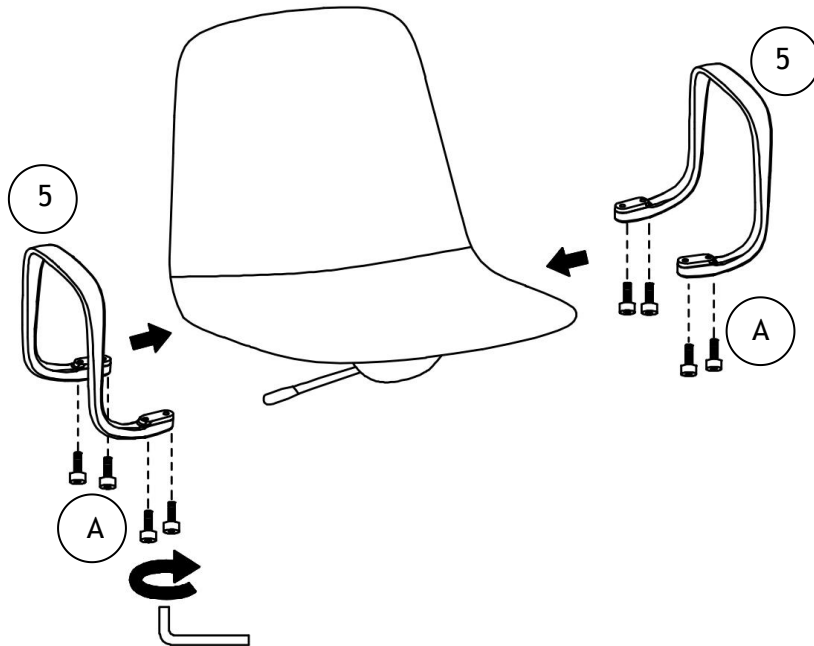

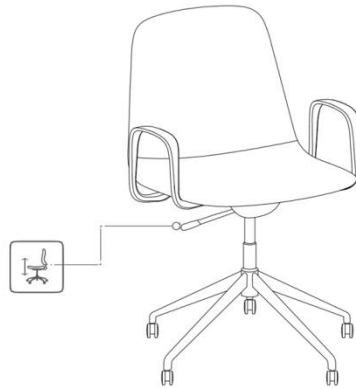

**Sitzfläche.**  
Sitzhöhe einstellen

**Assise.**  
Régler la hauteur d'as-  
sise

**Sedile.**  
Regolazione dell'al-  
tezza

**Seat area.**  
Adjust seat height

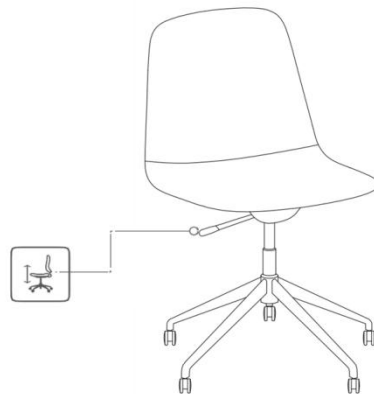

**Sitzfläche.**  
Sitzhöhe einstellen

**Assise.**  
Régler la hauteur d'as-  
sise

**Sedile.**  
Regolazione dell'al-  
tezza

**Seat area.**  
Adjust seat height

**Reinigung allgemein:**

Flecken immer sofort entfernen. Ein sauberes, weisses Tuch verwenden.



Sauberes Wasser verwenden. Lässt sich der Fleck so nicht entfernen, seifenhaltiges Wasser verwenden. Werden Reinigungsmittel verwendet, diese immer zuerst an einer nicht sichtbaren Stelle testen.



Keine chemischen, scheuernden oder kratzenden Reinigungs-/Hilfsmittel verwenden.

**Nettoyage en général:**

Toujours éliminer immédiatement les taches. Utiliser un chiffon blanc, propre.

Utiliser une eau propre. Si la tache ne s'enlève pas, utiliser une eau savonneuse. Si un produit de nettoyage est utilisé, toujours l'essayer préalablement dans un endroit invisible.

Ne pas utiliser de produits ou moyens chimiques, agressifs ou abrasifs.

**Pulizia generale:**

rimuovere sempre subito le macchie. Utilizzare un panno bianco, pulito.

Utilizzare acqua pulita. Se la macchia non viene via, utilizzare dell'acqua con sapone. Se si utilizzano dei detergenti, provarli sempre prima in un punto non visibile.

Non utilizzare detergenti chimici o prodotti/materiali abrasivi.

**General cleaning instructions:**

Always remove stains immediately. Use a clean, white cloth.

Use clean water. If the stain does not come out, use soapy water. If you use cleaning detergents, always test them first in a concealed spot.

Do not use any chemical or abrasive cleaning detergents or cloths/tools.

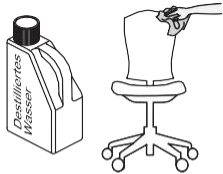
**Leder/Stoff:**

Flecken immer sofort mit destilliertem Wasser entfernen. Ein sauberes, weisses Tuch verwenden.



Oberflächen regelmässig absaugen, damit durch Schmutz keine Abnutzungserscheinungen oder Schäden entstehen.

**Cuir/tissu:**

Toujours éliminer immédiatement les taches avec de l'eau distillée. Utiliser un chiffon blanc, propre.

Aspirer régulièrement les surfaces afin d'éviter l'usure ou les dommages par la saleté.

**Pelle/tessuto:**

rimuovere sempre subito le macchie utilizzando acqua distillata. Utilizzare un panno bianco, pulito.

Aspirare regolarmente in modo che lo sporco non logori o danneggi le superfici.

**Leather/fabric:**

Always remove stains immediately with distilled water. Use a clean, white cloth.

Vacuum surfaces on a regular basis so the dirt does not cause any signs of wear or damage.

**Schrauben:**

Für einwandfreie, zuverlässige Funktion, Schrauben regelmäßig nachziehen (z.B. vierteljährlich).

**Vis:**

Resserrer régulièrement les vis (p.ex. tous les 3 mois) pour assurer un fonctionnement sûr et correct.

**Viti:**

per garantire un funzionamento corretto e sicuro tirare regolarmente le viti (ad es. ogni tre mesi).

**Screws:**

To keep your furniture in good working order, tighten the screws regularly (e.g. every three months).

7.	Entsorgung	Élimination	Smaltimento	Disposal
----	------------	-------------	-------------	----------

	<p><b>Entsorgungsservice:</b></p> <p>Micasa bietet Ihnen einen Entsorgungsservice an. Weitere Informationen erhalten Sie unter <a href="http://www.micasa.ch">www.micasa.ch</a></p>	<p><b>Service d'élimination:</b></p> <p>Micasa vous propose un service d'élimination. Vous trouverez des informations supplémentaires sur <a href="http://www.micasa.ch">www.micasa.ch</a></p>	<p><b>Servizio di smaltimento:</b></p> <p>Micasa vi offre un servizio di smaltimento. Ulteriori informazioni sono disponibili su <a href="http://www.micasa.ch">www.micasa.ch</a></p>	<p><b>Disposal service:</b></p> <p>Micasa offers a disposal service. For more information visit <a href="http://www.micasa.ch">www.micasa.ch</a></p>
	<p><b>Entsorgung:</b> Nicht mehr verwendete Möbel der fachgerechten Entsorgung übergeben. Wenden Sie sich an Ihre lokale Entsorgungsstelle.</p>	<p><b>Élimination:</b> Veuillez remettre les meubles qui ne sont plus utilisés à une entreprise d'élimination. Adressez-vous à votre centre de collecte local.</p>	<p><b>Smaltimento:</b> i mobili dismessi devono essere conferiti presso i centri di raccolta rifiuti per il loro corretto smaltimento. Rivolgersi presso il centro di raccolta locale.</p>	<p><b>Disposal:</b> To correctly dispose of furniture that is no longer used, contact your local recycling centre.</p>

8.	Kontakt / Service	Contact / service	Contatto / servizio	Contact / service
----	-------------------	-------------------	---------------------	-------------------

	<p><b>Fragen / Anregungen:</b> Wir sind gerne für Sie erreichbar: Montag bis Freitag 08.00 bis 18.00 Uhr Samstag 08.30 bis 16.30 Uhr Tel. 0800 840 848</p>	<p><b>Questions / suggestions:</b> Nous sommes à votre disposition: Lundi - vendredi 08h00 à 18h00 Samedi 08h30 à 16h30 Tél. 0800 840 848</p>	<p><b>Domande / suggerimenti:</b> siamo a vostra disposizione: lunedì - venerdì dalle 08.00 alle 18.00 sabato dalle 08.30 alle 16.30 Tel. 0800 840 848</p>	<p><b>Questions / Suggestions</b> Please contact us. Our opening times are: Monday - Friday 8.00 to 18.00 Saturday 8.30 to 16.30 Phone 0800 840 848</p>
---	--	---	--	---

	<p><b>Ersatzteile:</b> Erhalten Sie direkt im Online-Shop von Migros-Service: <a href="http://www.migros-service.ch">www.migros-service.ch</a></p>	<p><b>Pièces de rechange:</b> Vous les obtenez directement dans le magasin en ligne de Migros-Service: <a href="http://www.migros-service.ch">www.migros-service.ch</a></p>	<p><b>Pezzi di ricambio:</b> sono disponibili direttamente sull'online-shop di Migros-Service: <a href="http://www.migros-service.ch">www.migros-service.ch</a></p>	<p><b>Spare parts:</b> Available directly from the Migros-Service online shop: <a href="http://www.migros-service.ch">www.migros-service.ch</a></p>
---	--	---	---	---



