

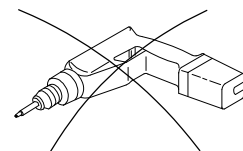

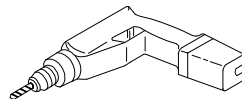

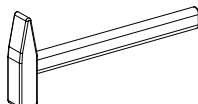

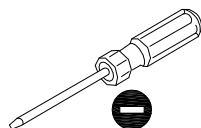

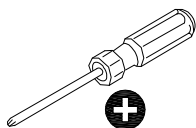
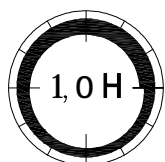
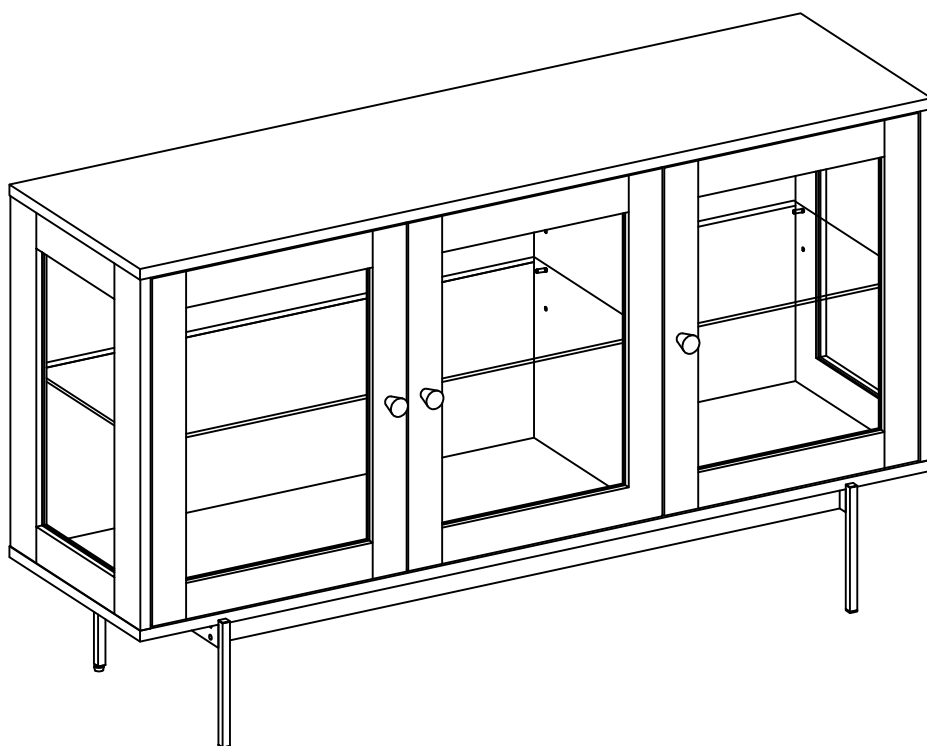
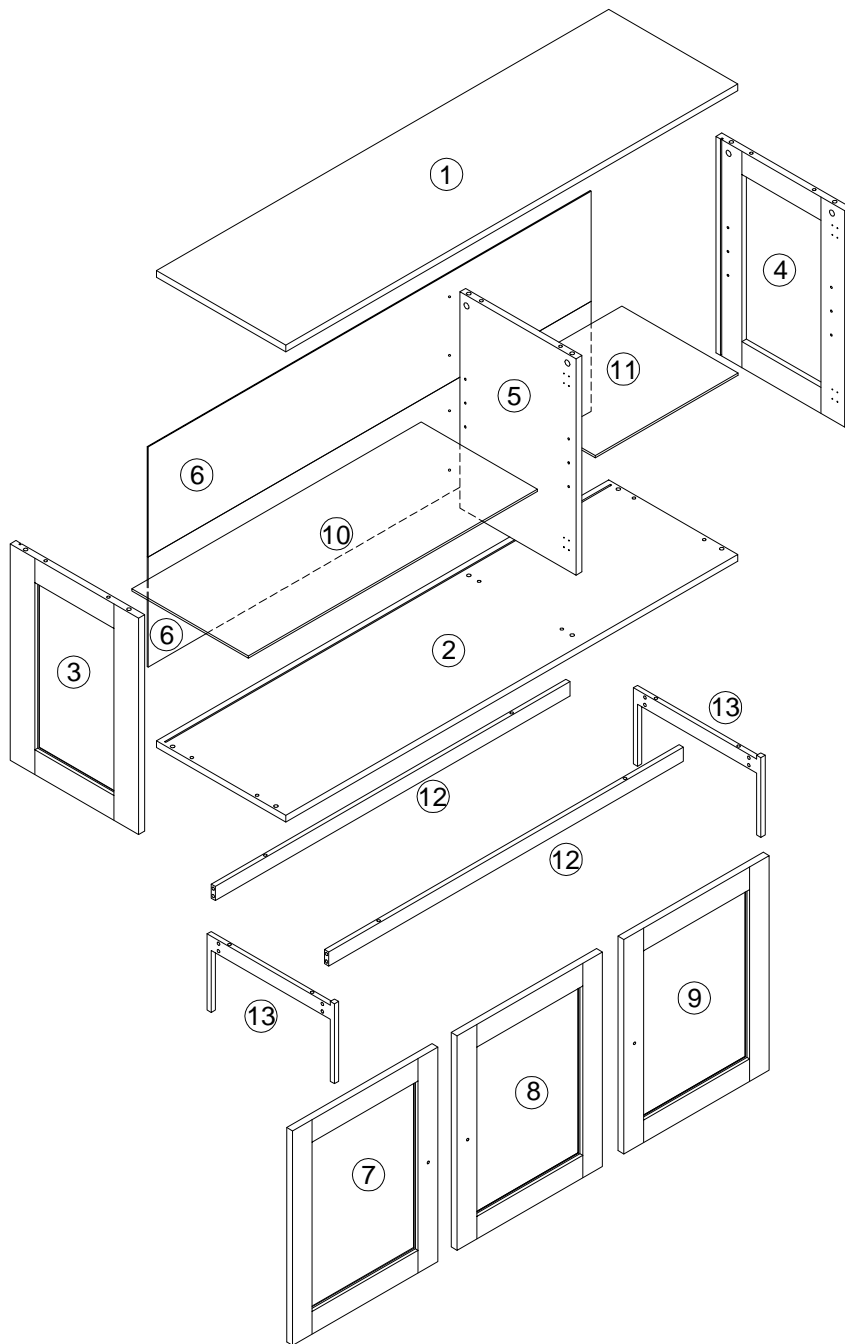











# Angus







08/01/2021

			✓			
①	1	1400x400x18		⑧	1	575x450x18
②	1	1400x400x18		⑨	1	575x450x18
③	1	580x399x18		⑩	1	895x360x6
④	1	580x399x18		⑪	1	442x360x6
⑤	1	580x360x18		⑫	2	1097x38x13
⑥	2	1371x295x2.75		⑬	2	395x210x13
⑦	1	575x450x18				





<p>A x 6</p>  <p>6.3×45mm</p>	<p>B x 6</p>  <p>Ø15×12mm</p>	<p>C x 12</p>  <p>Ø8×30mm</p>	<p>D x 4</p>  <p>Ø18</p>	<p>E x 2</p>  <p>L=100mm</p>
<p>F x 45</p>  <p>3.5×14mm</p>	<p>G x 3</p>  <p>4×22mm</p>	<p>H x 3</p>  <p>Ø20×20mm</p>	<p>J x 6</p>  <p>7×48mm</p>	<p>K x 8</p>  <p>M6×30mm</p>
<p>L x 8</p>  <p>M6×48mm</p>	<p>M x 4</p>  <p>3.5×20mm</p>	<p>N x 8</p>  <p>Ø5×20mm</p>	<p>P x 4</p>  <p>FK17</p>	<p>Q x 2</p>  <p>FK9</p>
<p>R x 6</p>  <p>9×9×14mm</p>	<p>S x 2</p>  <p>Ø13mm</p>	<p>T x 6</p>  <p>Ø20mm</p>	<p>U x 1</p>  <p>4mm</p>	<p>V x 1</p>  <p>10×10×30mm</p>

# 1

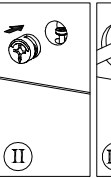
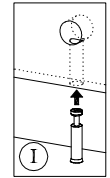
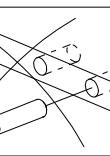
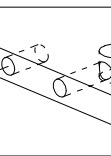
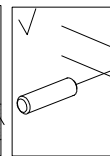
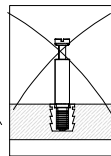
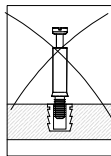
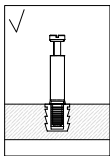
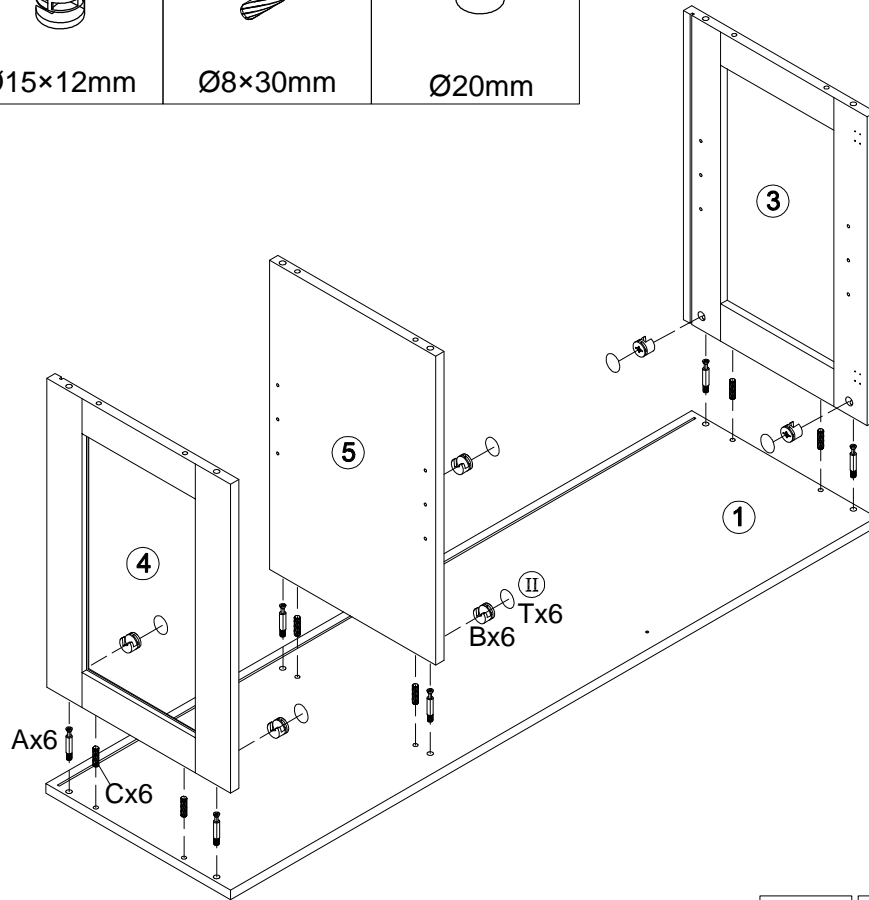
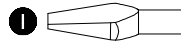
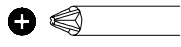
<b>A x 6</b>  6.3x45mm	<b>B x 6</b>  Ø15x12mm	<b>C x 6</b>  Ø8x30mm	<b>T x 6</b>  Ø20mm
---	---	--	--



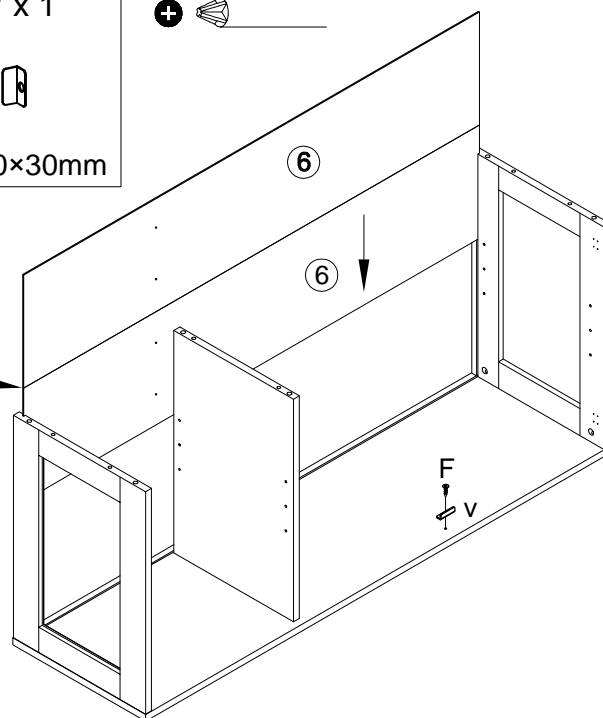
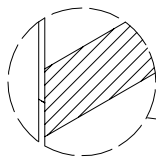
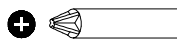

# 2

<b>F x 1</b>  3.5x14mm	<b>V x 1</b>  10x10x30mm
---	---



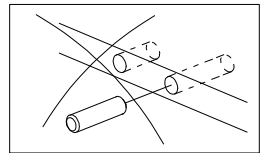
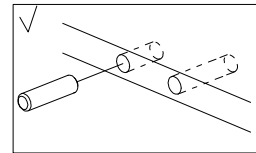
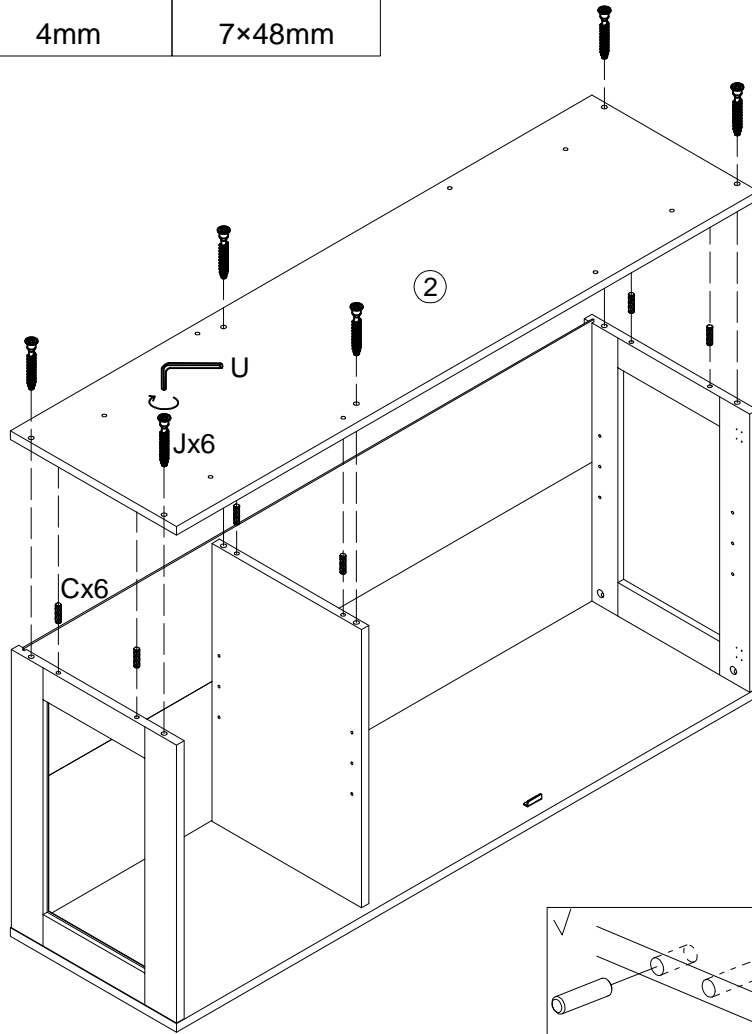
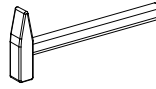

# 3

C x 6  Ø8×30mm	U x 1  4mm	J x 6  7×48mm
---	---	--



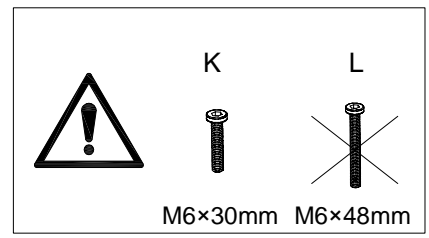
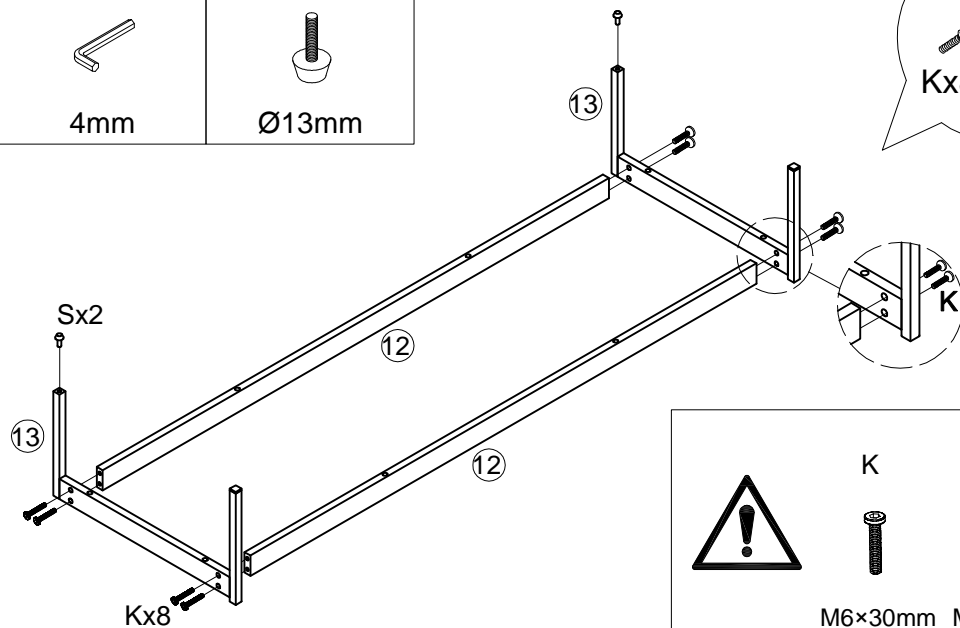
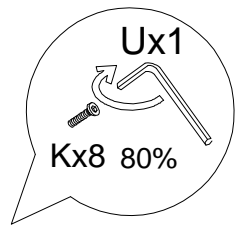

# 4

K x 8  M6×30mm	U x 1  4mm	S x 2  Ø13mm
---	---	---



# 5

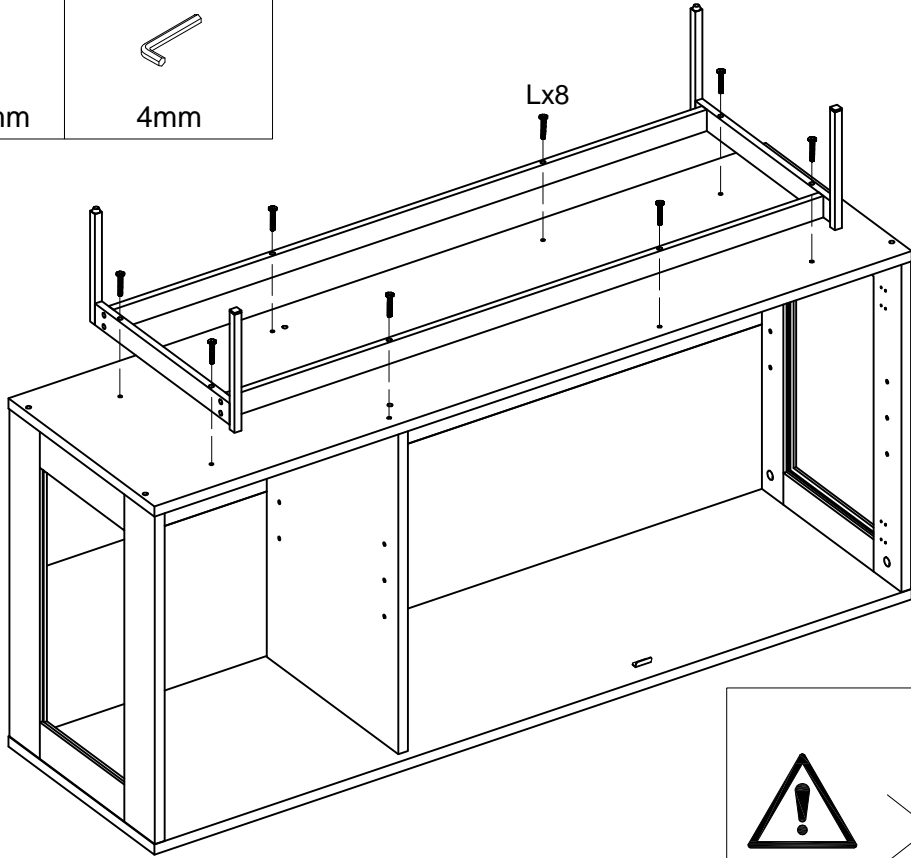

L x 8  M6x48mm	U x 1  4mm
---	---



Ux1  
Kx8 100%





Ux1  
Lx8 100%



K  L 



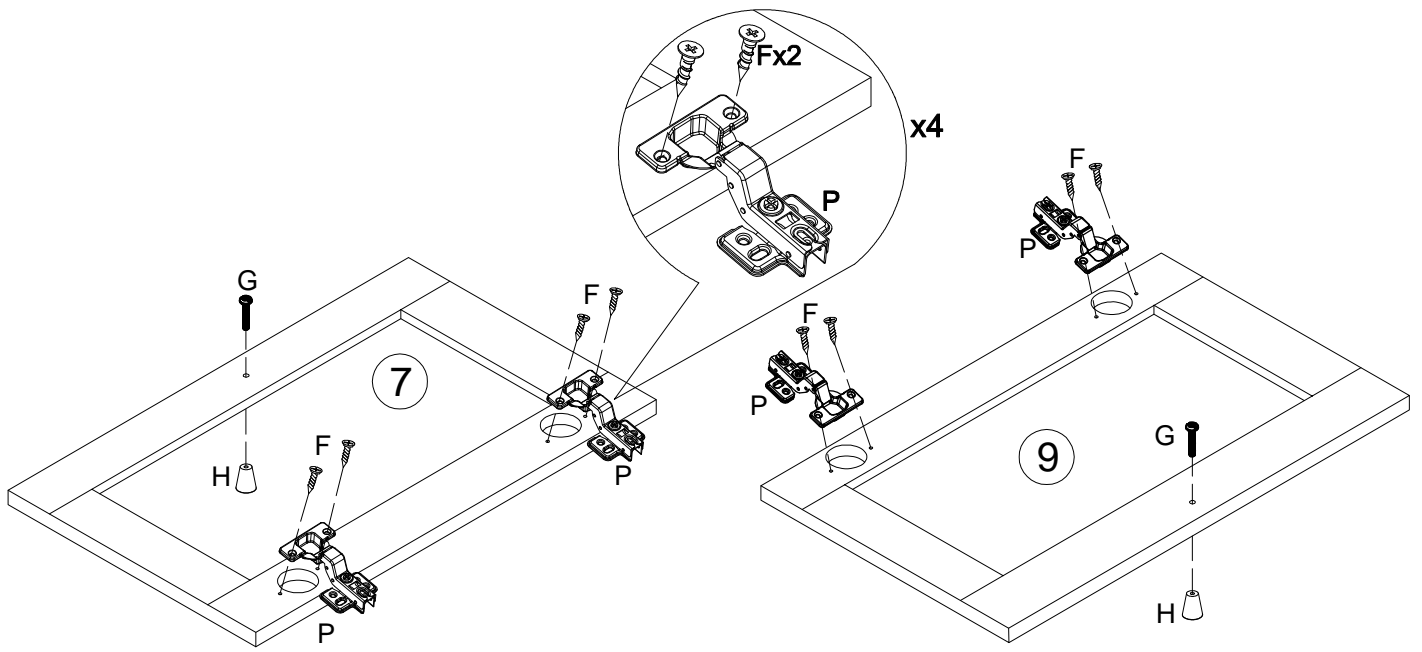

M6x30mm M6x48mm

# 6

F x 8  3.5x14mm	G x 2  4x22mm	H x 2  Ø20x20mm	P x 4  FK17	
--	--	--	--	---

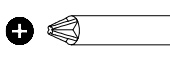

# 7

F x 4  3.5×14mm	G x 1  4×22mm	H x 1  Ø20×20mm	Q x 2  FK9	
--	--	--	---	---

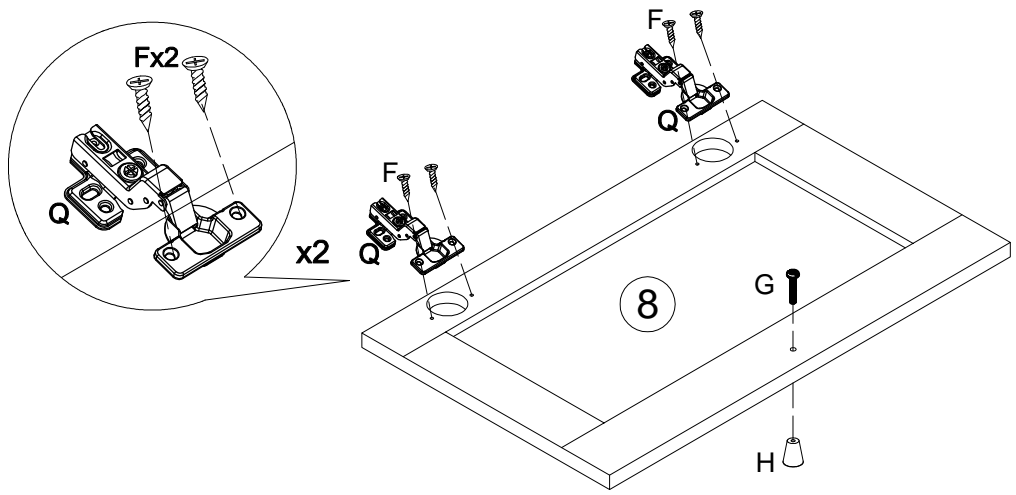

# 8

N x 8  Ø5×20mm
---

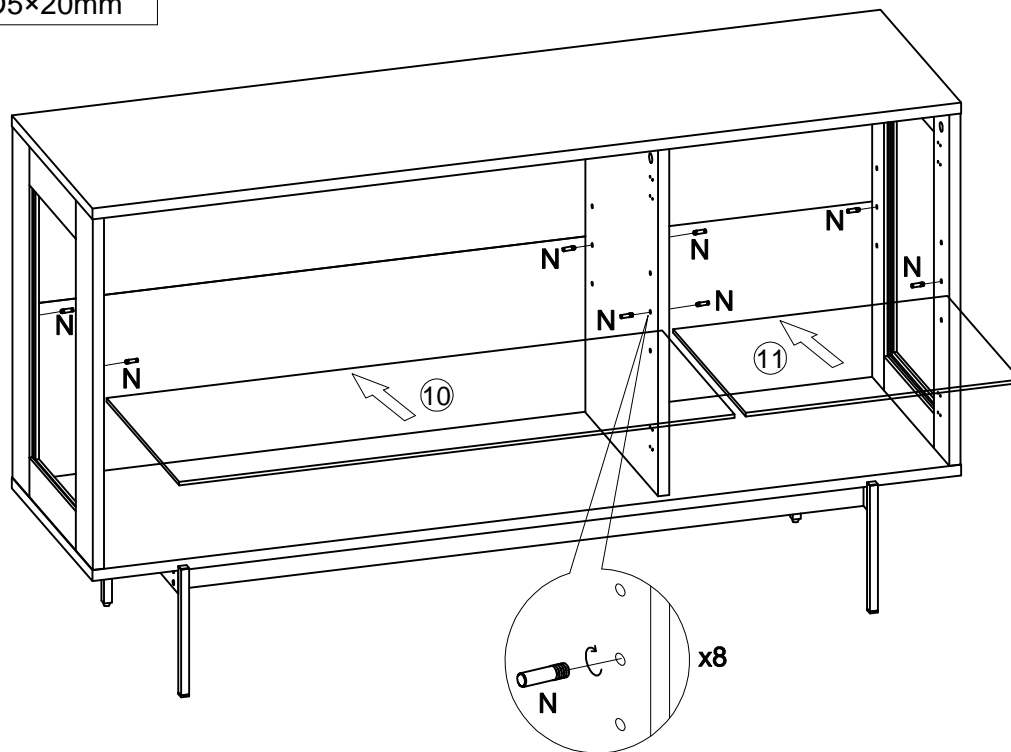

# 9

F x8  
3.5x14mm

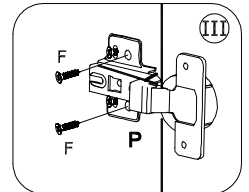
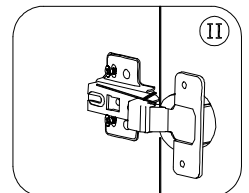
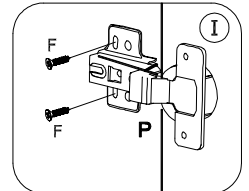
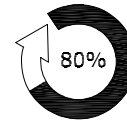
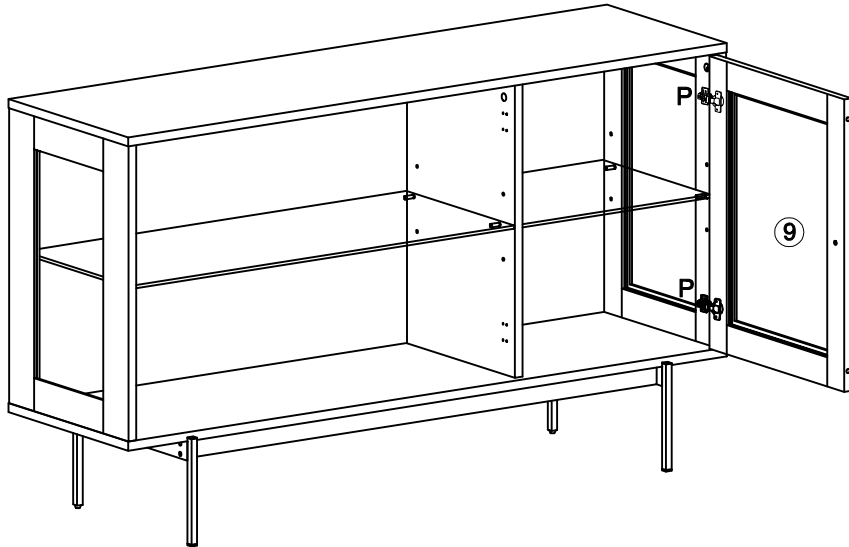

# 10

F x8  
3.5x14mm

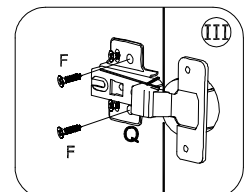
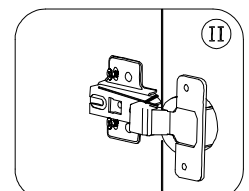
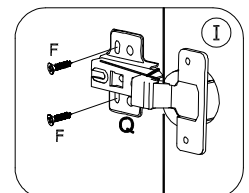
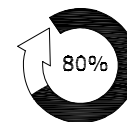
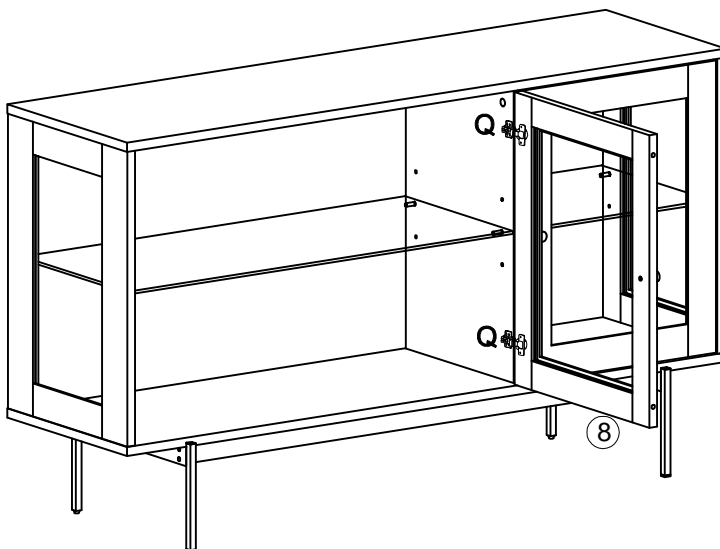



# 11

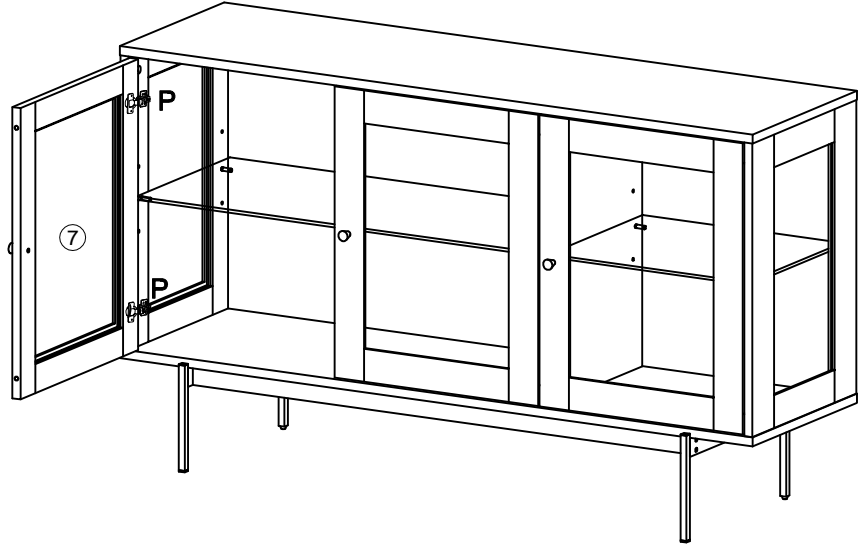
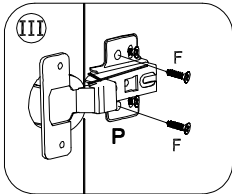
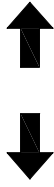
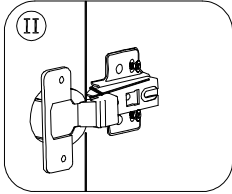
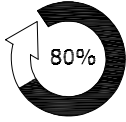
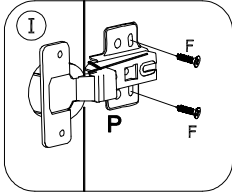
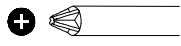
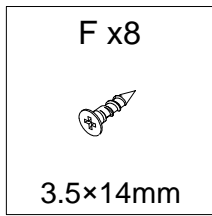

# 12

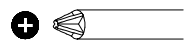
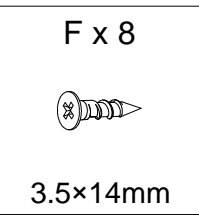
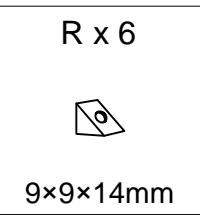
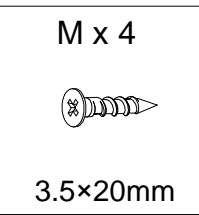
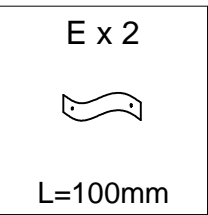
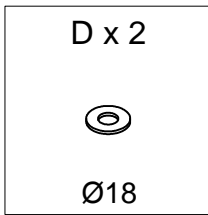

XX=YY

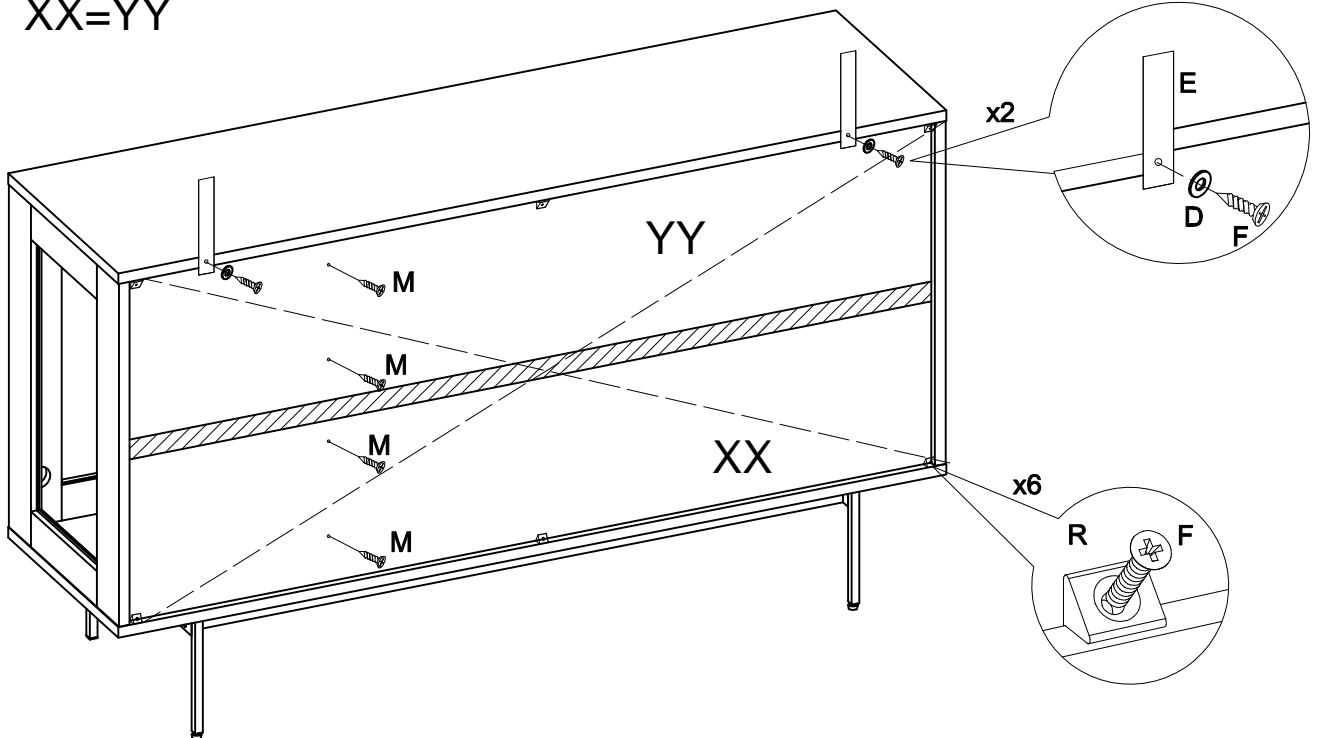

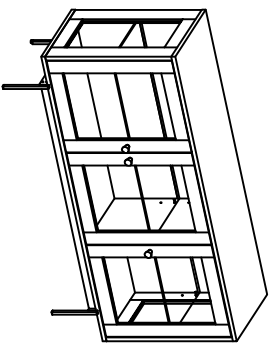

1.

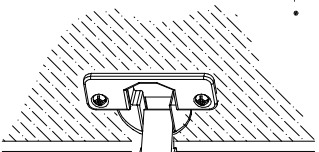

2.

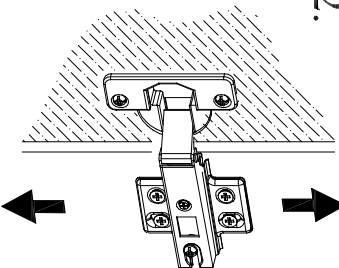

3.

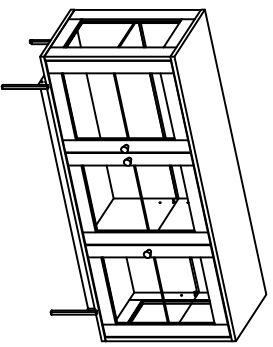
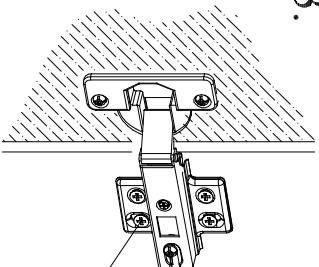

1.

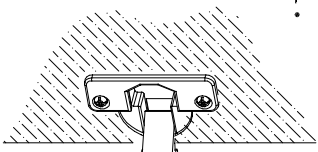

2.

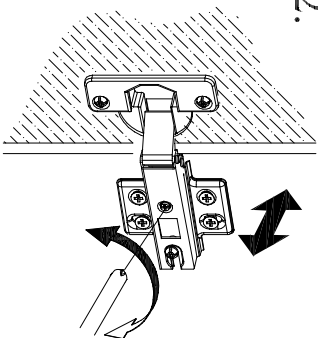

3.

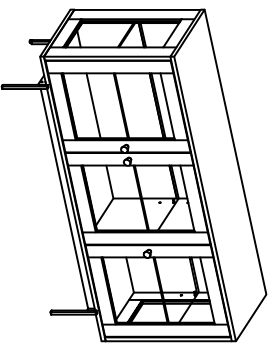
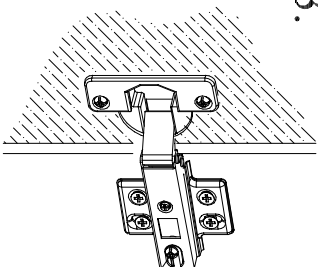

1.

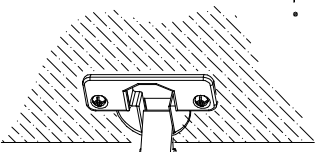

2.

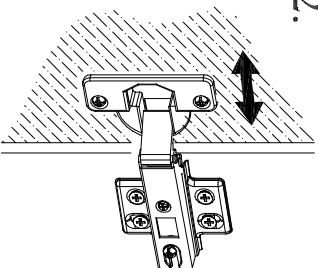

3.

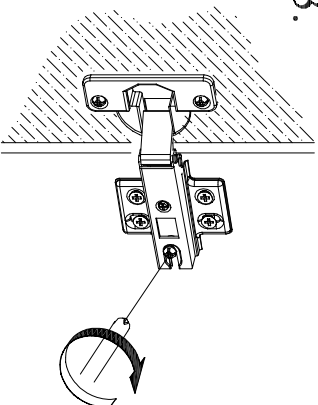

# 14

D x 2



Ø18

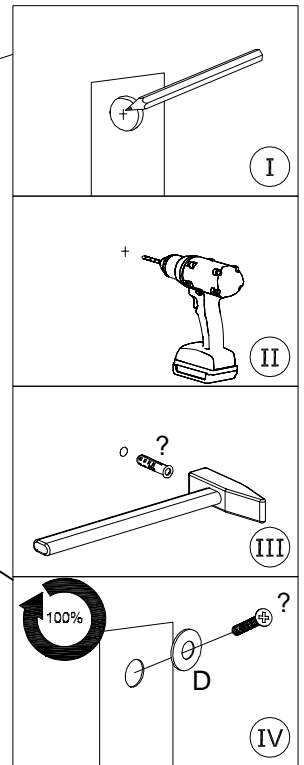
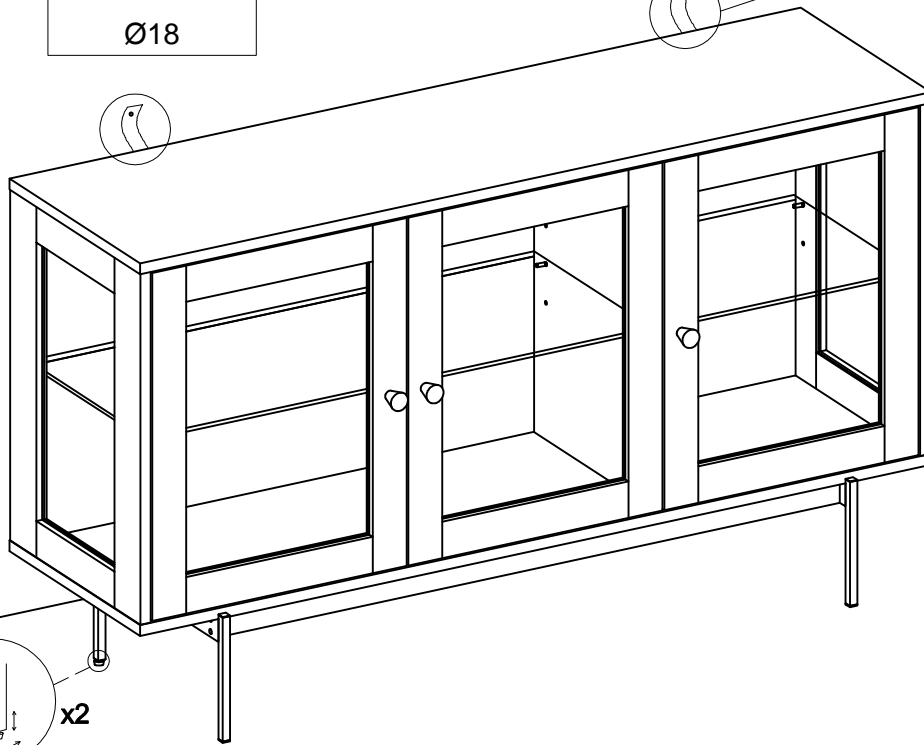

# 15

