

Newcastle high glass cabinet

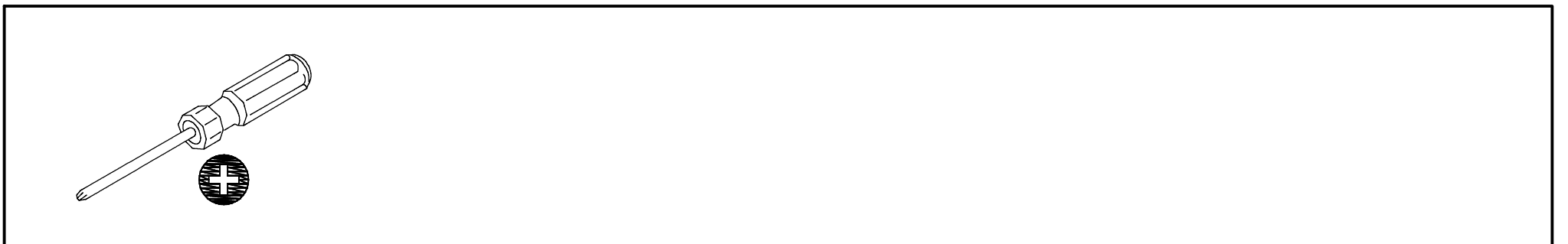

			✓
①	1	1774x400x60	
②	1	1774x400x60	
③	1	802x402x60	
④	3	785x345x15	
⑤	1	760x400x20	
⑥	1	1605x375.5x20	
⑦	1	1605x375.5x20	
⑧	1	1620x402x20.6	
⑨	1	1620x390x20.6	

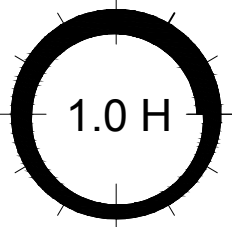

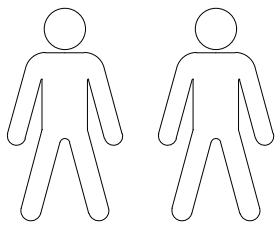
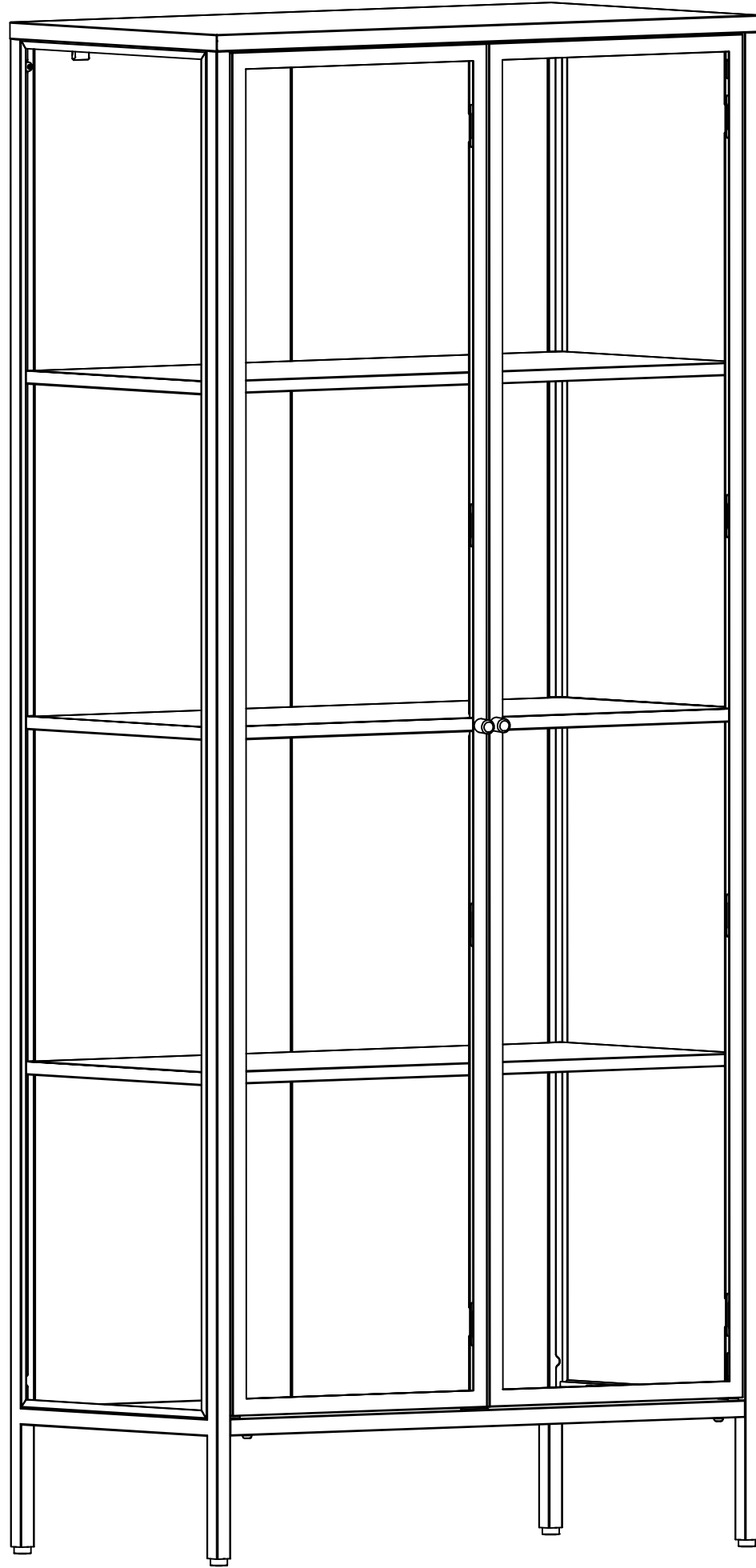
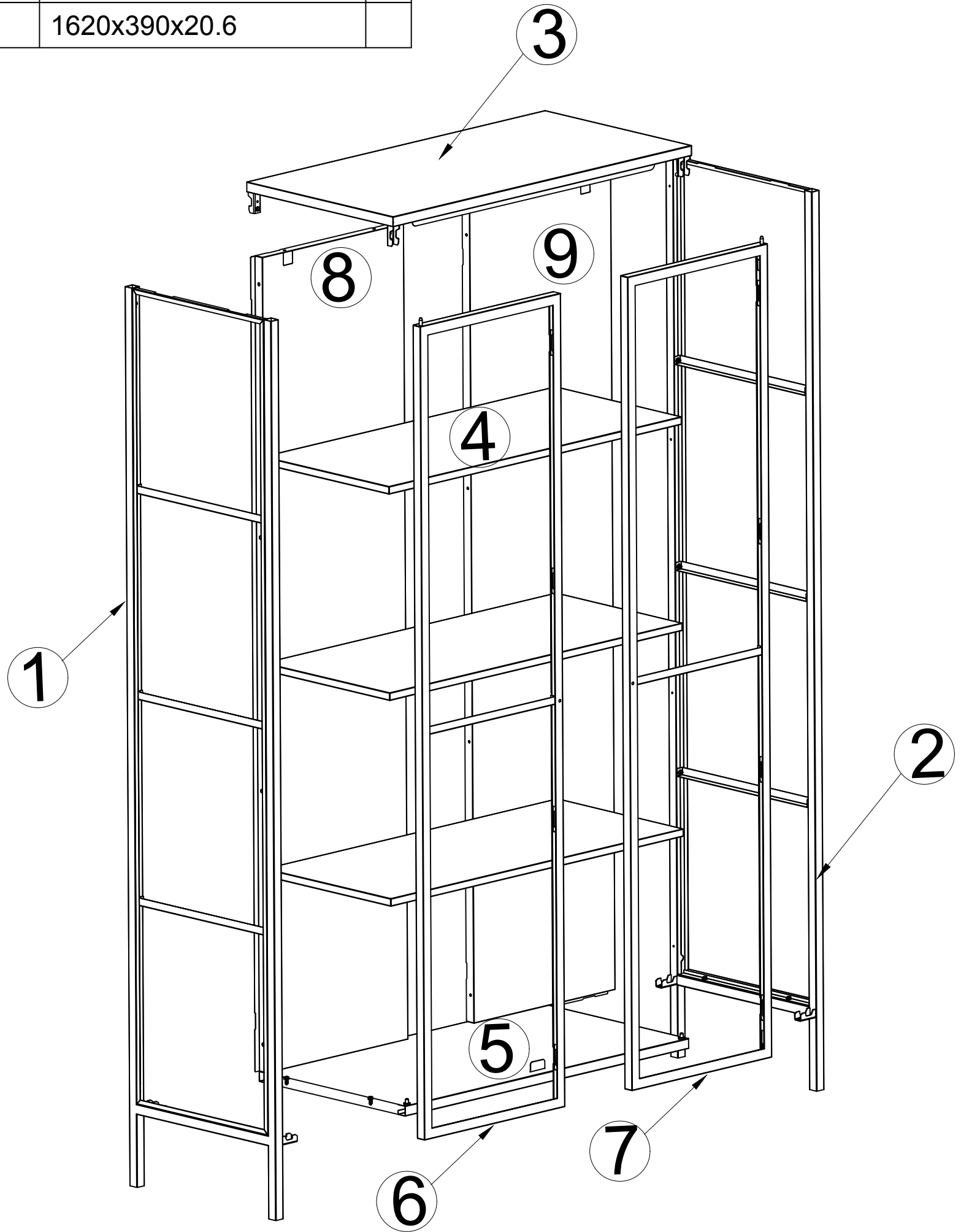
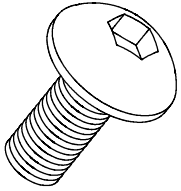
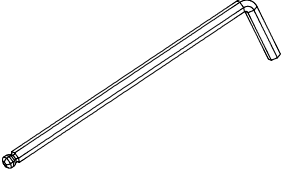
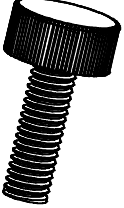
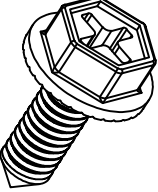
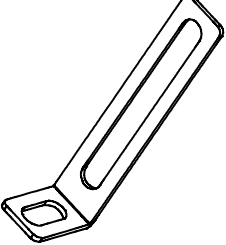
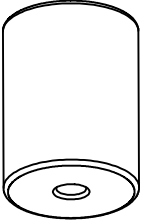
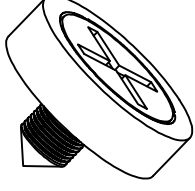
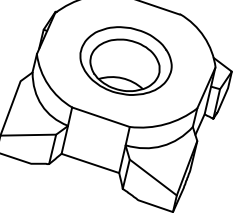
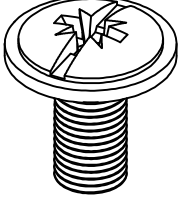
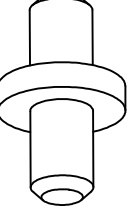
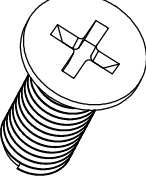

<p>A X 12</p>  <p>M6 X 12 mm</p>	<p>B X 1</p>  <p>4mm</p>	<p>C X 4</p>  <p>M8/Ø20mm</p>	<p>D X 12</p>  <p>M4 X 12 mm</p>	<p>E X 2</p>  <p>75x25x15mm</p>
<p>F X 2</p>  <p>Ø15 X 20 mm</p>	<p>G X 4</p>  <p>Ø13.5/M3.5mm</p>	<p>H X 4</p>  <p>M4X4.2mm</p>	<p>J X 4</p>  <p>M4 X 8 mm</p>	<p>K X 2</p>  <p>Ø6x20mm</p>
<p>L X 2</p>  <p>M4 X 10 mm</p>				

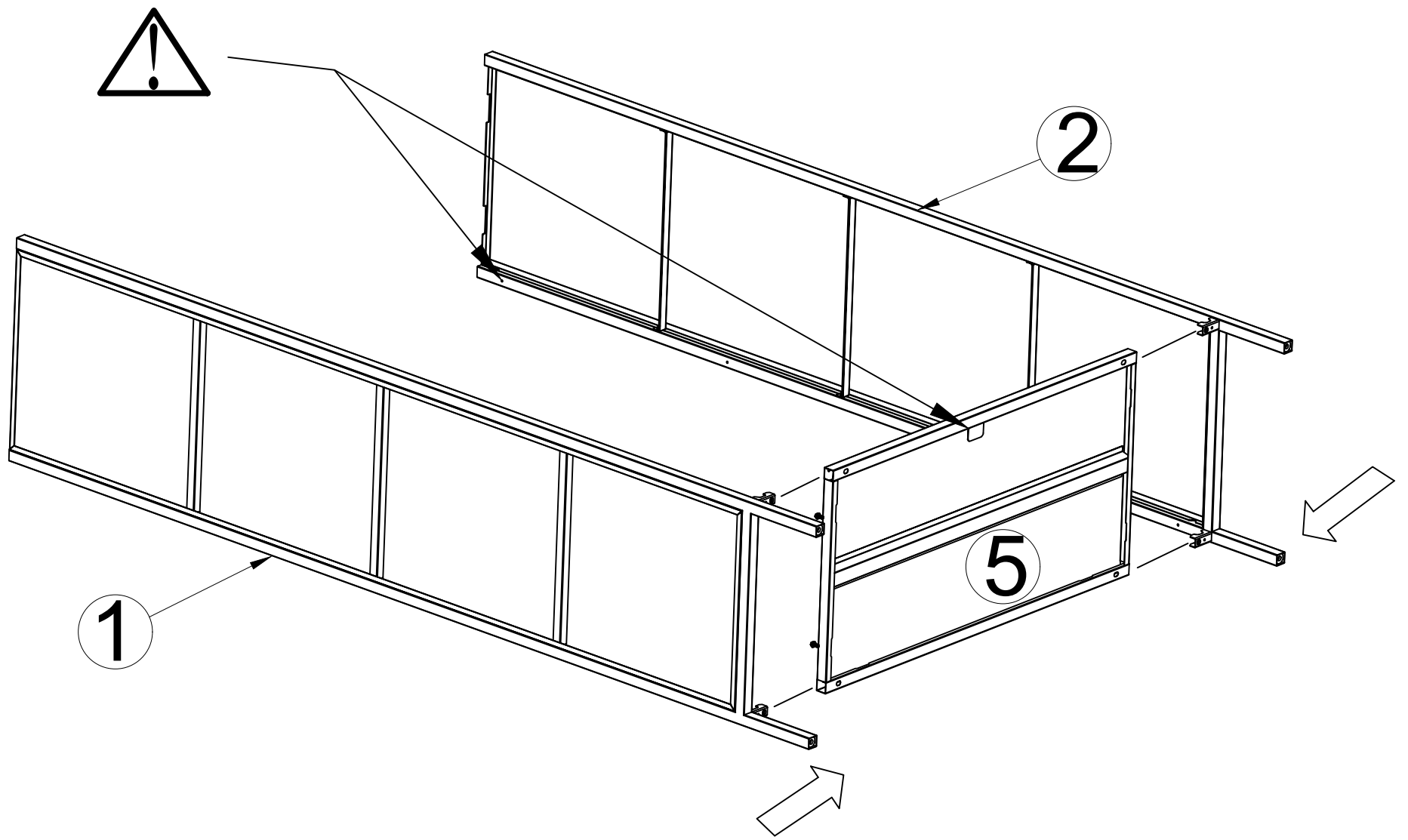
1

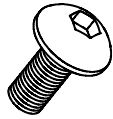
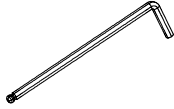

2

AX 4  M6 X 12 mm	BX 1  4mm	CX 4  M8/Ø20mm
---	--	---

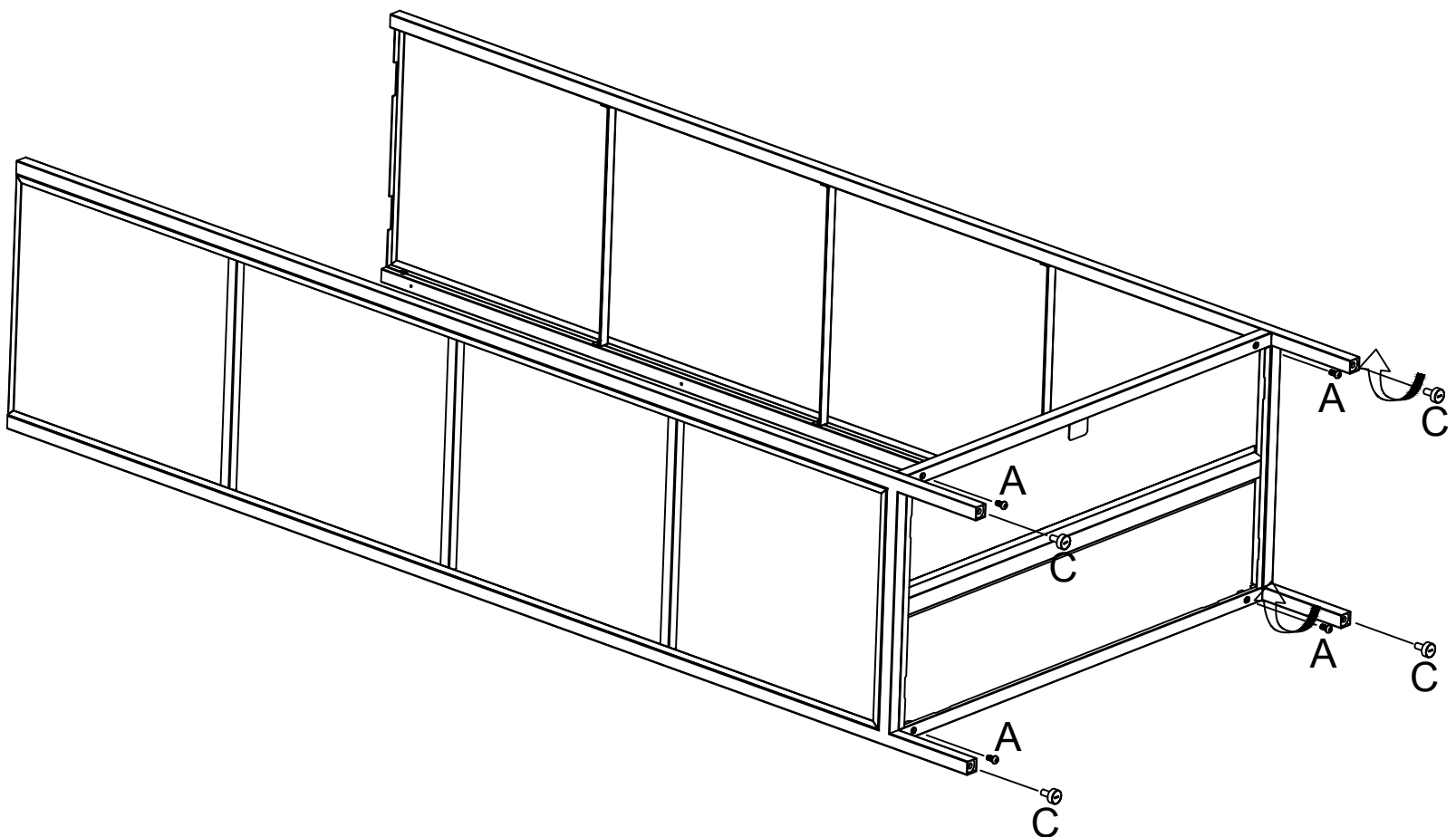

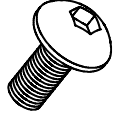
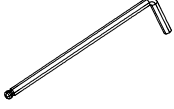

3

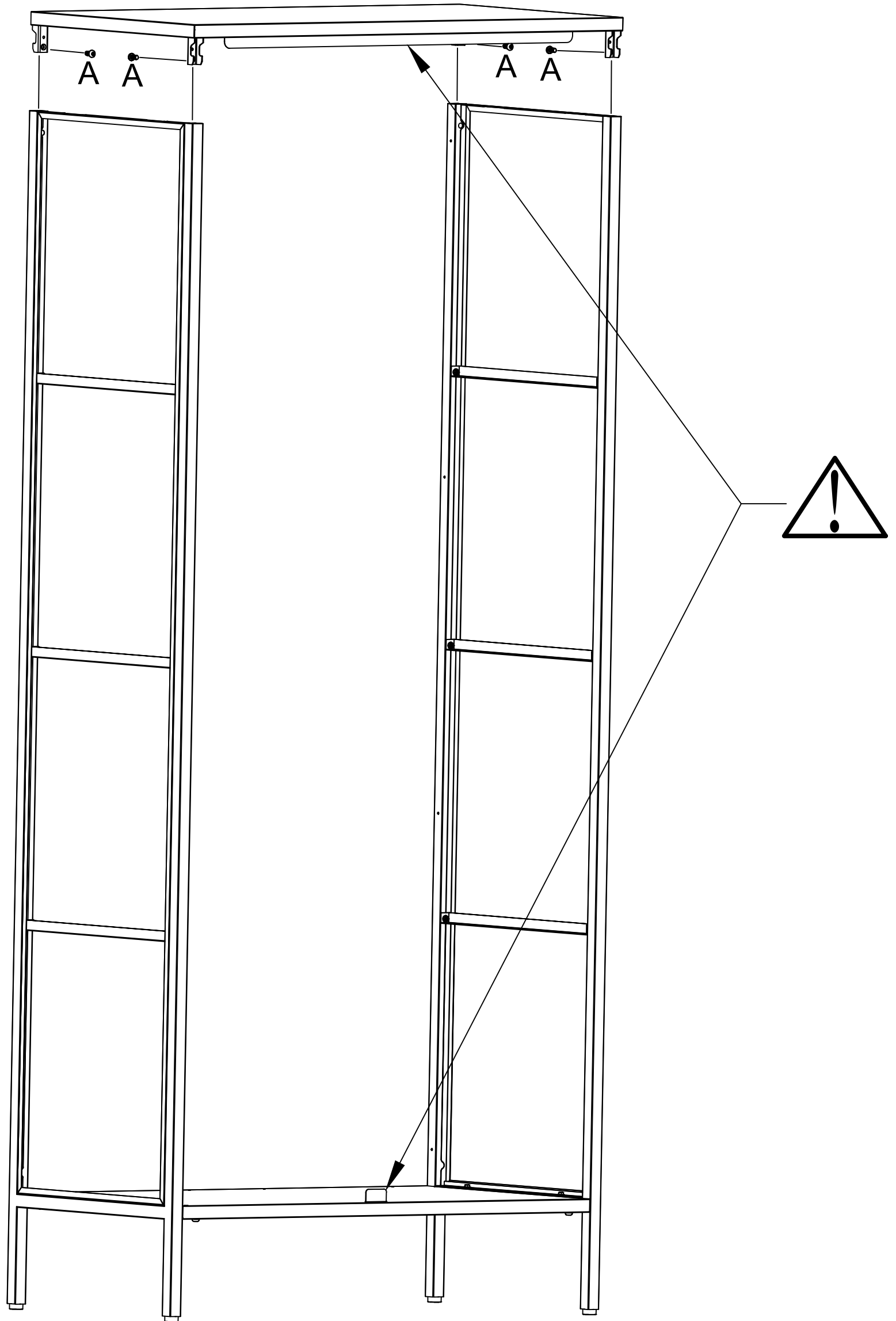
AX4  M6 X 12 mm	BX1  4mm
--	---



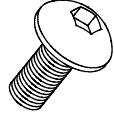
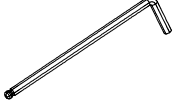
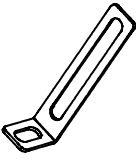

4

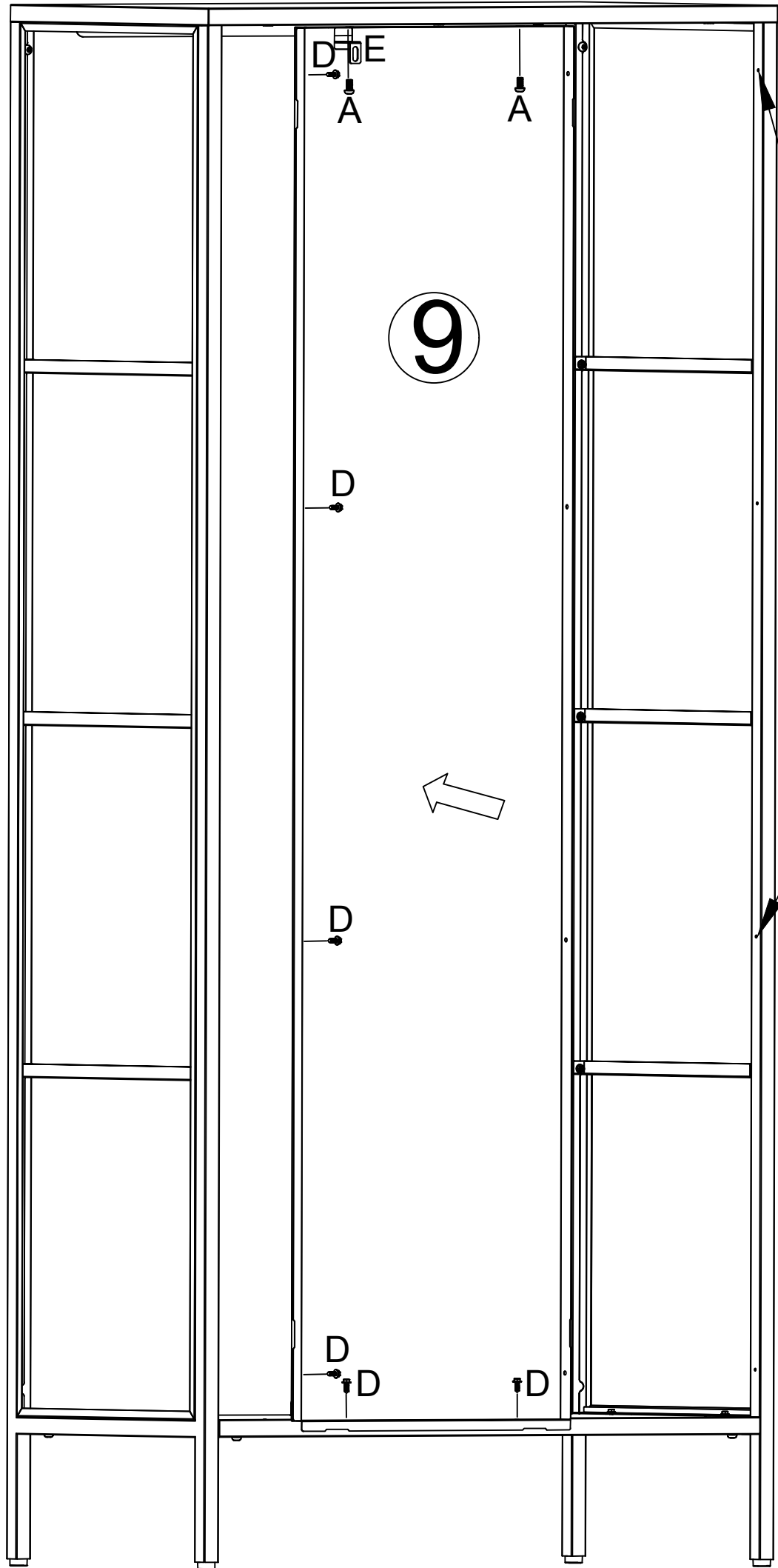
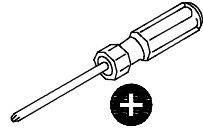
AX2  M6 X 12 mm	BX1  4mm	EX1  75x25x15mm	DX6  M4 X 12 mm
--	---	--	--

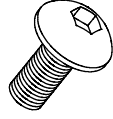
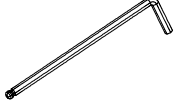
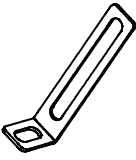

5

AX2  M6 X 12 mm	BX1  4mm	EX1  75x25x15mm	DX6  M4 X 12 mm
--	---	--	--

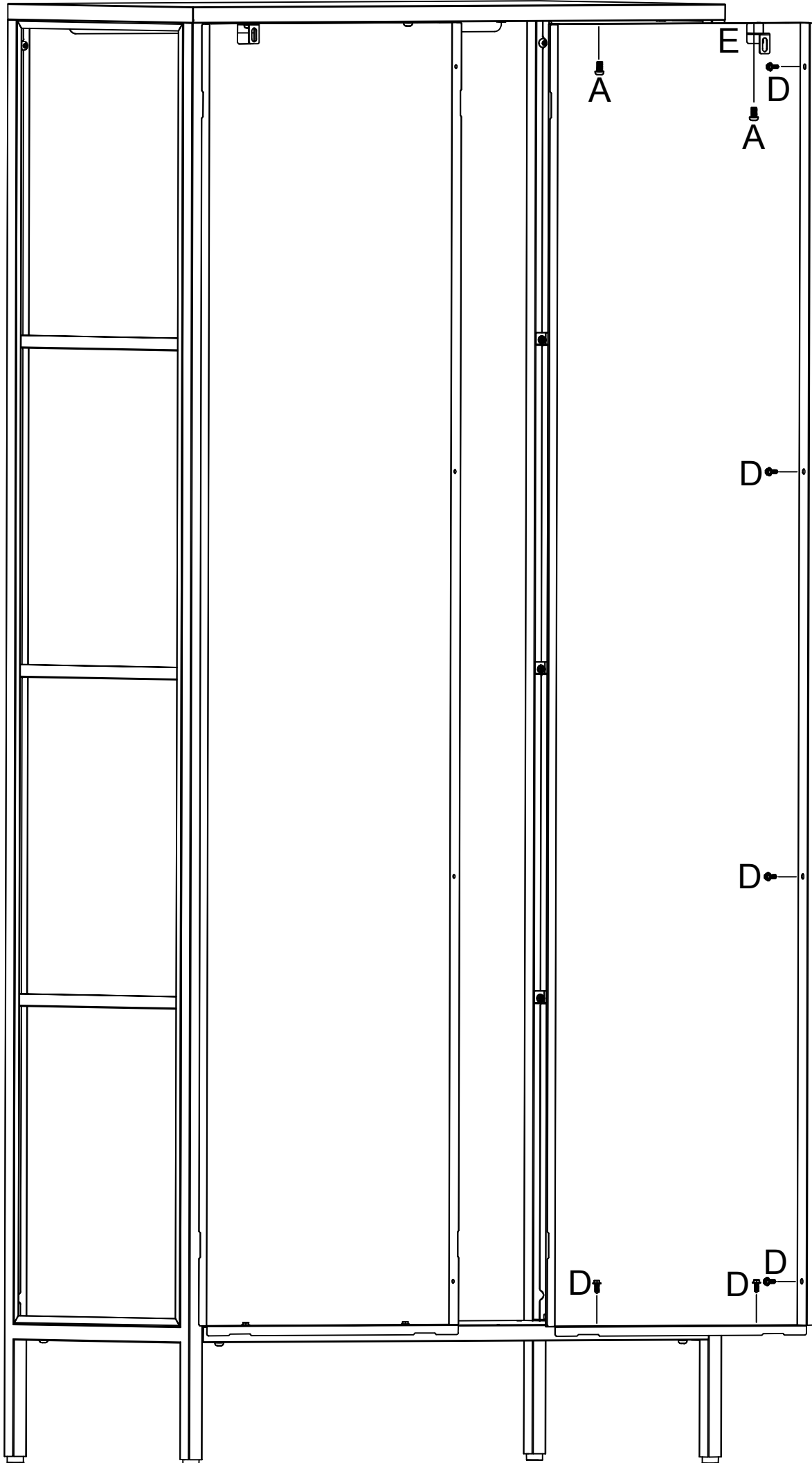
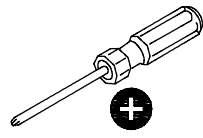

6

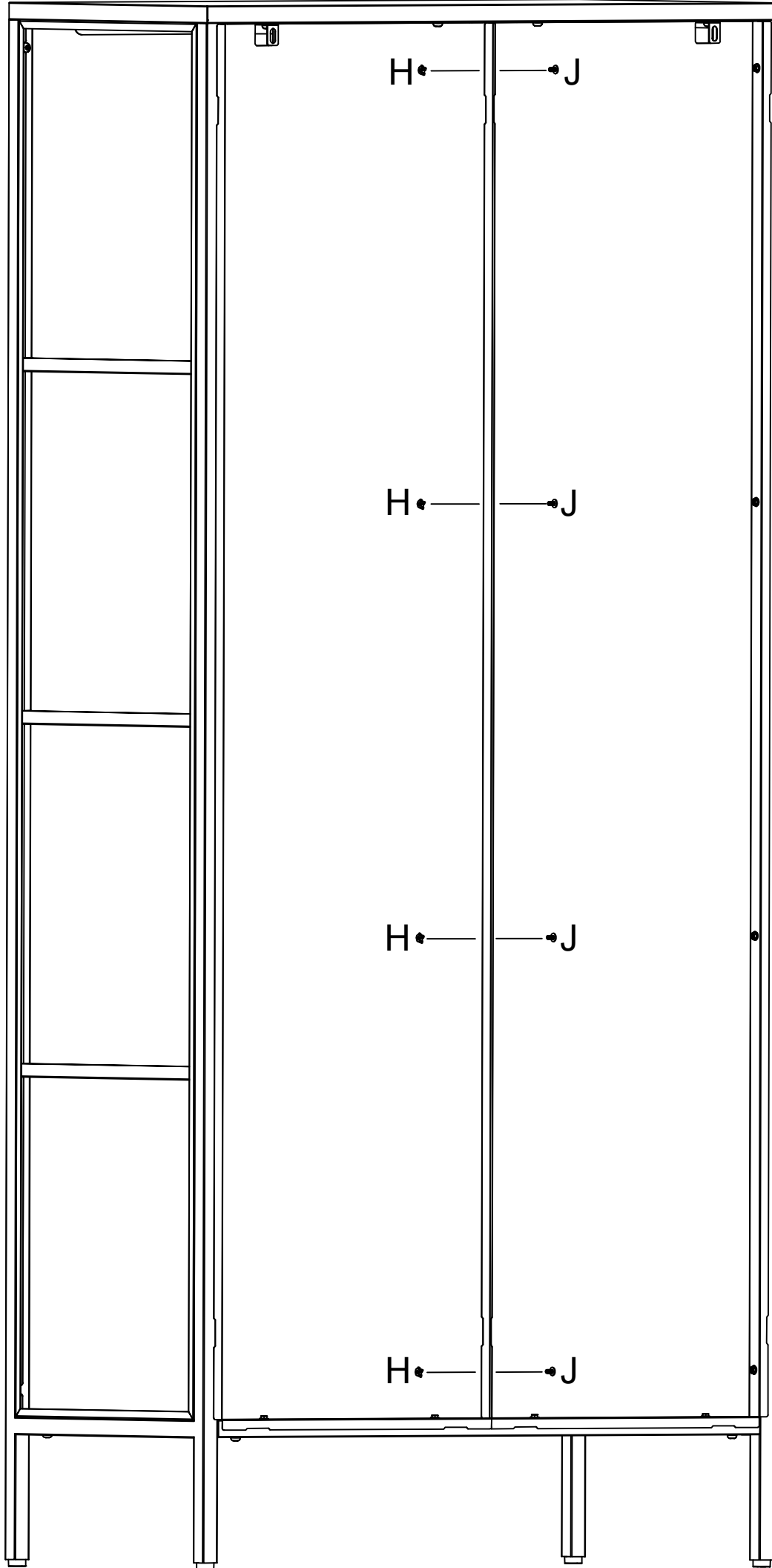
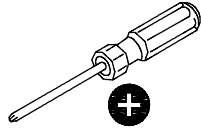
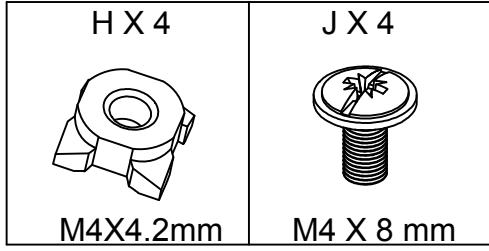

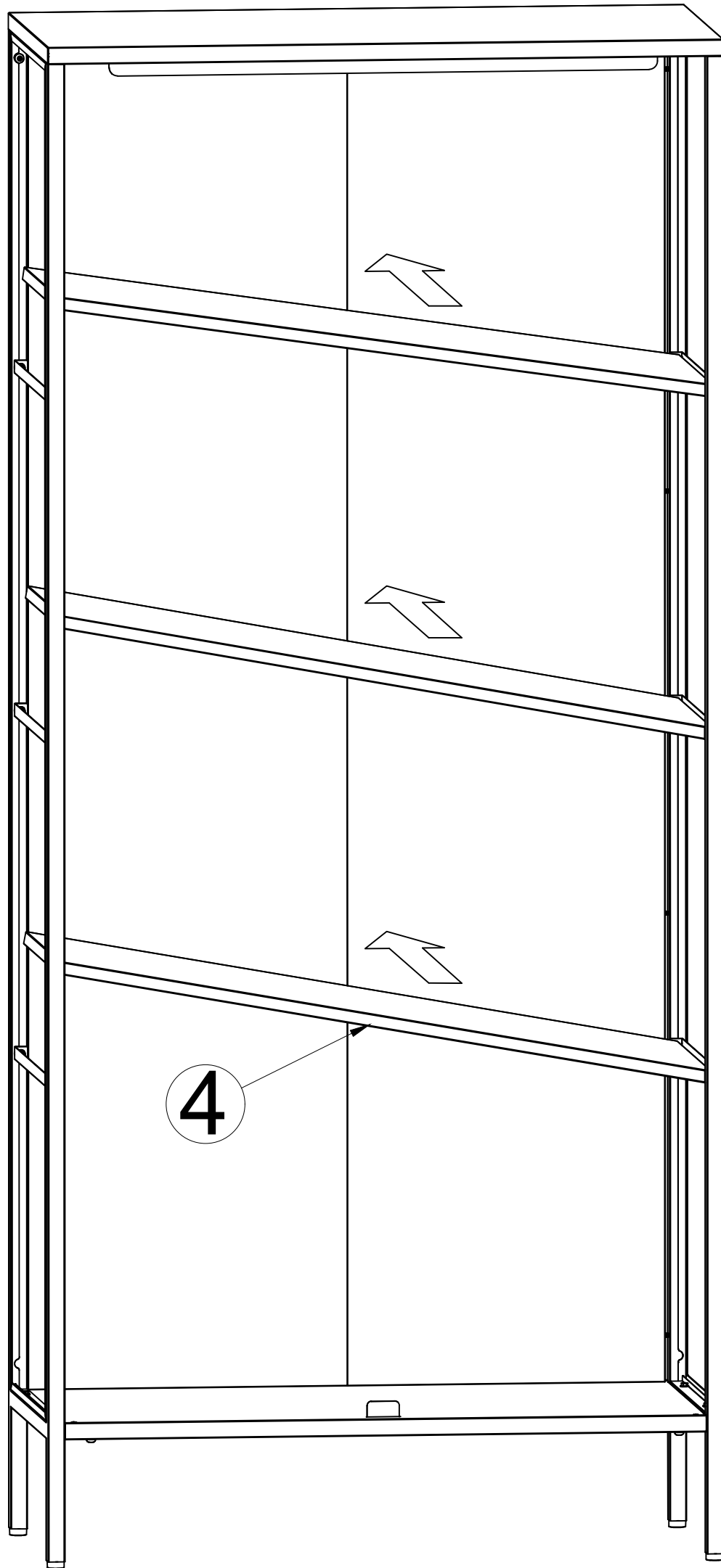

7

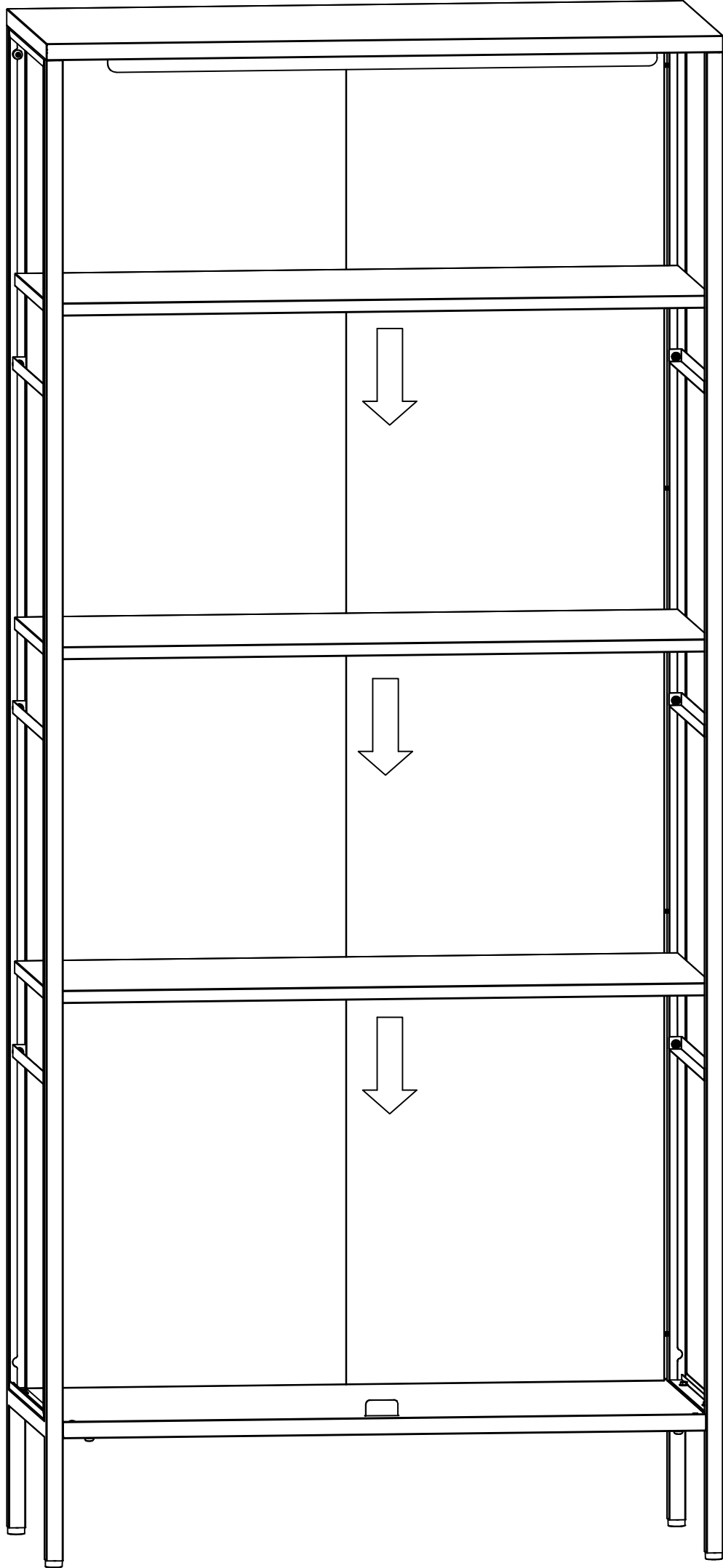



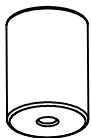
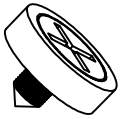

9

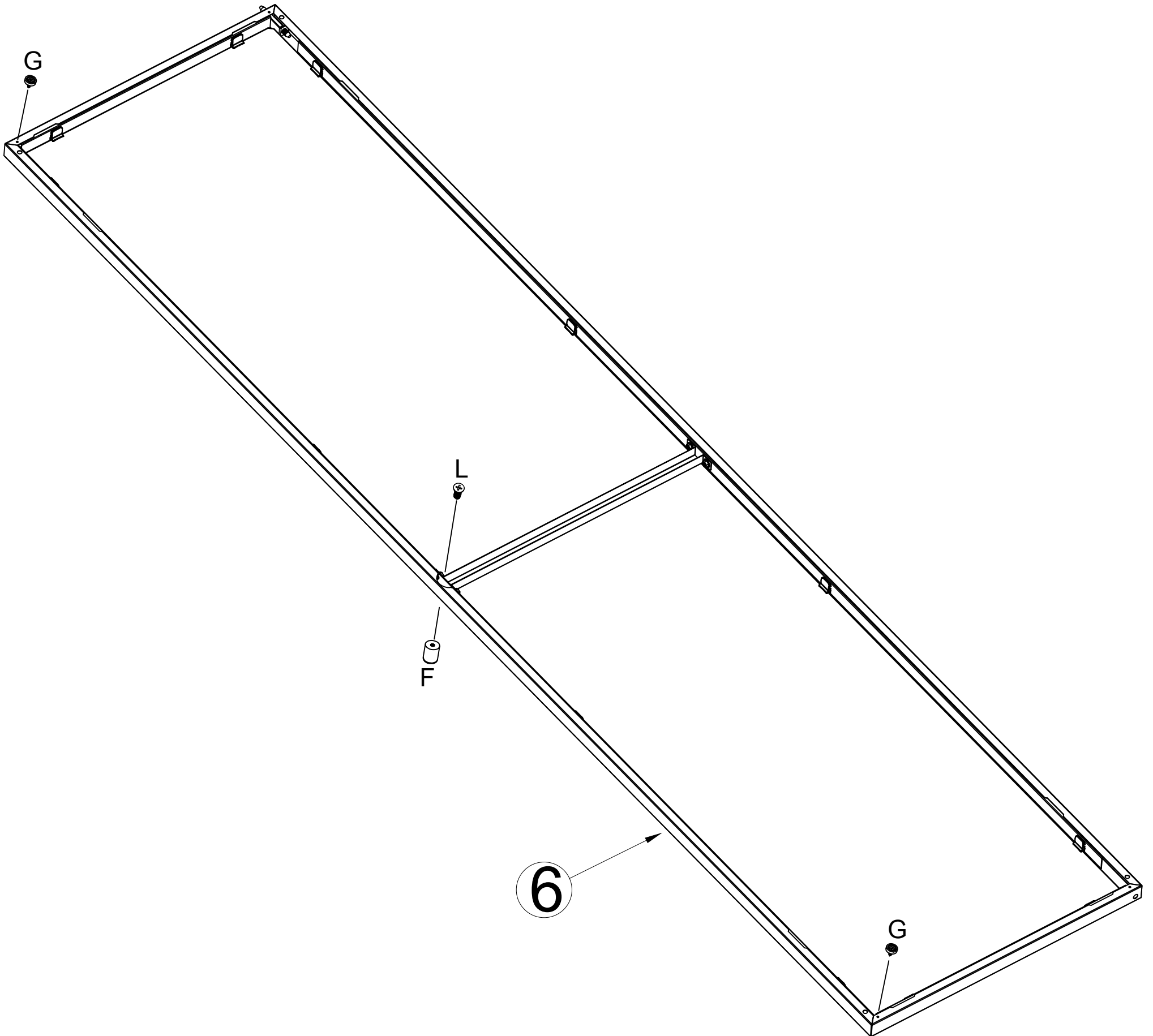
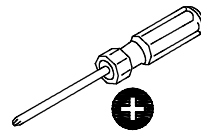
FX 1  Ø15 X 20 mm	GX 2  Ø13.5/M3.5mm	LX 1  M4 X 10 mm
--	---	---

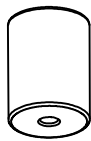
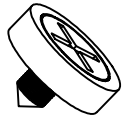

10

FX1  Ø15 X 20 mm	GX2  Ø13.5/M3.5mm	LX1  M4 X 10 mm
---	--	--

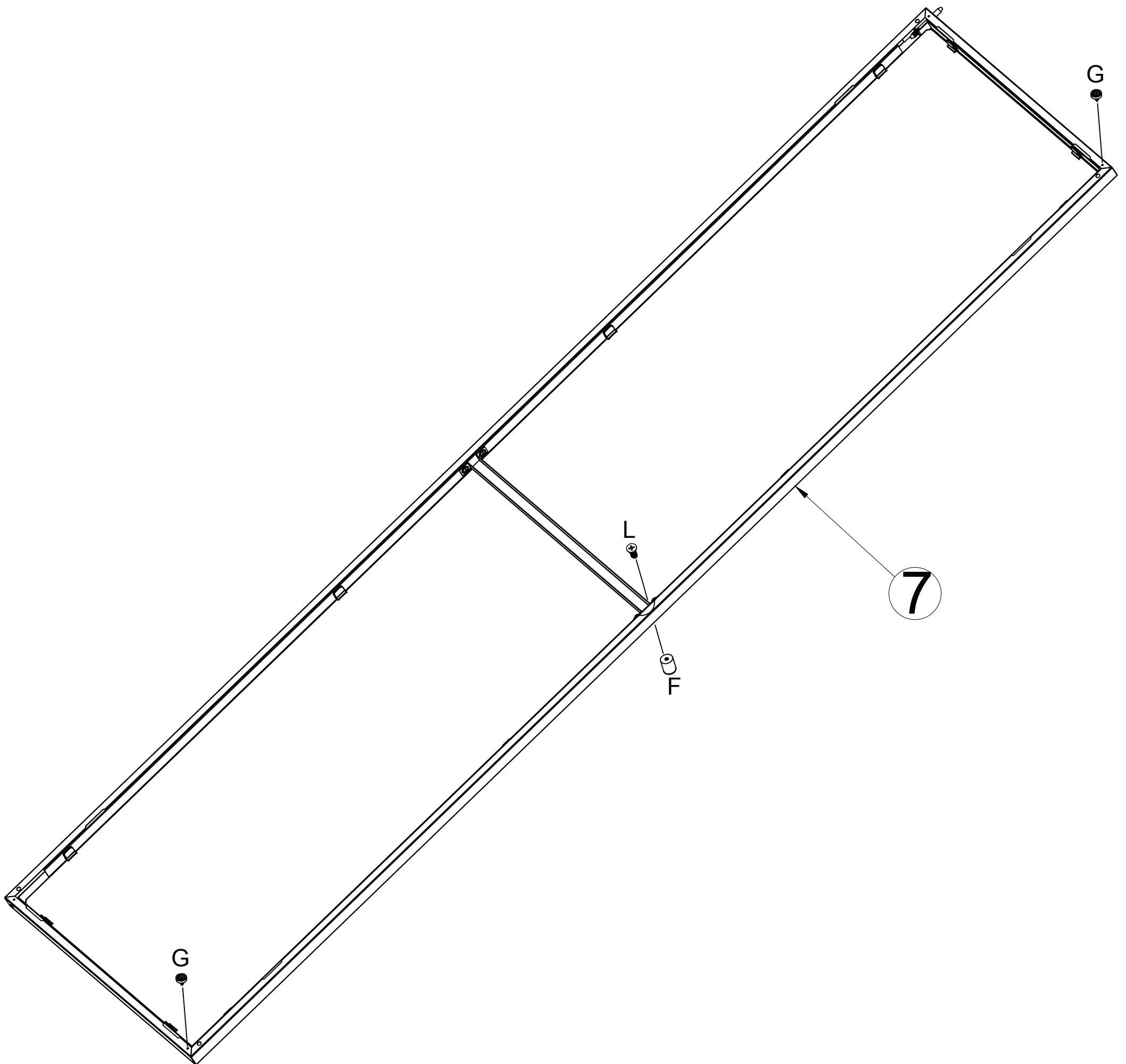
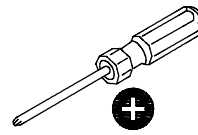

11

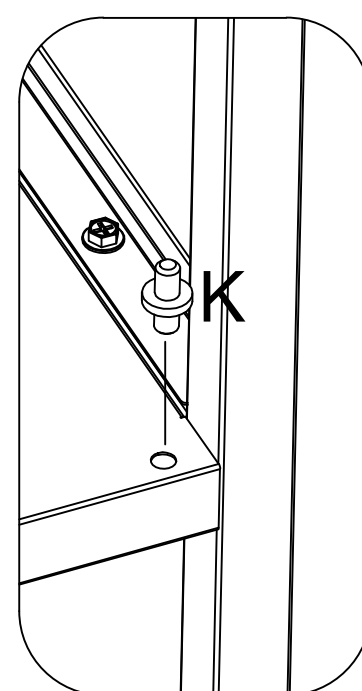
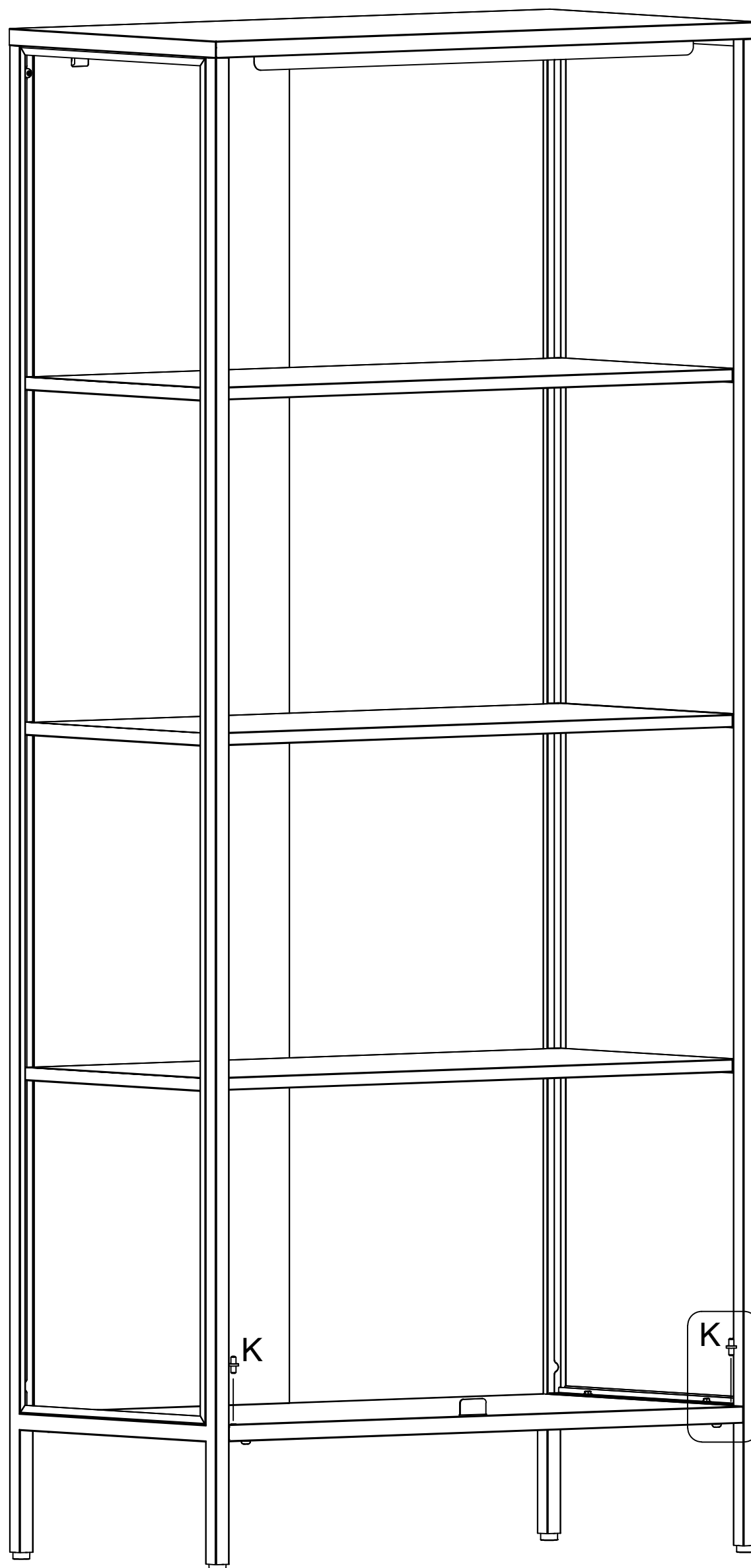
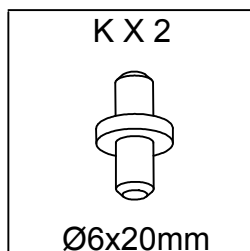

12

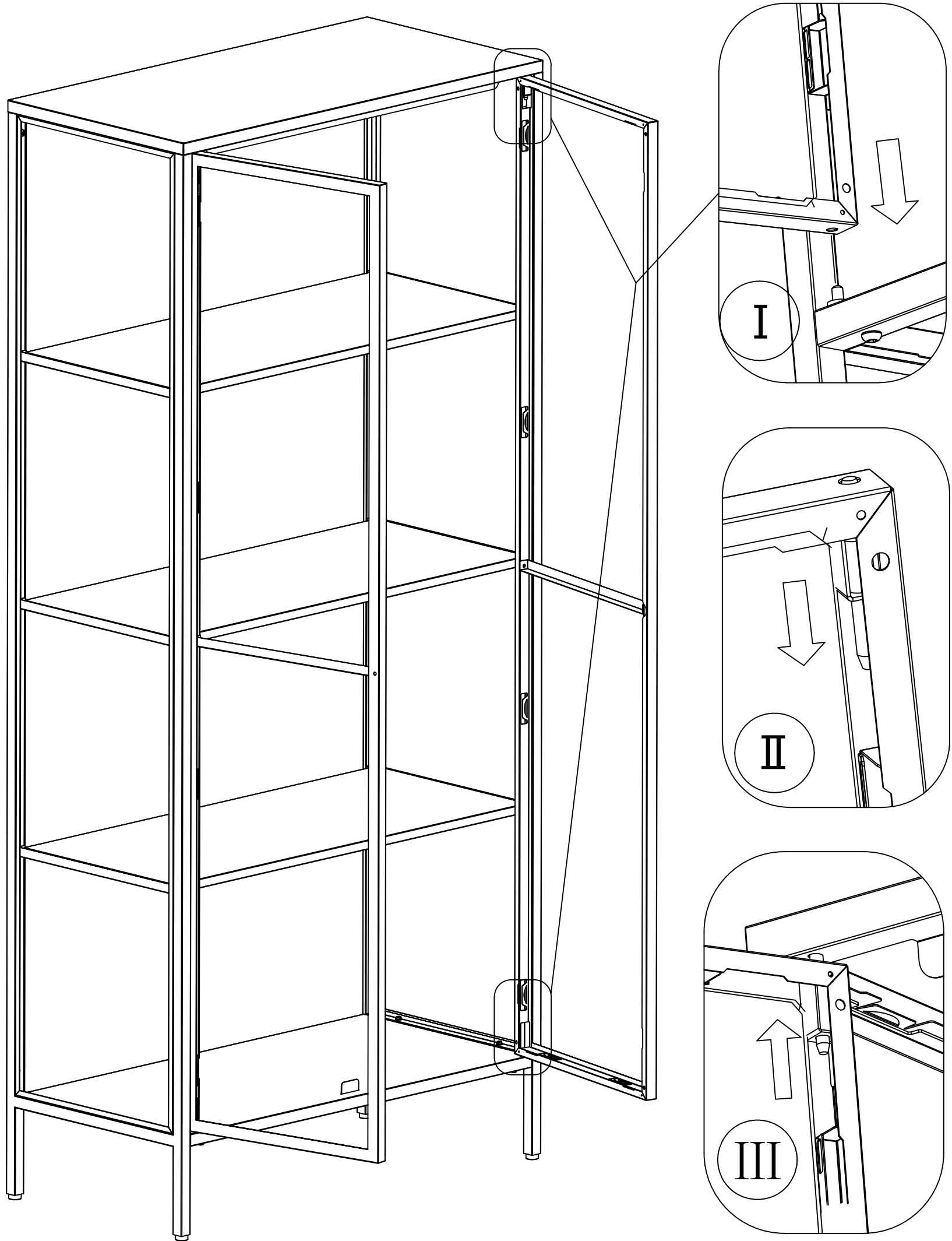

13

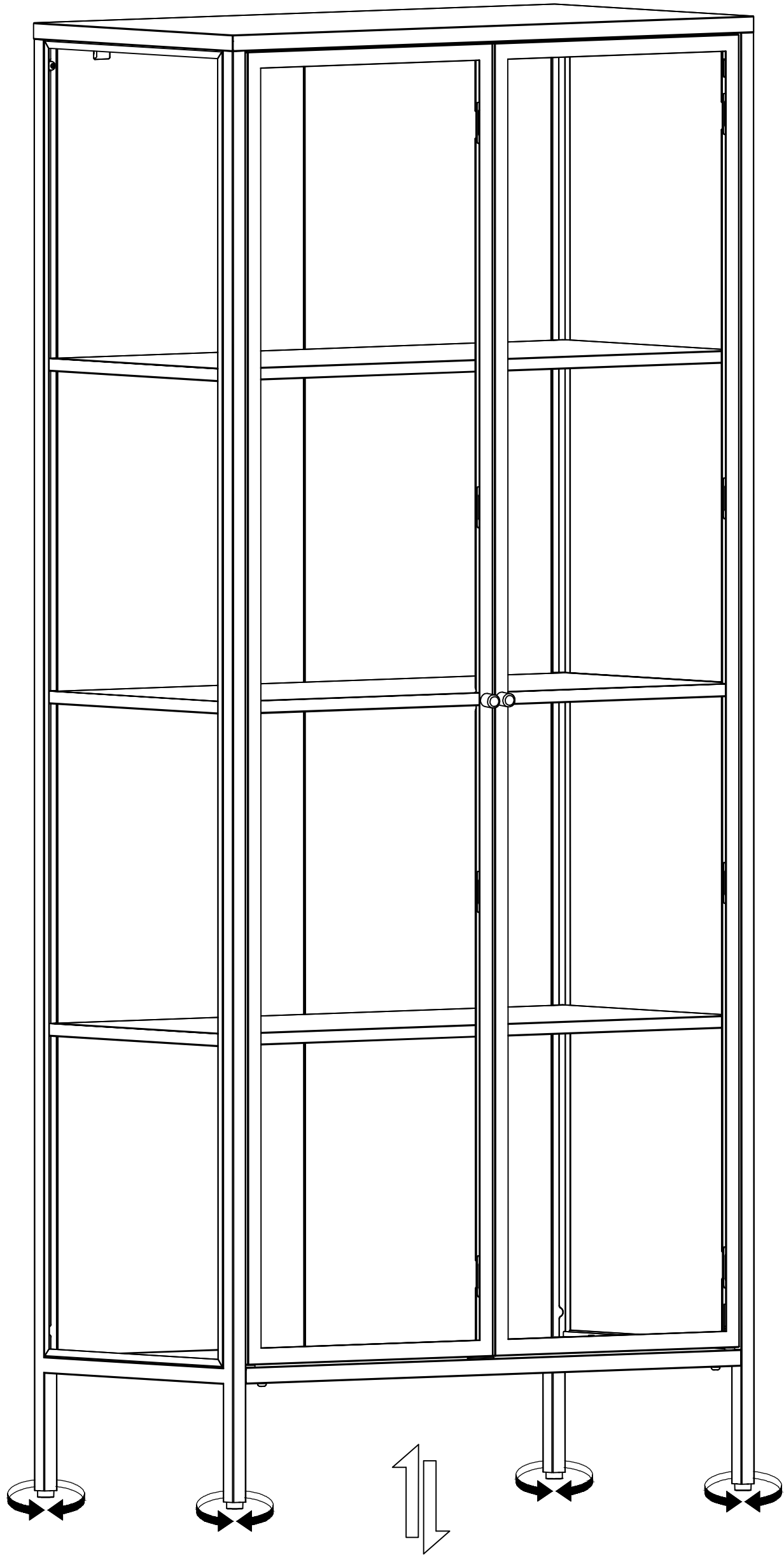

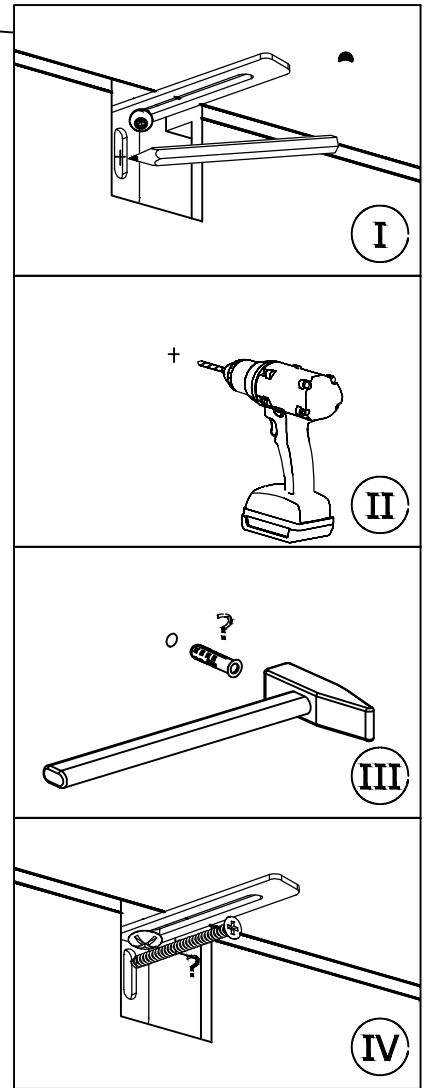
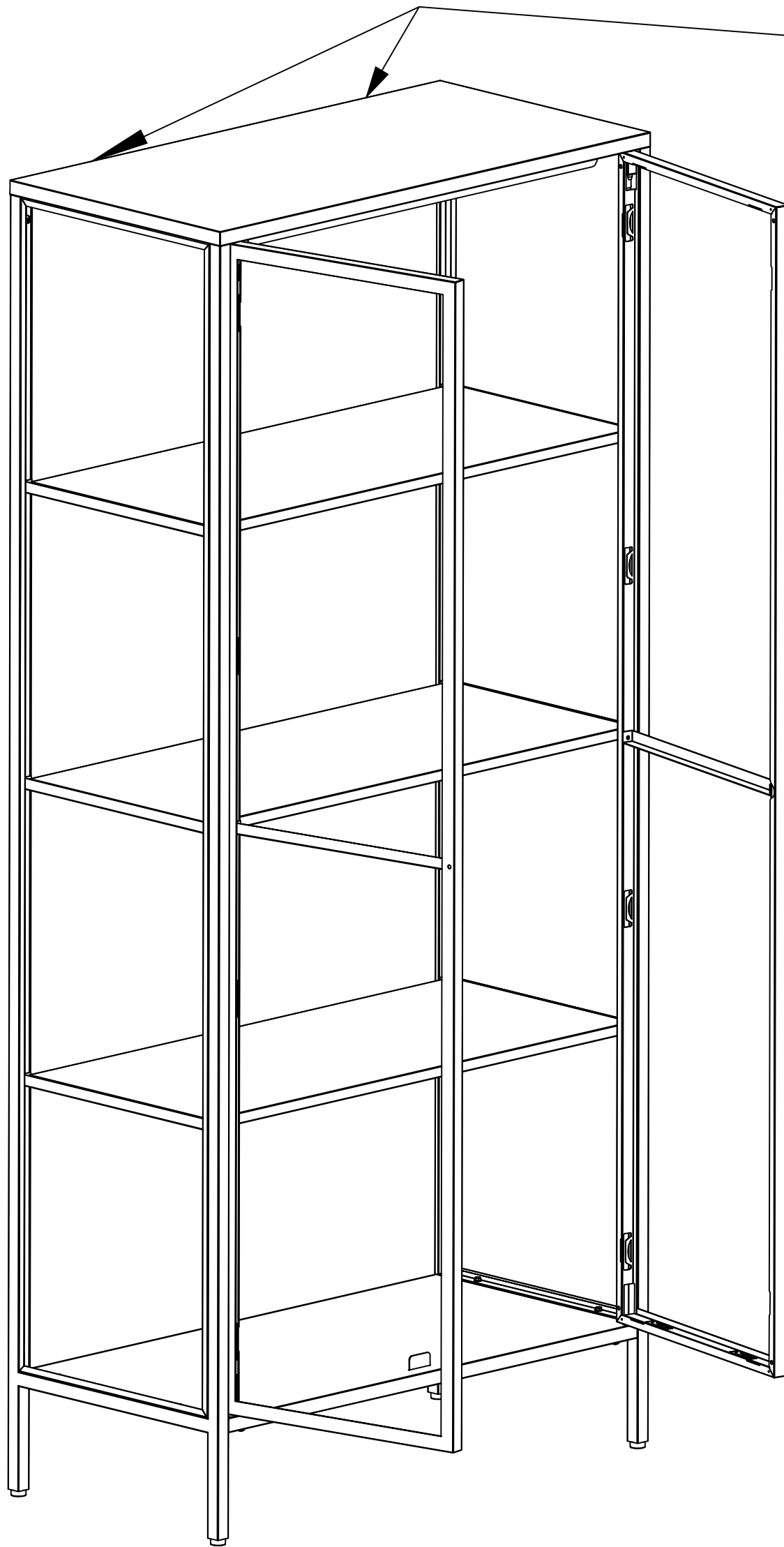

15

