

ALPHA RUN 200 TM1037-100
ALPHA RUN 400 TM1038-100



Abb. Ähnlich

KETTLER



Montageanleitung **DE**
Assembly Instructions **EN**
Instructions de montage **FR**

INHALT

DE WICHTIGE HINWEISE	4
LIEFERUMFANG	10
TYPENSCHILD	20
ERSATZTEILBESTELLUNG	
TM1037-100 ALPHA RUN 200	21
TM1038-100 ALPHA RUN 400	23
EN IMPORTANT INSTRUCTIONS	6
SCOPE OF DELIVERY	10
TYPE LABEL	20
SPARE PARTS ORDER	
TM1037-100 ALPHA RUN 200	21
TM1038-100 ALPHA RUN 400	23
FR REMARQUES IMPORTANTES	8
FOURNITURES	10
PLAQUE SIGNALÉTIQUE	20
COMMANDE DE PIÈCES DÉTACHÉES	
TM1037-100 ALPHA RUN 200	21
TM1038-100 ALPHA RUN 400	23

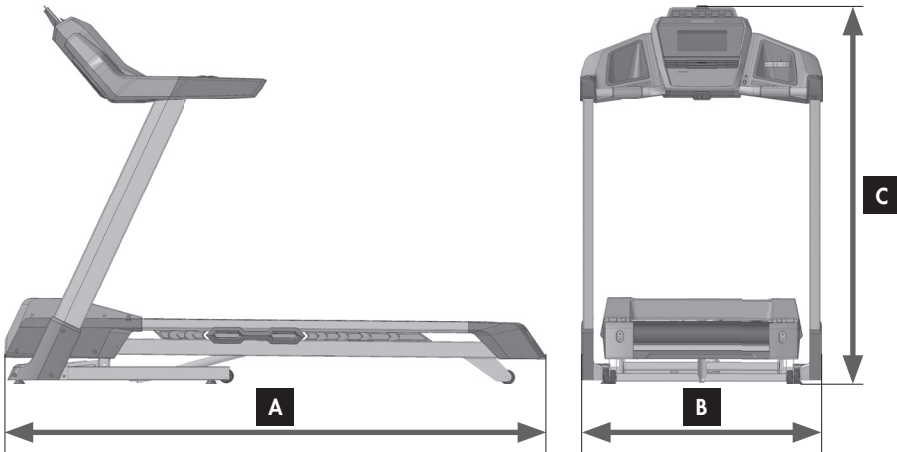

TM1037-100 ALPHA RUN 200 **87 kg**
 A x B x C (m) 1,82 x 0,85 x 1,45



max. 130 kg

TM1038-100 ALPHA RUN 400 **95 kg**
 A x B x C (m) 1,89 x 0,87 x 1,43



max. 140 kg

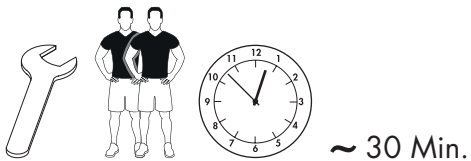





~ 30 Min.

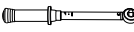

Wichtig! Bitte lesen Sie die Anweisungen vor der Montage und der ersten Benutzung aufmerksam durch. Sie erhalten wichtige Hinweise für Ihre Sicherheit sowie den Gebrauch und die Wartung des Gerätes. Bewahren Sie diese Anleitungen zur Information bzw. für Wartungsarbeiten oder Ersatzteilbestellungen sorgfältig auf. Händigen Sie diese Anleitungen bei einem Besitzerwechsel des Gerätes mit aus.
Dieses Symbol  weist auf einen wichtigen Warnhinweis hin.
Diese Anleitung kann auch unter www.kettlersport.com heruntergeladen werden.

1.0 BENUTZERINFORMATION

- **Achtung!** Beachten Sie auch unbedingt die Hinweise in den Heften „Sicherheitshinweise und Informationen zum Gebrauch Laufbänder“ und „Computer- / Trainingsanleitung, Bedienung, Biomechanik“.
- Dieses Symbol  weist auf einen Inbusschlüssel hin.
- Dieses Symbol  weist auf einen Drehmomentschlüssel hin.
- Dieses Symbol  weist auf einen Schraubendreher hin.
- Dieses Sportgerät entspricht der DIN EN ISO 20957-1:2014, sowie ...
- DIN EN ISO 20957-6:2017, Genauigkeit HB

2.0 ELEKTRISCHE SICHERHEIT



 WARNUNG! Gefahr durch elektrischen Strom!

Elektrischer Strom bedeutet immer eine potentielle Gefahrenquelle. Handhaben Sie das Gerät stets mit der nötigen Umsicht.

 Setzen Sie das Gerät keiner Feuchtigkeit aus! Schützen Sie es vor Kontakt mit Flüssigkeiten

- Die vorschriftsmäßig installierte Steckdose zum Anschluss des Gerätes muss leicht zugänglich sein.
 - Bevor der Stecker des Netzteiles/Gerätes an die Steckdose angeschlossen wird, muss die auf dem Netzteil/Gerät angegebene Netzspannung mit der örtlichen Netzspannung verglichen werden. Stimmen die Werte nicht überein, wenden Sie sich bitte an unser Serviceteam.
 - Trennen Sie den Netzstecker nach dem Abschalten wieder vom Stromnetz.
 - Achten Sie unbedingt darauf, dass das Netzkabel nicht eingeklemmt oder zur „Stolperfalle“ wird.
 - Verbinden Sie das Netzkabel mit einer Schutzkontakt-Steckdose mit Schutzerdung. Verwenden Sie keine Mehrfachsteckdosen zum Anschluss! Bei Verwendung eines Verlängerungskabels muss dieses den VDE-Richtlinien entsprechen.
 - Das Gerät darf nur mit den mitgelieferten Netzkabel benutzt werden.
-  Ein beschädigtes Netzkabel darf nicht weiter verwendet werden und ist**

sofort auszutauschen. Wenn die Netzleitung beschädigt ist, muss diese vom Hersteller, einem Servicemitarbeiter oder einer anderen qualifizierten Fachperson ersetzt werden, um Gefahren zu vermeiden.

- Dieses Symbol  weist auf Geräte der Schutzklasse I hin.
- Dieses Symbol  weist auf Geräte der Schutzklasse II hin.
- Dieses Symbol  weist auf Geräte der Schutzklasse III hin.

⚠ Ziehen Sie bei allen Reparatur-, Wartungs- und Reinigungsarbeiten unbedingt den Netzstecker!







Important! Please read these instructions carefully before installation and first use. You will receive important information for your safety as well as for the use and maintenance of the appliance. Keep these instructions somewhere safe for information purposes or for maintenance work or ordering replacement parts. Pass these instructions on with the appliance if the owner of the appliance changes.

This symbol  indicates an important warning.

These instructions can also be downloaded at www.kettlersport.com.

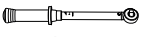
1.0 USER INFORMATION



- **Caution!** Please ensure you observe the instructions in the booklets "Safety Instructions and Instructions for Initial Operation and Maintenance"  and „Computer/training instructions, handling, biomechanics“ .
- This symbol  indicates an Allen key.
- This symbol  indicates a torque wrench.
- This symbol  indicates a screwdriver.
- This sport appliance corresponds to DIN EN ISO 20957-1:2014, and ...
- DIN EN ISO 20957-6:2017, Accuracy HB



• 2.0 ELECTRICAL SAFETY

 **WARNING!** Danger due to electric current!

Electric power is always a potential source of danger. Always use the appliance with the necessary caution.

 Do not expose the appliance to moisture! Protect it from contact with liquids

- The properly installed electrical socket to connect the appliance must be easily accessible.
- Before connecting the plug of the mains adapter/device with the socket, the mains adapter/appliance voltage must be compared to the local voltage. If the values do not match, please contact our service team.
- After switching the appliance off, remove the plug from the power supply again.
- Be very careful in ensuring that the cable does not become trapped or a "tripping hazard".
- Connect the cable with a grounded safety socket. Do not connect via multiple socket strips! When using an extension cable, this must comply with the VDE guidelines.
-  Do not use damaged cables again and exchange them immediately. If the mains line is damaged, this must be replaced by the manufacturer, a member of the service team or another qualified specialist to avoid danger.
- This symbol  indicates that the appliance is protection class I.

- This symbol  indicates that the appliance is protection class II.
- This symbol  indicates that the appliance is protection class III.
- △ The appliance may only be used with the mains adapter provided.





Important ! Veuillez lire attentivement les instructions avant le montage et la première utilisation. Vous y trouverez des conseils importants pour votre sécurité ainsi que pour l'utilisation et la maintenance de l'appareil. Conservez soigneusement ces instructions à titre d'information, pour les travaux de maintenance ou la commande de pièces de rechange. En cas de changement de propriétaire de l'appareil, remettez aussi ces instructions.

Ce symbole  attire l'attention sur un avertissement important.

Ces instructions peuvent également être téléchargées sur www.kettlersport.com.

1.0 INFORMATION UTILISATEUR

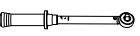
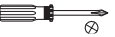
- **Attention !** Suivez aussi impérativement les conseils dans les cahiers „Conseils de sécurité et informations pour l'utilisation de tapis de course“  et „Instructions ayant trait à l'ordinateur / l'entraînement, utilisation, biomécanique“ .
- Ce symbole  attire l'attention sur une clé mâle à six pans.
- Ce symbole  attire l'attention sur une clé de serrage dynamométrique.
- Ce symbole  attire l'attention sur un tournevis.
- Cet appareil de sport répond à la norme DIN EN ISO 20957-1:2014 ainsi que...
- DIN EN ISO 20957-6:2017, précision HB

2.0 SÉCURITÉ ÉLECTRIQUE



 **AVERTISSEMENT !** Danger dû au courant électrique !

Le courant électrique est toujours synonyme de source potentielle de danger. Manipulez toujours l'appareil avec la circonspection nécessaire.

 N'exposez pas l'appareil à l'humidité ! Protégez-le contre tout contact avec des liquides

- La prise de courant installée comme il se doit pour connecter l'appareil doit être facilement accessible.
- Avant que la prise mâle du bloc d'alimentation/de l'appareil ne soit raccordée à la prise femelle, comparer la tension de secteur indiquée sur le bloc d'alimentation/l'appareil avec la tension de secteur locale. Si les valeurs ne correspondent pas, veuillez vous adresser à notre équipe du service.
- Débranchez de nouveau la prise mâle après la mise à l'arrêt.
- Veuillez impérativement à ce que le câble d'alimentation ne soit pas coincé et ne risque pas de faire chuter.
- Raccordez le câble d'alimentation à une prise de courant de sécurité.

N'utilisez pas de blocs multiprises pour le raccord ! En cas d'utilisation d'une rallonge électrique, celle-ci doit répondre aux directives VDE.

- N'utilisez l'appareil qu'avec le câble d'alimentation fourni.
- △ Ne continuez pas d'utiliser un câble d'alimentation endommagé et échangez-le immédiatement. Si la ligne de secteur est endommagée, celle-ci devra être remplacée par le fabricant, un collaborateur du service après-vente ou une autre personne qualifiée pour éviter tout danger.
- Ce symbole  indique les appareils de la classe de protection I.
- Ce symbole  indique les appareils de la classe de protection II.
- Ce symbole  indique les appareils de la classe de protection III.
- △ Débranchez impérativement la fiche d'alimentation pour tous les travaux de réparation, de maintenance et de nettoyage !

LIEFERUMFANG

- EN SCOPE OF DELIVERY
- FR FOURNITURES

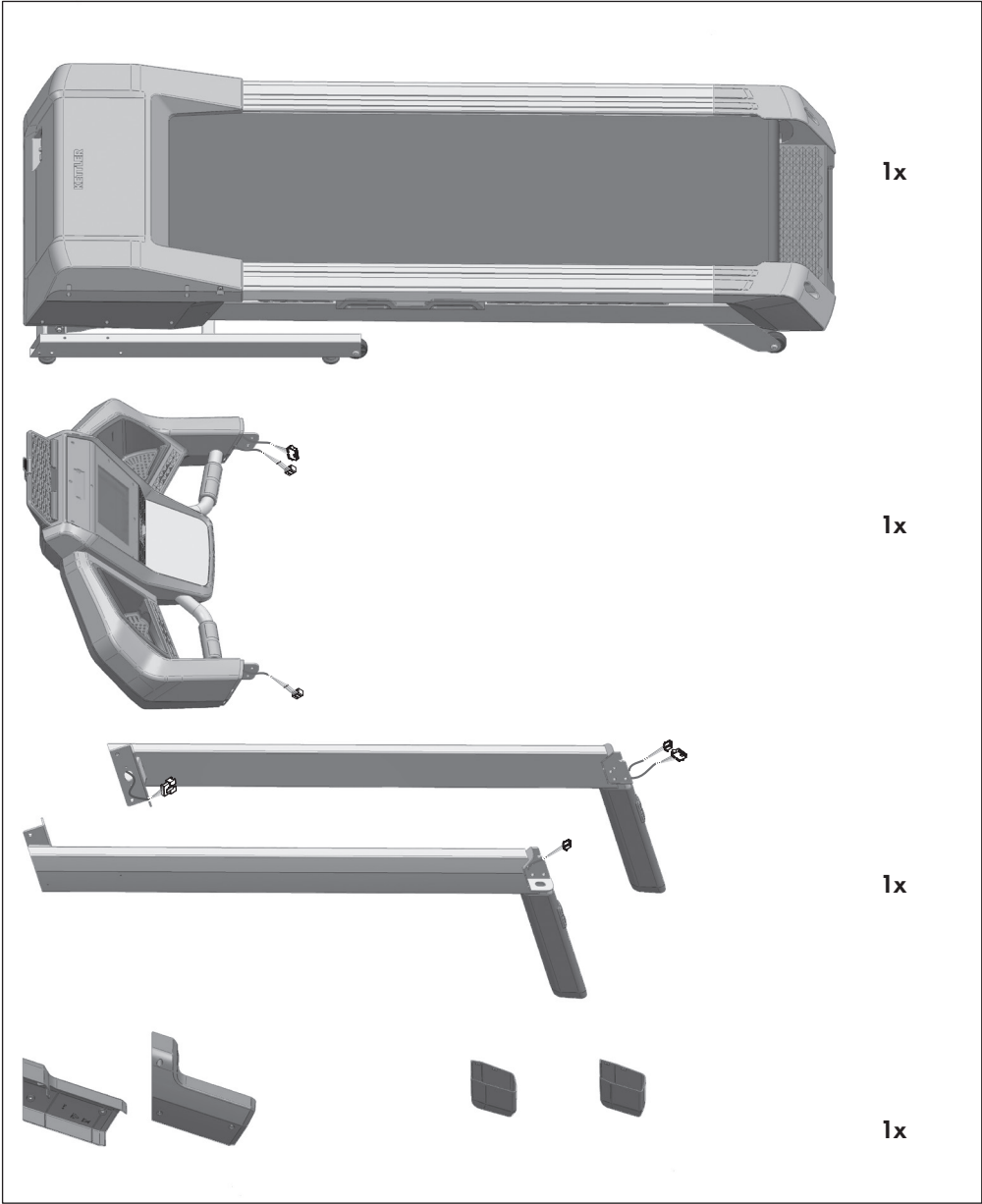

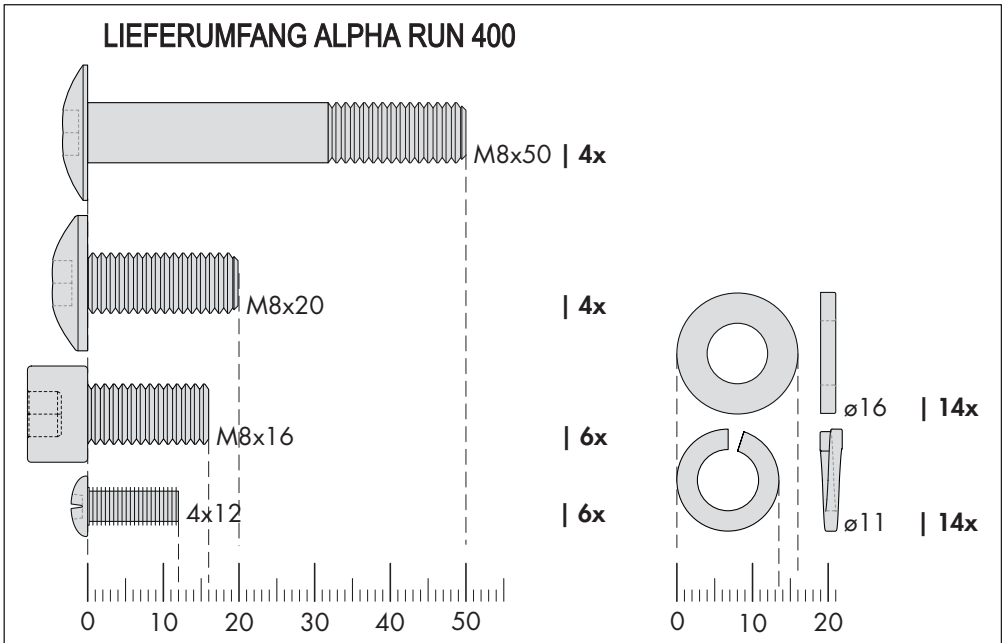
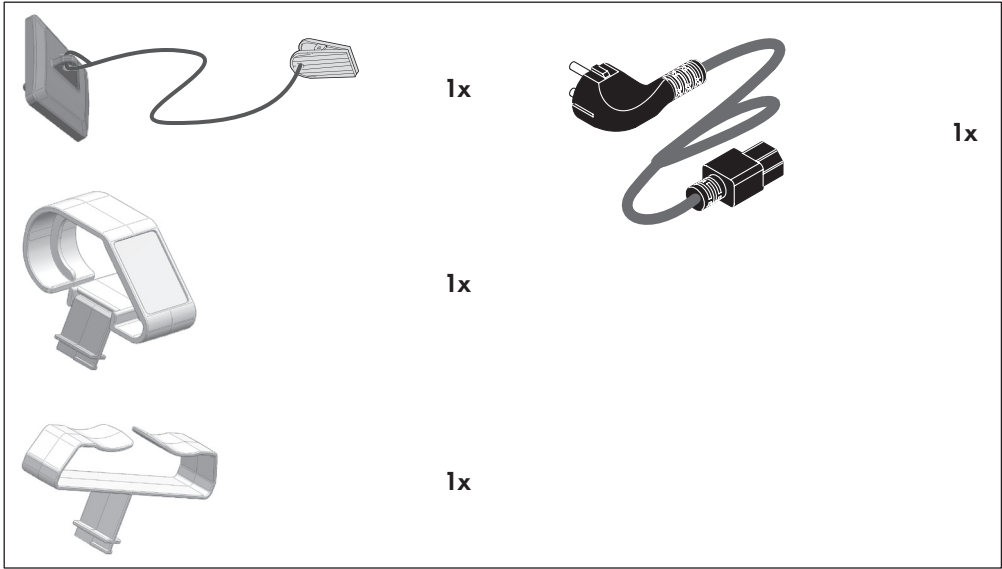

LIEFERUMFANG ALPHA RUN 200

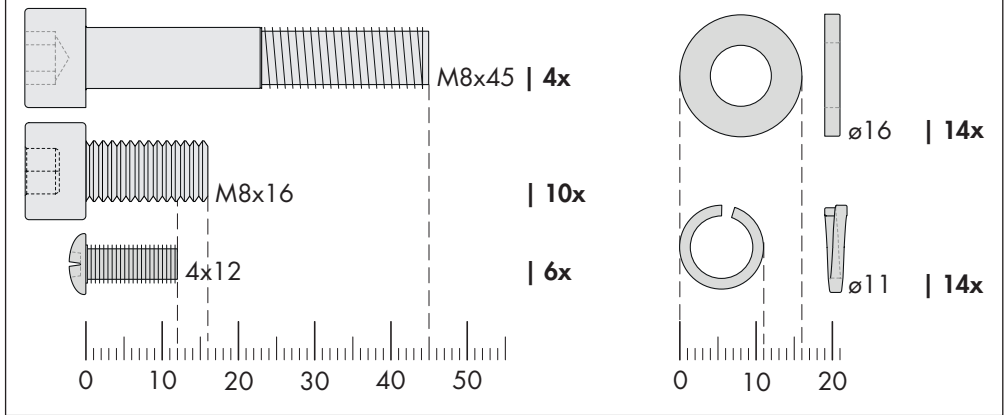

DE Benötigtes Werkzeug – Gehört nicht zum Lieferumfang.

EN Tools required – Not included.

FR Outils nécessaires – Ne fait pas partie du domaine de livraison.

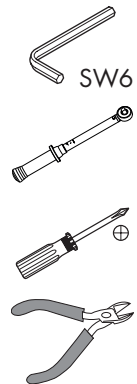

1.

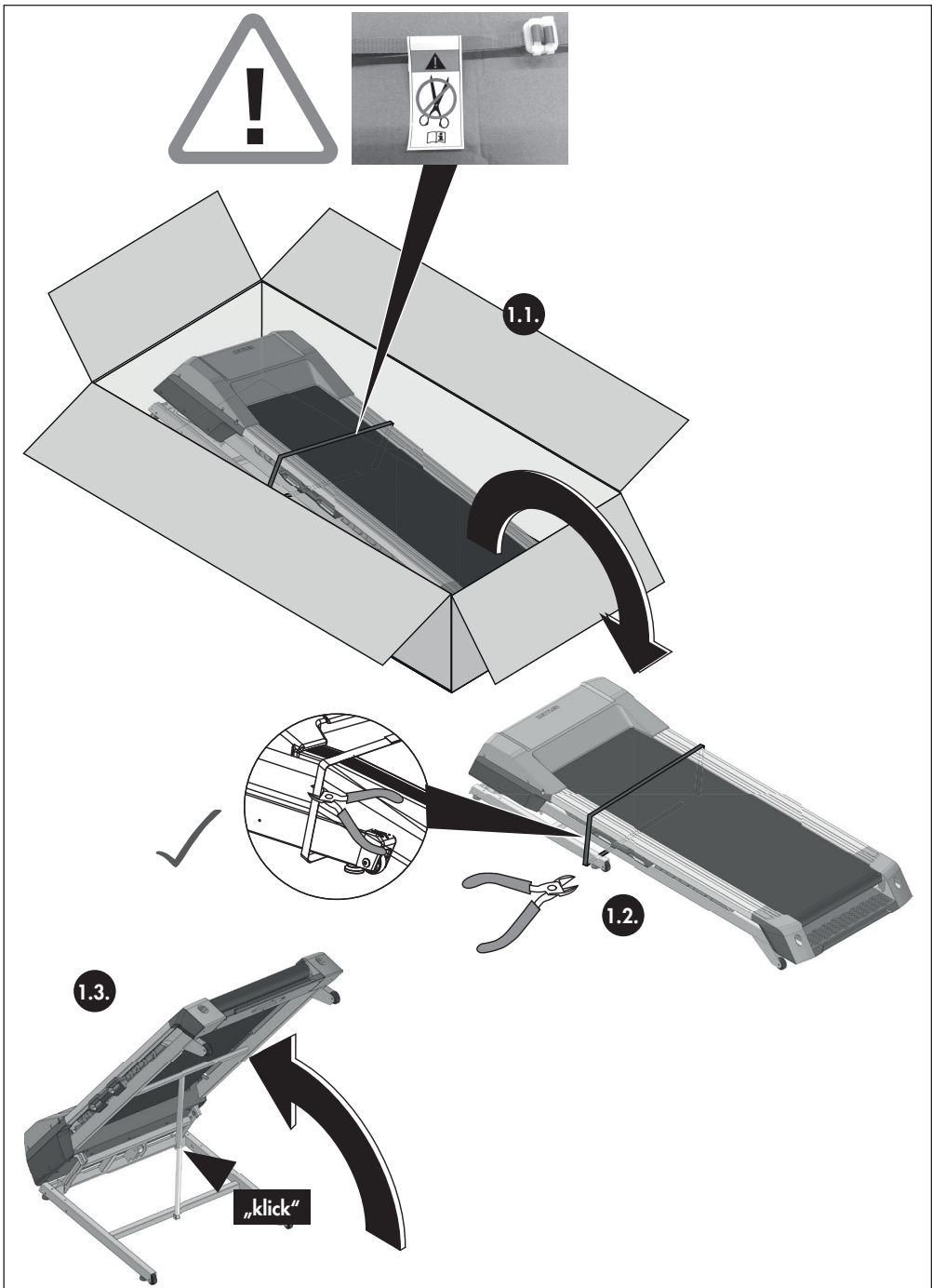

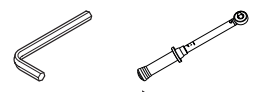
2.	ALPHA RUN 200	2.3.		
	4x M8x16 ø11 ø16			SW 6 $\vec{M} = 20 \text{ Nm}$

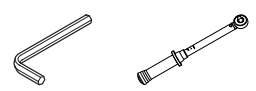
2.	ALPHA RUN 400	2.3.		
	4x M8x20 ø13,5 ø17			SW 6 $\vec{M} = 20 \text{ Nm}$

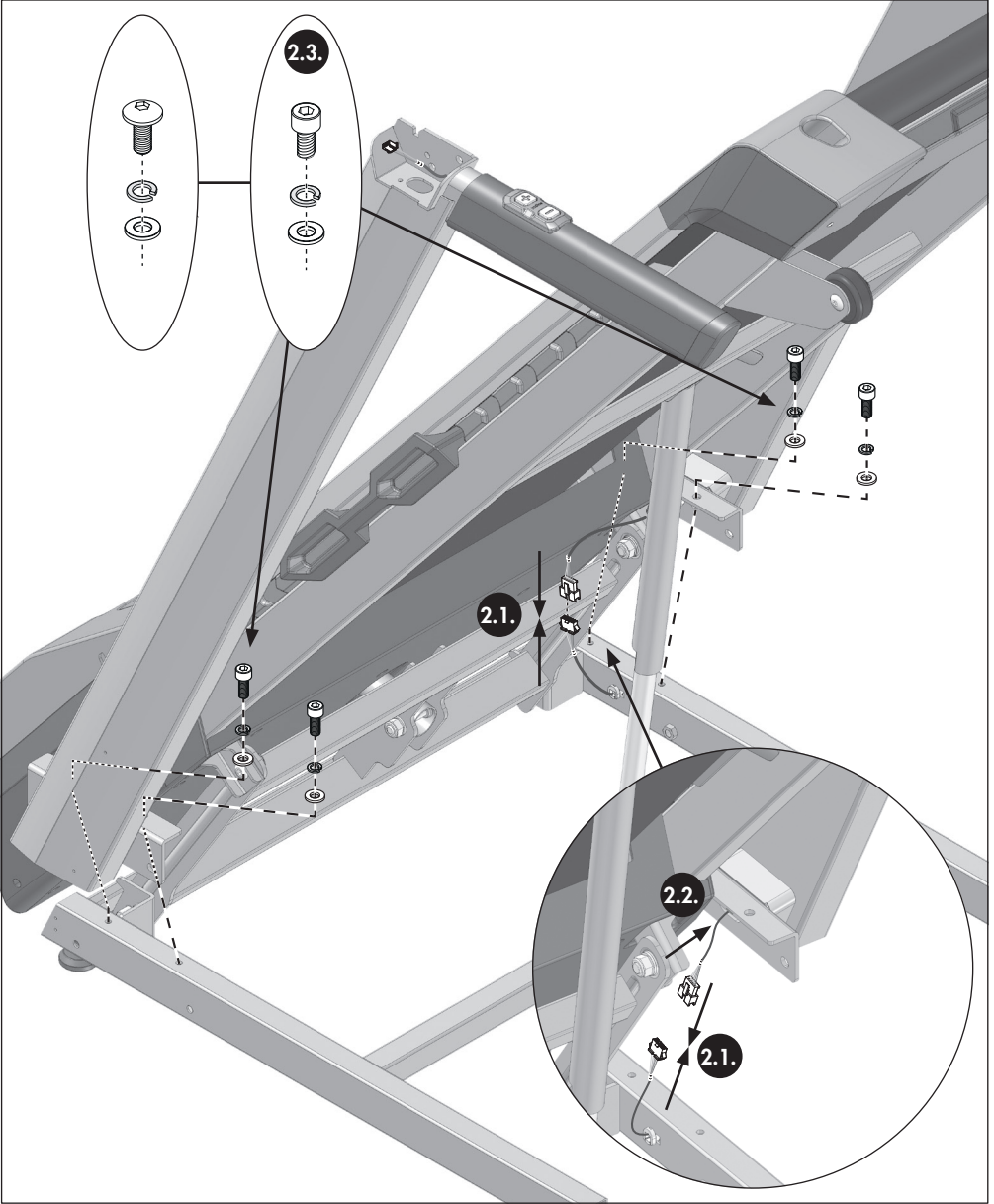

3.

ALPHA RUN 200

3.2. 
4x | M8x45 ø13,5 ø17

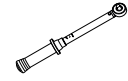

SW 6

$\vec{M} = 20 \text{ Nm}$

3.

ALPHA RUN 400

3.2. 
4x | M8x50 ø13,5 ø17

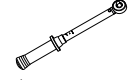

SW 6

$\vec{M} = 20 \text{ Nm}$

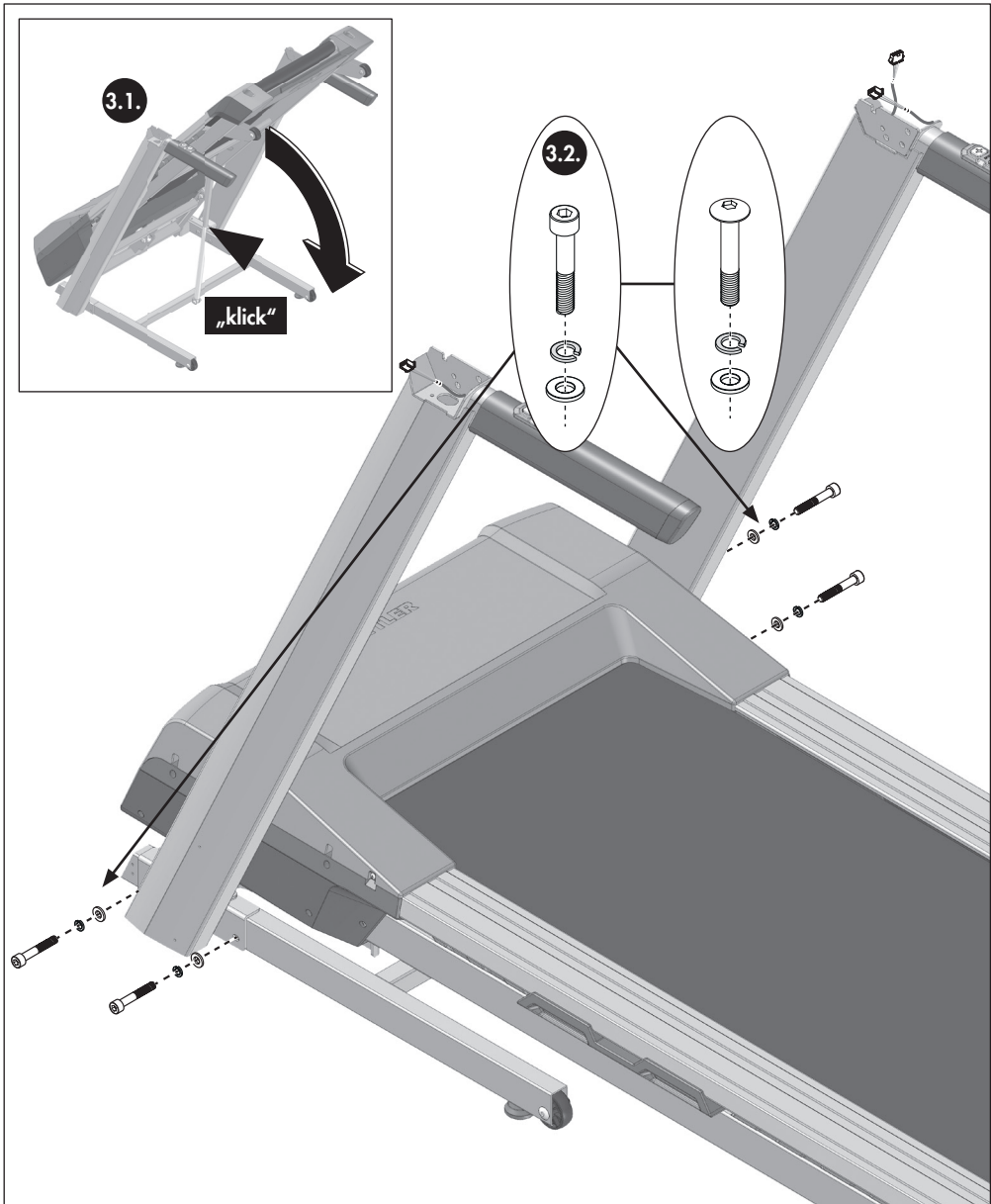

4.1.

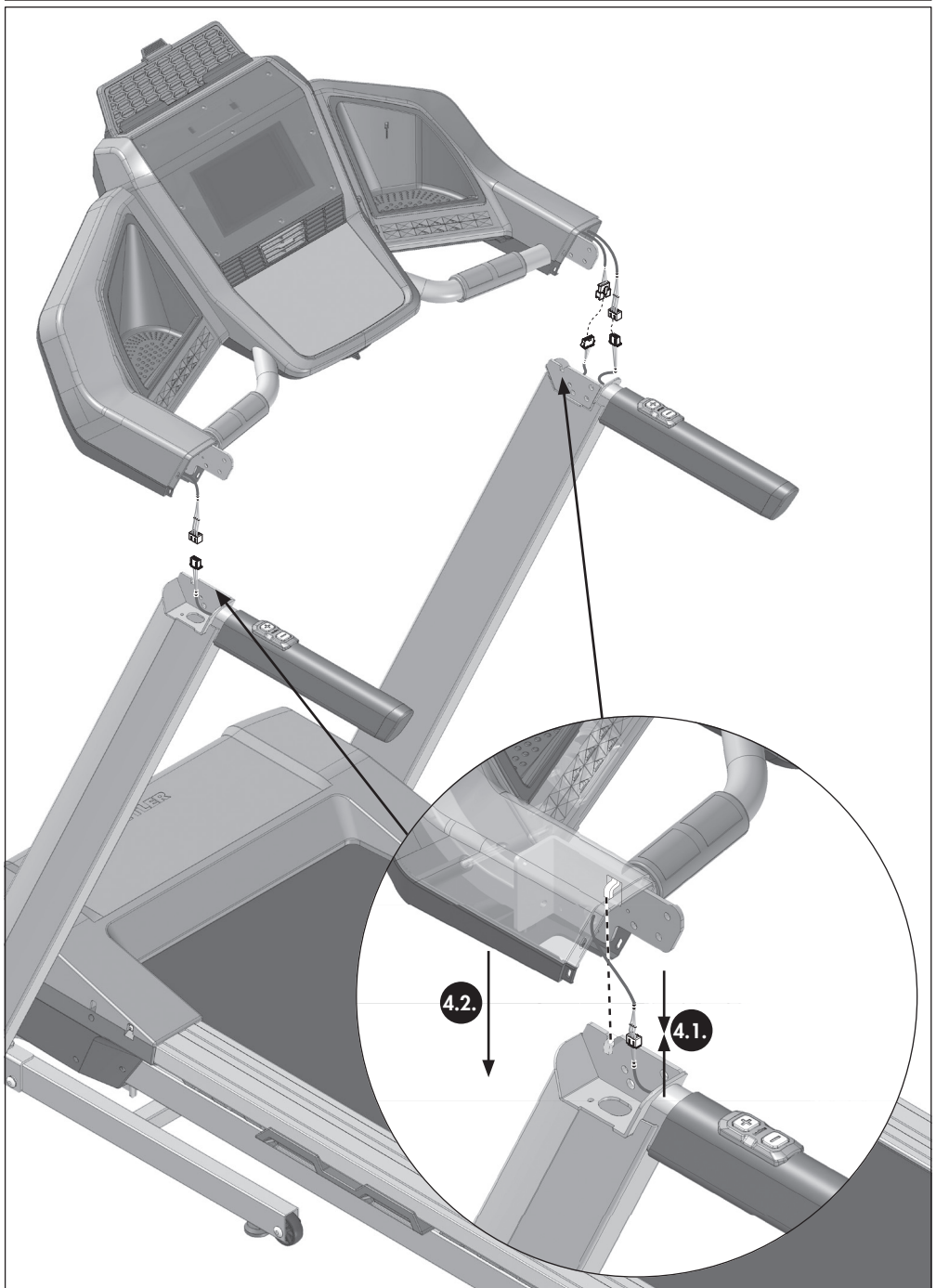

4.3.

4.3.   
6x | M8x16 ø13,5 ø17

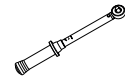

SW 6

$\vec{M} = 20 \text{ Nm}$

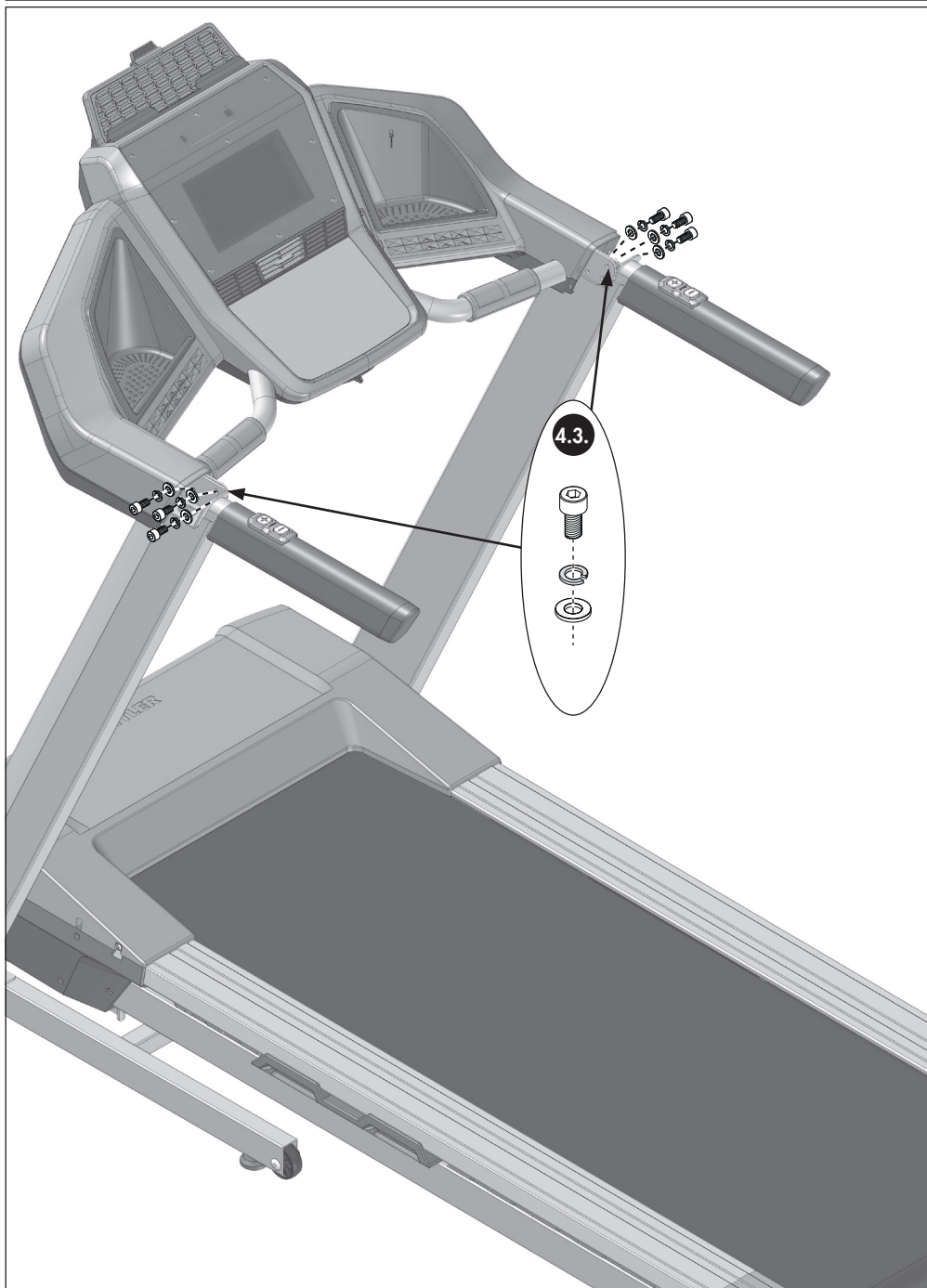

5.



6.

6.1. 

6x | 4x12

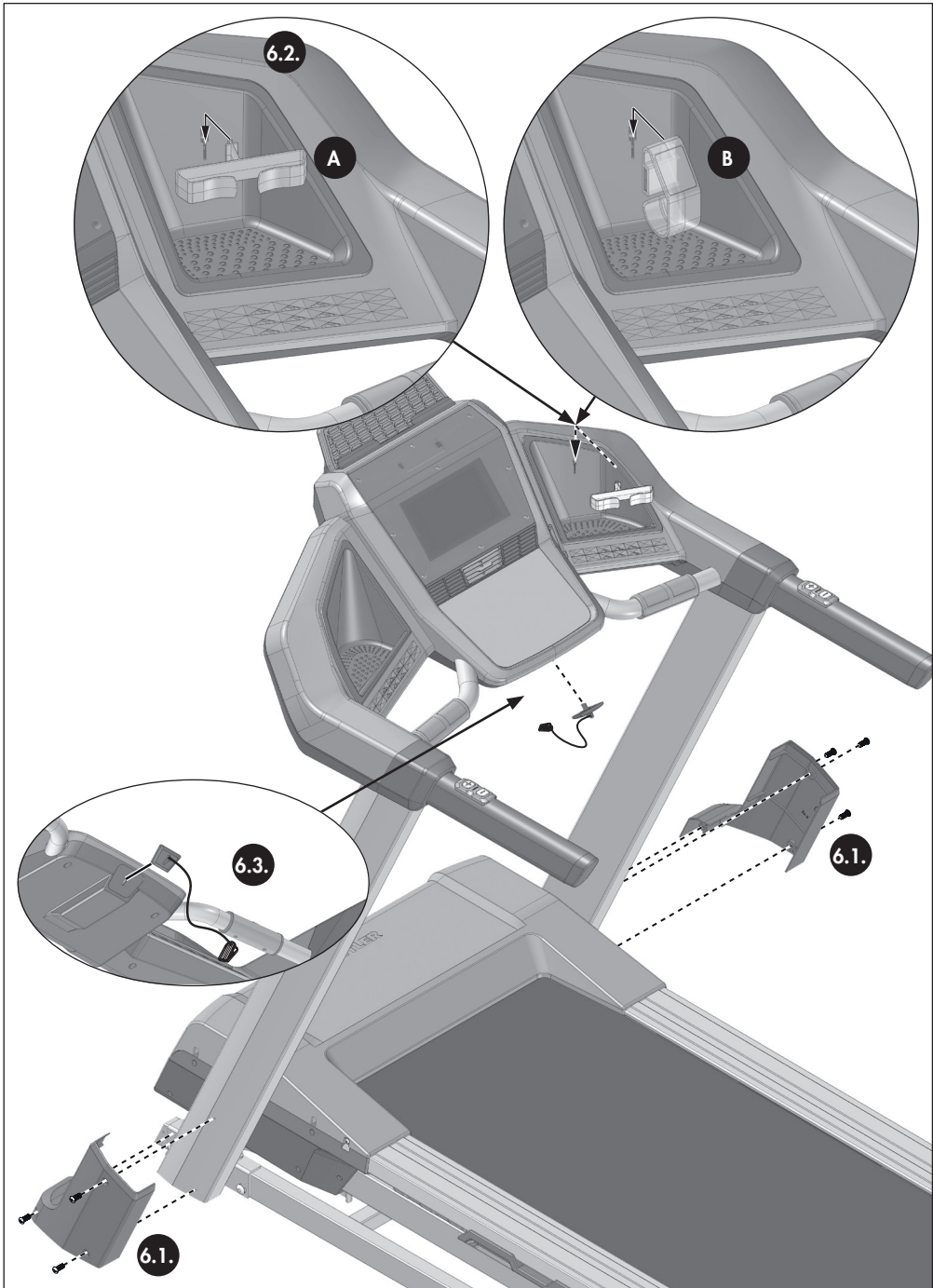
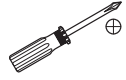

TYPENSCHILD

- DE** Beispiel Typenschild - Seriennummer
- EN** Example Type label - Serial number
- FR** Exemple Plaque signalétique - Numéro de serie

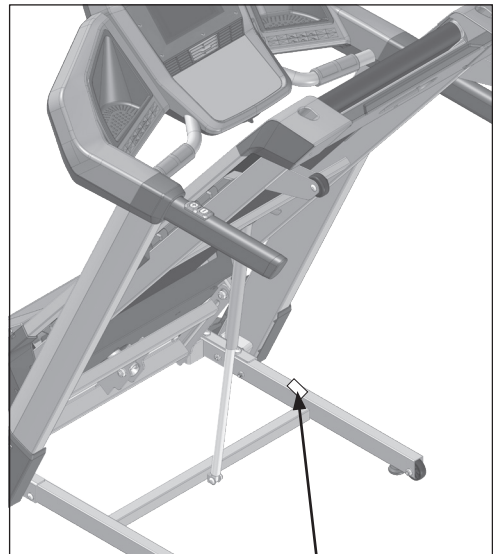

TRISPORT AG
Boesch 67
CH 6331 Huenenberg

A/N #####-###
S/N ##### #####

DIN EN ISO 20957-1:2014
DIN EN ISO 20957-8:2017, XX



max. ### kg
Made in PRC



ERSATZ / BAUTEILBESTELLUNG TM 1037-100 ALPHA RUN 200

TM1037-100 ALPHA RUN 200			TM1037-100 ALPHA RUN 200		
①	1x	68008835	③③	1x	68008865
②	1x	68008836	③④	1x	68008866
③	1x	68008837	③⑤	1x	68001786
④	1x	68008838 X	③⑥	1x	68008867
⑤	1x	68008839	③⑦	1x	68008868
⑥	1x	68008840	③⑧	1x	68008869
⑦	1x	68008841	③⑨	1x	68008870
⑧	1x	68008842	④⑩	1x	68008871
⑨	1x	68008843	④①	1x	68008872
⑩	1x	68008844	④②	1x	68008873
⑪	1x	68001760	④③	1x	68001723
⑫	1x	68001761	④④	1x	68001724
⑬	1x	68008845 X	④⑤	1x	68008874
⑭	1x	68008846	④⑥	1x	68001728 X
⑮	1x	68008847 X	④⑦	1x	68008875
⑯	1x	68008848 X	④⑧	1x	68008876
⑰	1x	68008849 X	④⑨	1x	68008877
⑱	1x	68008850	⑤⑩	1x	68008878
⑲	1x	68008851	⑤①	1x	68008879
⑳	1x	68008852	⑤②	1x	68008880 X
㉑	1x	68008853 X	⑤③	1x	68008881
㉒	1x	68008854	⑤④	1x	68008882
㉓	1x	68008855	⑤⑤	1x	68001735
㉔	1x	68008856	⑤⑥	1x	68001736
㉕	1x	68008857	⑤⑦	1x	68001737
㉖	1x	68008858	⑤⑧	1x	68008883 X
㉗	1x	68008859	⑤⑨	1x	68008884
㉘	1x	68008860	⑥⑩	1x	68008885
㉙	1x	68008861	⑥①	1x	68001741
⑳	1x	68008862	⑥②	1x	68008886
㉑	1x	68008863 X			
㉒	1x	68008864			

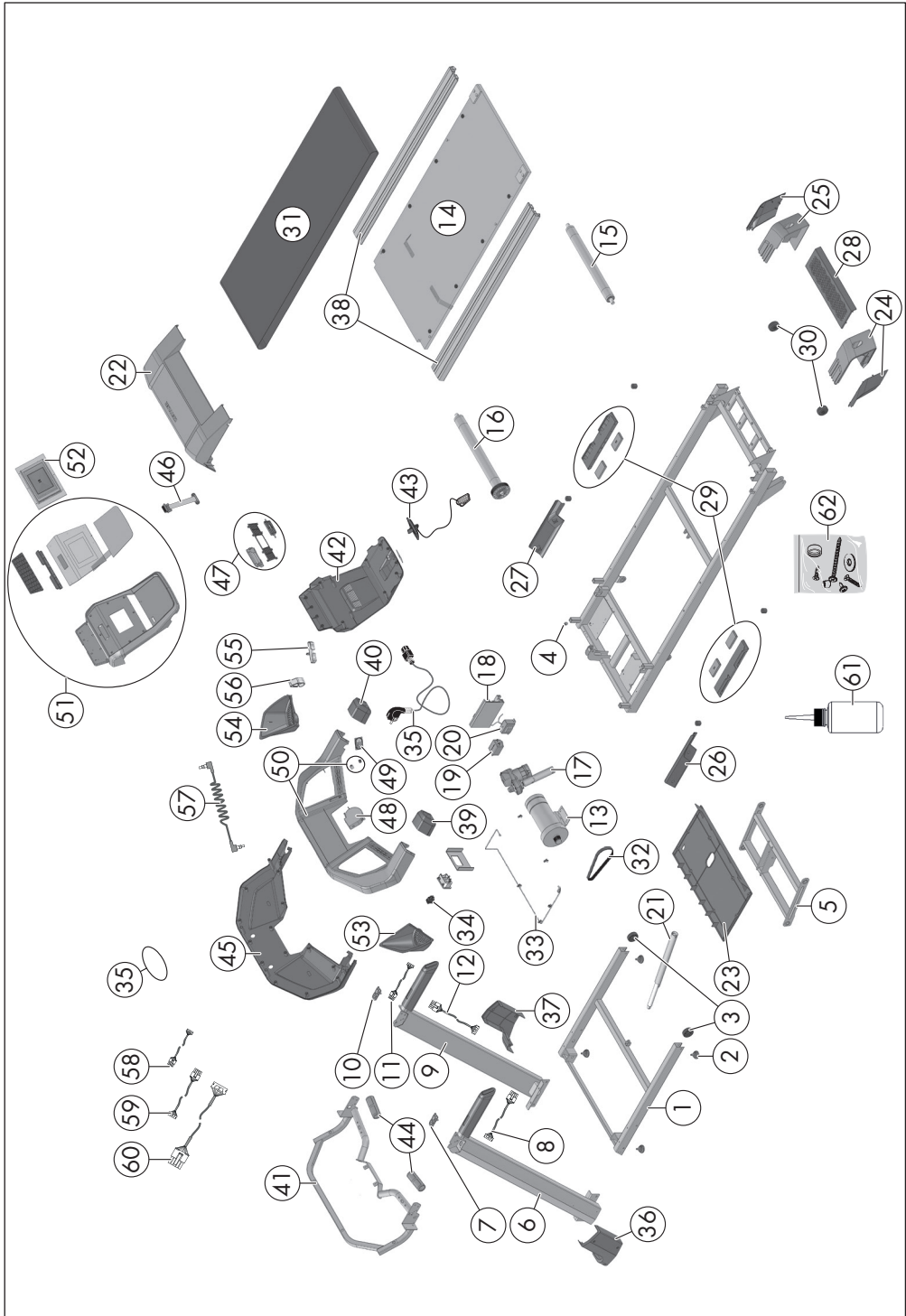

ERSATZ / BAUTEILBESTELLUNG TM1038-100 ALPHA RUN 400

		TM1038-100 ALPHA RUN 400			TM1038-100 ALPHA RUN 400
①	1x	68001680	③③	1x	68001712 X
②	1x	68001681	③④	1x	68001713
③	1x	68001682	③⑤	1x	68001714 X
④	1x	68001683 X	③⑥	1x	68001715
⑤	1x	68001684	③⑦	1x	68001716
⑥	1x	68001685	③⑧	1x	68001717
⑦	1x	68001686	③⑨	1x	68001718
⑧	1x	68001687	④⑩	1x	68001719
⑨	1x	68001688	④①	1x	68001720
⑩	1x	68001689	④②	1x	68001721
⑪	1x	68001690	④③	1x	68001722
⑫	1x	68001691 X	④④	1x	68001723
⑬	1x	68001692	④⑤	1x	68001724
⑭	1x	68001693	④⑥	1x	68001725
⑮	1x	68001694	④⑦	1x	68001726
⑯	1x	68001695	④⑧	1x	68001727
⑰	1x	68001696 X	④⑨	1x	68668876
⑱	1x	68001697	⑤⑩	1x	68001729 X
⑲	1x	68001698	⑤①	1x	68001730
⑳	1x	68001699	⑤②	1x	68001731
㉑	1x	68001700	⑤③	1x	68001732 X
㉒	1x	68001701	⑤④	1x	68001733
㉓	1x	68001702	⑤⑤	1x	68001734
㉔	1x	68001703	⑤⑥	1x	68001735
㉕	1x	68001704	⑤⑦	1x	68001736
㉖	1x	68001705	⑤⑧	1x	68001737
㉗	1x	68001706	⑤⑨	1x	68001738
㉘	1x	68001707	⑥⑩	1x	68001739 X
㉙	1x	68001708	⑥①	1x	68001740
⑳	1x	68001709 X	⑥②	1x	68001741
㉑	1x	68001710	⑥③	1x	68001742
㉒	1x	* 68001711			

