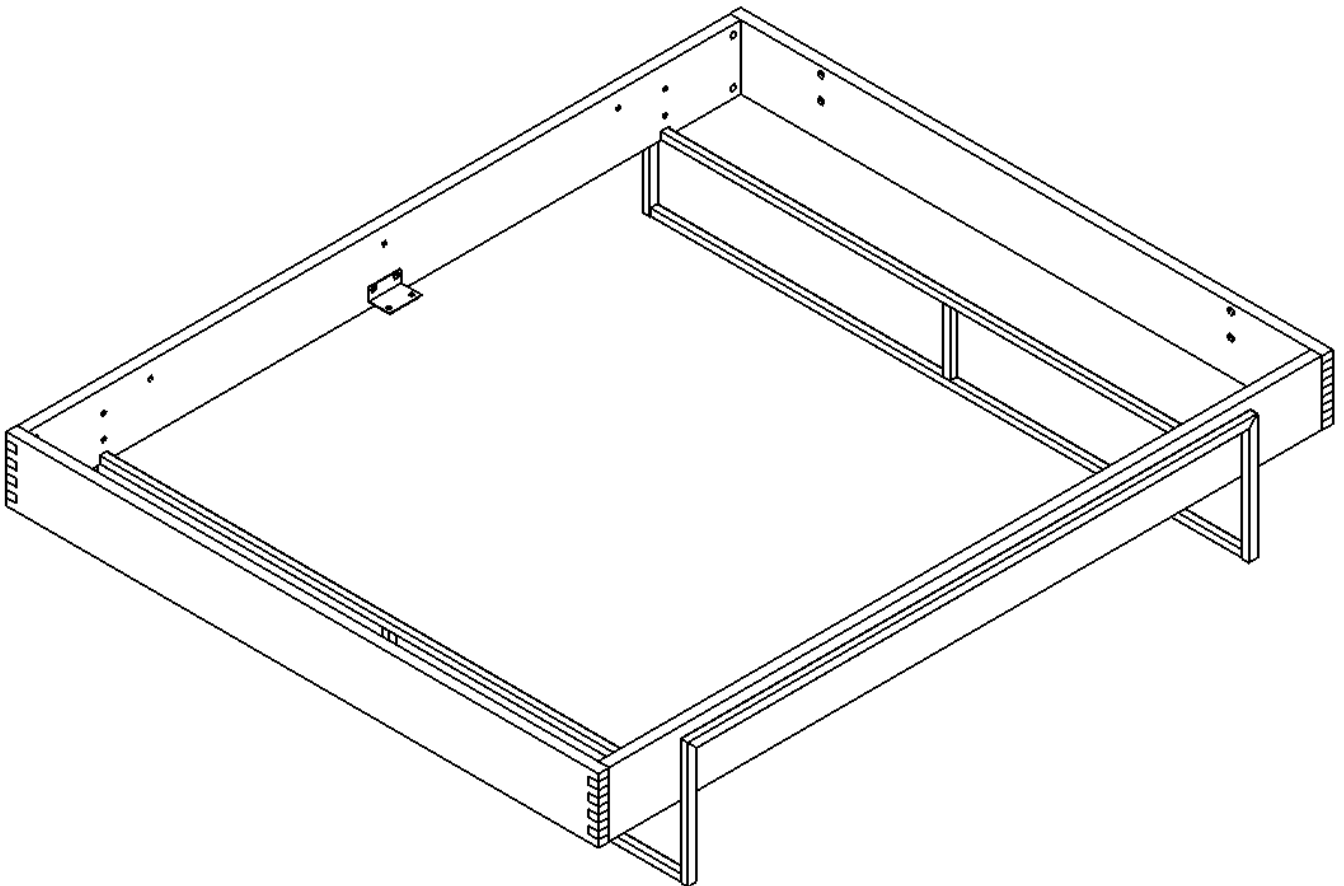

Wichtig:
Vor Gebrauch sorg-
fältig durchlesen/
Montageanleitung für
späteres Nachlesen
aufbewahren

Important:
Lisez attentivement/
conserver les instruc-
tions d'installation
pour référence future
avant utilisation

Importante:
lettura/conservare
Istruzioni per l'installa-
zione per riferimento
futuro accuratamente
prima dell'uso

Important:
Read carefully before
assembling/keep and
store Instruction for
reference

DON





Warnhinweise

Bestimmungsgemässer Gebrauch: Bitte achten Sie darauf, dass Ihre Möbel nur Ihrem Zweck gemäss verwendet werden. Für eine dauerhafte Funktionsfähigkeit ist eine sachgerechte Nutzung und regelmässige Unterhaltungspflege sehr wichtig.

Mises en garde

Utilisation conforme: Veuillez vous assurer que vos meubles sont utilisés uniquement pour leur usage prévu. Un entretien régulier et une utilisation conforme sont essentiels pour assurer un fonctionnement durable.

Avvertenze

Utilizzo per lo scopo previsto: assicuratevi che i vostri mobili siano utilizzati solo per lo scopo per cui sono stati realizzati. Per garantire il loro funzionamento nel tempo è importante utilizzarli correttamente e sottoporli regolarmente a cure manutentive.

Warning notice

Intended use: Please make sure that you only use your furniture for the purpose it was designed for. Correct use and regular maintenance are essential for ensuring your furniture remains in working order for the long-term.

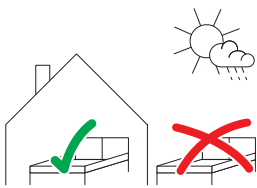

Anwendung: Das von Ihnen erworbene Bett eignet sich für den allgemeinen, privaten Wohnbereich. Es ist nicht für den Nass-, Aussen- oder gewerblichen Bereich geeignet.

Usage: Le lit que vous avez acheté convient pour l'habitat privé en général. Il ne convient pas pour l'extérieur, les milieux humides ou le domaine commercial.

Impiego: il letto acquistato è adatto per essere utilizzato in generale, in ambito domestico. Non è adatto per gli esterni, per l'esposizione alla pioggia o per ambienti commerciali.

Area of use: The bed you have purchased is suitable for use in general private living quarters. It is not suitable for areas that are wet, outside or used for commercial purposes.



WARNUNG
Verschluck- und Erstickungsgefahr: Kleinteile und Verpackungsmaterial können verschluckt werden.

AVERTISSEMENT
Risque d'ingestion et d'étouffement: Les petites pièces et le matériel d'emballage peuvent être avalés.

AVVERTENZA
Pericolo di ingestione e soffocamento: piccole parti e materiale di imballaggio possono essere ingerite.

WARNING
Risk of swallowing and choking: Small parts and packaging material may be swallowed.



WARNUNG! Tüten und Folien sind kein Spielzeug! Bitte von Babys und Kleinkindern fernhalten! Nicht über den Kopf ziehen; Erstickungsgefahr!

AVERTISSEMENT! Les sacs et films ne sont pas des jouets! Veuillez les tenir hors de portée des bébés et jeunes enfants! Ne pas mettre sur la tête, risque d'étouffement!

AVVERTENZA! Sacchetti e pellicole non sono un giocattolo! Tenere lontano dalla portata dei neonati e dei bambini piccoli! Non metterli in testa, pericolo di soffocamento!

WARNING! Bags and film coverings are not toys! Please keep away from babies and small children! Do not put them over your head, risk of suffocation!



VORSICHT,
Verletzungsgefahr: Kleinkinder dürfen sich nicht im Montage-Bereich aufhalten und an Möbeln hochziehen oder hinaufklettern.

PRÉCAUTION,
risque de blessures: Les jeunes enfants ne peuvent pas se tenir dans la zone de montage ni tirer ou grimper sur des meubles.

PRECAUZIONE,
pericolo di lesioni: tenere i bambini lontano dal luogo di montaggio e evitare che si appendano o arrampichino sul mobile.

PRECAUTION,
risk of injury: Small children must keep away from the assembly area. They must refrain from climbing up on the furniture.



Altersfreigabe: Nicht für Kinder unter drei Jahren geeignet.

Age minimum: Ne convient pour les enfants de moins de trois ans.

Limite di età: non adatto per bambini sotto i tre anni.

Age restriction: Not suitable for children under three.

1.

Allgemeine Hinweise

Remarques générales

Avvertenze generali

General information

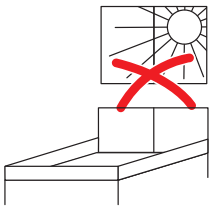

ACHTUNG
Direkte Sonneneinstrahlung:
Führt zu Farbveränderungen.

ATTENTION
Exposition directe au soleil:
Provoque des décolorations.

ATTENZIONE
Irraggiamento diretto del sole:
ne modifica il colore.

ATTENTION
Direct sunlight:
results in discolouration.

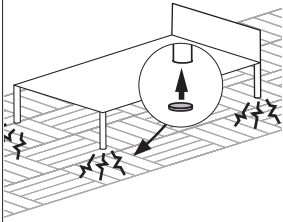

Schutzgleiter:
Mit Schutzgleitern (z.B. aus Filz), lassen sich Schäden auf kratzem-pfindlichen Böden (z.B. Parkett) vermeiden.

Patins:
Les patins (p.ex. en feutre) permettent d'éviter d'endommager les sols sensibles aux rayures (p.ex. parquet).

Scivolante protettivo:
grazie agli scivolanti protettivi (ad es. feltro) si evita di danneggiare pavimenti sensibili ai graffi (ad es. parquet).

Protective covers:
Protective covers, e.g. felt pads, prevent damage to floors that are easily scratched (e.g. parquet).

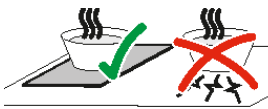

ACHTUNG,
Temperatur:
Nie heiße oder sehr kalte Objekte direkt auf die Oberfläche stellen. Geeigneten Schutz verwenden, z.B. Untersteller.

ATTENTION,
température:
Ne jamais poser des objets chauds ou très froids directement sur la surface. Utiliser une protection appropriée, p.ex. sous-plat.

ATTENZIONE,
temperatura:
non appoggiare mai oggetti caldi o molto freddi direttamente sulla superficie. Utilizzare una protezione adatta, ad es. un sotto piatto.

ATTENTION,
temperature:
Do not place hot or cold objects directly on the surface. Use the appropriate protection, e.g. saucer.

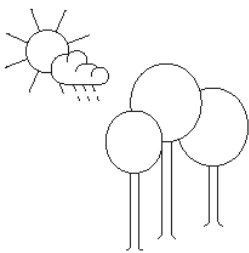

Holzprodukte:
Holz ist ein natürlicher Rohstoff. Jeder Baum ist abhängig vom Standort verschiedensten Einflüssen, wie Klima etc., ausgesetzt. Durch diese Einflüsse wird das Erscheinungsbild (Farbe, Äste, Maserung etc.) des Holzes massgeblich beeinflusst. Abhängig von der Luftfeuchtigkeit und Temperatur, hat Holz die Eigenschaft, sich auszudehnen und kleiner zu werden. Dies kann zu Rissen führen. Veränderungen und Naturmerkmale sind natürlich und dadurch ist jedes Massivholz-möbelstück ein Unikat.

Produits en bois:
Le bois est une matière naturelle. Chaque arbre est exposé à diverses influences, comme le climat etc., en fonction de son lieu de plantation. L'aspect du bois (teinte, nœuds, grain etc.) est fortement conditionné par ces influences. Le bois a la propriété de se dilater ou de se rétracter en fonction de l'humidité et de la température. Cela peut provoquer des fissures.

Prodotti di legno:
il legno è una materia prima naturale. Ogni albero, a seconda del luogo in cui cresce, è esposto a diverse influenze come il clima, ecc. Grazie a questi agenti, l'aspetto (colore, rami, venatura, ecc.) del legno viene fortemente influenzato. A seconda dell'umidità dell'aria e della temperatura, il legno ha la capacità di espandersi e ritirarsi. Questo può portare alla formazione di crepe.

Wooden products:
Wood is a natural raw material. Each tree is subjected to a whole variety of influences, e.g. the climate, depending on its location. These influences are decisive in creating the way the wood ultimately looks (colour, knots, grain, etc.). Depending on the humidity and temperature, wood is capable of expanding and contracting. As a result cracks may form.

Ces caractéristiques naturelles et les changements sont normaux, ce qui fait de chaque meuble en bois une pièce unique.

La trasformazione e le caratteristiche sono naturali e, pertanto, ogni mobile di legno massiccio è unico nel suo genere.

Changes and natural characteristics are natural, so each piece of solid wood furniture completely unique.

1.

Allgemeine
Hinweise

Remarques
générales

Avvertenze
generali

General
information

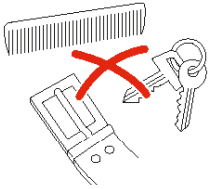

ACHTUNG
Leder/Stoff:
Schützen Sie das
Leder/den Stoff vor
scharfen Gegen-
ständen (Schlüssel,
Gurtschnallen, etc.).

ATTENTION
Cuir/tissu:
Protégez le cuir/tissu
des objets coupants
(clés, boucles de cein-
ture etc.)

ATTENZIONE
Pelle/tessuto:
proteggere la pelle/il
tessuto da oggetti ta-
glianti (chiavi, fibbie,
ecc.)

ATTENTION
Leather/fabric:
Protect the leather/
fabric against sharp
objects (e.g. keys, belt
buckles, etc.)

ACHTUNG Jeans:
Jeans-Produkte kön-
nen auf hellen Überzü-
gen zu Verfärbungen
führen.

ATTENTION jeans:
les tissus en jean
peuvent altérer la cou-
leur des revêtements
clairs.

ATTENZIONE jeans:
sui rivestimenti chiari il
tessuto jeans può cau-
sare un'alterazione del
colore.

CAUTION Jeans:
Jeans products can
discolour light cover
fabrics.

Bei bestehenden
Lattenrosten und
Matratzen:
Bitte prüfen sie bei
bestehenden Latten-
rosten und Matratzen,
ob die Auflagen genü-
gen und Verstellungen
einwandfrei funkti-
onieren. Bei Fragen
wenden Sie sich bitte
an den micasa-Kun-
dendienst in Ihrem
Möbelhaus.

En présence de lattes
et matelas:
assurez-vous que les
lattes et les matelas du
produit offrent un sup-
port adapté, et que les
outils de réglage sont
parfaitement fonction-
nels. Pour toute ques-
tion, adressez-vous au
service client de votre
magasin de meubles
micasa

In caso di doghe e ma-
terassi già esistenti:
verificare che le doghe
e i materassi offrano
un supporto adegua-
to e che i regolatori
siano perfettamente
funzionanti. In caso di
domande potete rivol-
gervi al servizio clienti
del vostro negozio di
mobili micasa.

Slatted beds, and mat-
tresses:
Please check your slat-
ted bed and mattress,
for adequate support
and fully functioning
adjusters. If in doubt
please contact micasa
Customer Service at
your furniture store.

Unikat:
Dieses Produkt wurde
von Hand hergestellt
und jedes Stück ist
einzigartig.

Pièce unique:
Ce produit a été réali-
sé à la main et chaque
pièce est unique.

Esemplare unico:
questo prodotto è sta-
to realizzato a mano e
ogni esemplare è un
pezzo unico.

Unique:
This product has been
made by hand and
therefore each piece is
unique.

2.

Montagehinweise

Instructions de montage

Istruzioni di montaggio

Assembly information

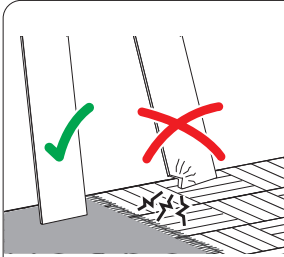

Montageschäden:

Vermeiden Sie, indem Sie einen sauberen und weichen Untergrund verwenden (z.B. Teppich). Teile beim Auspacken oder während der Montage nur auf weiche Unterlagen legen/stellen. Darauf achten, dass grössere Teile nicht kippen können.

Domages au montage:

Évitez les dommages en utilisant un fond propre et doux (p.ex. tapis). Lors du déballage et montage, posez/placez les éléments uniquement sur un fond doux. Assurez-vous que les grands éléments ne peuvent pas basculer.

Danni in fase di montaggio:

evitare di causare danni utilizzando una base pulita e morbida (ad es. tappeto). Nella fase di disimballaggio e durante il montaggio, appoggiare i pezzi esclusivamente su una base morbida. Fare attenzione che i pezzi più grandi non si ribaltino.

Damages during assembly:

These can be avoided if you use a clean soft surface (e.g. carpet). Only place parts on a soft surface when unpacking or during the assembly. Make sure that larger parts cannot tip over.



Personen:
Für die Montage erforderliche Anzahl Personen.

Personnes:
Nombre de personnes nécessaires au montage.

Persone:
numero di persone necessarie per il montaggio.

People:
Number of people required for the assembly.



Montagerichtzeit:

Ungefähre Zeit in Stunden.

Durée indicative du montage:

Durée approximative en heures.

Tempo di montaggio:

tempo in ore approssimativo.

Assembly time:

Approximate time in hours.









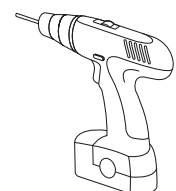
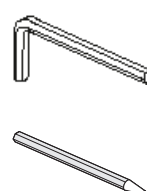
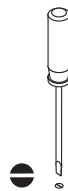
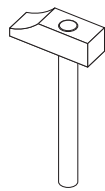
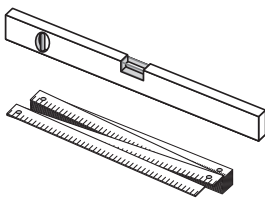





Benötigtes Werkzeug:

Outils nécessaires:

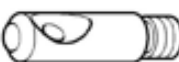
Attrezzi necessari:

Tools required:



<p>6210 Don</p>  <p>1607200</p>	 <p>A 166x18x3</p>	 <p>B 186x18x3</p>	 <p>C 166x22x2</p>	 <p>D 186x22x2</p>	 <p>E 200x18x3</p>	 <p>F 914/3.6</p>	 <p>G D16x19</p>	 <p>H M10</p>	 <p>I D10x20</p>	 <p>J M6x10</p>	 <p>K M8x16</p>	 <p>L Gr4</p>	 <p>M Gr5</p>	<p>P 1/2 P 2/2</p>  <p>1607200</p>	<p>2 x 166</p>	<p>2 x 166</p>	<p>2x</p>	<p>2x</p>	<p>8x</p>	<p>8x</p>	<p>16x</p>	<p>4x</p>	<p>1x</p>	<p>1x</p>	<p>1x</p>
<p>P 1/2 P 2/2</p>  <p>1607200</p>	<p>2 x 186</p>	<p>2 x 186</p>	<p>2x</p>	<p>2x</p>	<p>8x</p>	<p>8x</p>	<p>16x</p>	<p>4x</p>	<p>1x</p>	<p>1x</p>	<p>1x</p>														

3.

Montage-
anleitung

Instructions de
montage

Istruzioni per
il montaggio

Assembling in-
struction

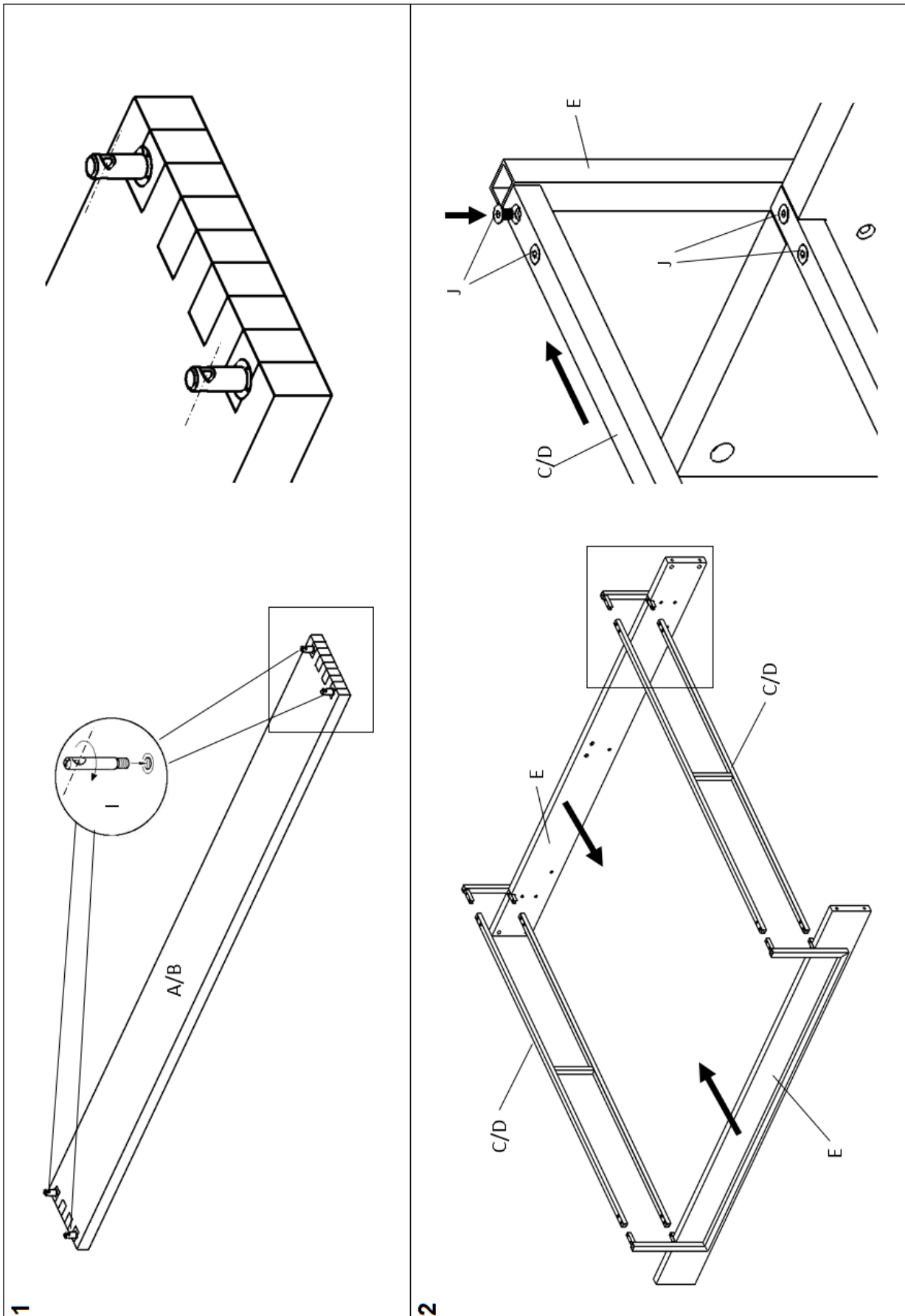

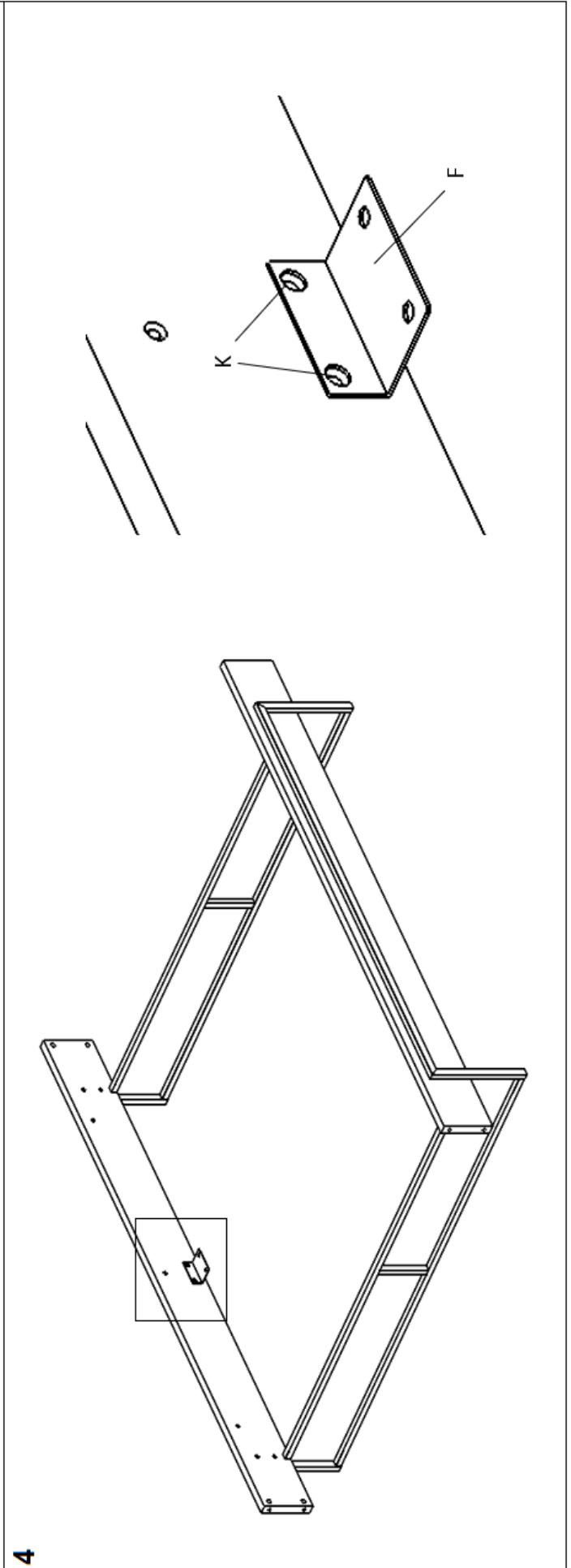
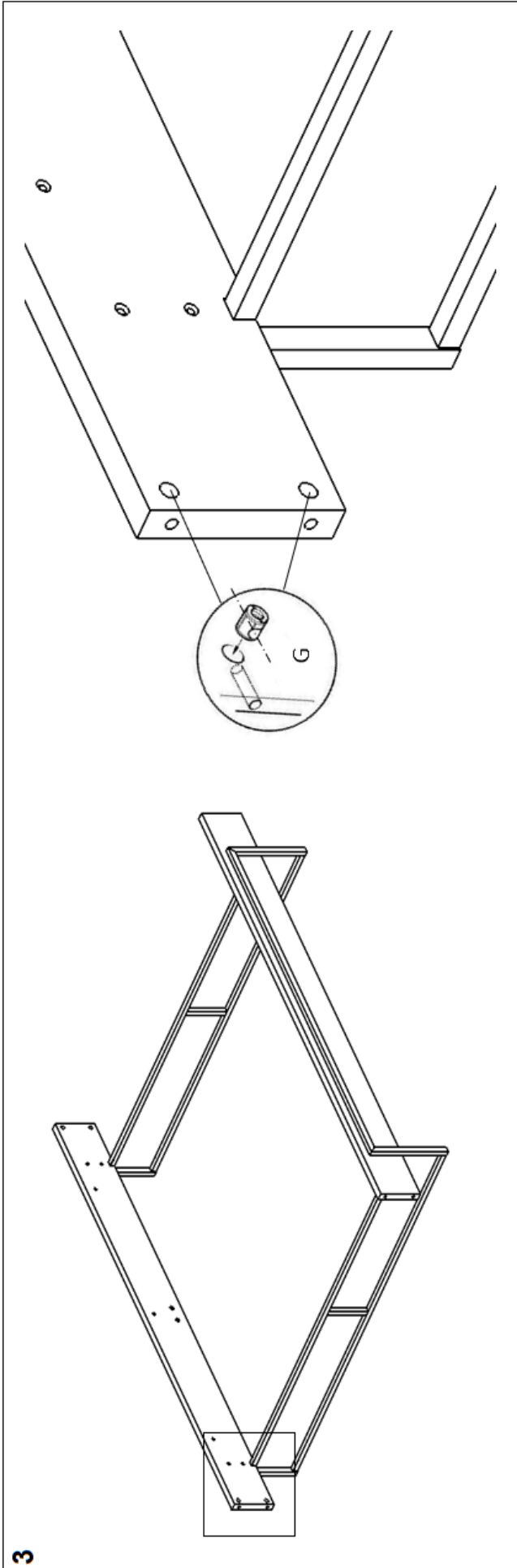

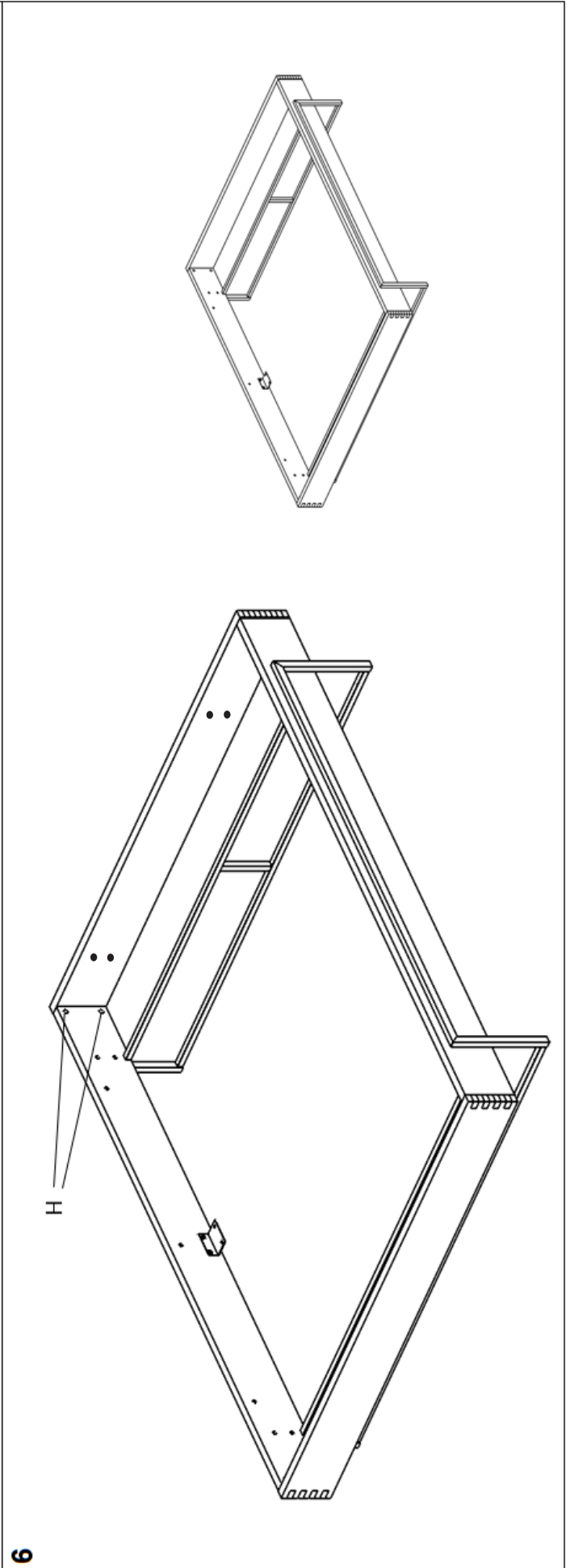
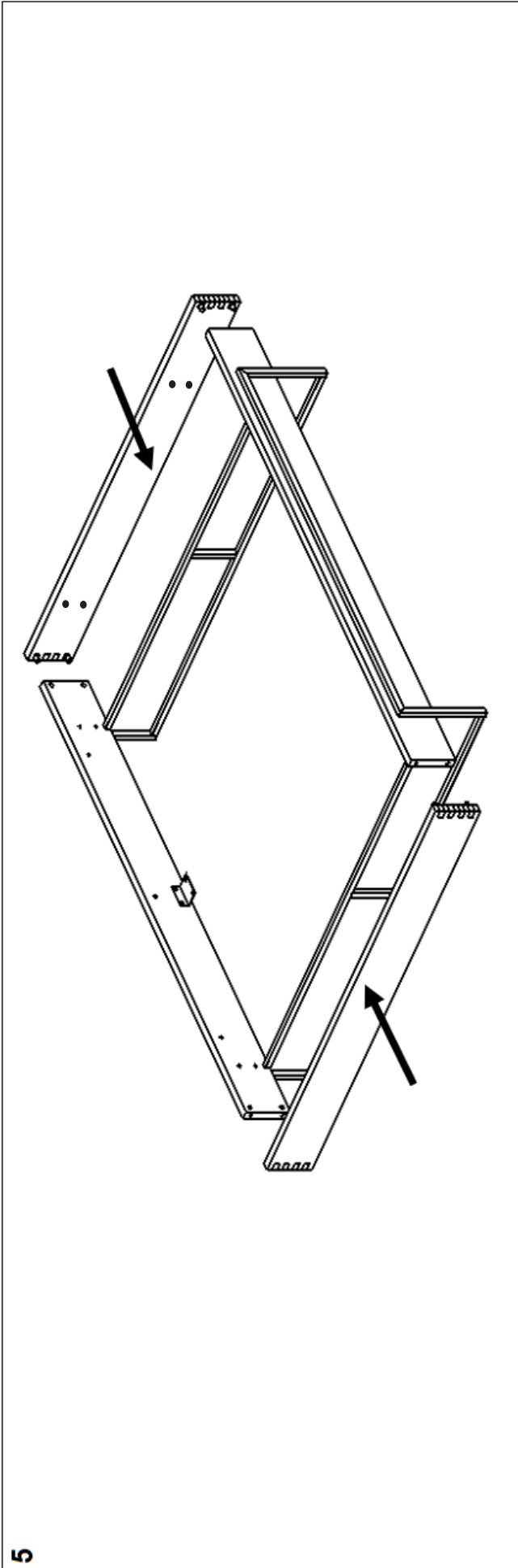



Reinigung allgemein:

Flecken immer sofort entfernen. Ein sauberes, weisses Tuch verwenden.

Nettoyage en général:

Toujours éliminer immédiatement les taches. Utiliser un chiffon blanc, propre.

Pulizia generale:

rimuovere sempre subito le macchie. Utilizzare un panno bianco, pulito.

General cleaning instructions:

Always remove stains immediately. Use a clean, white cloth.

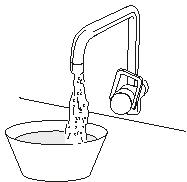

Sauberes Wasser verwenden. Lässt sich der Fleck so nicht entfernen, seifenhaltiges Wasser verwenden. Werden Reinigungsmittel verwendet, diese immer zuerst an einer nicht sichtbaren Stelle testen.

Utiliser une eau propre. Si la tache ne s'enlève pas, utiliser une eau savonneuse. Si un produit de nettoyage est utilisé, toujours l'essayer préalablement dans un endroit invisible.

Utilizzare acqua pulita. Se la macchia non viene via, utilizzare dell'acqua con sapone. Se si utilizzano dei detergenti, provarli sempre prima in un punto non visibile.

Use clean water. If the stain does not come out, use soapy water. If you use cleaning detergents, always test them first in a concealed spot.



ACHTUNG Keine chemischen, scheuern- oder kratzenden Reinigungs-/Hilfsmittel verwenden.

ATTENTION Ne pas utiliser de produits ou moyens chimiques, agressifs ou abrasifs.

ATTENZIONE Non utilizzare detergenti chimici o prodotti/materiali abrasivi.

CAUTION Do not use any chemical or abrasive cleaning detergents or cloths/tools.



Möbelpflege:

Lackiertes Holz nur mit einem leicht feuchten Tuch abwischen.

Entretien des meubles:

Essuyer le bois vernis uniquement avec un chiffon légèrement humide.

Cura dei mobili:

pulire il legno laccato utilizzando soltanto un panno leggermente umido.

Furniture care:

Only wipe varnished wood with a slightly damp cloth.

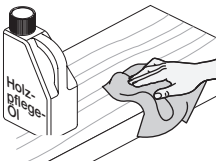

Geölte Holzoberflächen je nach Gebrauch, von Zeit zu Zeit (z.B. vierteljährlich) erneut ölen.

Pour les surfaces en bois huilé, appliquer de temps à autre (p.ex. tous les 3 mois) et en fonction de l'utilisation une huile pour bois.

Le superfici di legno oliate di tanto in tanto, a seconda del loro utilizzo (ad es. ogni tre mesi), devono essere nuovamente trattate con olio.

Re-oil oiled wooden surfaces from time to time (e.g. every three months) depending on use.



Feuchtigkeitsrückstände auf geölte und gewachsten Flächen müssen sofort entfernt werden. Ansonsten kommt es zu Fleckenbildung.

Les restes d'humidité sur les surfaces huilées et cirées doivent être immédiatement enlevés. Risque de formation de taches.

È necessario eliminare subito i residui di umidità dalle superfici oliate e cerate, altrimenti c'è il rischio che si formino delle macchie.

To prevent stains, immediately wipe off any wet spots on oiled and waxed surfaces.



ACHTUNG Keine chemischen, scheuern- oder kratzenden Reinigungs-/Hilfsmittel verwenden.

ATTENTION Ne pas utiliser de produits ou moyens chimiques, agressifs ou abrasifs.

ATTENZIONE Non utilizzare detergenti chimici o prodotti/materiali abrasivi.

CAUTION Do not use any chemical or abrasive cleaning detergents or cloths/tools.

5. **Wartung** **Entretien** **Manutenzione** **Maintenance**

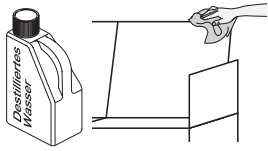

Leder/Stoff:
Flecken immer sofort mit destilliertem Wasser entfernen. Ein sauberes, weisses Tuch verwenden.

Cuir/tissu:
Toujours éliminer immédiatement les taches avec de l'eau distillée. Utiliser un chiffon blanc, propre.

Pelle/tessuto:
rimuovere sempre subito le macchie utilizzando acqua distillata. Utilizzare un panno bianco, pulito.

Leather/fabric:
Always remove stains immediately with distilled water. Use a clean, white cloth.

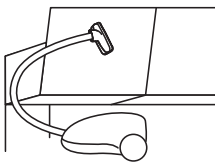

Oberflächen regelmäßig absaugen, damit durch Schmutz keine Abnutzungserscheinungen oder Schäden entstehen.

Aspirer régulièrement les surfaces afin d'éviter l'usure ou les dommages par la saleté.

Aspirare regolarmente in modo che lo sporco non logori o danneggi le superfici.

Vacuum surfaces on a regular basis so the dirt does not cause any signs of wear or damage.

6. **Wartung** **Entretien** **Manutenzione** **Maintenance**





Schrauben:
Für einwandfreie, zuverlässige Funktion, Schrauben regelmäßig nachziehen (z.B. vierteljährlich).

Vis:
Resserrer régulièrement les vis (p.ex. tous les 3 mois) pour assurer un fonctionnement sûr et correct.

Viti:
per garantire un funzionamento corretto e sicuro tirare regolarmente le viti (ad es. ogni tre mesi).

Screws:
To keep your furniture in good working order, tighten the screws regularly (e.g. every three months).

7.	Entsorgung	Élimination	Smaltimento	Disposal
	<p>Entsorgungsservice: Micasa bietet Ihnen einen Entsorgungsservice an. Weitere Informationen erhalten Sie unter www.micasa.ch</p>	<p>Service d'élimination: Micasa vous propose un service d'élimination. Vous trouverez des informations supplémentaires sur www.micasa.ch</p>	<p>Servizio di smaltimento: Micasa vi offre un servizio di smaltimento. Ulteriori informazioni sono disponibili su www.micasa.ch</p>	<p>Disposal service: Micasa offers a disposal service. For more information visit www.micasa.ch</p>
	<p>Entsorgung: Nicht mehr verwendete Möbel der fachgerechten Entsorgung übergeben. Wenden Sie sich an Ihre lokale Entsorgungsstelle.</p>	<p>Élimination: Veuillez remettre les meubles qui ne sont plus utilisés à une entreprise d'élimination. Adressez-vous à votre centre de collecte local.</p>	<p>Smaltimento: i mobili dismessi devono essere conferiti presso i centri di raccolta rifiuti per il loro corretto smaltimento. Rivolgersi presso il centro di raccolta locale.</p>	<p>Disposal: To correctly dispose of furniture that is no longer used, contact your local recycling centre.</p>

8.	Kontakt / Service	Contact / service	Contatto / servizio	Contact / service
	<p>Fragen / Anregungen: Wir sind gerne für Sie erreichbar: Montag bis Freitag 08.00 bis 18.00 Uhr Samstag 08.30 bis 16.30 Uhr Tel. 0800 840 848</p>	<p>Questions / suggestions: Nous sommes à votre disposition: Lundi - vendredi 08h00 à 18h00 Samedi 08h30 à 16h30 Tél. 0800 840 848</p>	<p>Domande / suggerimenti: siamo a vostra disposizione: lunedì - venerdì dalle 08.00 alle 18.00 sabato dalle 08.30 alle 16.30 Tel. 0800 840 848</p>	<p>Questions / Suggestions Please contact us. Our opening times are: Monday - Friday 8.00 to 18.00 Saturday 8.30 to 16.30 Phone 0800 840 848</p>
	<p>Ersatzteile: Erhalten Sie direkt im Online-Shop von Migros-Service: www.migros-service.ch</p>	<p>Pièces de rechange: Vous les obtenez directement dans le magasin en ligne de Migros-Service: www.migros-service.ch</p>	<p>Pezzi di ricambio: sono disponibili direttamente sull'online-shop di Migros-Service: www.migros-service.ch</p>	<p>Spare parts: Available directly from the Migros-Service online shop: www.migros-service.ch</p>