

**Wichtig:**

Vor Gebrauch sorgfältig durchlesen/  
Montageanleitung für  
späteres Nachlesen  
aufbewahren

**Important:**

Lisez attentivement/  
conserver les instruc-  
tions d'installation  
pour référence future  
avant utilisation

**Importante:**

lettura/conservare  
Istruzioni per l'installa-  
zione per riferimento  
futuro accuratamente  
prima dell'uso

**Important:**

Read carefully before  
assembling/keep and  
store Instruction for  
reference

# CAMPBELL

401511000020

401511000010

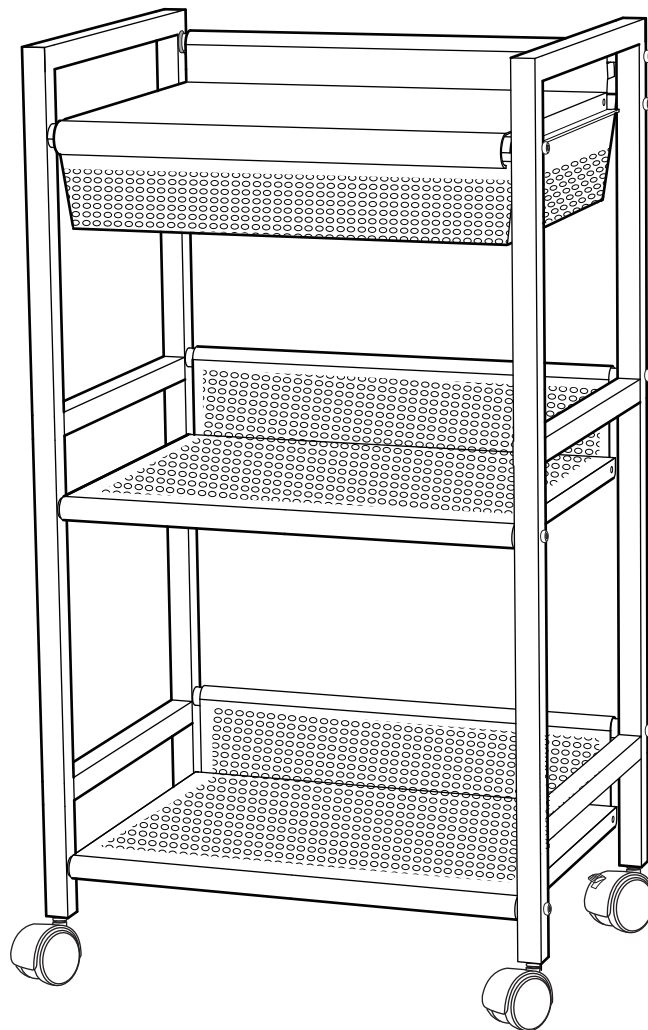



## Warnhinweise

### Bestimmungsgemässer Gebrauch:

Bitte achten Sie darauf, dass Ihre Möbel nur Ihrem Zweck gemäss verwendet werden. Für eine dauerhafte Funktionsfähigkeit ist eine sachgerechte Nutzung und regelmässige Unterhaltungspflege sehr wichtig.

## Mises en garde

### Utilisation conforme:

Veillez vous assurer que vos meubles sont utilisés uniquement pour leur usage prévu. Un entretien régulier et une utilisation conforme sont essentiels pour assurer un fonctionnement durable.

## Avvertenze

### Utilizzo per lo scopo previsto:

assicuratevi che i vostri mobili siano utilizzati solo per lo scopo per cui sono stati realizzati. Per garantire il loro funzionamento nel tempo è importante utilizzarli correttamente e sottoporli regolarmente a cure manutentive.

## Warning notice

### Intended use:

Please make sure that you only use your furniture for the purpose it was designed for. Correct use and regular maintenance are essential for ensuring your furniture remains in working order for the long-term.



### Anwendung:

Das Sitzen und Stehen auf Tischmöbel ist nicht gestattet, es ist kein Ersatz für Tritte oder Leitern.

### Usage:

Il n'est pas permis de s'asseoir ou de se mettre debout sur la table, elle n'est pas un substitut aux escaliers ou échelles.

### Impiego:

non è consentito sedersi o stare in piedi sul tavolo, non sostituisce un gradino o una scala.

### Area of use:

Sitting and standing on the table furniture is not permitted, the table is not a substitute for steps or ladders.

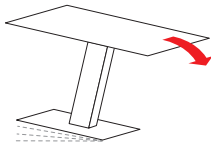

### VORSICHT, dieses Tischmöbel kann kippen:

Auf eine sichere Aufstellung des Tisches achten.

### PRÉCAUTION, cette table peut basculer:

S'assurer que la table soit stable.

### PRECAUZIONE, questo tavolo può ribaltarsi:

assicurarsi di posizionare il tavolo in modo stabile.

### PRECAUTION, this table furniture can tip over:

Make sure the table is positioned on a stable surface.



### Max. Belastung:

Tischfläche 3 kg.

### Charge max.:

3 kg par plateau.

### Carico max.:

superficie del tavolo 3 kg.

### Max. load:

Table surface 3 kg.

**Warnhinweise****Mises en garde****Avvertenze****Warning notice****WARNUNG  
Verschluck- und  
Erstickungsgefahr:**

Kleinteile und Verpackungsmaterial können verschluckt werden.

**AVERTISSEMENT  
Risque d'ingestion et  
d'étouffement:**

Les petites pièces et le matériel d'emballage peuvent être avalés.

**AVVERTENZA  
Pericolo di ingestione  
e soffocamento:**

piccole parti e materiale di imballaggio possono essere ingerite.

**WARNING  
Risk of swallowing  
and choking:**

Small parts and packaging material may be swallowed.



WARNUNG! Tüten und Folien sind kein Spielzeug! Bitte von Babys und Kleinkindern fernhalten! Nicht über den Kopf ziehen; Erstickungsgefahr!

AVERTISSEMENT! Les sacs et films ne sont pas des jouets! Veuillez les tenir hors de portée des bébés et jeunes enfants! Ne pas mettre sur la tête, risque d'étouffement!

AVVERTENZA! Sacchetti e pellicole non sono un giocattolo! Tenere lontano dalla portata dei neonati e dei bambini piccoli! Non metterli in testa, pericolo di soffocamento!

WARNING! Bags and film coverings are not toys! Please keep away from babies and small children! Do not put them over your head, risk of suffocation!



**VORSICHT,  
Verletzungsgefahr:**  
Kleinkinder dürfen sich nicht im Montage-Bereich aufhalten und an Möbeln hochziehen oder hinaufklettern.

**PRÉCAUTION,  
risque de blessures:**  
Les jeunes enfants ne peuvent pas se tenir dans la zone de montage ni tirer ou grimper sur des meubles.

**PRECAUZIONE,  
pericolo di lesioni:**  
tenere i bambini lontano dal luogo di montaggio e evitare che si appendano o arrampichino sul mobile.

**PRECAUTION,  
risk of injury:**  
Small children must keep away from the assembly area. They must refrain from climbing up on the furniture.



**Altersfreigabe:**  
Nicht für Kinder unter drei Jahren geeignet.

**Age minimum:**  
Ne convient pour les enfants de moins de trois ans.

**Limite di età:**  
non adatto per bambini sotto i tre anni.

**Age restriction:**  
Not suitable for children under three.

1.

**Allgemeine  
Hinweise**

**Remarques  
générales**

**Avvertenze  
generali**

**General  
information**

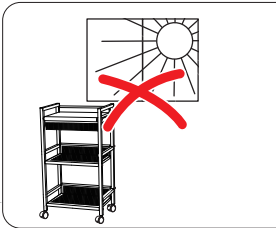

**ACHTUNG**  
**Direkte Sonneneinstrahlung:**  
Führt zu Farbveränderungen.

**ATTENTION**  
**Exposition directe au soleil:**  
Provoque des décolorations.

**ATTENZIONE**  
**Irraggiamento diretto del sole:**  
ne modifica il colore.

**ATTENTION**  
**Direct sunlight:**  
results in discolouration.

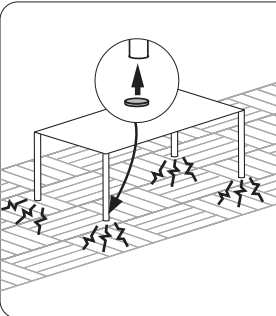

**Schutzgleiter:**  
Mit Schutzgleitern (z.B. aus Filz), lassen sich Schäden auf kratzempfindlichen Böden (z.B. Parkett) vermeiden.

**Patins:**  
Les patins (p.ex. en feutre) permettent d'éviter d'endommager les sols sensibles aux rayures (p.ex. parquet).

**Scivolante protettivo:**  
grazie agli scivolanti protettivi (ad es. feltro) si evita di danneggiare pavimenti sensibili ai graffi (ad es. parquet).

**Protective covers:**  
Protective covers, e.g. felt pads, prevent damage to floors that are easily scratched (e.g. parquet).

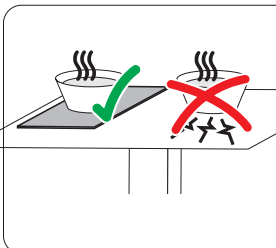

**ACHTUNG, Temperatur:**  
Nie heiße oder sehr kalte Objekte direkt auf die Oberfläche stellen. Geeigneten Schutz verwenden, z.B. Untersteller.

**ATTENTION, température:**  
Ne jamais poser des objets chauds ou très froids directement sur la surface. Utiliser une protection appropriée, p.ex. sous-plat.

**ATTENZIONE, temperatura:** non appoggiare mai oggetti caldi o molto freddi direttamente sulla superficie. Utilizzare una protezione adatta, ad es. un sotto piatto.

**ATTENTION, temperature:**  
Do not place hot or cold objects directly on the surface. Use the appropriate protection, e.g. saucer.

2.

**Montagehinweise**

**Instructions de montage**

**Istruzioni di montaggio**

**Assembly information**

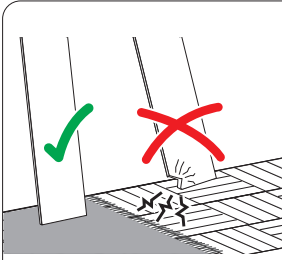

**Montageschäden:**  
Vermeiden Sie indem Sie einen sauberen und weichen Untergrund verwenden (z.B. Teppich). Teile beim Auspacken oder während der Montage nur auf weiche Unterlagen legen/stellen. Darauf achten, dass grössere Teile nicht kippen können.

**Dommages au montage:**  
Évitez les dommages en utilisant un fond propre et doux (p.ex. tapis). Lors du déballage et montage, posez/placez les éléments uniquement sur un fond doux. Assurez-vous que les grands éléments ne peuvent pas basculer.

**Danni in fase di montaggio:**  
evitare di causare danni utilizzando una base pulita e morbida (ad es. tappeto). Nella fase di disimballaggio e durante il montaggio, appoggiare i pezzi esclusivamente su una base morbida. Fare attenzione che i pezzi più grandi non si ribaltino.

**Damages during assembly:**  
These can be avoided if you use a clean soft surface (e.g. carpet). Only place parts on a soft surface when unpacking or during the assembly. Make sure that larger parts cannot tip over.



**Personen:**  
Für die Montage erforderliche Anzahl Personen.

**Personnes:**  
Nombre de personnes nécessaires au montage.

**Persone:**  
numero di persone necessarie per il montaggio.

**People:**  
Number of people required for the assembly.



**Montagerichtzeit:**  
Ungefähre Zeit in Stunden.

**Durée indicative du montage:**  
Durée approximative en heures.

**Tempo di montaggio:**  
tempo in ore approssimativo.

**Assembly time:**  
Approximate time in 15 mins.

**Benötigtes Werkzeug**

**Outils nécessaires**

**Attrezzi necessari**

**Tools required**

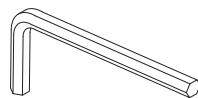

**Bau-/Kleinteile:**

**Éléments / pièces:**

**Componenti / piccoli pezzi**

**Components / small parts**

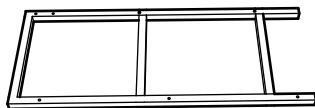

x2  
**1**

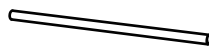

x1  
**2**

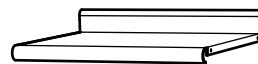

x1  
**3**

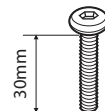

x14  
**A**

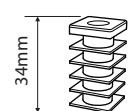

x4  
**B**

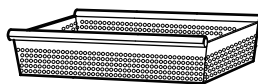

x1  
**4**

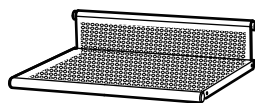

x2  
**5**



x2  
**6**



x2  
**7**



x2  
**C**



x2  
**D**

3.

Montage-  
anleitung

Instructions de  
montage

Istruzioni per  
il montaggio

Assembling  
instruction

1

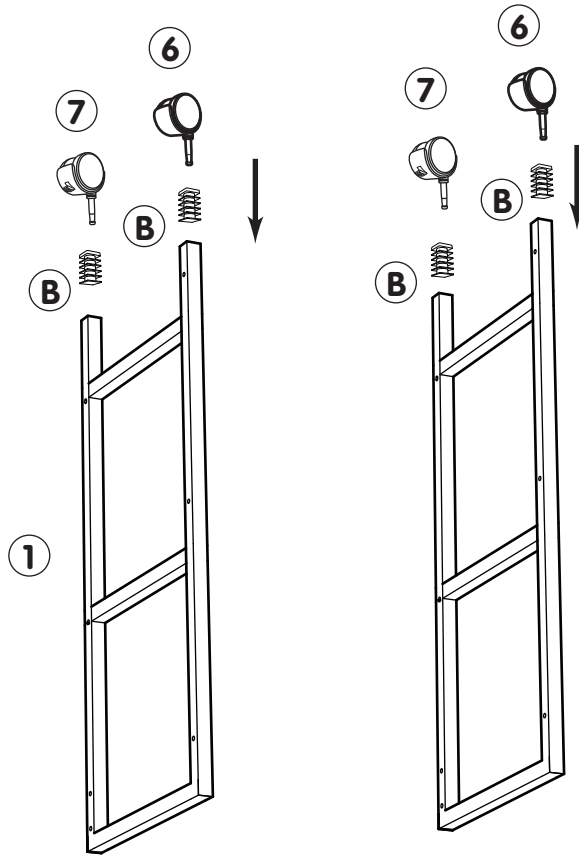

2

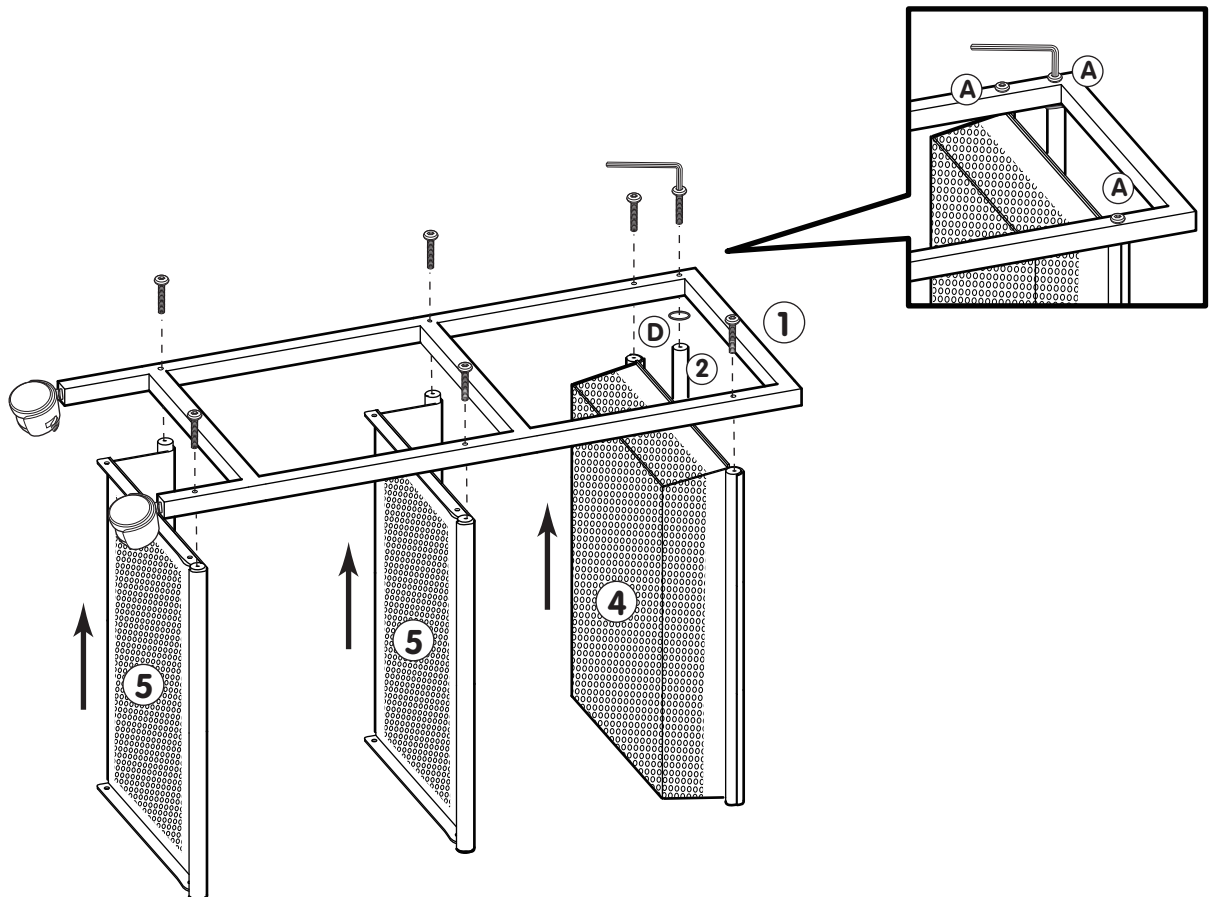

3

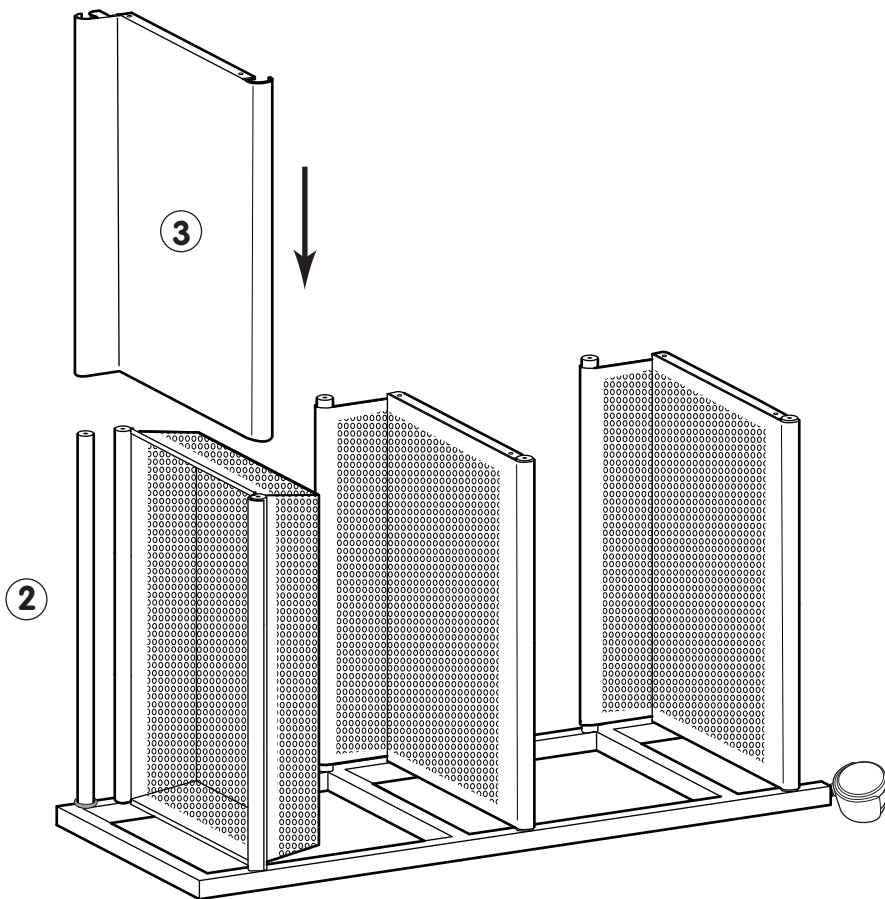

4

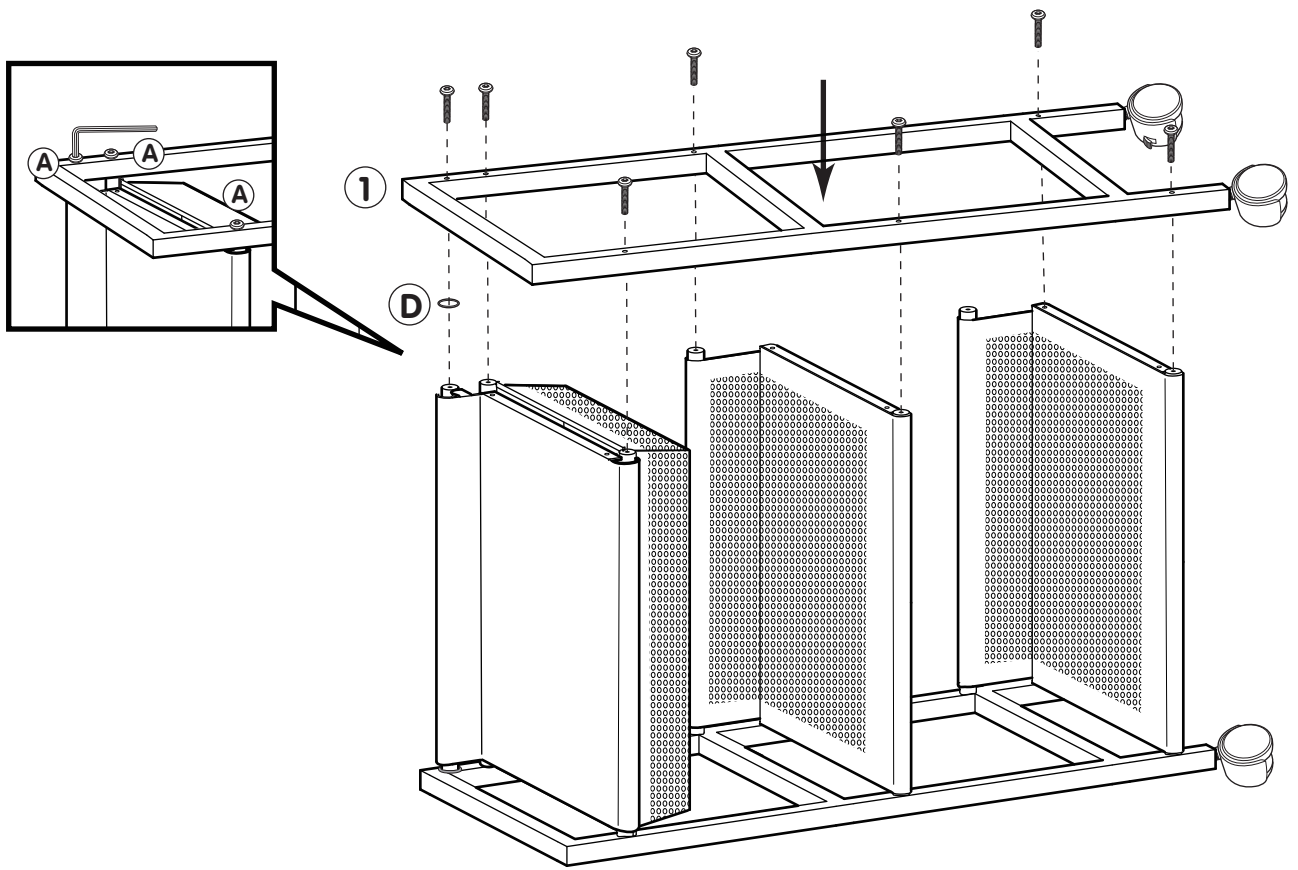

5

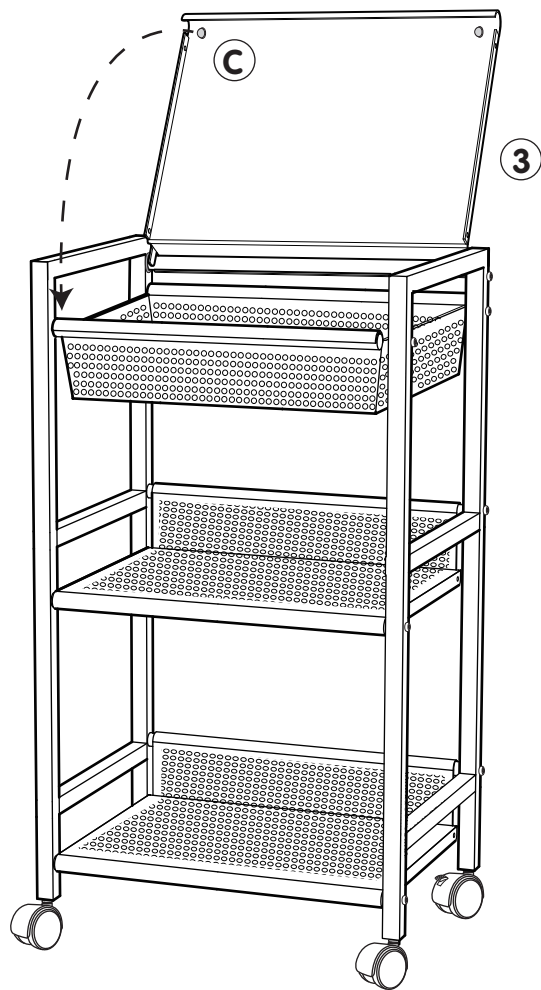

6

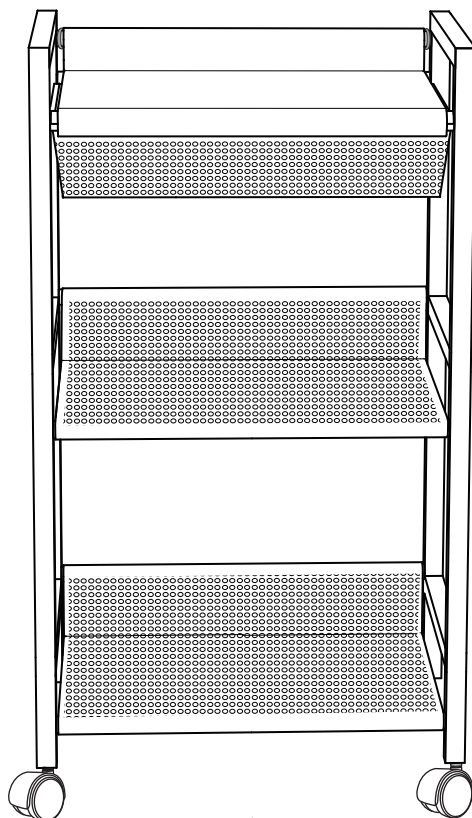



**Reinigung allgemein:**

Flecken immer sofort entfernen. Ein sauberes, weisses Tuch verwenden.



Sauberes Wasser verwenden. Lässt sich der Fleck so nicht entfernen, seifenhaltiges Wasser verwenden. Werden Reinigungsmittel verwendet, diese immer zuerst an einer nicht sichtbaren Stelle testen.



**ACHTUNG** Keine chemischen, scheuern- oder kratzenden Reinigungs-/Hilfsmittel verwenden.

**Nettoyage en général:**

Toujours éliminer immédiatement les taches. Utiliser un chiffon blanc, propre.

Utiliser une eau propre. Si la tache ne s'enlève pas, utiliser une eau savonneuse. Si un produit de nettoyage est utilisé, toujours l'essayer préalablement dans un endroit invisible.

**ATTENTION** Ne pas utiliser de produits ou moyens chimiques, agressifs ou abrasifs.

**Pulizia generale:**

rimuovere sempre subito le macchie. Utilizzare un panno bianco, pulito.

Utilizzare acqua pulita. Se la macchia non viene via, utilizzare dell'acqua con sapone. Se si utilizzano dei detergenti, provarli sempre prima in un punto non visibile.

**ATTENZIONE** Non utilizzare detergenti chimici o prodotti/materiali abrasivi.

**General cleaning instructions:**

Always remove stains immediately. Use a clean, white cloth.

Use clean water. If the stain does not come out, use soapy water. If you use cleaning detergents, always test them first in a concealed spot.

**CAUTION** Do not use any chemical or abrasive cleaning detergents or cloths/tools.

5.	Wartung	Entretien	Manutenzione	Maintenance
	<p><b>Schrauben:</b> Für einwandfreie, zuverlässige Funktion, Schrauben regelmässig nachziehen (z.B. vierteljährlich).</p>	<p><b>Vis:</b> Resserrer régulièrement les vis (p.ex. tous les 3 mois) pour assurer un fonctionnement sûr et correct.</p>	<p><b>Viti:</b> per garantire un funzionamento corretto e sicuro tirare regolarmente le viti (ad es. ogni tre mesi).</p>	<p><b>Screws:</b> To keep your furniture in good working order, tighten the screws regularly (e.g. every three months).</p>

6.	Entsorgung	Élimination	Smaltimento	Disposal
	<p>Entsorgungsservice: Micasa bietet Ihnen einen Entsorgungsservice an. Weitere Informationen erhalten Sie unter <a href="http://www.micasa.ch">www.micasa.ch</a></p> <p>Entsorgung: Nicht mehr verwendete Möbel der fachgerechten Entsorgung übergeben. Wenden Sie sich an Ihre lokale Entsorgungsstelle.</p>	<p>Service d'élimination: Micasa vous propose un service d'élimination. Vous trouverez des informations supplémentaires sur <a href="http://www.micasa.ch">www.micasa.ch</a></p> <p>Élimination: Veuillez remettre les meubles qui ne sont plus utilisés à une entreprise d'élimination. Adressez-vous à votre centre de collecte local.</p>	<p>Servizio di smaltimento: Micasa vi offre un servizio di smaltimento. Ulteriori informazioni sono disponibili su <a href="http://www.micasa.ch">www.micasa.ch</a></p> <p>Smaltimento: i mobili dismessi devono essere conferiti presso i centri di raccolta rifiuti per il loro corretto smaltimento. Rivolgersi presso il centro di raccolta locale.</p>	<p>Disposal service: Micasa offers a disposal service. For more information visit <a href="http://www.micasa.ch">www.micasa.ch</a></p> <p>Disposal: To correctly dispose of furniture that is no longer used, contact your local recycling centre.</p>

7.	Kontakt / Service	Contact / service	Contatto / servizio	Contact / service
	<p>Fragen / Anregungen: Wir sind gerne für Sie erreichbar: Montag bis Freitag 08.00 bis 18.00 Uhr Samstag 08.30 bis 16.30 Uhr Tel. 0800 840 848</p>	<p>Questions / suggestions: Nous sommes à votre disposition: Lundi - vendredi 08h00 à 18h00 Samedi 08h30 à 16h30 Tél. 0800 840 848</p>	<p>Domande / suggerimenti: siamo a vostra disposizione: lunedì - venerdì dalle 08.00 alle 18.00 sabato dalle 08.30 alle 16.30 Tel. 0800 840 848</p>	<p>Questions / Suggestions Please contact us. Our opening times are: Monday - Friday 8.00 to 18.00 Saturday 8.30 to 16.30 Phone 0800 840 848</p>
	<p>Ersatzteile: Erhalten Sie direkt im Online-Shop von Migros-Service: <a href="http://www.migros-service.ch">www.migros-service.ch</a></p>	<p>Pièces de rechange: Vous les obtenez directement dans le magasin en ligne de Migros-Service: <a href="http://www.migros-service.ch">www.migros-service.ch</a></p>	<p>Pezzi di ricambio: sono disponibili direttamente sull'online-shop di Migros-Service: <a href="http://www.migros-service.ch">www.migros-service.ch</a></p>	<p>Spare parts: Available directly from the Migros-Service online shop: <a href="http://www.migros-service.ch">www.migros-service.ch</a></p>