

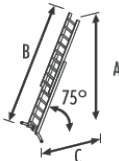

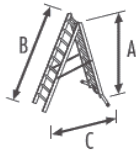
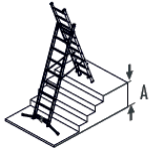
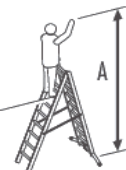
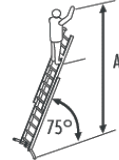

# Produktdatenblatt

	
Marke	
Art.-Nr.	630917000000
	2 x 9
	A = 392 cm B = 406 cm C = 116 cm
	A = 255 cm B = 261 cm C = 169 cm
	A = 52 cm
	A = 381 cm
	A = 495 cm
	A = 271 cm B = 46 cm C = 10 cm
	11.5