









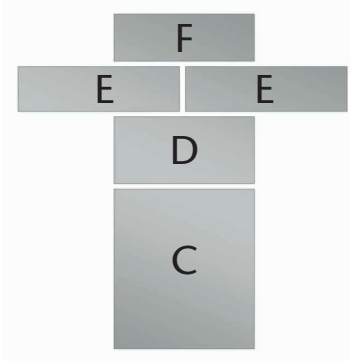

<p><b>4 ×</b></p>  <p>SCHR. 325 6,3 × 10,5 mm</p>	<p><b>6 ×</b></p>  <p>SCHR. 364 6,3 × 30 mm</p>	<p><b>6 ×</b></p>  <p>BESC. 653</p>		 
<p><b>2 ×</b></p>  <p>BESC. 774</p>	<p><b>2 ×</b></p>  <p>SCHR. 412 M4 × 16 mm</p>	<p><b>2 ×</b></p>  <p>SCHR. 413 M4 × 60 mm</p>		

M: 1:1



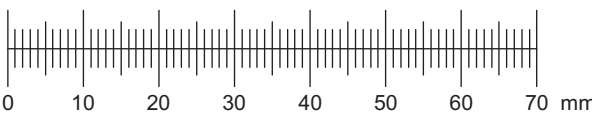
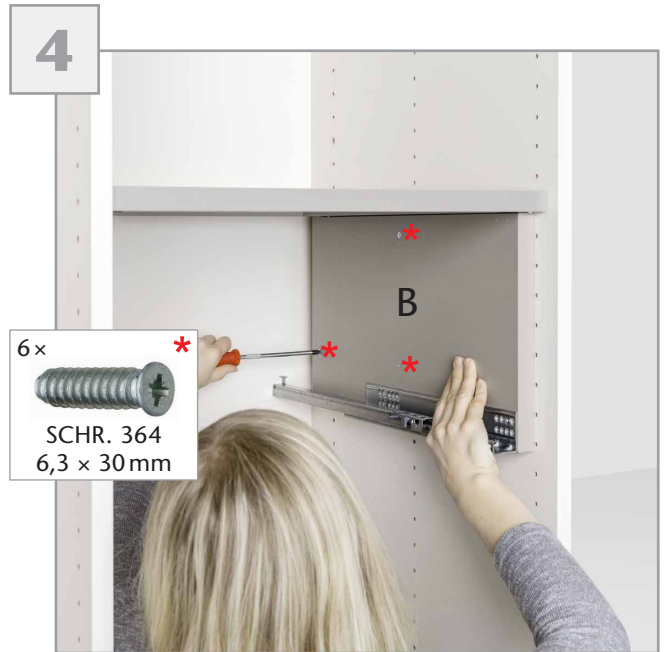
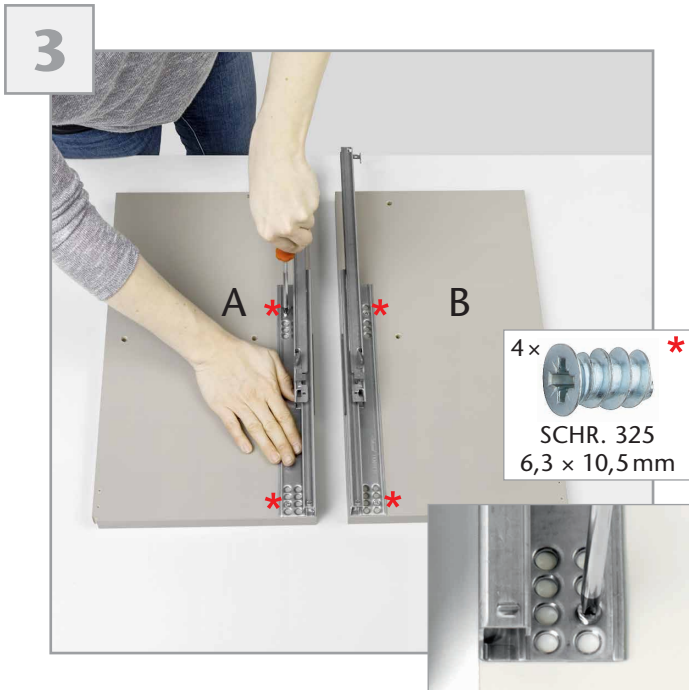
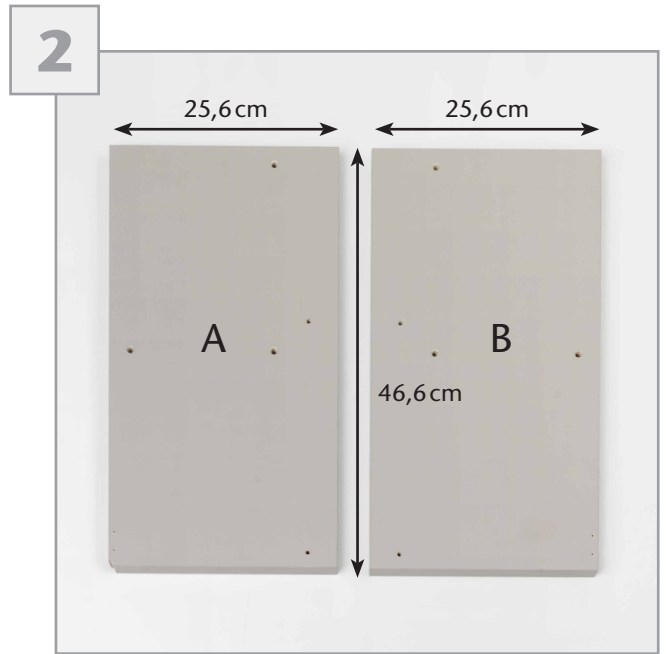

6



7



8



9



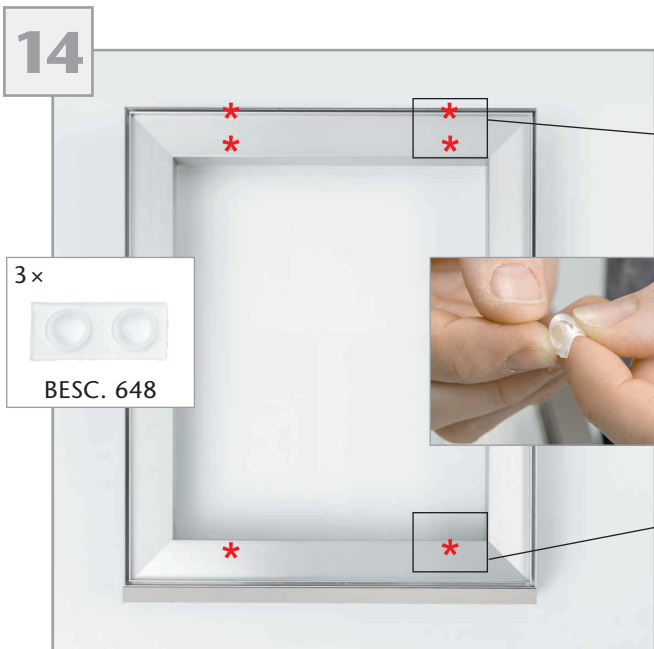
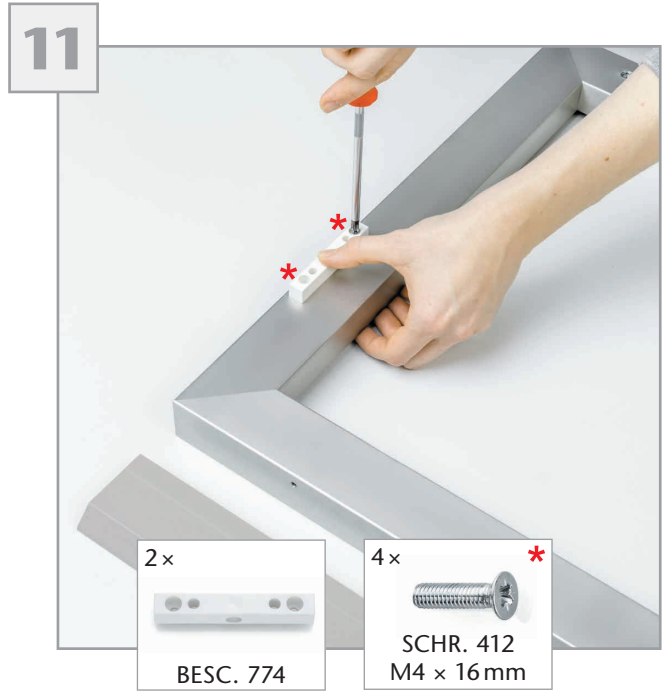
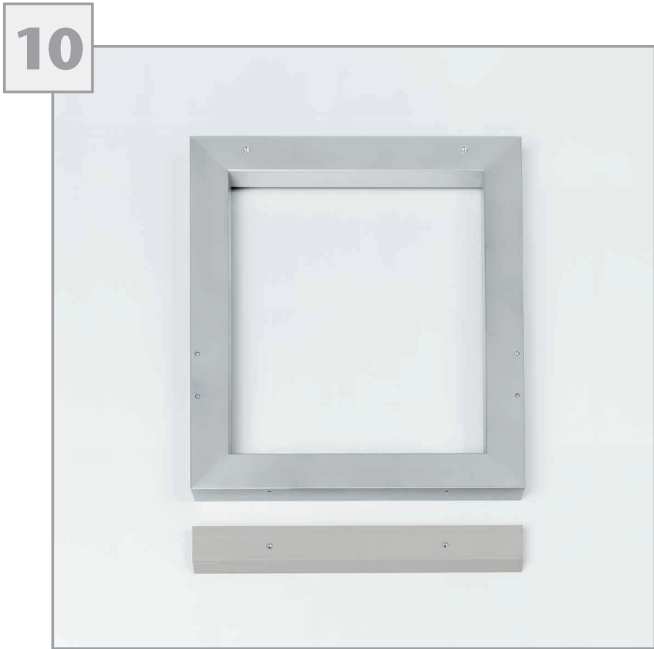

15

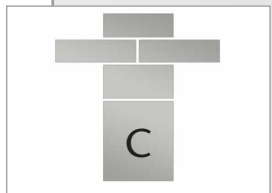

16

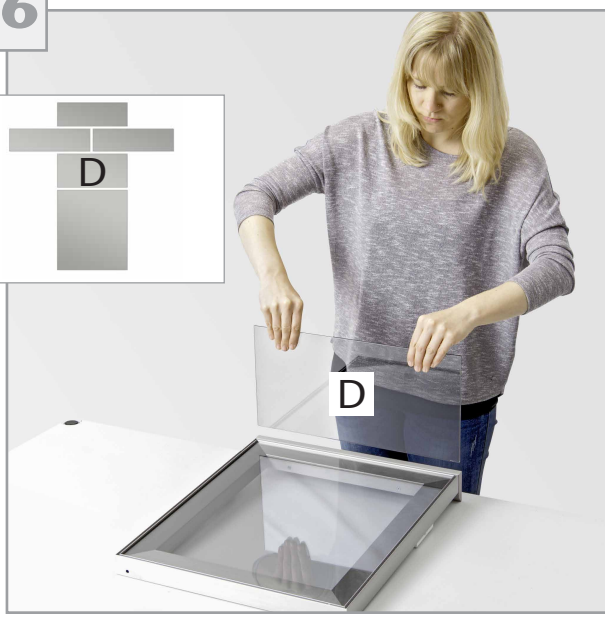
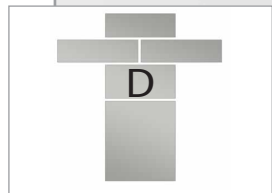

17



18

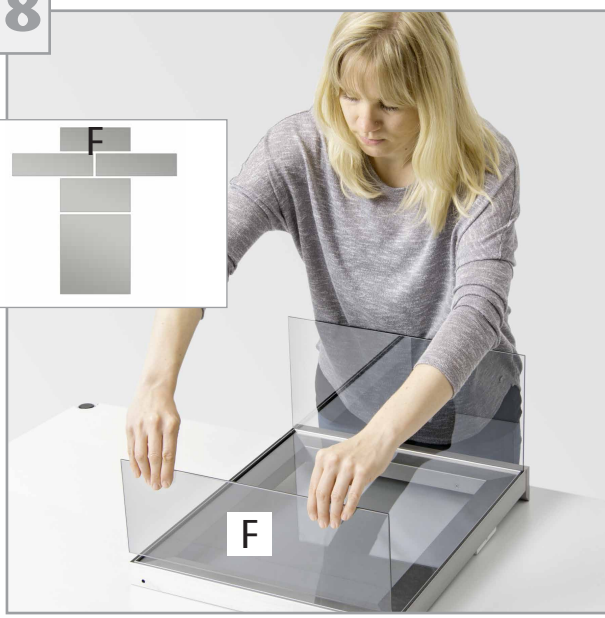
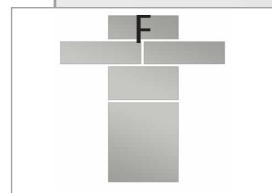

19

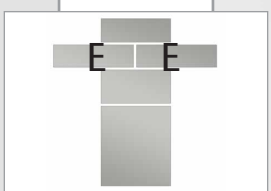

20

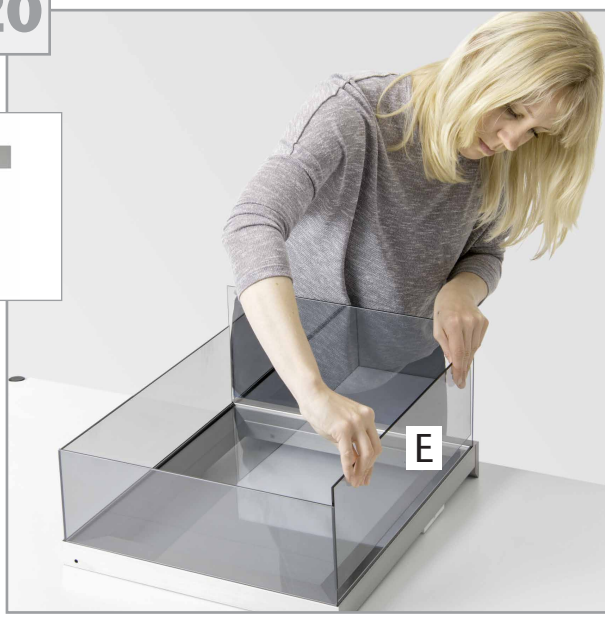

21



22



23

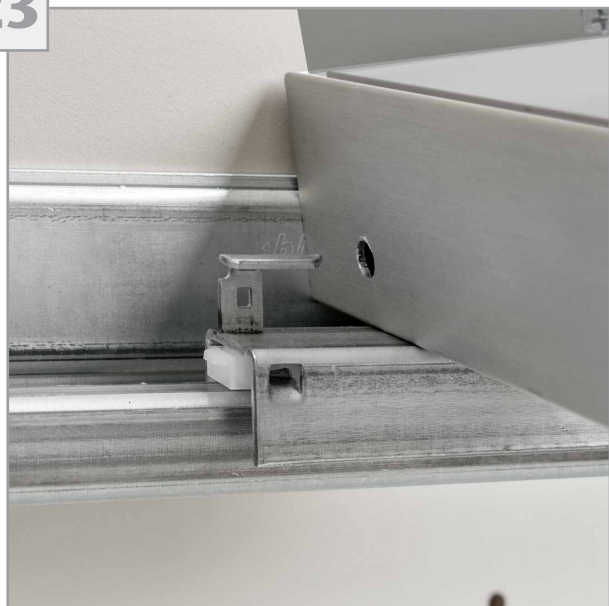

24



25



26

