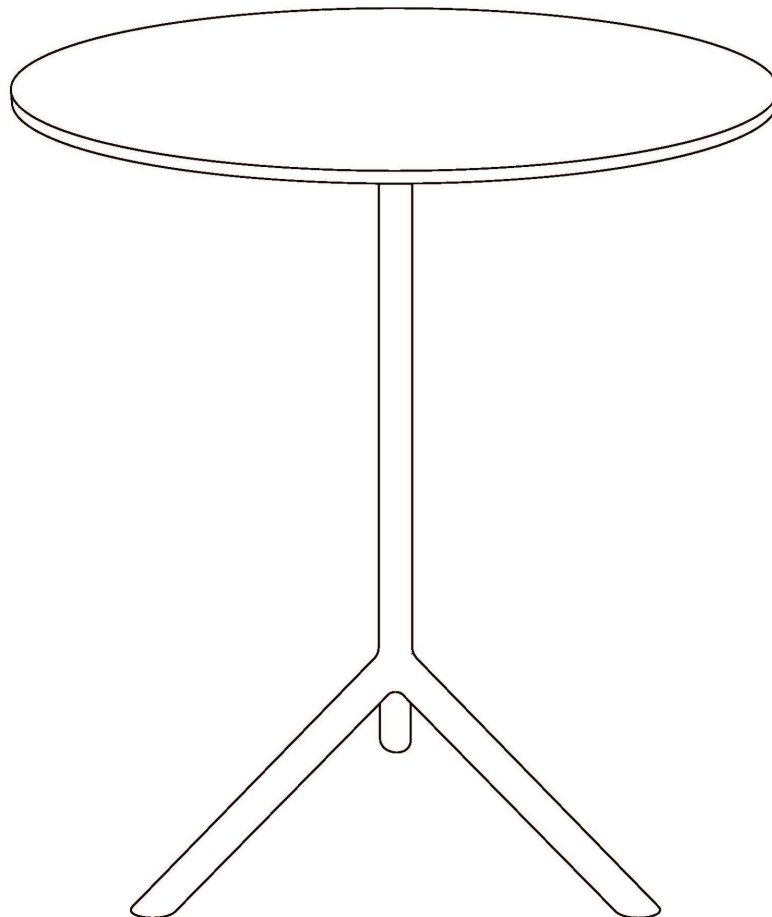

Wichtig:
Vor Gebrauch sorgfältig durchlesen/
Montageanleitung für
späteres Nachlesen
aufbewahren

Important:
Lisez attentivement/
conserver les instruc-
tions d'installation
pour référence future
avant utilisation

Importante:
lettura/conservare
Istruzioni per l'installa-
zione per riferimento
futuro accuratamente
prima dell'uso

Important:
Read carefully before
assembling/keep and
store Instruction for
reference

MYA





Warnhinweise

Bestimmungsgemässer Gebrauch:

Bitte achten Sie darauf, dass Ihre Möbel nur Ihrem Zweck gemäss verwendet werden. Für eine dauerhafte Funktionsfähigkeit ist eine sachgerechte Nutzung und regelmässige Unterhaltspflege sehr wichtig.

Mises en garde

Utilisation conforme:

Veillez vous assurer que vos meubles sont utilisés uniquement pour leur usage prévu. Un entretien régulier et une utilisation conforme sont essentiels pour assurer un fonctionnement durable.

Avvertenze

Utilizzo per lo scopo previsto:

assicuratevi che i vostri mobili siano utilizzati solo per lo scopo per cui sono stati realizzati. Per garantire il loro funzionamento nel tempo è importante utilizzarli correttamente e sottoporli regolarmente a cure manutentive.

Warning notice

Intended use:

Please make sure that you only use your furniture for the purpose it was designed for. Correct use and regular maintenance are essential for ensuring your furniture remains in working order for the long-term.

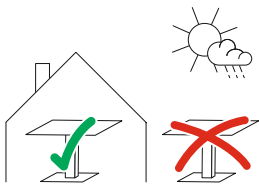

Anwendung:

Das von Ihnen erworbene Tischmöbel eignet sich für den allgemeinen, privaten Wohnbereich. Es ist nicht für den Nass-, Aussen- oder gewerblichen Bereich geeignet.

Usage:

La table que vous avez achetée convient pour l'habitat privé en général. Elle ne convient pas pour l'extérieur, les milieux humides ou le domaine commercial.

Impiego:

la seduta acquistata è adatta per essere utilizzata in generale, in ambito domestico. Non è adatta per gli esterni, per l'esposizione alla pioggia o per ambienti commerciali.

Area of use:

The table furniture you have purchased is suitable for use in general private living quarters. It is not suitable for areas that are wet, outside or used for commercial purposes.

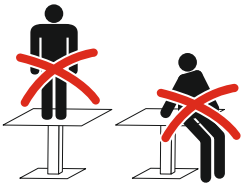

Anwendung:

Das Sitzen und Stehen auf Tischmöbel ist nicht gestattet, es ist kein Ersatz für Tritte oder Leitern.

Usage:

Il n'est pas permis de s'asseoir ou de se mettre debout sur la table, elle n'est pas un substitut aux escaliers ou échelles.

Impiego:

non è consentito sedersi o stare in piedi sul tavolo, non sostituisce un gradino o una scala.

Area of use:

Sitting and standing on the table furniture is not permitted, the table is not a substitute for steps or ladders.

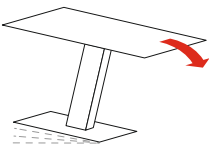

VORSICHT, dieses Tischmöbel kann kippen:

Auf eine sichere Aufstellung des Tisches achten.

PRÉCAUTION, cette table peut basculer:

S'assurer que la table soit stable.

PRECAUZIONE, questo tavolo può ribaltarsi:

assicurarsi di posizionare il tavolo in modo stabile.

PRECAUTION, this table furniture can tip over:

Make sure the table is positioned on a stable surface.



Max. Belastung:

Tischfläche 10 kg.

Charge max.:

10 kg par plateau

Carico max.:

superficie del tavolo 10 kg.

Max. load:

Table surface 10kg.



Warnhinweise

Mises en garde

Avvertenze

Warning notice



**WARNUNG
Verschluck- und
Erstickungsgefahr:**

Kleinteile und Verpackungsmaterial können verschluckt werden.

**AVERTISSEMENT
Risque d'ingestion et
d'étouffement:**

Les petites pièces et le matériel d'emballage peuvent être avalés.

**AVVERTENZA
Pericolo di ingestione
e soffocamento:**

piccole parti e materiale di imballaggio possono essere ingerite.

**WARNING
Risk of swallowing
and choking:**

Small parts and packaging material may be swallowed.



WARNUNG! Tüten und Folien sind kein Spielzeug! Bitte von Babys und Kleinkindern fernhalten! Nicht über den Kopf ziehen; Erstickungsgefahr!

AVERTISSEMENT! Les sacs et films ne sont pas des jouets! Veuillez les tenir hors de portée des bébés et jeunes enfants! Ne pas mettre sur la tête, risque d'étouffement!

AVVERTENZA! Sacchetti e pellicole non sono un giocattolo! Tenere lontano dalla portata dei neonati e dei bambini piccoli! Non metterli in testa, pericolo di soffocamento!

WARNING! Bags and film coverings are not toys! Please keep away from babies and small children! Do not put them over your head, risk of suffocation!



**VORSICHT,
Verletzungsgefahr:**

Kleinkinder dürfen sich nicht im Montage-Bereich aufhalten und an Möbeln hochziehen oder hinaufklettern.

**PRÉCAUTION,
risque de blessures:**

Les jeunes enfants ne peuvent pas se tenir dans la zone de montage ni tirer ou grimper sur des meubles.

**PRECAUZIONE,
pericolo di lesioni:**

tenere i bambini lontano dal luogo di montaggio e evitare che si appendano o arrampichino sul mobile.

**PRECAUTION,
risk of injury:**

Small children must keep away from the assembly area. They must refrain from climbing up on the furniture.



1.

**Allgemeine
Hinweise**

**Remarques
générales**

**Avvertenze
generali**

**General
information**

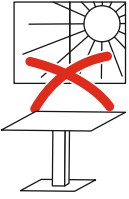

**ACHTUNG
Direkte Sonnenein-
strahlung:**
Führt zu Farbverände-
rungen.

**ATTENTION
Exposition directe au
soleil:**
Provoque des décolo-
rations.

**ATTENZIONE
Irraggiamento diretto
del sole:**
ne modifica il colore.

**ATTENTION
Direct sunlight:**
results in discolour-
ation.

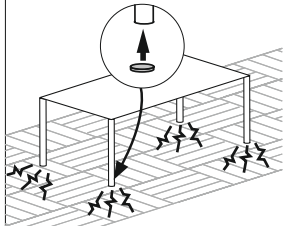

Schutzgleiter:
Mit Schutzgleitern (z.B.
aus Filz), lassen sich
Schäden auf kratzem-
pfindlichen Böden (z.B.
Parkett) vermeiden.

Patins:
Les patins (p.ex. en
feutre) permettent
d'éviter d'endomma-
ger les sols sensibles
aux rayures (p.ex. par-
quet).

Scivolante protettivo:
grazie agli scivolanti
protettivi (ad es. feltro)
si evita di danneggiare
pavimenti sensibili ai
graffi (ad es. parquet).

Protective covers:
Protective covers, e.g.
felt pads, prevent
damage to floors that
are easily scratched
(e.g. parquet).

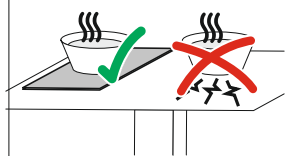

**ACHTUNG,
Temperatur:**
Nie heiße oder sehr
kalte Objekte direkt
auf die Oberfläche
stellen. Geeigneten
Schutz verwenden, z.B.
Untersteller.

**ATTENTION,
température:**
Ne jamais poser des
objets chauds ou très
froids directement sur
la surface. Utiliser une
protection appropriée,
p.ex. sous-plat.

**ATTENZIONE,
temperatura:** non ap-
poggiare mai ogget-
ti caldi o molto freddi
direttamente sulla su-
perficie. Utilizzare una
protezione adatta, ad
es. un sotto piatto.

**ATTENTION,
temperature:**
Do not place hot or
cold objects directly on
the surface. Use the
appropriate protec-
tion, e.g. saucer.

Unikat:
Dieses Produkt wurde
von Hand hergestellt
und jedes Stück ist
einzigartig.

Pièce unique:
Ce produit a été réali-
sé à la main et chaque
pièce est unique.

Esemplare unico:
questo prodotto è sta-
to realizzato a mano e
ogni esemplare è un
pezzo unico.

Unique:
This product has been
made by hand and
therefore each piece is
unique.

2.

Montagehinweise

Instructions de montage

Istruzioni di montaggio

Assembly information

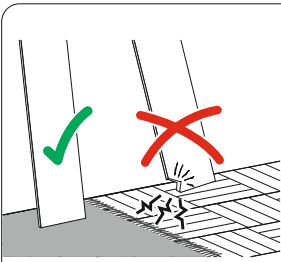

Montageschäden:

Vermeiden Sie indem Sie einen sauberen und weichen Untergrund verwenden (z.B. Teppich). Teile beim Auspacken oder während der Montage nur auf weiche Unterlagen legen/stellen. Darauf achten, dass grössere Teile nicht kippen können.

Domages au montage:

Évitez les dommages en utilisant un fond propre et doux (p.ex. tapis). Lors du déballage et montage, posez/placez les éléments uniquement sur un fond doux. Assurez-vous que les grands éléments ne peuvent pas basculer.

Danni in fase di montaggio:

evitare di causare danni utilizzando una base pulita e morbida (ad es. tappeto). Nella fase di disimballaggio e durante il montaggio, appoggiare i pezzi esclusivamente su una base morbida. Fare attenzione che i pezzi più grandi non si ribaltino.

Damages during assembly:

These can be avoided if you use a clean soft surface (e.g. carpet). Only place parts on a soft surface when unpacking or during the assembly. Make sure that larger parts cannot tip over.



Personen:

Für die Montage erforderliche Anzahl Personen.

Personnes:

Nombre de personnes nécessaires au montage.

Persone:

numero di persone necessarie per il montaggio.

People:

Number of people required for the assembly.



Montagerichtzeit:

Ungefähre Zeit in Stunden.

Durée indicative du montage:

Durée approximative en heures.

Tempo di montaggio:

tempo in ore approssimativo.

Assembly time:

Approximate time in hours.

Bau-/Kleinteile:

Éléments / pièces:

Componenti / piccoli pezzi

Components / small parts

1

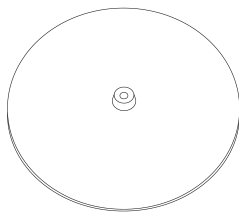

2

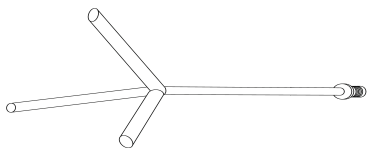

3.

Montage-
anleitung

Instructions de
montage

Istruzioni per
il montaggio

Assembling
instruction

1

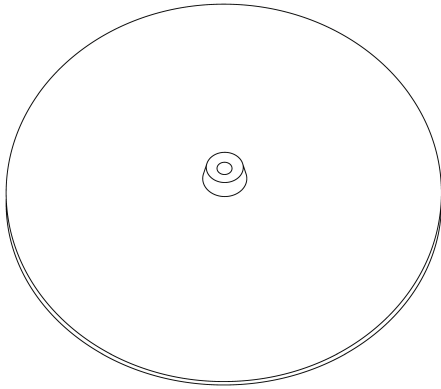

2

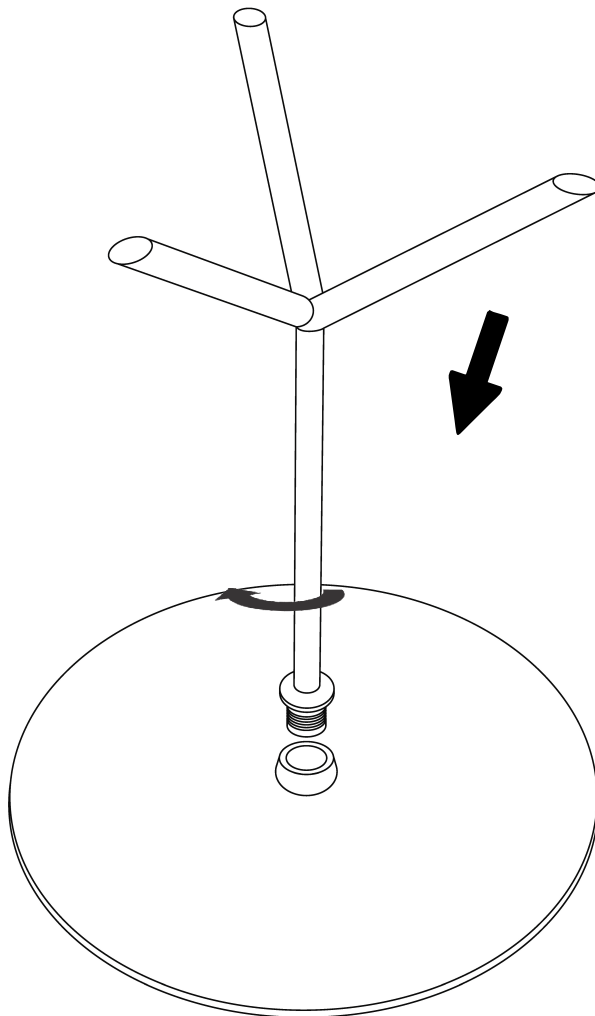

3 

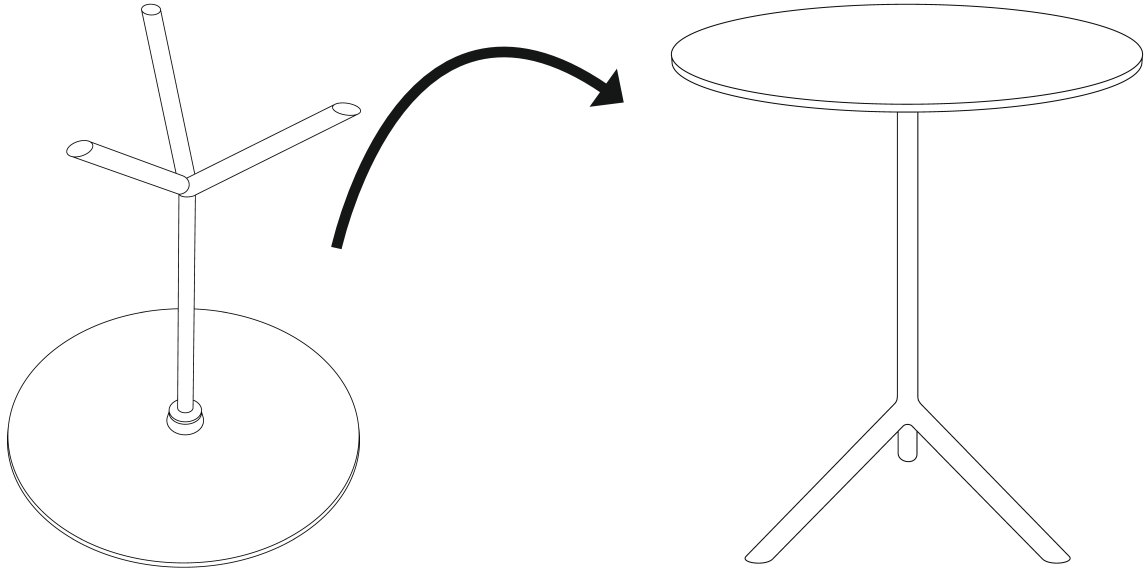

**Reinigung allgemein:**

Flecken immer sofort entfernen. Ein sauberes, weisses Tuch verwenden.

Nettoyage en général:

Toujours éliminer immédiatement les taches. Utiliser un chiffon blanc, propre.

Pulizia generale:

rimuovere sempre subito le macchie. Utilizzare un panno bianco, pulito.

General cleaning instructions:

Always remove stains immediately. Use a clean, white cloth.



Sauberes Wasser verwenden. Lässt sich der Fleck so nicht entfernen, seifenhaltiges Wasser verwenden. Werden Reinigungsmittel verwendet, diese immer zuerst an einer nicht sichtbaren Stelle testen.

Utiliser une eau propre. Si la tache ne s'enlève pas, utiliser une eau savonneuse. Si un produit de nettoyage est utilisé, toujours l'essayer préalablement dans un endroit invisible.

Utilizzare acqua pulita. Se la macchia non viene via, utilizzare dell'acqua con sapone. Se si utilizzano dei detergenti, provarli sempre prima in un punto non visibile.

Use clean water. If the stain does not come out, use soapy water. If you use cleaning detergents, always test them first in a concealed spot.



ACHTUNG Keine chemischen, scheuern- oder kratzenden Reinigungs-/Hilfsmittel verwenden.

ATTENTION Ne pas utiliser de produits ou moyens chimiques, agressifs ou abrasifs.

ATTENZIONE Non utilizzare detergenti chimici o prodotti/materiali abrasivi.

CAUTION Do not use any chemical or abrasive cleaning detergents or cloths/tools.

**Schrauben:**

Für einwandfreie, zuverlässige Funktion, Schrauben regelmässig nachziehen (z.B. vierteljährlich).

Vis:

Resserrer régulièrement les vis (p.ex. tous les 3 mois) pour assurer un fonctionnement sûr et correct.

Viti:

per garantire un funzionamento corretto e sicuro tirare regolarmente le viti (ad es. ogni tre mesi).

Screws:

To keep your furniture in good working order, tighten the screws regularly (e.g. every three months).

6. Entsorgung Élimination Smaltimento Disposal



<p>Entsorgungsservice: Micasa bietet Ihnen einen Entsorgungsservice an. Weitere Informationen erhalten Sie unter www.micasa.ch</p> <p>Entsorgung: Nicht mehr verwendete Möbel der fachgerechten Entsorgung übergeben. Wenden Sie sich an Ihre lokale Entsorgungsstelle.</p>	<p>Service d'élimination: Micasa vous propose un service d'élimination. Vous trouverez des informations supplémentaires sur www.micasa.ch</p> <p>Élimination: Veuillez remettre les meubles qui ne sont plus utilisés à une entreprise d'élimination. Adressez-vous à votre centre de collecte local.</p>	<p>Servizio di smaltimento: Micasa vi offre un servizio di smaltimento. Ulteriori informazioni sono disponibili su www.micasa.ch</p> <p>Smaltimento: i mobili dismessi devono essere conferiti presso i centri di raccolta rifiuti per il loro corretto smaltimento. Rivolgersi presso il centro di raccolta locale.</p>	<p>Disposal service: Micasa offers a disposal service. For more information visit www.micasa.ch</p> <p>Disposal: To correctly dispose of furniture that is no longer used, contact your local recycling centre.</p>
--	--	---	--

7. Kontakt / Service Contact / service Contatto / servizio Contact / service



<p>Fragen / Anregungen: Wir sind gerne für Sie erreichbar: Montag bis Freitag 08.00 bis 18.00 Uhr Samstag 08.30 bis 16.30 Uhr Tel. 0800 840 848</p>	<p>Questions / suggestions: Nous sommes à votre disposition: Lundi - vendredi 08h00 à 18h00 Samedi 08h30 à 16h30 Tél. 0800 840 848</p>	<p>Domande / suggerimenti: siamo a vostra disposizione: lunedì - venerdì dalle 08.00 alle 18.00 sabato dalle 08.30 alle 16.30 Tel. 0800 840 848</p>	<p>Questions / Suggestions Please contact us. Our opening times are: Monday - Friday 8.00 to 18.00 Saturday 8.30 to 16.30 Phone 0800 840 848</p>
---	--	---	--



<p>Ersatzteile: Erhalten Sie direkt im Online-Shop von Migros-Service: www.migros-service.ch</p>	<p>Pièces de rechange: Vous les obtenez directement dans le magasin en ligne de Migros-Service: www.migros-service.ch</p>	<p>Pezzi di ricambio: sono disponibili direttamente sull'online-shop di Migros-Service: www.migros-service.ch</p>	<p>Spare parts: Available directly from the Migros-Service online shop: www.migros-service.ch</p>
---	--	--	--